

---

# OWNER'S MANUAL

Operation  
Maintenance  
Specifications

All information in this Owner's Manual is current at the time of publication. However, Genesis Branded Vehicle reserves the right to make changes at any time so that our policy of continual product improvement may be carried out.

This manual applies to all models of this vehicle and includes descriptions and explanations of optional as well as standard equipment.

As a result, you may find material in this manual that does not apply to your specific vehicle.

Please note that some models are equipped with Right-Hand Drive (RHD). The explanations and illustrations for some operations in RHD models are opposite of those written in this manual.

### **CAUTION: MODIFICATIONS TO YOUR GENESIS BRANDED VEHICLE**

Your Genesis Branded Vehicle should not be modified in any way. Such modifications may adversely affect the performance, safety or durability of your Genesis Branded Vehicle and may, in addition, violate conditions of the limited warranties covering the vehicle. Certain modifications may also be in violation of regulations established by the Department of Transportation and other government agencies in your country.

### **TWO-WAY RADIO OR CELLULAR TELEPHONE INSTALLATION**

Your vehicle is equipped with electronic fuel injection and other electronic components. It is possible for an improperly installed/adjusted two-way radio or cellular telephone to adversely affect electronic systems. For this reason, we recommend that you carefully follow the radio manufacturer's instructions or consult your authorized retailer of Genesis Branded products for precautionary measures or special instructions if you choose to install one of these devices.

### **WARNING! (IF EQUIPPED)**

The vehicle is equipped with a device of the system Pan-european eCall which calls emergency services. Any self-or unauthorized interference in the system Pan-european eCall, in vehicle systems and its components, installing of equipment which is not recommended by vehicle manufacturer and/ or in authorized retailer of Genesis Branded products can cause incorrect operation (of the device of) the system Pan-european eCall, making erroneous calls, causing failure of the device (in cars) in case of traffic accident or other accidents, when you need emergency care.

This may be dangerous and threaten your life!

---

## SAFETY AND VEHICLE DAMAGE WARNING

This manual includes information titled as DANGER, WARNING, CAUTION and NOTICE.

These titles indicate the following:



### **DANGER**

**DANGER** indicates a hazardous situation which, if not avoided, will result in death or serious injury.



### **WARNING**

**WARNING** indicates a hazardous situation which, if not avoided, could result in death or serious injury.



### **CAUTION**

**CAUTION** indicates a hazardous situation which, if not avoided, could result in minor or moderate injury.

### **NOTICE**

**NOTICE** indicates a situation which, if not avoided, could result in vehicle damage.



## Table of contents

Foreword/Starting your electric vehicle	1
Vehicle information	2
Safety system	3
Instrument cluster	4
Convenience features	5
Driving your vehicle	6
Driver assistance system	7
Emergency situations	8
Maintenance	9
Index	I

# 1. Foreword/Starting your electric vehicle

Electric vehicle.....	1-6
Electric vehicle .....	1-6
Characteristics of electric vehicles .....	1-6
Battery Information.....	1-6
Main components of electric vehicle.....	1-7
Main components of electric vehicle .....	1-7
High voltage battery(lithium-ion battery) .....	1-7
High voltage battery warmer system.....	1-8
EV mode .....	1-9
EV mode screen .....	1-9
Energy information .....	1-10
Next departure .....	1-10
Charging and climate .....	1-11
Vehicle to load (V2L) .....	1-13
Nearby charging stations.....	1-19
EV settings.....	1-19
Charge types for electric vehicle.....	1-22
Charging Information.....	1-22
Charging time information .....	1-22
Charging types .....	1-23
Charge indicator lamp for electric vehicle.....	1-25
Charging status .....	1-25
Locking charging cable.....	1-26
Scheduled charging.....	1-27
Scheduled charging .....	1-27
Charging precautions .....	1-27
How to check the symbol on the charging label (For Europe).....	1-29
Electric charging label .....	1-30
Electric charging label symbol table.....	1-31
Disconnecting charging connector in emergency .....	1-32
AC charge .....	1-32
DC charge .....	1-36
Portable charge .....	1-39
Charging the electric vehicle (abrupt stop) .....	1-51
Action to be taken when charging stops abruptly.....	1-51

Driving electric vehicle .....	1-52
How to start the vehicle.....	1-52
How to shut off the vehicle .....	1-53
Virtual engine sound system .....	1-53
Distance to empty.....	1-54
Tips for improving distance to empty.....	1-55
Energy information .....	1-56
Power/Charge Gauge .....	1-57
State of charge (SOC) gauge for high voltage battery .....	1-57
Warning and Indicator lights (related to electric vehicle).....	1-58
LCD display messages .....	1-60
Aux. Battery Saver+ .....	1-65
Safety precautions for electric vehicle.....	1-66
If an accident occurs.....	1-66
Other precautions for electric vehicle .....	1-68
High voltage cut-off switch.....	1-68

## FOREWORD

Congratulations, and thank you for choosing Genesis Branded Vehicle. We are pleased to welcome you to the growing number of discerning people who drive Genesis Branded Vehicle. We are very proud of the advanced engineering and high-quality construction of each Genesis Branded Vehicle we build.

Your Owner's Manual will introduce you to the features and operation of your new Genesis Branded Vehicle. To become familiar with your new Genesis Branded Vehicle, so that you can fully enjoy it, read this Owner's Manual carefully before driving your new vehicle.

This manual contains important safety information and instructions intended to familiarize you with your vehicle's controls and safety features so you can safely operate your vehicle.

This manual also contains information on maintenance designed to enhance safe operation of the vehicle. It is recommended that all service and maintenance on your car be performed by an authorized retailer of Genesis Branded products. An authorized retailer of Genesis Branded products are prepared to provide high-quality service, maintenance and any other assistance that may be required.

This Owner's Manual should be considered a permanent part of your vehicle, and should be kept in the vehicle so you can refer to it at any time. The manual should stay with the vehicle if you sell it to provide the next owner with important operating, safety and maintenance information.

## GENESIS BRAND MOTOR COMPANY



### CAUTION

**Severe vehicle damage may result from the use of poor quality fuels and lubricants that do not meet Genesis Branded Vehicle specifications. You must always use high quality lubricants that meet the specifications listed on Page 2-14 in the Vehicle Specifications section of the Owner's Manual.**

Copyright 2022 Genesis Brand Motor Company. All rights reserved. No part of this publication may be reproduced, stored in any retrieval system or transmitted in any form or by any means without the prior written permission of Genesis Brand Motor Company.



## HOW TO USE THIS MANUAL

We want to help you get the greatest possible driving pleasure from your vehicle. Your Owner's Manual can assist you in many ways. We strongly recommend that you read the entire manual. In order to minimize the chance of death or injury, you must read the WARNING and CAUTION sections in the manual.

Illustrations complement the words in this manual to best explain how to enjoy your vehicle. By reading your manual, you will learn about features, important safety information, and driving tips under various road conditions.

The general layout of the manual is provided in the Table of Contents. Use the index when looking for a specific area or subject; it has an alphabetical listing of all information in your manual.

Sections: This manual has nine chapters plus an index. Each section begins with a brief list of contents so you can tell at a glance if that section has the information you want.

## SAFETY MESSAGES

Your safety, and the safety of others, is very important. This Owner's Manual provides you with many safety precautions and operating procedures. This information alerts you to potential hazards that may hurt you or others, as well as damage to your vehicle.

Safety messages found on vehicle labels and in this manual describe these hazards and what to do to avoid or reduce the risks.

Warnings and instructions contained in this manual are for your safety. Failure to follow safety warnings and instructions can lead to serious injury or death.

Throughout this manual DANGER, WARNING, CAUTION, NOTICE and the SAFETY ALERT SYMBOL will be used.



This is the safety alert symbol. It is used to alert you to potential physical injury hazards. Obey all safety messages that follow this symbol to avoid possible injury or death. The safety alert symbol precedes the signal words DANGER, WARNING and CAUTION.



### DANGER

**DANGER** indicates a hazardous situation which, if not avoided, will result in death or serious injury.



### CAUTION

**CAUTION** indicates a hazardous situation which, if not avoided, could result in minor or moderate injury.



### WARNING

**WARNING** indicates a hazardous situation which, if not avoided, could result in death or serious injury.

### NOTICE

**NOTICE** indicates a situation which, if not avoided, could result in vehicle damage.

## VEHICLE MODIFICATIONS

- This vehicle should not be modified. Modification of your vehicle could affect its performance, safety or durability and may even violate governmental safety and emissions regulations.  
In addition, damage or performance problems resulting from any modification may not be covered under warranty.
- If you use unauthorized electronic devices, it may cause the vehicle to operate abnormally, wire damage, battery discharge and fire.

### **NOTICE**

**Some warning sounds (including welcome/good-bye sound, etc.) are generated from the external amplifiers. If necessary, we recommend you to purchase Genesis/Hyundai Part to replace an external amplifier. Any unauthorized product may cause a malfunction of the external amplifiers.**

## RETURNING USED VEHICLES (FOR EUROPE)

Genesis Branded Vehicle promotes an environmentally sound treatment for end of life vehicles and offers to take back your Genesis Branded Vehicle end of life vehicles in accordance with the European Union (EU) End of Life Vehicles Directive.

You can get detailed information from your national Genesis Branded Vehicle homepage.

## ELECTRIC VEHICLE

### Electric vehicle

An electric vehicle is driven using a battery and an electric motor. While general vehicles use an internal combustion engine and gasoline as fuel, electric vehicles use electrical energy that is charged inside the high voltage battery. As a result, electric vehicles are eco-friendly in that they do not require fuel and do not emit exhaust gases.

### Characteristics of electric vehicles

1. It is driven using the electrical energy that is charged inside the high voltage battery. This method prevents air pollution since fuel, like gasoline, is not required, negating the emission of exhaust gases.
2. A high performance motor is used in the vehicle as well. Compared to standard, internal combustion engine vehicles, engine noise and vibrations are much more minimal when driving.
3. When decelerating or driving downhill, regenerative braking is utilized to charge the high voltage battery. This minimizes energy loss and increases the distance to empty.
4. When the battery charge is not sufficient, AC charge, DC charge and trickle charge are available. (Refer to “Charge Types for Electric Vehicle” for details.)

### Information

#### What does regenerative braking do?

**It uses an electric motor when decelerating and braking and transforms kinetic energy to electrical energy in order to charge the high voltage battery. (Torque is applied in the opposite direction when decelerating to generate braking force and electric energy.)**

### Battery Information

- The vehicle is composed of a high voltage battery that drives the motor and air-conditioner, and an auxiliary battery (12 V) that drives the lamps, wipers, and audio system.
- The auxiliary battery is automatically charged when the vehicle is in the ready (**READY**) mode or the high voltage battery is being charged.

## MAIN COMPONENTS OF ELECTRIC VEHICLE

### Main components of electric vehicle

- On-Board Charger (OBC): A device that charges the high voltage battery by converting AC power of the power grid to DC power.
  - Inverter: Transforms direct current into alternate current to supply power to the motor, and transforms alternate current into direct current to charge the high voltage battery.
  - LDC: Transforms power from the high voltage battery to low voltage (12 V) to supply power to the vehicle (DC-DC).
  - VCU: Control the various controls on the vehicle.
  - Motor: Uses electrical energy stored inside the high voltage battery to drive the vehicle (functions like an engine in a standard vehicle).
  - Reduction gear: Delivers rotational force of the motor to the tires at appropriate speeds and torque.
  - High voltage battery (lithium-ion battery): Stores and supplies power necessary for the electric vehicle to operate (12 V auxiliary battery provides power to the vehicle features such as lights and wipers).
- \* OBC: On-Board Charger  
 \* LDC: Low Voltage DC-DC Converter  
 \* VCU: Vehicle Control Unit



### WARNING

- **Do not intentionally remove or disassemble high voltage components and high voltage battery connectors and wires. Also, be careful not to damage high voltage components and the high voltage battery. It may cause serious injury and significantly impact the performance and durability of the vehicle.**
- **When inspection and maintenance is required for high voltage components and the high voltage battery, we recommend that you contact an authorized retailer of Genesis Branded products.**

### High voltage battery (lithium-ion battery)

- The charge amount of the high voltage battery may gradually decrease when the vehicle is not being driven.
- The battery capacity of the high voltage battery may decrease when the vehicle is stored in high/low temperatures.
- Distance to empty may vary depending on the driving conditions (such as outside temperature), even if the charge amount is the same. The high voltage battery may expend more energy when driving at high-speed or uphill. These actions may reduce the distance to empty.
- The high voltage battery is used when using the air-conditioner / heater. This may reduce the distance to empty. Make sure to set moderate temperatures when using the air-conditioner/heater.

- Natural degradation may occur with the high voltage battery depending on the number of years the vehicle is used. This may reduce the distance to empty.
- When the charge capacity and distance to empty keep falling, we recommend that you contact an authorized retailer of Genesis Branded products for inspection and maintenance.
- If the vehicle will not be in use for an extended period of time, charge the high voltage battery once every three months to prevent it from discharging. Also, if the charge amount is not enough, immediately charge to full and store the vehicle.
- AC charge is recommended to keep the high voltage battery in optimal condition.

If the high voltage battery charge amount is below 20 %, you can keep the high voltage battery performance in optimal condition if you charge the high voltage battery to 100 %. (Once a month or more is recommended.)

The value of the high voltage battery charge level may vary according to the charging conditions (state of charger, outside temperature, battery temperature, etc.). In order to fully charge the battery, the current of the high voltage battery will be gradually decreased, so that the longevity and safety of the battery can be secured.

 **CAUTION**

- **If the vehicle is kept with insufficient charge for a long period, it may damage the high voltage battery and the high voltage battery may have to be replaced depending on the level of degradation.**

- **If the vehicle is in a collision, we recommend that you contact an authorized retailer of Genesis Branded products to inspect whether the high voltage battery is still connected.**
- **Using the V2L function may reduce the mileage due to the use of high voltage battery energy, and repeated use of the V2L function may cause a decrease in the life of the high voltage battery.**
- **Using the V2L function may reduce the driving distance due to the use of high voltage battery energy, and repeated use of the V2L function may cause a decrease in the life of the high voltage battery.**

### High voltage battery warmer system

The high voltage battery warmer system prevents reduction of battery output when battery temperature is low. If the charging connector is connected, the warmer system automatically operates according to the battery temperature.

Charging time may shorten compare to vehicles without the high voltage battery warmer system. But, electricity charge may increase because of high voltage battery warmer system operation.

 **CAUTION**

**The high voltage battery warmer system operates when the charging connector is connected to the vehicle.**

**However, the high voltage warmer system may not operate when battery temperature drops below -35°C (-31°F).**

## EV MODE

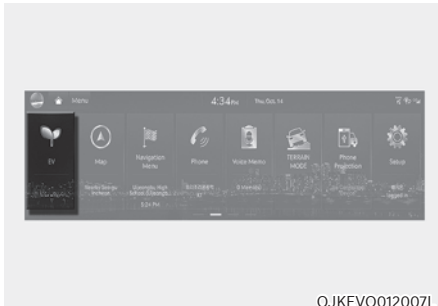

If you select the 'EV' menu at the home screen you can enter EV mode.

For detailed information, scan the QR code in a separately supplied simple manual.

## EV mode screen

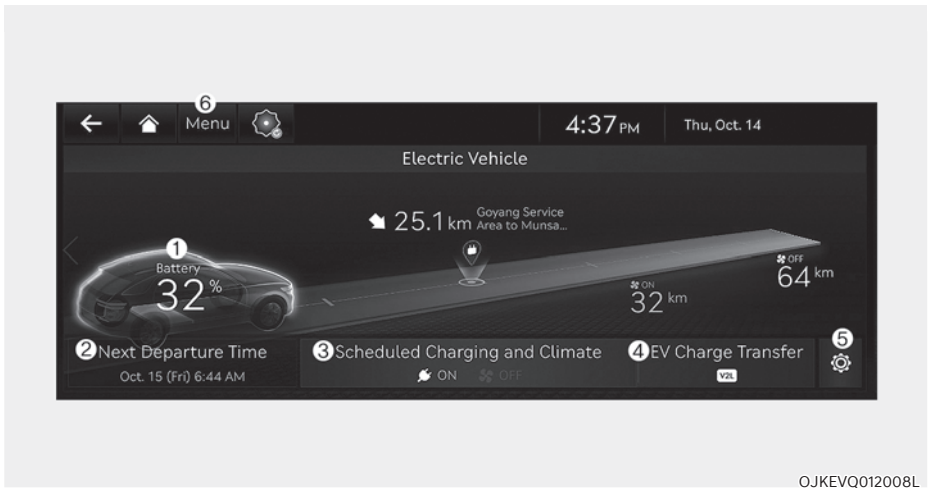

- (1) Energy Information
- (2) Next Departure
- (3) Charging and Climate

- (4) Vehicle to Load (V2L)
- (5) EV Settings
- (6) Menu

## Energy information

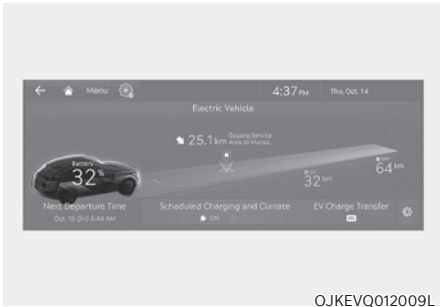

Select 'EV → Energy information' on the screen. You can check battery information and energy consumption.

### Battery information



You can check the reachable range, total battery power remaining, and expected charging time for each charge type.

- The distance to empty is calculated based on the electric energy efficiency while driving. The distance may change if the driving pattern changes.
- The distance to empty may vary according to the change of the driving pattern even if the same target battery charge level is set.

## Next departure

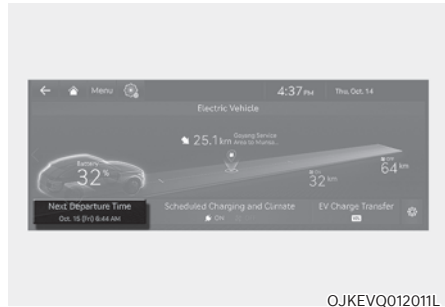

Select 'EV → Next departure time' on the screen. You can set the date and time of when to charge the battery, climate control temperature, and other various functions.

## Departure time

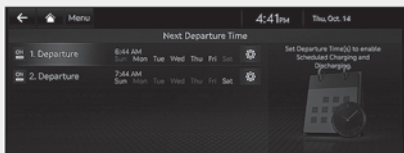

OJKEVQ012012L



OJKEVQ012013L

1. Set anticipated departure time for scheduled charging and target temperature.
2. Select the day of the week to activate scheduled charging and target temperature for departure time.

## Charging and climate

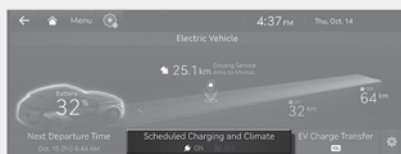

OJKEVQ012014L

Select 'EV → Scheduled charging and climate' on the screen.

### **i** Information

**Vehicle must be connected with the charging connector at the time pre-scheduled time for the scheduled charging.**

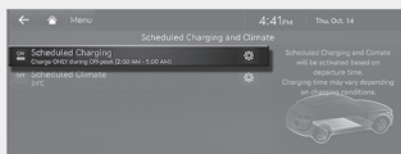

OJKEVQ012015L

You can set the date and time of when to charge the battery and the climate control temperature. Also, you may select the time to start charging using the off-peak time setting.



### Off-peak time settings

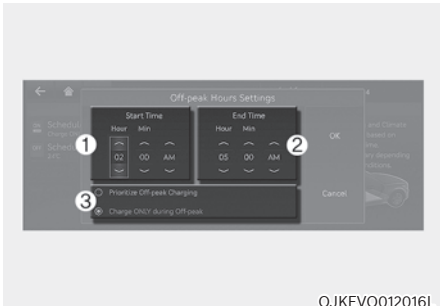

1. If selected, starts charging only on the designated off-peak time.
2. Set the most inexpensive time to complete charging.
3. You may select:
  - Off-peak tariffs prioritised: If selected, starts charging at off-peak time (may keep on charging pass off-peak time to charge 100 %).
  - Off-peak tariffs only: If selected, charges only within off-peak time (may not charge 100 %).

### Target temperature settings



1. Set target temperature.  
If the target temperature (1) is set with the cable connected, the cabin temperature will be adjusted to the target temperature at departure time (without loss of high voltage battery charging level). The target temperature control starts 30 minutes before the departure time. In cold weather, preschedule heating helps enhance electric vehicle performance by heating the vehicle in advance.

## Vehicle to load (V2L)

V2L is the system provides AC power using the high voltage battery for driving to operate several electrical products.

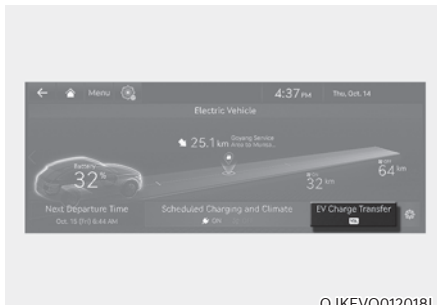

OJKEVQ012018L

Select 'EV → EV charge transfer' on the screen.

You can set the battery discharging limit for high voltage battery for driving.

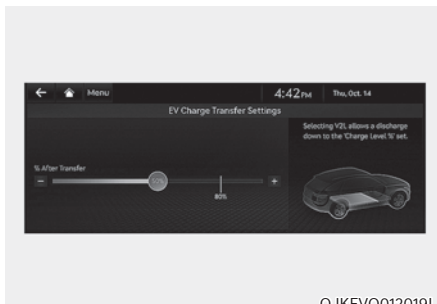

OJKEVQ012019L

If the vehicle reaches to the limit, it automatically cut supply of electricity.

## Energy information

Select 'EV → Energy information' on the screen.

You can check battery discharging level.

## How to connect

### Outdoor

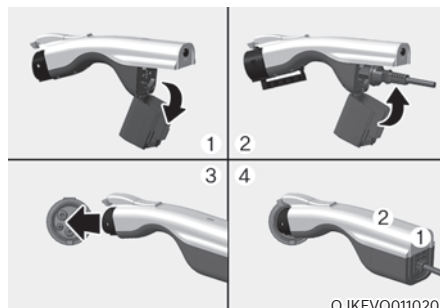

OJKEVQ011020

1. Open the cover of the V2L connector.
2. Close the cover after connecting home appliances and electrical products to the power outlet.
3. Connect the V2L connector to the charging inlet on the vehicle.
4. Press the switch (1) of the V2L connector and check whether the light (2) is on or off. The light (2) may not turn on normally when:
  - See the battery discharging limit for high voltage battery for driving in 'Electricity Use' menu on the screen. If it is higher than the current amounts of high voltage battery, the light (2) does not turn on.
  - Check whether the light of V2L connector turns on or not.

- If the warning message for V2L appears on the cluster, refer to the message entirely.
  - If V2L does not operate previously when you connects another home appliances, we recommend that you have your vehicle inspected by an authorized retailer of Genesis Branded products.
5. Press the switch (1) to turn off the light (2) the the V2L will be off. You can disconnect the V2L connector when the light (2) turns off or the charging connector lock is deactivated pressing the door unlock button on the smart key.

**i** Information

- **Please connect the V2L connector to the charging inlet within 60 seconds after the charging cover opens. To prevent theft after connecting, it is changed to auto lock automatically so that it is impossible to disconnect.**
- **When using V2L, cancel the scheduled air conditioning setting. V2L operation may be blocked by scheduled air conditioning operation conditions.**

**Indoor (if equipped)**



1. Connect to the power outlet located on the lower right side of the tailgate with the Vehicle Stop/Start button in the ON position.



2. Use the smart key to unlock the power outlet cover.

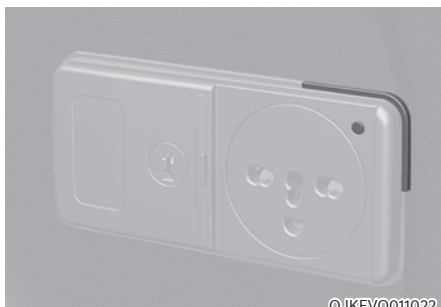

3. Check the operation status through the front indicator of the power outlet.

- Blue: Standby
- Red: No power supply even the power outlet is connected
- Green: Normal power supply through the normal connection of the power outlet.

### **i** Information

- **V2L discharging mode will shut off if the vehicle is off using indoor V2L on the vehicle state of ON.**
- **Opening the charging door or connecting the V2L connector to the charging inlet, the V2L discharging mode will shut off. If you want to use the indoor and outdoor V2L simultaneously, firstly connect the V2L connector to the charging inlet and use the indoor V2L.**

### **⚠** CAUTION

- **Be well-informed of the manual to prevent accidents.**
- **The V2L discharging mode is blocked automatically in case of overheating. (When the discharging mode is blocked, check whether the V2L connector or power plug is contaminated, worn, corroded or broken or the home appliance capacity is over 16 A. If the temperature falls to proper level after it is left unattended, you can use it again. Use proper home appliances.)**
- **Do not remodel or disassemble the provided V2L connector. The failure caused by remodeling or disassembling is not covered by the warranty.**
- **Do not drop the V2L connector or give a strong impact to it.**
- **Do not place objects on the V2L connector.**
- **Be sure to disconnect the V2L connector from the vehicle when you are finished using V2L.**
- **When the high voltage battery charge reaches the set discharging limit (%), the operation stops, and a warning message is displayed on the instrument panel. If you want V2L operation, set the discharging limit (%) lower than the current battery charge.**
- **When using various electric products, use them below the maximum power capacity that can be supplied by the vehicle.**

- If you use an electrical appliance that exceeds the maximum power capacity that the vehicle can supply, the operation will stop and a warning message will be displayed on the instrument panel. Make sure the total power consumption of the electrical appliance you use exceeds the V2L maximum power capacity.
- Some of the electric products may not operate normally even if the product has power consumption less than the maximum power capacity provided by the vehicle.
  - Electrical products that require high power during initial operation.
  - Measuring devices that need to process accurate data.
  - Electrical products that are sensitive to inverter type AC charger. (inverter: AC power is supplied through power semiconductor switching)
- Do not use products that require a continuous power supply, such as medical equipment. The power supply may be interrupted depending on the vehicle's condition.
- Only use home appliances under 16 ampere.
- Insert the power plug fully and use the qualified plug that meets the standard. If you use worn, corroded or broken plug or improper plug, it might be a cause of malfunction.
- Use a power plug with ground connection.
- Do not use high power home appliances such as air conditioning, washing machine or dryer.
- Do not hang the home appliances on to the wire.
- For various devices connected to an power outlet, use only products that have obtained national safety certification. For usage and precautions, refer to the manual of the device. (Electrical appliances, multi-outlets, cord extension cables, etc.)
- For devices used outdoors in a vehicle, use a product with a waterproof function or use it in a waterproof environment. Do not use in environments with rain or high humidity. (Electrical appliances, multi-outlets, cord extension cables, etc.)
- If there is a risk of lightning, do not use the V2L function outside the vehicle.
- Do not connect multiple portable multi-outlets.
- When using an extension cable, if the cable is twisted or overlapped by itself may cause a fire. Be sure to use the cable without twisting it.
- When using the vehicle's outdoor V2L connector, power is also supplied to the vehicle's indoor power outlet. Unplug electrical appliances that are not in use from the indoor power outlet.
- When using the V2L, the cooling fan in the vehicle motor compartment can operate automatically even if the vehicle is turned off. Do not put your hand near the cooling fan in the V2L operating state.



**WARNING**

- Do not touch the V2L connector of the terminal of the vehicle charging inlet.
- Do not put metal objects to the V2L connector or charging inlet. It might be a cause of electric shock.
- Do not touch the V2L connector, charging inlet or power plug with a wet hand. It might be a cause of electric shock. Please handle with a dry hand all the time.
- Confirm whether there is foreign substance such as water or dust on the V2L connector, charging inlet or power plug before connecting. If you connect it with foreign substances, it may be a cause of fire or electric shock.

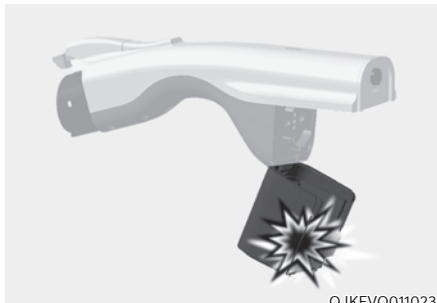
- Do not remodel or disassemble the V2L connector. There is a risk of fire, electric shock or injury.



OJKEVQ011023

- When the power plug is connected or disconnected to the V2L connector or open or close the connector cover of the V2L, be careful not to be scratched on the hand.
- Do not charge in the following conditions. The accident might occur.
  - The V2L connector, charging inlet, power plug or cable is damaged, corroded or rusted.
  - The connection part is loose.
- Do not use if the sheath of home appliance cables is damaged or broken. There is a risk of fire, electric shock or injury.
- Never use an electric heating appliance like iron, coffee pot, and toaster in the vehicle. It may cause a fire and injury.
-  When using the V2L, the cooling fan in the vehicle motor compartment can operate automatically even if the vehicle is turned off. Do not put your hand near the cooling fan in the V2L operating state.

### LCD display messages

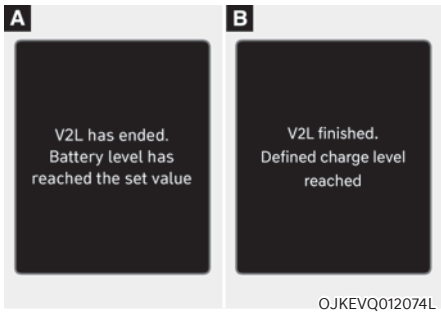

#### V2L has ended. Battery level has reached the set value/V2L finished. Defined charge level reached

When the high voltage battery level reaches the discharging limit set level, the V2L will stop and the warning will be displayed. If you want to use the V2L continuously, make the discharging limit set level lower than the present battery level.

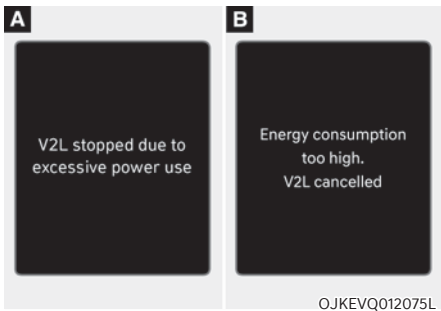

#### V2L stopped due to excessive power use/Energy consumption too high. V2L cancelled

If you use an electrical appliance that exceeds the maximum power output the vehicle can supply, it will stop working and display a warning message. Make sure that the total power consumption of your electrical appliance exceeds the V2L maximum power output.



#### V2L conditions not met

If V2L is interrupted for any of the following reasons, a warning message is displayed.

- V2L connector switch off
- V2L connector overheating
- Opening the charging door while using the V2L indoor outlet

Make sure there are no problems with the V2L connector and the vehicle indoor outlet.

## Nearby charging stations

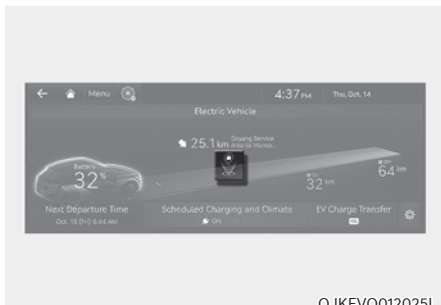

OJKEVQ012025L

Select 'Nearby Stations' on the screen.

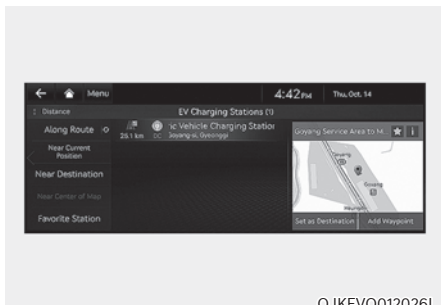

OJKEVQ012026L

Around the course, around the current site, around the selected destination or charging stations of interest will be searched. If you choose the charging station, the detailed information will be provided.

For detailed information, scan the QR code in a separately supplied simple manual.

## EV settings

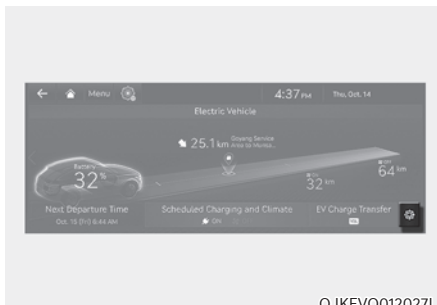

OJKEVQ012027L

Select 'EV → EV Settings' on the screen. You can set the charging limit, charging current, battery conditioning mode and utility mode functions.

### Charging limit (Max. % Charge)

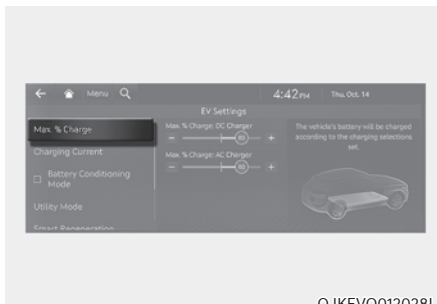

OJKEVQ012028L

- The target battery charge level can be selected when charged with AC charger or DC charger.
- The charging level can be changed by 10%.
- If the target battery charge level is lower than the high voltage battery charge level, the battery will not be charged.



### Charging current

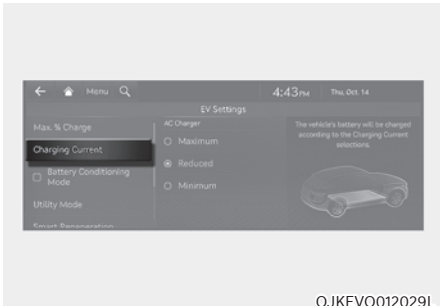

- You can adjust the charging current for an AC charger. Select an appropriate charging current.
- If the charging process does not start or abruptly stops in the middle, reselect another proper current and re-try charging the vehicle.
- Charging time varies depending on which charging current is selected.

### Battery conditioning mode

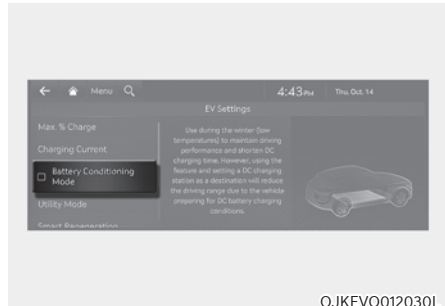

You can select or deselect the Battery conditioning mode.

The Battery conditioning mode is efficient during the winter time when the high voltage battery temperature is low. This mode is recommended to improve driving and DC charging performances during winter by raising the battery temperature to an adequate level.

However, the driving distance may be reduced as the energy is required to increase battery temperature.

Also, if the battery temperature is low during driving or when the scheduled air conditioner/heater is activated, this mode is operated to improve driving performance.

However, the mode is not operated to ensure driving distance when the battery level is low.

#### Information

**This mode is available for the vehicles equipped with the battery heater.**

## Utility Mode

The high voltage battery is used instead of the 12 V auxiliary battery for operating the convenient features of the vehicle. When driving is not necessary such as while camping or when stopping the vehicle for a long time, it is possible to use the electrical devices (audio, lights, air conditioner, heater, etc.) for long hours.

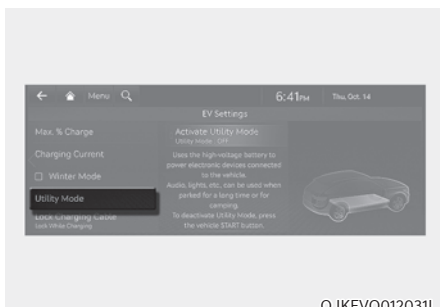

OJKEVQ012031L

## System Setting and Activation

### System setting

The driver can activate the Utility mode function when the following conditions are satisfied.

- The vehicle is in the ready (**READY**) mode and the gear is shifted to P (Park).
- The EPB (Electronic Parking Brake) is not malfunctioning.
- 'EV Settings→Utility Mode' is selected on the infotainment system screen.

## System Activation

When the system is activated:

- The ready (**READY**) indicator will turn off, and the utility (**UTIL**) indicator will illuminate on the cluster and the EPB is applied.
- All electric devices are usable but the vehicle cannot be driven.
- The EPB can be cancelled by pressing the EPB switch.

Gear cannot be shifted out of P (Park). If a shift attempt is made, a message "Shifting conditions not met" will be displayed on the infotainment system screen.

## System Deactivation

The Utility mode can be deactivated by pressing the START/STOP button to the OFF position. The function cannot be deactivated from the EV settings.

## CHARGE TYPES FOR ELECTRIC VEHICLE

### Charging Information

- AC Charge: The electric vehicle is charged by plugging into a AC charger installed at your home or a public charging station. (For further details, refer to the 'AC Charge'.)
- DC Charge: You can charge at high speeds at public charging stations. Refer to the respective company's manual that is provided for each DC charger type.

Battery performance and durability can deteriorate if the DC charger is used constantly.

Use of DC charge should be minimized in order to help prolong high voltage battery life.

- Portable Charge: The Electric vehicle can be charged by using household electricity. The electrical outlet at your home must comply with regulations and can safely accommodate the Voltage/Current (Amps)/Power (Watts) ratings specified on the portable charge.







### Charging time information

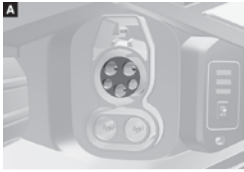
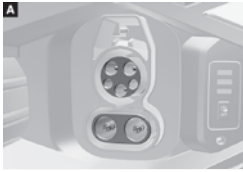
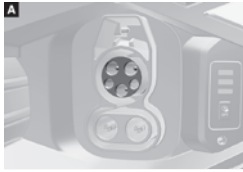
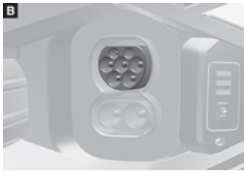
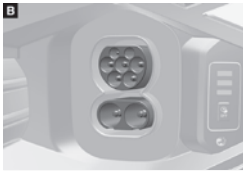
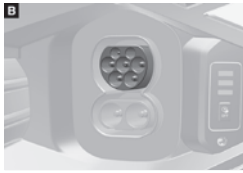
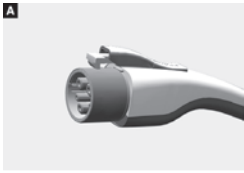

Charging type	Standard battery type	
AC charge	Takes approx. 7 hours 20 minutes at room temperature when charged to 100%	
DC charge	350 kW charger	Takes about 18 minutes at room temperature when charged from 10% to 80%. Can be charged to 100%.
	50 kW charger	Takes about 73 minutes at room temperature when charged from 10% to 80%. Can be charged to 100%.
Portable charge	Takes approx. 32 hours 45 minutes at room temperature when charged to 100%.	

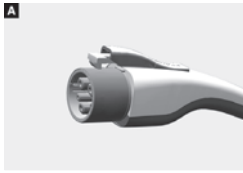
### Information

**Depending on the condition and durability of the high voltage battery, charger specifications, and ambient temperature, the time required for charging the high voltage battery may vary.**

## Charging types

Category	AC Charge	DC Charge	Portable Charge
Charging Inlet (Vehicle)	 <p>OJKEVQ012086L</p>	 <p>OJKEVQ012087L</p>	 <p>OJKEVQ012086L</p>
	 <p>OJKEVQ012089L</p>	 <p>OJKEVQ012090L</p>	 <p>OJKEVQ012089L</p>
	 <p>OJKEVQ012073L</p>	 <p>OJKEVQ012092L</p>	 <p>OJKEVQ012073L</p>
	 <p>OJKEVQ012094L</p>	 <p>OJKEVQ012095L</p>	 <p>OJKEVQ012094L</p>

Category	AC Charge	DC Charge	Portable Charge
Charging Outlet	 <p>ORG3EVQ011071</p>	 <p>OSQCEQ019005</p>	 <p>ONX4EPHQ011019L</p>
How to Charge	Use AC charger installed at home or public charging stations	Use the DC charger at public charging stations	Use household current

- Depending on the condition and durability of the high voltage battery, charger specifications, and ambient temperature, the time required for charging the high voltage battery may vary.
- Actual charger image and charging method may vary in accordance with the charger manufacturer.

## CHARGE INDICATOR LAMP FOR ELECTRIC VEHICLE

When charging the high voltage battery, the charge level can be checked from outside the vehicle.





### Charging status

#### Electric charging door



©ORG3EVQ011031

### 1. Charging status

Lamp status	Details
 yellow	High voltage battery level very low
 green	High voltage battery level low
 green	High voltage battery level middle
 green	High voltage battery level high

### 2. Immediate charging

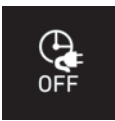
Lamp status	Details
	Scheduled charging deactivation button. Press 2 seconds to charge immediately.

## Locking charging cable



OJKEVQ012032L

You may select when the charging connector can be locked and unlocked in the charging inlet.

Select 'EV → Charging Connector Locking Mode' in the infotainment.

### **i** Information

- **The charging inlet is locked during the DC charge regardless of 'Always lock'/'Locking while charging' mode. After charging is complete the locked charging inlet is unlocked.**
- **The charging inlet locks when the V2L connector is connected, regardless of the settings of charging connector locking.**

**After use, the lights can be turned off by pressing the switch on the V2L connector, and the charging inlet can be unlocked by pressing the vehicle door unlock button.**

## When the Charging Connector Is Locked

	Always lock	Lock while charging	Do not lock (if equipped)
Before charging	O	X	X
While charging	O	O	X
Finished charging	O	X	X

- **'Always lock' mode:**  
The connector locks when the charging connector is plugged into the charging inlet. The connector is locked until all doors are unlocked by the driver. This mode can be used to prevent charging cable theft.
  - The charging connector unlocks when all doors are unlocked. If the charging cable is not disconnected within 15 seconds, it will automatically lock again.
  - If the charging connector is unlocked when all doors are unlocked, but all doors are locked again, immediately, the connector will be automatically locked again.
- **'Lock while charging' mode:**  
The connector locks when charging starts. The connector unlocks when charging is complete. This mode can be used when charging in a public charging station.
- **'Do not lock' mode (if equipped):**  
The connector unlocks regardless of the state of charging. Press the charging connector release button, disconnect the connector. Be careful of charging cable theft.

## SCHEDULED CHARGING

### Scheduled charging (if equipped)

- You can set-up a charging schedule for your vehicle using the Infotainment system or Genesis Connected Service application. Refer to the Multimedia manual or the Genesis Connected Service for detailed information about setting scheduled charging.
- Scheduled charging can only be done when using a AC charger or the portable charger (ICCB: In-Cable Control Box).



- When scheduled charging is set and the AC charger or the portable charger (ICCB: In-Cable Control Box) is connected for charging, the indicator lamp illuminates (1) for 3 minutes to indicate that scheduled charging is set.
- When scheduled charging is set, charging is not initiated immediately when the AC charger or portable charger (ICCB: In-Cable Control Box) is connected. When immediate charging is required, use the Audio or Navigation screen to deactivate the scheduled charge setting or press schedule charging deactivation button (2) for 2 seconds.

- If you press the scheduled charging deactivation button (2) to immediately charge the battery, charging must be initiated 3 minutes after the charging cable has been connected. When you press the scheduled charging deactivation button (2) for immediate charging, the scheduled charge setting is not completely deactivated. If you need to completely deactivate the scheduled charge setting, use the Audio or Navigation screen to finalize the deactivation.

Refer to “AC Charge (Station) or Trickle Charge” for details about connecting the AC charger and the portable charger (ICCB: In-Cable Control Box).

### Charging precautions



[A]: AC Charger, [B]: DC Charger

Actual charger image and charging method may vary in accordance with the charger manufacturer.





### **WARNING**

- Electromagnetic waves that are generated from the charger can seriously impact medical electric devices such as an implantable cardiac pacemaker.  
If you are fitted with any electronic medical implants (for example, cardiac pacemaker), make sure to ask the medical team and manufacturer whether charging your electric vehicle will impact the operation of electronic medical implants.
- Check to make sure there is no water or dust on the charging cable connector and plug before connecting to the charger and charging inlet. Connecting while there is water or dust on the charging cable connector and plug may cause a fire or electric shock.



### **WARNING**

- Be careful not to touch the charging connector, charging plug, and the charging inlet when connecting the cable to the charger and the charging inlet on the vehicle.
- Comply with the following in order to prevent electrical shock when charging:
  - Use a waterproof charger.
  - Do not touch the charging connector and charging plug with your hands wet, or do not stand in water or snow while connecting the charging cable.
  - Be careful when there is lightning.
  - Be careful when the charging connector and plug are wet.



### **WARNING**

- Immediately stop charging when you find abnormal symptoms (odor, smoke).
- Replace the charging cable if the cable coating is damaged to prevent electrical shock.
- When connecting or removing the charging cable, make sure to hold the charging connector handle and charging plug.

If you pull the cable itself (without using the handle), the internal wires may be disconnected or get damaged. This may lead to electric shock or fire.



## CAUTION

- Always keep the charging connector and charging plug in clean and dry condition. Be sure to keep the charging cable in a condition where there is no water or moisture.
- Be sure to use only certified electric vehicle charger. Using uncertified charger may cause the damage to the vehicle.
- Before charging the battery, turn the vehicle OFF.
- When the vehicle is switched OFF while charging, the cooling fan inside the motor compartment may automatically operate. Do not touch the cooling fan while charging.
- Be careful not to drop the charging connector. The charging connector can be damaged.

## How to check the symbol on the charging label (For Europe)

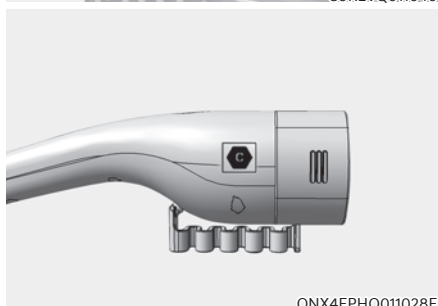

Charging label is located near charging inlet and you can find the suitable symbol for your vehicle type in the charging connector outlet.

### Precautions for AC and portable charger charging

1. After opening the charging door, check the charging symbol at the bottom of the warning label.
2. Check the charging connector symbol of the AC and Trickle charger cable.
3. After checking the alphabet letter of the charging symbol, proceed the charging step (Refer to “Electric charging label symbol table” in this chapter).

### Precautions for DC charging

1. After opening the charging door, check the charging symbol at the bottom of the warning label.
2. Check the charging connector symbol at the high speed charging station.
3. After checking the alphabet letter of the charging symbol, proceed the charging step (Refer to Electric charging label symbol table in this chapter).



### WARNING

**Risk of failure, fire, injury, etc., are expected when using the charging connector with unmatched symbol.**

### Electric charging label



ONE1Q011080L



1. Warning for high voltage
2. Symbol for charging door
3. For further details, refer to “How to check the symbol on the charging label ” in this chapter.
4. Charging voltage and current  
~ : AC single phase  
≡ : AC 3 phase
- 5, 6, 7. Symbols for charging type. Refer to “Electric charging label symbol table”.

## Electric charging label symbol table

### *AC and portable charger charging*

Supply Type	Configuration	Type of accessory	Voltage range	Symbol
AC	7P	Vehicle connector and vehicle inlet	≤480V RMS	

### *DC charging*

Supply Type	Configuration	Type of accessory	Voltage range	Symbol
DC	7P COMBO	Vehicle connector and vehicle inlet	50 V to 500 V	
			200 V to 920 V	

### Disconnecting charging connector in emergency

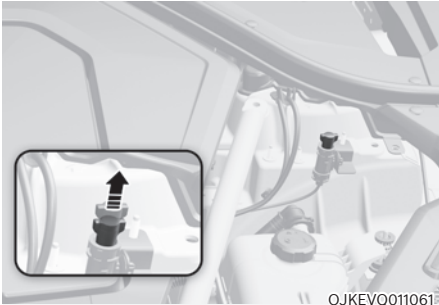

OJKEVQ011061

If the charging connector does not disconnect from the charging inlet due to battery discharge and failure of electric wires, open the hood and slightly pull the emergency cable. The charging connector will be disconnected from the charging inlet.

### AC charge



ORG3EVQ011071

Actual charger image and charging method may vary in accordance with the charger manufacturer.

### How to Connect AC Charger

1. Depress the brake pedal and apply the parking brake.
2. Turn OFF all switches, shift to P (Park), and turn OFF the vehicle.

If charging is initiated without the gear in P (Park), the charging will start after the gear is automatically shifted to P (Park).

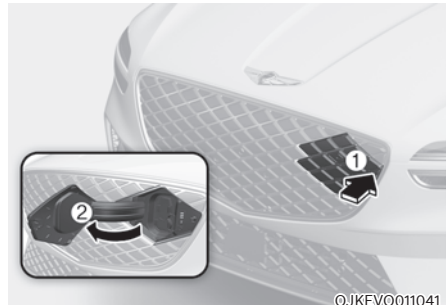

OJKEVQ011041

3. Push the charging door where the triangle symbol (1) is located to open. The charging door opens only when the vehicle is unlocked.
4. Open the inlet cover (2).

### **i** Information

**If you cannot open the charging door due to freezing weather, tap lightly or remove any ice near the charging door. Do not try to forcibly open the charging door.**

5. Check if there is dust on the charging connector and charging inlet.
6. Hold the charging connector handle and connect it to the vehicle charging inlet. Push the connector all the way in. If the charging connector and charging terminal are not connected properly, this may cause a fire and charging may not start.

### **i** Information

#### Locking Charging Cable

Select 'EV → Charging Connector Locking Mode' in the infotainment system menu. The charging connector will lock to the inlet depending upon the locking mode selected within the infotainment.

- **Always mode** : The connector locks when the charging connector is plugged into the charging inlet.
- **While charging mode** : The connector locks when charging starts.

For more details, refer to "Locking Charging Cable" in this chapter.

7. Connect the charging plug to the electric outlet at an AC charging station to start charging.

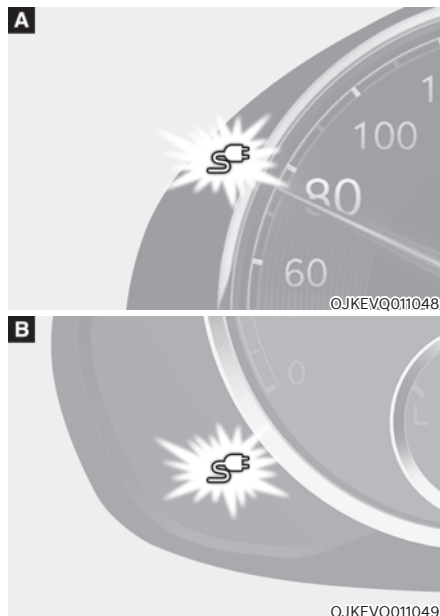

8. Check if the charging indicator light (⚡) of the high voltage battery on the instrument cluster is turned ON. Charging is not active when the charging indicator light (⚡) is OFF. If the charging cable is not connected to the vehicle side inlet properly, charging may not start. In this case, try reconnecting charging cable to the vehicle inlet again.

### **i** Information

To control the temperature of the high voltage battery while charging or when the battery temperature is high, the air conditioning is used to cool down the battery. This may generate noise or vibration from operation of the air conditioning compressor and cooling fan, but it is a normal condition when charging the high voltage battery. Also, the air conditioning performance may be reduced due to operation of the cooling system to charge the high voltage battery. This is a normal condition.

**i** Information

- **Even though charging is possible with the Start/Stop button in the ON/START position, for your safety, start charging when the Start/Stop button is in the OFF position and the vehicle shifted to P (Park). After charging has started, you can use electrical components such as the radio by pressing the Start/Stop button to the ACC or ON position.**
- **During AC charging, the radio reception may be poor.**
- **During charging, the gear cannot be shifted from P (Park) to any other gear.**

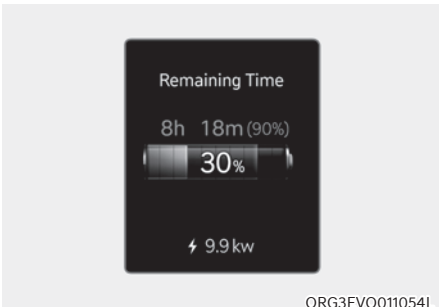

ORG3EVQ011054L

9. After charging has started, the estimated charging time is displayed on the instrument cluster for about 1 minute.

If you open the driver's door while charging, the estimated charging time is also displayed on the instrument cluster for about 1 minute. When scheduled charging or scheduled air conditioning/heating is set, the estimated charging time is displayed as "--".

**i** Information

**Depending on the condition and durability of the high voltage battery, charger specifications, and ambient temperature, the time required for charging the battery may vary.**

**Checking Charging Status**

When charging the high voltage battery, the charge level can be checked from outside the vehicle.

For more details, refer to 'Charge Indicator Lamp for Electric Vehicle' in this chapter.

**How to Disconnect AC Charger**



ORG3EVQ011071

1. When charging is complete, remove the charging plug from the electrical outlet of the AC charging station.

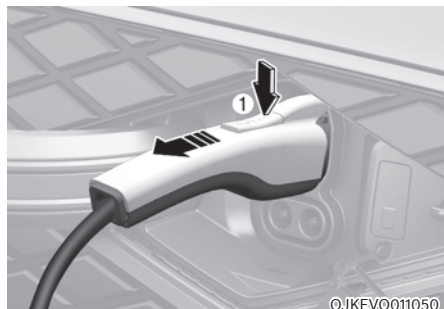

OJKEVQ011050

2. Press release button (1), then remove charging connector from the vehicle inlet.

### **i** Information

To prevent charging cable theft, the charging connector cannot be disconnected from the inlet when the doors are locked or the charging connector is in the 'Locking while charging' mode. Unlock all doors to disconnect the charging connector from the inlet.

However, if the vehicle is in the charging connector 'Always lock' mode, the charging connector automatically unlocks from the inlet when charging is completed.

If you attempt to disconnect the charging connector without pressing the release button, the connector and the inlet may be damaged. For more details, refer to "Charging Connector 'Always lock'/'Locking while charging' Mode" in this chapter.

If the release button does not work even after the all doors are unlocked, pull the emergency lift cable in the motor room and press the release button in the connector to disconnect it from the vehicle. If the release button still does not work, we recommend to consult an authorized retailer of Genesis Branded products.

### **i** Information

Some connectors installed in public charging stations stop charging by pressing the charge release button while charging is locked, and the connector can be disconnected.

3. Make sure to completely close the charging door.
4. Close the protection caps of the charging connector and the charging plug to protect them from foreign substances.
5. If the personal charging connector is used, store the connector in the cable compartment.



## DC charge



You can charge at high speeds at public charging stations. Refer to the respective company's manual that is provided for each DC charger type.

Battery performance and durability can deteriorate if the DC charger is used constantly.

Use of DC charge should be minimized in order to help prolong high voltage battery life.

**Actual charger image and charging method may vary in accordance with the charger manufacturer.**

### **i** Information

**If you use a DC charger when the vehicle is already fully charged, some DC chargers will send out an error message. When the vehicle is fully charged, do not charge the vehicle.**

## **How to Connect DC Charger**

1. Depress the brake pedal and apply the parking brake.
2. Turn OFF all switches, shift to P (Park), and turn OFF the vehicle.

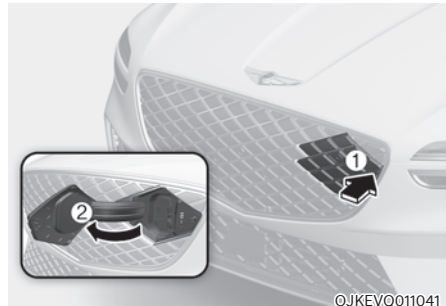

3. Push the charging door where the triangle symbol (1) is located to open. The charging door opens only when the vehicle is unlocked.
4. Open the inlet cover (2).

### **i** Information

**If you cannot open the charging door due to freezing weather, tap lightly or remove any ice near the charging door. Do not try to forcibly open the charging door.**

5. Check whether there is dust or foreign substances inside the charging connector and charging inlet.
6. Hold the charging connector handle and connect it to the vehicle charging inlet. Push the connector all the way in. If the charging connector and charging terminal are not connected properly, this may cause a fire and charging may not start.

Refer to the manual for each type of DC charger for how to charge and remove the charger.

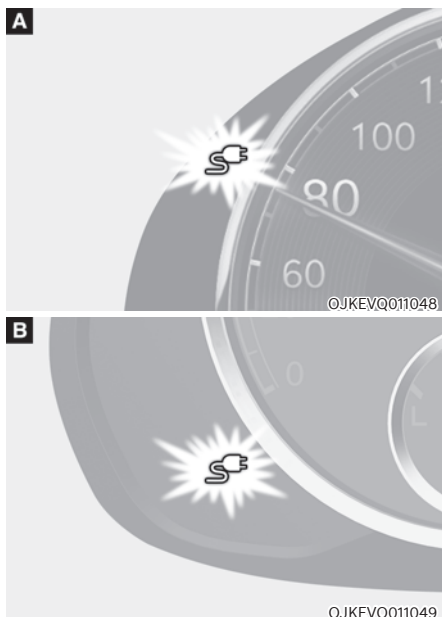

7. Check if the charging indicator light (S) of the high voltage battery in the instrument cluster is turned ON. Charging is not active when the charging indicator light (S) is OFF.

When charging cable is not connected properly to inlet, press release button, remove charging cable and reconnect again.

During cold weather, DC charging may not be available to prevent high voltage battery degradation.

### **i** Information

To control the temperature of the high voltage battery while charging or when the battery temperature is high, the air conditioning is used to cool down the battery. This may generate noise or vibration from operation of the air conditioning compressor and cooling fan, but it is a normal condition when charging the high voltage battery. Also, the air conditioning performance may be reduced due to operation of the cooling system to charge the high voltage battery. This is a normal condition.

### **i** Information

- Even though charging is possible with the Start/Stop button in the ON/START position, for your safety, start charging when the Start/Stop button is in the OFF position and the vehicle shifted to P (Park). After charging has started, you can use electrical components such as the radio by pressing the Start/Stop button to the ACC or ON position.
- During charging, the gear cannot be shifted from P (Park) to any other gear.



8. After charging has started, the estimated charging time is displayed on the instrument cluster for about 1 minute.
- If you open the driver seat door while charging, the estimated charging time is also displayed on the instrument cluster for about 1 minute.

### **i** Information

- Depending on the condition and durability of the high voltage battery, charger specifications, and ambient temperature, the time required for charging the battery may vary.
- In rare cases, you might hear high frequency noise (very little beep sound) outside the car when charging with 400 V DC charger that is deteriorated or has long communication delay. The high frequency noise can be generated only when the vehicle tries to reduce its own electromagnetic waves to keep DC charging as possible.

**Do not worry about this little beep noise, because it is the intentional operation of the car that does not affect any charging performance or the vehicle itself at all.**

### **Checking Charging Status**

When charging the high voltage battery, the charge level can be checked from outside the vehicle.

For more details, refer to 'Charge Indicator Lamp for Electric Vehicle' in this chapter.

### **How to Disconnect DC Charger**

1. Press release button and then remove charging connector when DC charging is completed, or after you stop charging using the DC charger. Refer to each respective DC charger manual for details about how to disconnect the charging connector.
2. Make sure to completely close the charging door.

## Portable charge

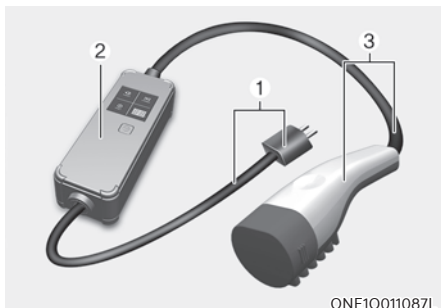

- (1) Code and Plug (Code set)
- (2) Control Box
- (3) Charging Cable and Charging Connector

Portable Charge can be used when AC Charge or DC Charge is not available by using household electricity.

### *How to Set the Charge Level of the Portable Charger*

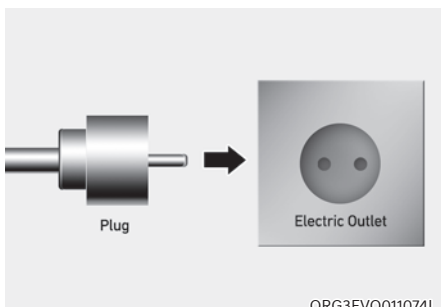

1. Check the rated current of the electric outlet prior to connecting the plug to the outlet.
2. Connect the plug to a household electric outlet.
3. Check the display window on the control box.



4. Press the button (1) on the front of the control box for 2 to 8 seconds to adjust the charge level. (Refer to charging cable type and example for setting the charge level.)
5. The charge level on the display window of the control box changes every time you press the button (1).
6. When setting the charge level is complete, start charging according to the portable charge instructions.

\* Example for setting the ICCB charge level

The example is only for reference and may vary according to the surrounding environment.

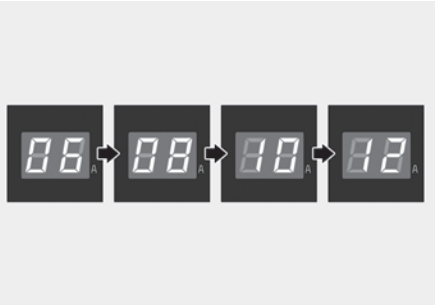
Outlet current	ICCB charge level	Control box display window
14-16 A	12 A	 <p style="text-align: right; font-size: small;">ORG3EVQ011076</p>
13-12 A	10 A	
11-10 A	8 A	
9-8 A	6 A	

 **CAUTION**

Please make sure that charge level selection matches the capacity of your circuit breaker to avoid blown fuse.

### How to Connect Portable Charger (ICCB: In-Cable Control Box)

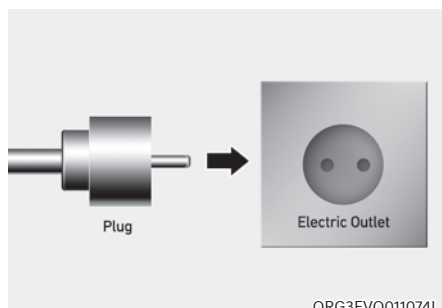

1. Connect the plug to a household electric outlet.



2. Check if the power lamp (green) illuminates on the control box.
3. Depress the brake pedal and apply the parking brake.
4. Turn OFF all switches, shift to P (Park), and turn OFF the vehicle.

If charging is initiated without the gear in P (Park), the charging will start, only after the gear is shifted to P (Park).

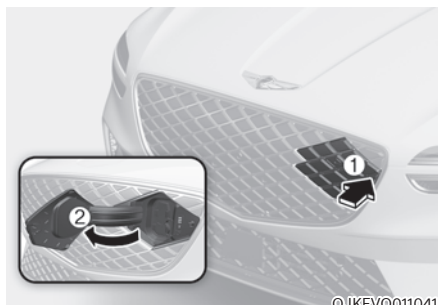

5. Push the charging door where the triangle symbol (1) is located to open. The charging door opens only when the vehicle is unlocked.

### **i** Information

**If you cannot open the charging door due to freezing weather, tap lightly or remove any ice near the charging door. Do not try to forcibly open the charging door.**

6. Open the protection caps of the charging connector and the charging plug. Check if there are any foreign substances or dust.
7. Hold the charging connector handle and connect it to the vehicle charging inlet. Push the connector all the way in. If the charging connector and charging terminal are not connected properly, this may cause a fire and charging may not start.

**i** Information

**Locking Charging Cable**

Select ‘EV → Charging Connector Locking Mode’ in the infotainment. The charging connector will lock to the inlet depending upon the locking mode selected within the infotainment.

- Always mode : The connector locks when the charging connector is plugged into the charging inlet.
- While charging mode : The connector locks when charging starts.

For more details, refer to “Locking Charging Cable” in this chapter.



8. Charging starts automatically (charging lamp illuminates).

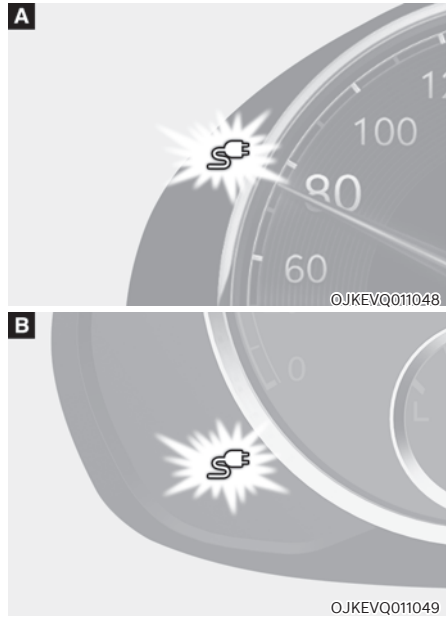

9. Check if the charging indicator light (⚡) of the high voltage battery in the instrument cluster is turned ON. Charging is not active when the charging indicator light (⚡) is OFF. When charging cable is not connected properly to inlet, press release button, remove charging cable and reconnect again.

### **i** Information

Even though charging is possible with the Start/Stop button in the ON/START position, for your safety, start charging when the Start/Stop button is in the OFF position and the vehicle shifted to P (Park). After charging has started, you can use electrical components such as the radio by pressing the Start/Stop button to the START or ON position.

During charging, the gear cannot be shifted from P (Park) to any other gear.

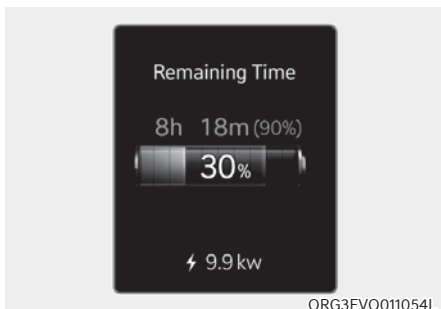

10. After charging has started, the estimated charging time is displayed on the instrument cluster for about 1 minute.

If you open the driver's door while charging, the estimated charging time is also displayed on the instrument cluster for about 1 minute. When scheduled charging or scheduled air conditioner/heater is set, the estimated charging time is displayed as "--".

### **i** Information

Depending on the condition and durability of the high voltage battery, charger specifications, and ambient temperature, the time required for charging the battery may vary.

### **Checking Charging Status**

When charging the high voltage battery, the charge level can be checked from outside the vehicle.



For more details, refer to 'Charge Indicator Lamp for Electric Vehicle' in this chapter.



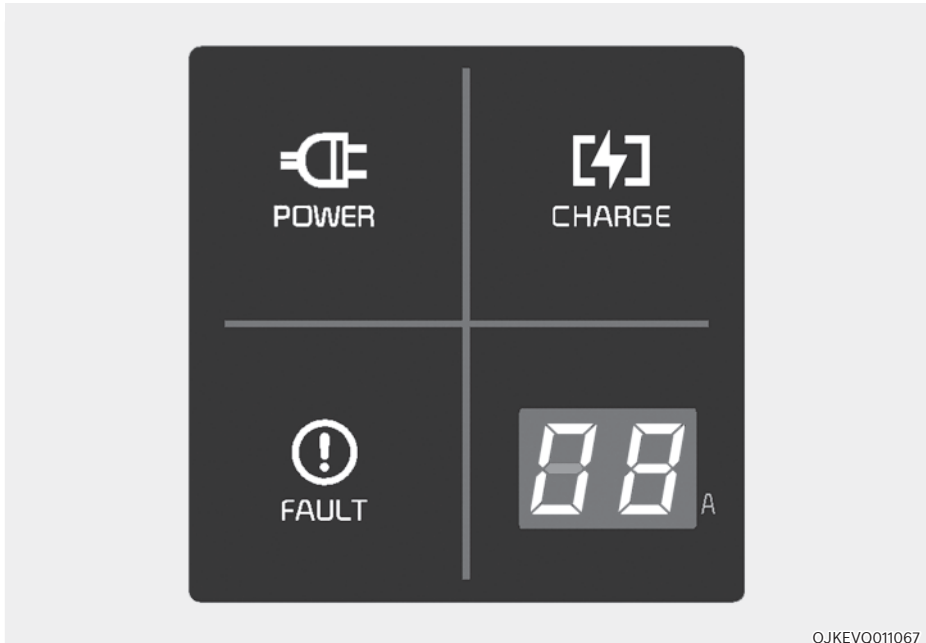



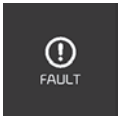

**Charging Status Indicator Lamp for Portable Charger**



OJKEVQ011067

Indicator		Details
POWER		On: Power on
CHARGE		On: Charge Blink: Current limit due to high plug temperature or high internal temperature
FAULT		Blink: Charging interrupted

Indicator		Details		
Error code		On: Error while charging/ Error during self-diagnosis		
		Error code	Item	Cause
		E1	Control Pilot communication	Vehicle communication error
		E2	Leakage	Current leakage
		E3		Charger error
		E4	Plug temperature	Plug overtemperature warning
		E5		Plug temperature failure
		E6		Charger error
		E7	Overcurrent	Charging overcurrent warning
		E8	Internal temperature	Charger overheating
		E9		Charger error
		F1	Relay fusion	Charger error
		F2	Ground Monitoring/ Interrupt	Poor grounding of outlet
		F3	Switched mode power supply power failure	Switched mode power supply error (voltage failure)
		F4		Switched mode power supply error (abnormal voltage)
		F5	Control Pilot voltage error	Control Pilot (-) voltage error
		F6		Control Pilot (+) voltage error
F7	Temperature sensor error	Plug temperature sensor error		
F8		PCB internal temperature sensor error		

Indicator	Details
	12 A
	10 A
	8 A
	6 A
CHARGE LEVEL	<p>The charging current changes whenever the button (1) is pressed for less than 1 sec with the charger plugged into an electrical outlet but not the vehicle.</p> <div style="display: flex; align-items: center;"> <div style="margin-right: 20px;"> <p>* The control box</p>  </div> <div style="text-align: right;"> <p>ORG3EVQ011075</p> </div> </div>

## Status / Diagnosis / Countermeasure

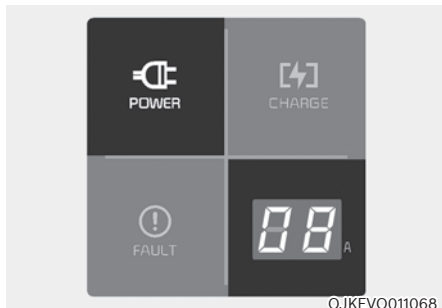

- Charging connector plugged into vehicle (POWER Green ON)
- Plug connected to an electric outlet (POWER Green ON)

We recommend that you contact an authorized retailer of Genesis Branded products.



### While charging

- Charge indicator (POWER Green ON / CHARGE Blue ON)
- Charging current

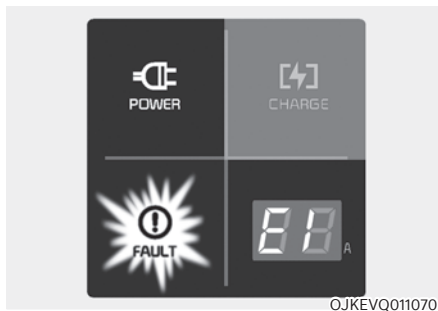

Before plugging charging connector into vehicle (POWER Green ON, FAULT Red blink)

- Abnormal temperature
- ICCB (In-Cable Control Box) failure

We recommend that you contact an authorized retailer of Genesis Branded products.

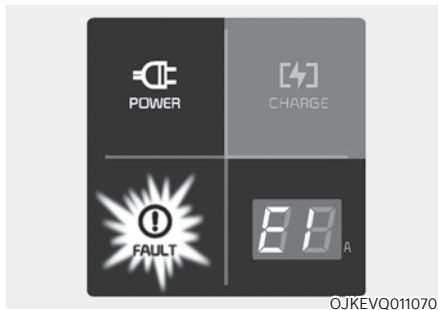

Plugged into vehicle (POWER Green ON, FAULT Red Blink)

- Diagnostic device failure
- Current leakage
- Abnormal temperature

We recommend that you contact an authorized retailer of Genesis Branded products.



OJKEVQ011071

- Leakage current failure (POWER Green ON, FAULT Red Blink)
- After disconnecting and reconnecting the power plug, press and release the button for 2 seconds or longer to clear the error.

We recommend that you contact an authorized retailer of Genesis Branded products.



OJKEVQ011072

#### Power saving mode

- 7-segment display is turned off if there is no status change for more than 1 minute.

### How to Disconnect Portable Charger (ICCB: In-Cable Control Box)

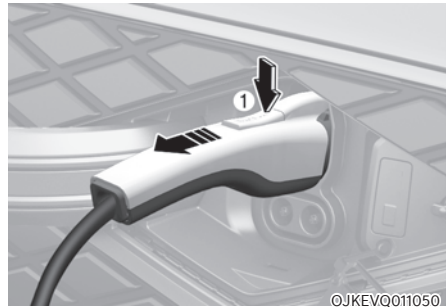

OJKEVQ011050

1. Press release button (1), then remove charging connector from the vehicle inlet.

### **i** Information

To prevent charging cable theft, the charging connector cannot be disconnected from the inlet when the doors are locked or the charging connector is in the 'Locking while charging' mode. Unlock all doors to disconnect the charging connector from the inlet.

However, if the vehicle is in the charging connector 'Always lock' mode, the charging connector automatically unlocks from the inlet when charging is completed.

If you attempt to disconnect the charging connector without pressing the release button, the connector and the inlet may be damaged.

For more details, refer to "Charging Connector 'Always lock'/'Locking while charging' Mode" in this chapter.

If the release button does not work even after the all doors are unlocked, pull the emergency lift cable in the motor room and press the release button in the connector to disconnect it from the vehicle. If the release button still does not work, we recommend to consult an authorized retailer of Genesis Branded products.

**i Information**

Some connectors installed in public charging stations stop charging by pressing the charge release button while charging is locked, and the connector can be disconnected.



2. Make sure to completely close the charging door.

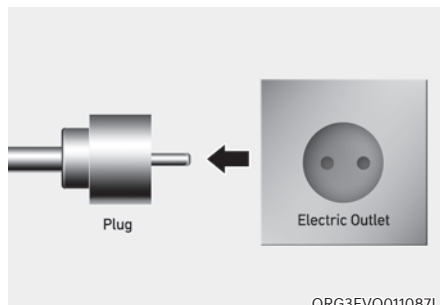

3. Disconnect the plug from the household electric outlet. Do not pull the cable when disconnecting the plug.
4. Close the protection caps of the charging connector and the charging plug to protect them from foreign substances.
5. If the personal charging connector is used, store the connector in the cable compartment.

***Precautions for Portable Charger (ICCB: In-Cable Control Box)***

- Use the portable charger that is certified by Genesis Branded Vehicle.
- Do not try to repair, disassemble, or adjust the portable charger.
- Do not use an extension cord or adapter.
- Stop using immediately when failure occurs.
- Do not touch the plug and charging connector with wet hands.
- Do not touch the terminal part of the AC charging connector and the AC charging inlet on the vehicle.
- Do not connect the charging connector to voltage that does not comply with regulations.
- Do not use the portable charger if it is worn out, exposed, or there exists any type of damage on the portable charger.
- If the ICCB case and AC charging connector is damaged, cracked, or the wires are exposed in any way, do not use the portable charger.
- Do not let children operate or touch the portable charger.
- Keep the control box free of water.
- Keep the normal charging connector or plug terminal free of foreign substances.
- Do not step on the cable or cord. Do not pull the cable or cord and do not twist or bend it.
- Do not charge when there is lightning.
- Do not drop the control box or place a heavy object on the control box.
- Do not place an object that can generate high temperatures near the charger when charging.
- Charging with the worn out or damaged household electric outlet can result in a risk of electric shock. If you have doubts about the condition of a household electric outlet, have it checked by a licensed electrician.
- Stop using the portable charger immediately if the household electric outlet or any components is overheated or you notice burnt odors.

## CHARGING THE ELECTRIC VEHICLE (ABRUPT STOP)

### Action to be taken when charging stops abruptly

When the high voltage battery does not charge, check the followings:

1. Check the charging setting for the vehicle. Refer to “Charge Management”, in this chapter (for example, If target battery charge level is lower than high voltage battery charge level or when scheduled charging is set, charging is not initiated immediately when the AC charger or portable charger (ICCB: In-Cable Control Box) is connected.)
2. Check the operation status of AC charger, portable charger and DC charger. (Charging Status Indicator Lamp for Portable Charger, refer to “Checking Charging Status” for trickle charge in this chapter.)
  - \* Actual method for indicating the charging status may vary in accordance with the charger manufacturer.
3. When the vehicle does not charge and a warning message appears on the cluster, check the corresponding message. Refer to “LCD Display Messages”, in this chapter.
4. If the vehicle is properly charged when charged with another normally working charger, contact the charger manufacturer.
5. If the vehicle does not charge when charged with another normally working charger, we recommend that you contact an authorized retailer of Genesis Branded products for inspection.
6. If charging fails and the service warning light (⚠️) is lit in the cluster, we recommend that you contact an authorized retailer of Genesis Branded products.



## DRIVING ELECTRIC VEHICLE

### How to start the vehicle

1. Holding the smart key, sit in the driver's seat.
2. Fasten the seat belt before starting the vehicle.
3. Make sure to engage the parking brake.
4. Turn OFF all electrical devices.
5. Depress and hold the brake pedal while pressing the Start/Stop button.

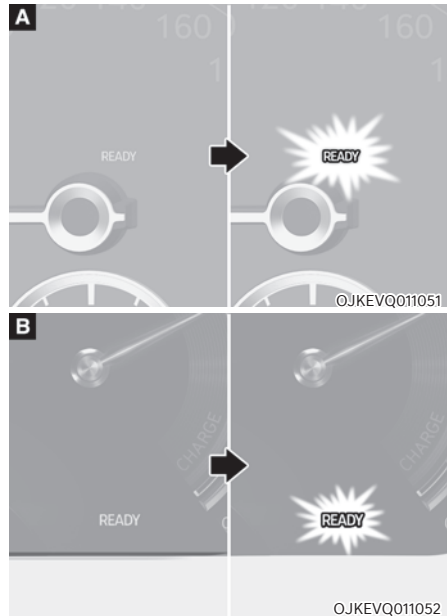

6. When the ready (**READY**) indicator is ON, you can drive the vehicle.  
When the ready (**READY**) indicator is OFF, you cannot drive the vehicle. Start the vehicle again.
7. Depress and hold the brake pedal and shift to the desired gear position.

### **i** Information

**While the charging cable is connected, the gear cannot be shift from P (Park) to any other gear for safety reasons.**

8. Release the parking brake and slowly release the brake pedal. Check if the vehicle slowly moves forward, then depress the accelerator pedal.

## How to shut off the vehicle

1. Hold down the brake pedal while the vehicle is stopped.
2. While depressing the brake pedal, shift to P (Park).
3. While depressing the brake pedal, engage the parking brake.
4. While depressing the brake pedal, press the Start/Stop button and turn off the vehicle.

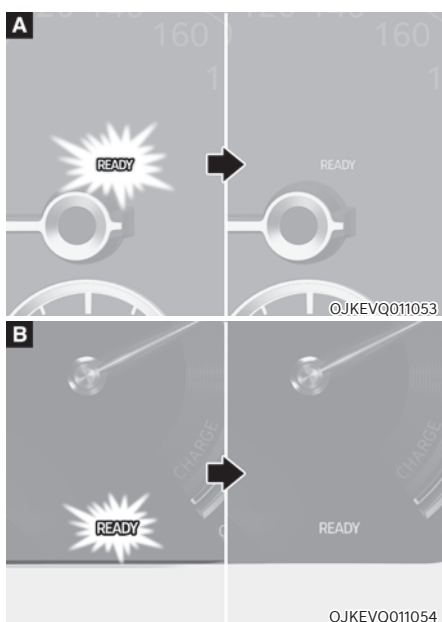

5. Check if the ready (**READY**) indicator is turned OFF on the instrument cluster.

When the ready (**READY**) indicator is ON and the gear is in a position other than P (Park), the driver can accidentally depress the accelerator pedal, causing the vehicle to move unexpectedly.

## Virtual engine sound system

The Virtual Engine Sound System (V ESS) generates sound for pedestrians to hear because there is no sound while the Electric Vehicle (EV) is operating.

- If the vehicle is in the ready (**READY**) mode and any gear other than P (Park) is selected, the V ESS will be operated.
- When the gear is shifted to R (Reverse), an additional warning sound will be heard.

### CAUTION

- **The vehicle is much quieter while driving than a conventional gasoline-powered vehicle. Be aware of your surroundings and always drive safely.**
- **After you park the vehicle or while you are waiting at a traffic light, check whether there are children or obstacles around the vehicle.**
- **Check if there is something behind the vehicle when driving in reverse. Pedestrians may not hear the sound of the vehicle.**

## Distance to empty



The distance to empty range displayed will vary depending upon which drive mode is selected in Drive Mode Integrated Control System.

For more information, refer to “Drive Mode Integrated Control System” in chapter 6.

### *When destination is not set*

- On average, a vehicle can drive about 455 km (283 miles).
- Under certain circumstances where the air conditioner/heater is ON, the distance to empty is impacted, resulting in a possible distance range from 300 km (186 miles). When using the heater during cold weather or driving at high speed, the high voltage battery consumes a lot more electricity. This may reduce the distance to empty significantly.
- After '0 km' has been displayed, the vehicle may stop soon. Immediately drive to a safe place and stop your vehicle.

- Distance to empty that is displayed on the instrument cluster after completing a recharge may vary significantly depending on previous operating patterns.

When previous driving patterns include high speed driving, resulting in the high voltage battery using more electricity than usual, the estimated distance to empty is reduced. When the high voltage battery uses little electricity in ECO mode, the estimated distance to empty increases.

- Distance to empty may depend on many factors such as the charge amount of the high voltage battery, weather, temperature, durability of the battery, geographical features, and driving style. When the ambient temperature is low such as in winter, the actual driving distance may reduce due to degradation of the battery.
- Natural degradation may occur with the high voltage battery depending on the number of years the vehicle is used. This may reduce the distance to empty.

### ***When destination is set***

When the destination is set, the distance to empty may change. The distance to empty is recalculated using the information of the destination. However, the distance to empty may vary significantly based on traffic conditions, driving habits, and condition of the vehicle.

### **Tips for improving distance to empty**

- If you operate the air conditioner / heater too much, the driving battery uses too much electricity. This may reduce the distance to empty. Therefore, it is recommended that you set the cabin temperature to 22°C AUTO. This setting that has been certified by various assessment tests to maintain optimal energy consumption rates while keeping the temperature fresh.  
Turn OFF the heater and air conditioner if you do not need them.
- When the heater or air conditioning system is on the energy consumption is reduced if recirculation mode is selected instead of selecting the fresh mode. The fresh mode requires large amount of energy consumption as the outside air has to be re-heated or cooled.
- When using the heater or air conditioning system use the DRIVER ONLY or scheduled air conditioner/ heater function.
- Depress and hold the accelerator pedal to maintain speed and drive economically.
- Gradually depress and release the accelerator pedal when accelerating or decelerating.
- Always maintain specified tire pressures.
- Do not use unnecessary electrical components while driving.
- Do not load unnecessary items in the vehicle.
- Do not mount parts that may increase air resistance.

### Electric energy economy history

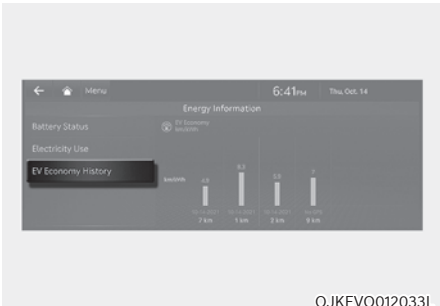

It is possible to check the history of electric energy economy with the date and distance of previous driving. The icon is displayed on the most efficient electric energy economy record.

### Energy information

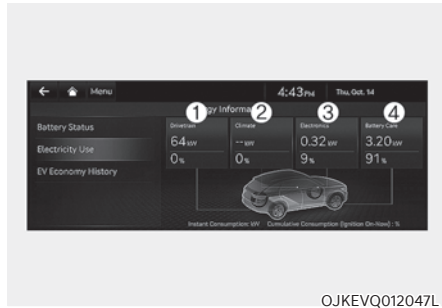

In order to check the current energy consumption for each system of the vehicle, select 'EV → Energy information' on the screen.

1. 'Driving' shows the total power and energy consumption of the driving motor's driving energy and regenerative energy.
2. 'Climate' shows the power and energy consumption which are used by the heater or air conditioner.
3. 'Electronics' shows the power and energy consumption which are used by the vehicle systems including the cluster, infotainment system (speaker and navigation), headlamp, vehicle control unit, etc.
4. 'Battery care' shows the momentary power and energy consumption which are used when:
  - Operating the battery conditioning mode to increase the battery temperature during winter to improve the driving performance.
  - Cooling down the battery temperature during summer to prevent over temperature of the battery.

## Power/Charge Gauge

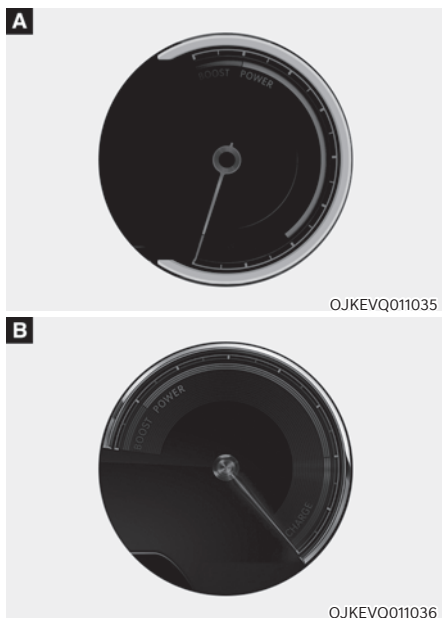

The Power/Charge Gauge shows the energy consumption and recovery status of the electric motor.

- **POWER:**  
It shows discharging status of the electric motor when vehicle is accelerating or driving on an uphill road. The more electric energy is discharged (used), the higher the gauge level.
- **CHARGE:**  
It shows the charging status of the electric motor when vehicle is decelerating or driving on a downhill road (being charged by the regenerative brakes). The more electric energy is charged, the lower the gauge level.

## State of charge (SOC) gauge for high voltage battery

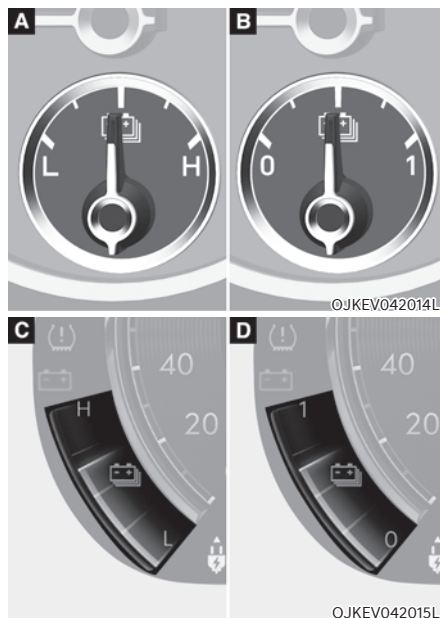

- The SOC gauge shows the charging status of the high voltage battery.
- The 'L' or '0' on the indicator indicates that there is not enough energy in the high voltage battery. 'H' or '1' indicates that the driving battery is fully charged.
- When driving on highways or motorways, make sure to check in advance if the driving battery is charged enough.



1. When the remaining battery is lower than 10 % on the SOC gauge, the warning light (🔋⚡) turns ON to alert you of the battery level.
2. When the warning light (🔋⚡) turns ON, the vehicle can drive an additional 20~40 km (12~25 miles) depending on the driving speed, heater/air conditioner, weather, driving style, and other factors. Charging is required.

**NOTICE**

**When the high voltage battery level is low, the power down indicator light illuminates and the vehicle power is limited. Charge the battery immediately since your vehicle may not be driven, or may roll back on a slope with the indicator light ON.**

**Warning and Indicator lights (related to electric vehicle)**

**Ready indicator**

**READY**

**This indicator illuminates:**

When the vehicle is ready to be driven.

- ON : Normal driving is possible.
- OFF : Normal driving is not possible, or a problem has occurred.
- Blinking : Emergency driving.

When the ready indicator goes OFF or blinks, there is a problem with the system. In this case, we recommend that you have your vehicle inspected by an authorized retailer of Genesis Branded products.

**Service Warning Light**



**This warning light illuminates:**

- When the Start/Stop button is in the ON position.
  - It illuminates for approximately 3 seconds and then goes off.
- When there is a problem with related parts of the electric vehicle control system, such as sensors, etc.

When the warning light illuminates while driving, or does not go OFF after starting the vehicle, we recommend that you have your vehicle inspected by an authorized retailer of Genesis Branded products.

**Power Down Indicator Light****This indicator light illuminates:**

When the power is limited for the safety of the high-powered parts of an electric vehicle. The power is limited for the following reasons. (Unless both Service Warning Light and Power Down Indicator Light illuminate at the same time, it is not a failure.)

- The high voltage battery level is too low or voltage is decreasing
- The temperature of the high voltage battery is too high or too low
- The temperature of the motor is high

**NOTICE**

- **Do not accelerate or start the vehicle suddenly when the power down warning light is ON.**
- **When the power is limited for the safety of the high-powered components of an electric vehicle, the power down indicator light illuminates. Your vehicle may not be driven, or may roll back on a slope with the indicator light ON due to the limitation of the vehicle power.**

**Charging Indicator Light****This warning light illuminates:**

- When the charging cable is connected.

**High Voltage Battery Level Warning Light****This warning light illuminates:**

- When the high voltage battery level is low.
- When the warning light turns ON, charge the battery immediately.

**Regenerative Brake Warning Light****This warning light illuminates:**

When the regenerative brake does not operate and the brake does not perform well. This causes the Brake Warning light (red) and Regenerative Brake Warning Light (yellow) to illuminate simultaneously.

In this case, drive safely and we recommend that you have your vehicle inspected by an authorized retailer of Genesis Branded products.

The operation of the brake pedal may be more difficult than normal and the braking distance can increase.



### LCD display messages

#### Shift to P to charge

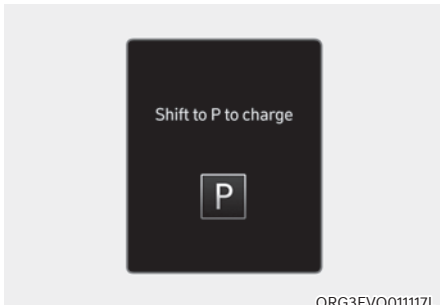

This message is displayed if you connect the charging cable without the gear in the P (Park) position.

Shift to P (Park) before connecting the charging cable.

#### Remaining time

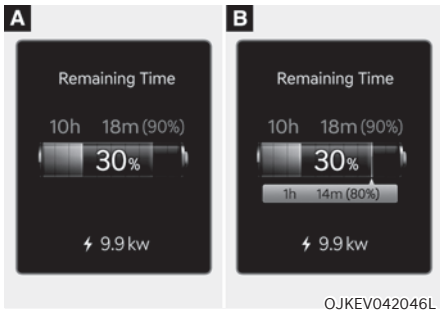

[A]: AC charge, [B]: DC charge

This message displays how much time remains until the battery is charged to the selected target battery charge level.

#### Unplug vehicle to start



This message is displayed when you start the vehicle without unplugging the charging cable. Unplug the charging cable, and then turn on the vehicle.

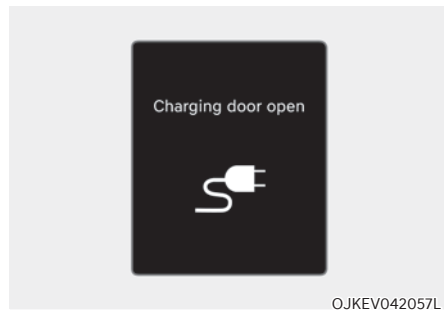

This message is displayed when the vehicle is driven with the charging door opened. Close the charging door and then start driving.

***Charging Stopped. Check the charger/Charging interrupted. Check the charger***

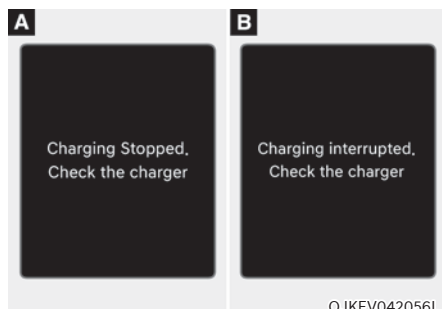

- This warning message is displayed when charging is stopped for the reasons below:
  - There is a problem with the external AC charger or DC charger
  - The external AC charger stopped charging
  - The charging cable is damaged

In this case, check whether there is any problem with the external AC or DC charger and charging cable.

If the same problem occurs when charging the vehicle with a normally operating AC charger or genuine Genesis portable charger, we recommend that you have your vehicle inspected by an authorized retailer of Genesis Branded products.

***Charging Stopped. Check the cable connection/Charging interrupted. Please check the cable connection***

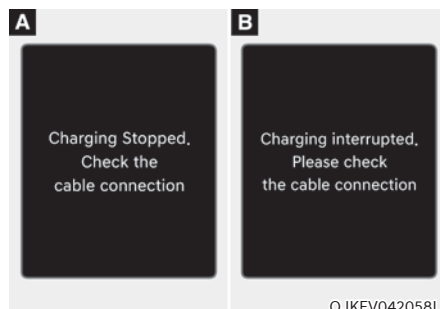

This warning message is displayed when charging is stopped because the charging connector is not correctly connected to the charging inlet.

In this case, separate the charging connector and re-connect it and check whether there is any problem (external damage, foreign substances, etc.) with the charging connector and charging inlet.

If the same problem occurs when charging the vehicle with a replaced charging cable or genuine Genesis portable charger, we recommend that you have your vehicle inspected by an authorized retailer of Genesis Branded products.

### Check regenerative brakes

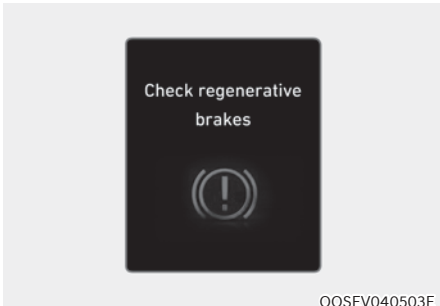

This warning message is displayed when the regenerative brake system does not work properly.

In this case, we recommend that you have the vehicle inspected by an authorized retailer of Genesis Branded products.

### Low EV battery/Low battery

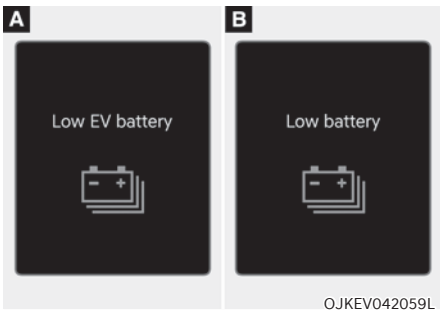

When the high voltage battery level reaches below approximately 10%, this warning message is displayed.

The warning light on the instrument cluster (⚡) will turn ON simultaneously. Charge the high voltage battery immediately.

### Charge immediately. Power limited

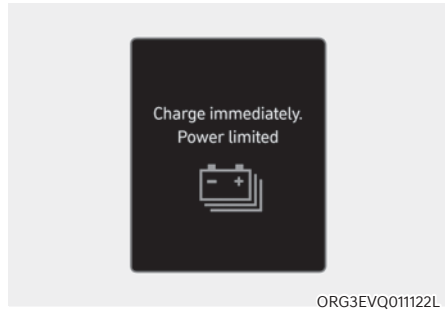

When the high voltage battery level reaches below approximately 5%, this warning message is displayed.

The warning light on the instrument cluster (⚡) will turn on simultaneously.

The vehicle's power will be reduced to minimize the energy consumption of the high voltage battery. Charge the battery immediately.

***Power limited due to low EV batter temperature. Charge battery***

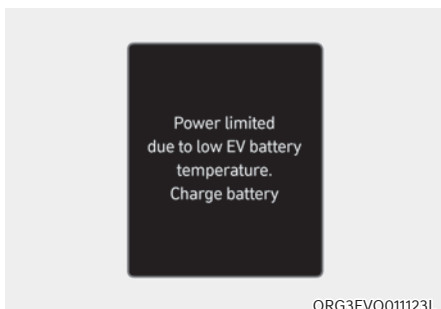

ORG3EVQ011123L

Both warning messages are displayed to protect electric vehicle system when outside temperature is low. If the high voltage battery charging level is low and parked outside in low temperature for a long time, vehicle power could be limited.

Charging the battery before driving helps increase power.

**NOTICE**

**If these warning messages still display even after the ambient temperature has increased, we recommend that you have the vehicle inspected by an authorized retailer of Genesis Branded products.**

***EV Battery Overheated! Stop vehicle/Battery overheated! Stop safely***

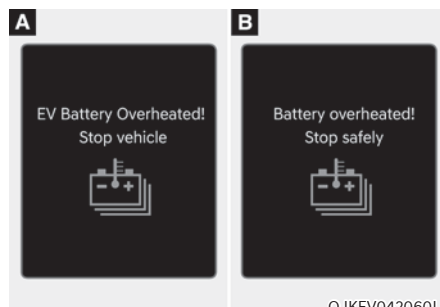

OJKEV042060L

This warning message is displayed to protect battery and electric vehicle system when the high voltage battery temperature is too high.

Turn off the Start/Stop button and stop the vehicle so that the battery temperature decreases

### Power limited



This warning message is displayed:

- To ensure the safety of high-powered components of electric vehicles, the power is limited for the following reasons. (Unless both Service Warning Light and Power Down Indicator Light illuminate at the same time, it is not a failure.)
  - The high voltage battery level is too low or voltage is decreasing
  - The temperature of the high voltage battery is too high or too low
  - The temperature of the motor is high

### NOTICE

- **When this warning message is displayed, do not accelerate or start the vehicle suddenly.**
- **When the power is limited for the safety of the high-powered parts of the electric vehicle, the warning message is displayed. Your vehicle may not be driven, or may roll back on a slope with the warning message displayed due to the limitation of vehicle power.**

### Stop vehicle and check power supply/Stop safely and check power supply

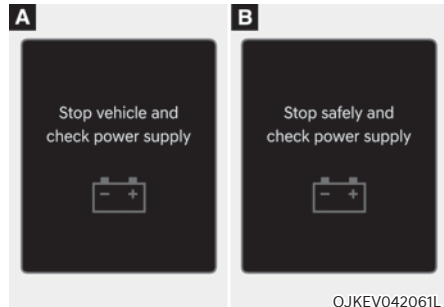

This warning message is displayed when a failure occurs in the power supply system.

In this case, park the vehicle in a safe location and we recommend that you have your vehicle towed to the nearest authorized retailer of Genesis Branded products and have the vehicle inspected.

### Check electric vehicle system



This warning message is displayed when there is a problem with the electric vehicle control system.

Refrain from driving when the warning message is displayed.

In this case, we recommend that you have the vehicle inspected by an authorized retailer of Genesis Branded products.

## Aux. Battery Saver+

The Aux. Battery Saver+ is a function that monitors the charging status of the 12 V auxiliary battery. If the auxiliary battery level is low, the main high voltage battery charges the auxiliary battery.



### Information

- **The Aux. Battery Saver+ function cannot prevent battery discharge if the auxiliary battery is damaged, worn out, used as a power supply or unauthorized electronic devices are used.**
- **If the Aux. Battery Saver+ function was activated, the high voltage battery level may have decreased.**



### WARNING

**When this function is activating the indicator lamp will illuminate and high voltage electricity will be flowing into the vehicle. Do not touch the high voltage electric wire, connector, or any electrical components and devices. This may cause an electric shock and lead to injuries. Also, do not modify your vehicle in any way. This may affect your vehicle performance and lead to an accident.**

## SAFETY PRECAUTIONS FOR ELECTRIC VEHICLE

### If an accident occurs

#### WARNING

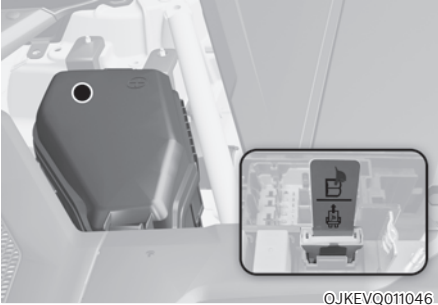

- When a vehicle accident occurs, move the vehicle to a safe place, turn OFF the vehicle and disconnect the high voltage cut-off switch from the auxiliary battery (12 V) to prevent high voltage electricity from flowing.
- If electric wires are exposed from inside or outside the vehicle, do not touch the wires.

Also, do not touch the high voltage electric wire (orange), connector, and all electric components and devices. This may cause electric shock and lead to injuries.

#### WARNING

- When a vehicle accident occurs and the high voltage battery is damaged, harmful gas and electrolytes may leak. Be careful not to touch the leaked liquid.
- When you suspect leakage of inflammable gas and other harmful gases, open the windows and evacuate to a safe location. If any leaked fluid comes in contact with your eyes or skin, immediately clean the affected area thoroughly with tap water or saline solution and have doctors inspect it as soon as possible.

#### WARNING

- If a small scale fire occurs, use a fire extinguisher (ABC, BC) that is meant for electrical fires. If it is impossible to extinguish the fire in the early stage, maintain a safe distance from the vehicle and immediately call your local fire emergency responders. Also, advise them that an electric vehicle is involved.
- If the fire spreads to the high voltage battery, large amount of water is needed to put out the fire. Using small amount of water or fire extinguishers not meant for electrical fires could cause serious injury or death from electrical shocks.

#### WARNING

If you cannot put out the fire immediately, the high voltage battery may explode. Evacuate to a safe place and do not let other people approach the site.

Contact the fire department and notify them of an electric vehicle fire.

- If the vehicle is flooded with water, immediately turn off the vehicle and evacuate to a safe place. We recommend to contact the fire department or an authorized retailer of Genesis Branded products.

 **WARNING**

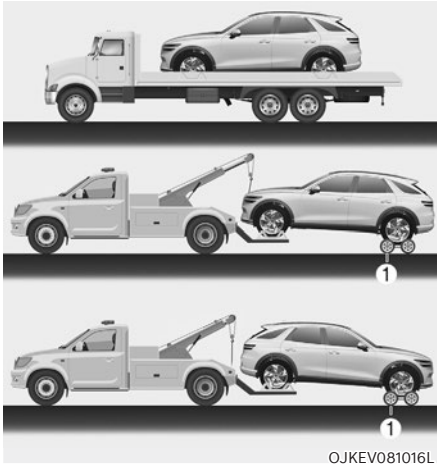

[1]: Dollies

- For AWD vehicles, it must be towed with a wheel lift and dollies or flatbed equipment with all the wheels off the ground.

 **WARNING**

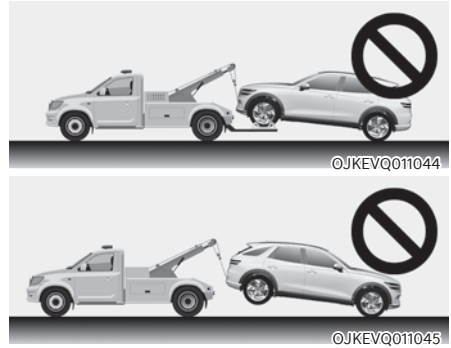

- If you tow the vehicle while the 2WD: rear, AWD: front/rear wheels are touching the ground, the vehicle motor may generate electricity and the motor components may be damaged or a fire may occur.
- When a vehicle fire occurs due to the battery, there is a risk of a second fire. Contact the fire department when towing the vehicle.



### Other precautions for electric vehicle

- When you paint or apply heat treatment to the vehicle as a result of an accident, the performance of the high voltage battery can be reduced.
- If heat treatment is required, we recommend that you contact an authorized retailer of Genesis Branded products.
- When you clean the motor compartment, do not use high pressure water to wash. This may cause an electric shock due to a discharge in high voltage electricity, or damage the vehicle's electric system.
- We recommend that you use or install genuine Genesis part or the equivalent (of the genuine part) specified for your vehicle.

### High voltage cut-off switch

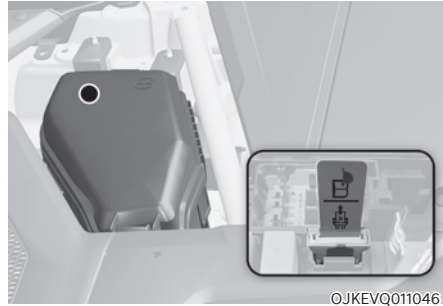

Pull down the yellow lever in the high voltage cut-off switch to shut down high voltage battery.



#### **WARNING**

**Never disconnect the high voltage cut-off switch except in an emergency situation.**

**Serious problems may occur, such as the vehicle will not start.**

#### **NOTICE**

**Putting excessive force to the switch lever while shutting down the high voltage battery may severely damage the high voltage cut-off switch.**

# 2. Vehicle information

Exterior overview (I).....	2-2
Exterior overview (II).....	2-3
Interior overview (I) .....	2-4
Interior overview (II) .....	2-5
Instrument panel overview (I).....	2-6
Instrument panel overview (II).....	2-7
Instrument panel overview (III).....	2-8
Motor compartment .....	2-9
Dimensions.....	2-10
Electric vehicle specifications .....	2-10
Bulb wattage .....	2-11
Tires and wheels .....	2-12
Load and speed capacity tires (for europe) .....	2-13
Air conditioning system.....	2-13
Vehicle weight and luggage volume .....	2-13
Recommended lubricants and capacities .....	2-14
Vehicle Identification Number (VIN) .....	2-15
Vehicle certification label.....	2-15
Tire specification and pressure label.....	2-16
Motor number .....	2-16
Air conditioner compressor label .....	2-17
Refrigerant label .....	2-17
Declaration of conformity .....	2-18
Open Source Software Notice .....	2-18

## EXTERIOR OVERVIEW (I)



- |                                  |      |  |      |
|----------------------------------|------|--|------|
| 1. Hood.....                     | 5-48 | 5. Panorama sunroof .....              | 5-44 |
| 2. Headlamp.....                 | 9-48 | 6. Front windshield wiper blades ..... | 9-17 |
| 3. Tires and wheels.....         | 9-24 | 7. Windows .....                       | 5-39 |
| 4. Outside rearview mirror ..... | 5-35 | 8. Front radar .....                   | 7-4  |

## EXTERIOR OVERVIEW (II)

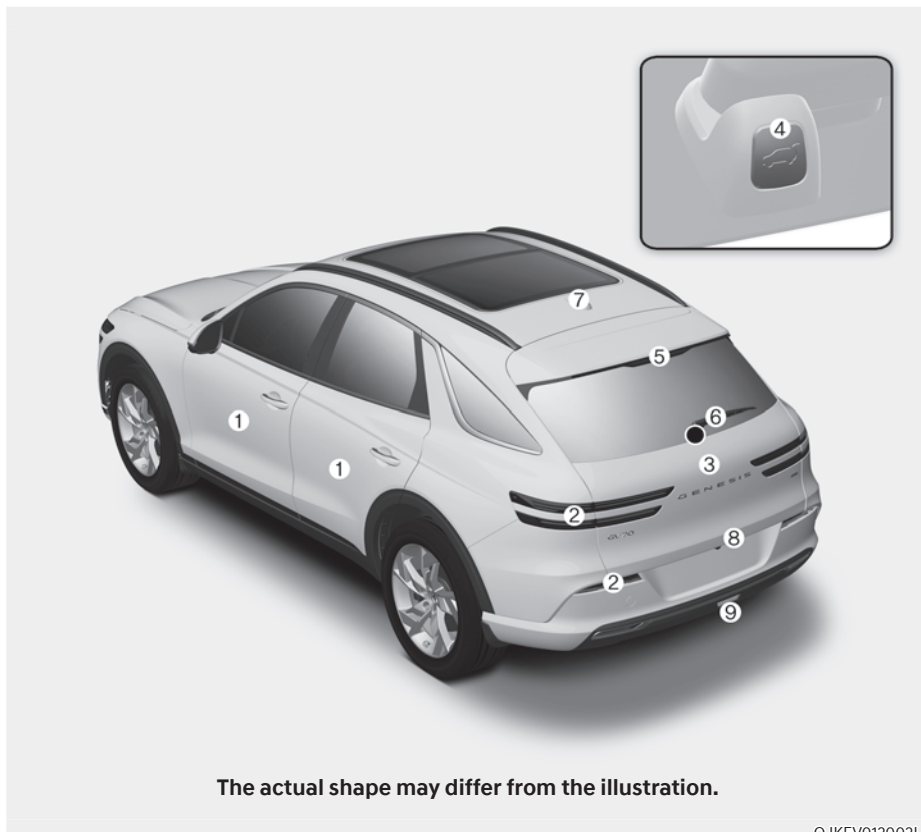

OJKEV012002L

- |                                    |      |                                   |       |
|------------------------------------|------|-----------------------------------|-------|
| 1. Door.....                       | 5-15 | 6. Rear window wiper blades ..... | 9-19  |
| 2. Rear combination lamp.....      | 9-51 | 7. Antenna .....                  | 5-122 |
| 3. Tailgate .....                  | 5-51 | 8. Rear view camera .....         | 7-121 |
| 4. Tailgate open/close button..... | 5-53 | 9. Rear fog lamp .....            | 9-51  |
| 5. High mounted stop lamp.....     | 9-52 |                                   |       |

## INTERIOR OVERVIEW (I)

■ Left-hand drive

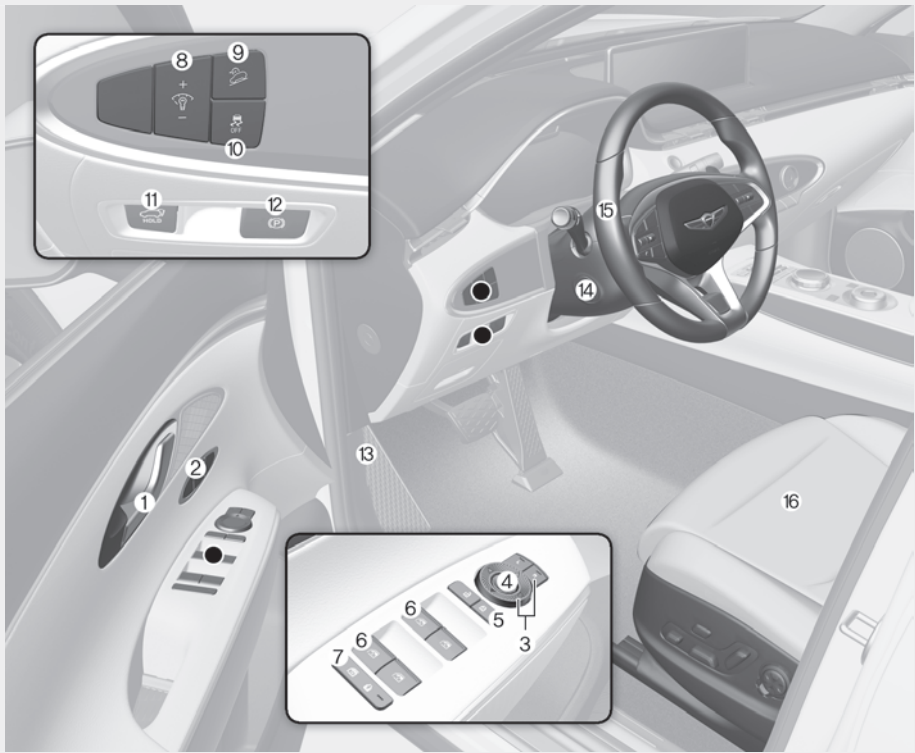

The actual shape may differ from the illustration.

OJKEV011003

- |  |      |  |      |
|--|------|--|------|
| 1. Inside door handle.....                           | 5-16 | 9. DBC (Downhill Brake Control) button.....            | 6-47 |
| 2. Integrated memory system .....                    | 5-26 | 10. ESC (Electronic Stability Control) OFF button..... | 6-40 |
| 3. Outside rearview mirror control switch .....      | 5-36 | 11. Power tailgate open/close button.....              | 5-53 |
| 4. Outside rearview mirror folding button .....      | 5-36 | 12. EPB (Electronic Parking Brake) switch .....        | 6-31 |
| 5. Central door lock switch .....                    | 5-17 | 13. Hood release lever.....                            | 5-48 |
| 6. Power window switches .....                       | 5-39 | 14. Steering wheel tilt/telescopic switch..            | 5-30 |
| 7. Power window lock button/ .....                   | 5-42 | 15. Steering wheel .....                               | 5-29 |
| Electronic child safety lock button.....             | 5-20 | 16. Seat.....  | 3-4  |
| 8. Instrument panel illumination control switch..... | 4-5  |  |      |

## INTERIOR OVERVIEW (II)

■ Right-hand drive

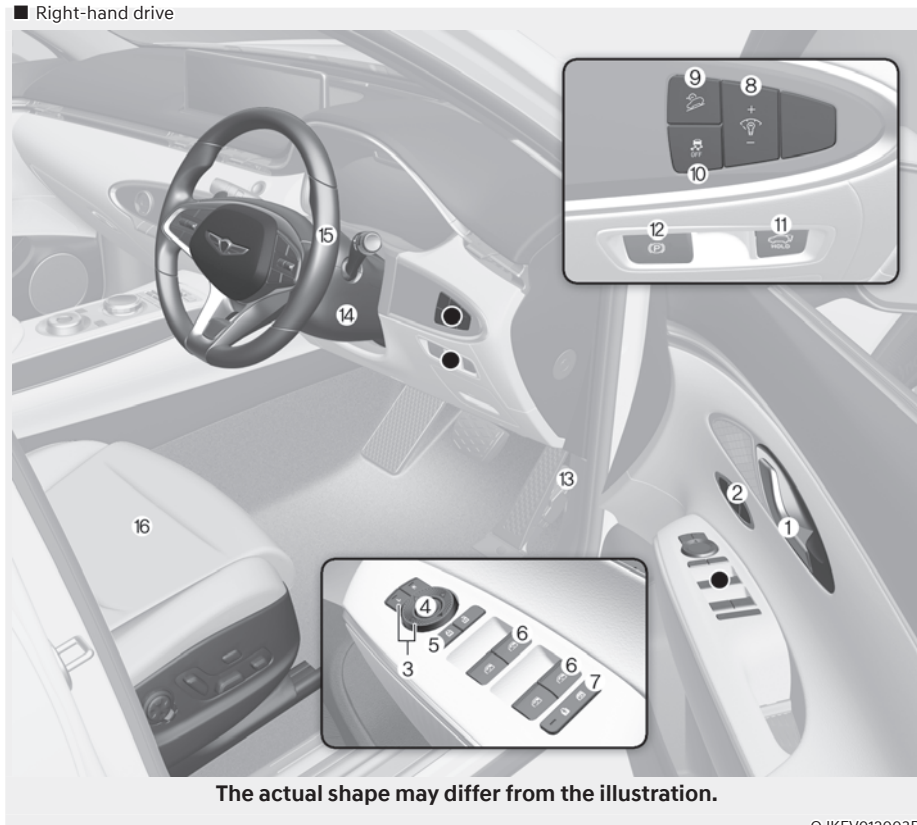

The actual shape may differ from the illustration.

OJKEV012003R

- |   |      |  |      |
|---|------|--|------|
| 1. Inside door handle.....                            | 5-16 | 9. DBC (Downhill Brake Control) button.....            | 6-47 |
| 2. Integrated memory system .....                     | 5-26 | 10. ESC (Electronic Stability Control) OFF button..... | 6-40 |
| 3. Outside rearview mirror control switch .....       | 5-36 | 11. Power tailgate open/close button.....              | 5-53 |
| 4. Outside rearview mirror folding button .....       | 5-36 | 12. EPB (Electronic Parking Brake) switch .....        | 6-31 |
| 5. Central door lock switch .....                     | 5-17 | 13. Hood release lever.....                            | 5-48 |
| 6. Power window switches .....                        | 5-39 | 14. Steering wheel tilt/telescopic switch..            | 5-30 |
| 7. Power window lock button/ .....                    | 5-42 | 15. Steering wheel.....                                | 5-29 |
| Electronic child safety lock button.....              | 5-20 | 16. Seat.....  | 3-4  |
| 8. Instrument panel illumination control switch ..... | 4-5  |  |      |

## INSTRUMENT PANEL OVERVIEW (I)

■ Left-hand drive

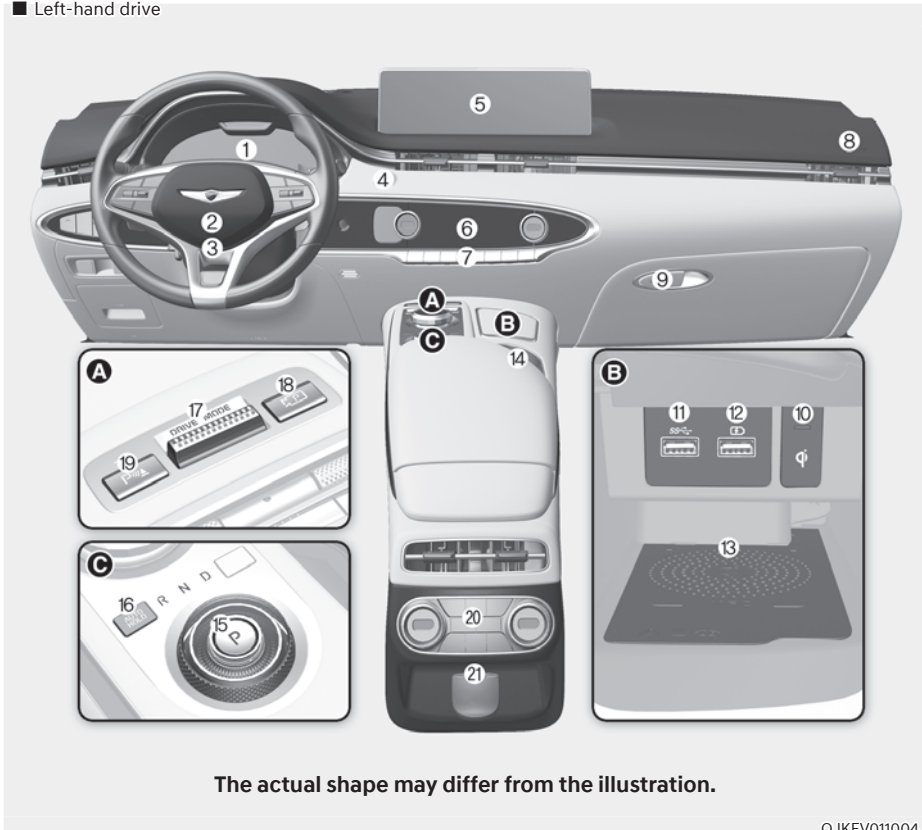

The actual shape may differ from the illustration.

OJKEV011004

- |  |   |
|--|---|
| 1. Instrument cluster ..... 4-4                  | 13. Wireless charging system pad.....5-114          |
| 2. Horn..... 5-31                                | 14. Cup holder ..... 5-110                          |
| 3. Driver's front air bag..... 3-54              | 15. Rotary shifter (Rotary gear shift dial)...6-10  |
| 4. Start/Stop button ..... 6-5                   | 16. Auto Hold button..... 6-35                      |
| 5. Infotainment system ..... 4-40, 5-122         | 17. Drive mode button/Terrain mode button..... 6-59 |
| 6. Automatic climate control ..... 5-84          | 18. Parking/View button ..... 7-123                 |
| 7. Hazard warning flasher button..... 8-2        | 19. Parking Safety button..... 7-144                |
| 8. Passenger's front air bag ..... 3-54          | 20. Rear seat climate control..... 5-85             |
| 9. Glove box .....5-108                          | 21. USB charger (Rear seat).....5-113               |
| 10. Wireless charging system indicator ....5-114 |   |
| 11. USB port..... 5-122                          |   |
| 12. USB charger .....5-113                       |   |

## INSTRUMENT PANEL OVERVIEW (II)

■ Right-hand drive

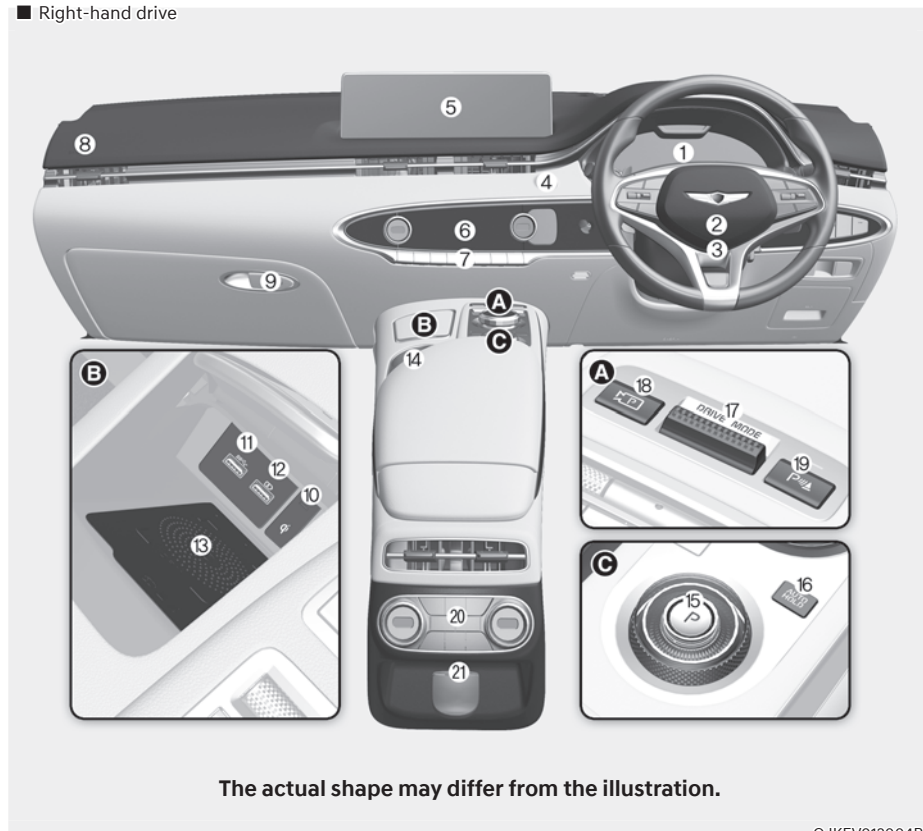

OJKEV012004R

- |   |             |   |       |
|---|-------------|---|-------|
| 1. Instrument cluster .....                 | 4-4         | 13. Wireless charging system pad.....             | 5-114 |
| 2. Horn.....                                | 5-31        | 14. Cup holder .....                              | 5-110 |
| 3. Driver's front air bag.....              | 3-54        | 15. Rotary shifter (Rotary gear shift dial)...    | 6-10  |
| 4. Start/Stop button .....                  | 6-5         | 16. Auto Hold button.....                         | 6-35  |
| 5. Infotainment system .....                | 4-40, 5-122 | 17. Drive mode button/Terrain mode<br>button..... | 6-59  |
| 6. Automatic climate control system .....   | 5-84        | 18. Parking/View button .....                     | 7-123 |
| 7. Hazard warning flasher button.....       | 8-2         | 19. Parking Safety button.....                    | 7-144 |
| 8. Passenger's front air bag .....          | 3-54        | 20. Rear seat climate control.....                | 5-85  |
| 9. Glove box .....                          | 5-108       | 21. USB charger (Rear seat).....                  | 5-113 |
| 10. Wireless charging system indicator .... | 5-114       |   |       |
| 11. USB port.....                           | 5-122       |   |       |
| 12. USB charger .....                       | 5-113       |   |       |



### INSTRUMENT PANEL OVERVIEW (III)

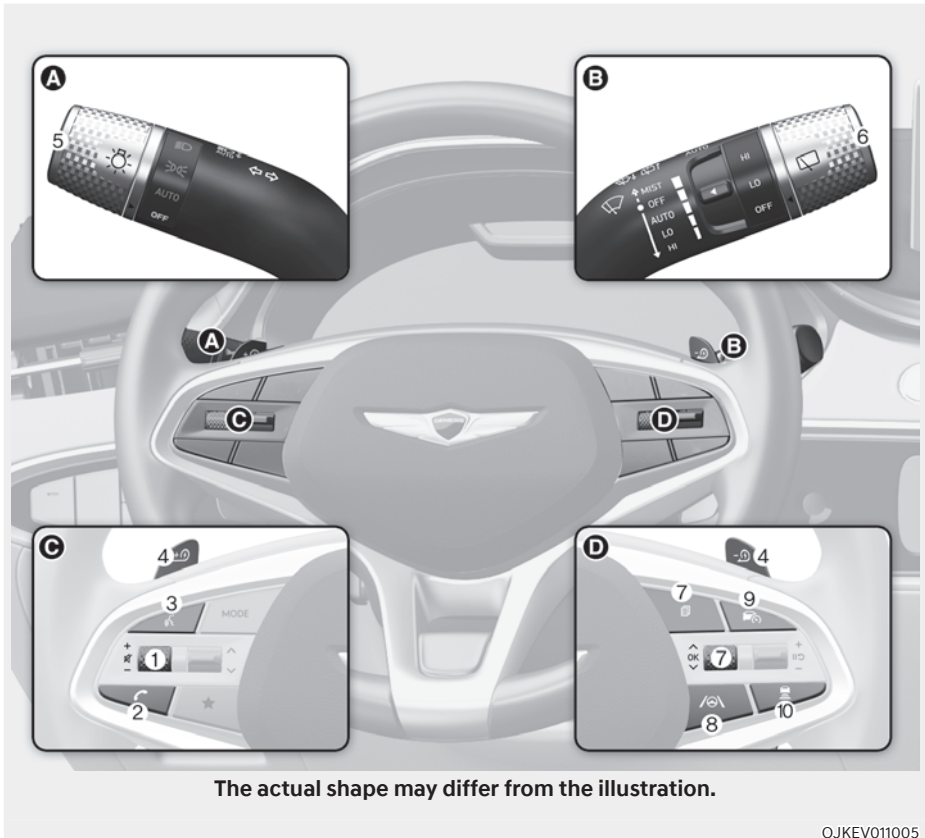

- 1. Audio remote control buttons ..... 5-122
- 2. Bluetooth® hands-free phone button.....5-124
- 3. Voice recognition button ..... 5-123
- 4. Regenerative Braking Paddles.....6-18
- 5. Lighting control lever ..... 5-64
- 6. Wiper and washer control lever.....5-80
- 7. LCD display control ..... 4-30
- 8. Lane Driving Assist button.....7-28
- 9. Driving Assist button ..... 7-57
- 10. Vehicle Distance button..... 7-83

## MOTOR COMPARTMENT

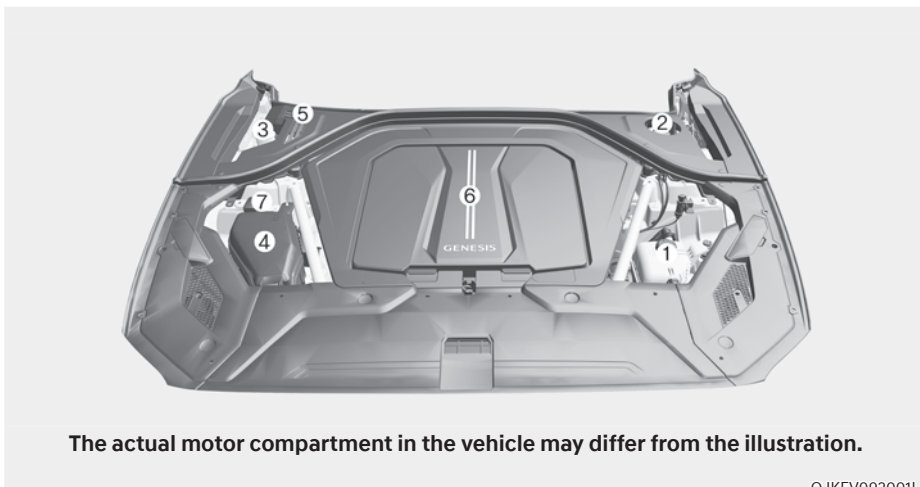

The actual motor compartment in the vehicle may differ from the illustration.

OJKEV092001L

- |  |      |                                  |      |
|--|------|----------------------------------|------|
| 1. Coolant reservoir .....                 | 9-12 | 5. Cabin air filter .....        | 9-15 |
| 2. Brake fluid reservoir .....             | 9-13 | 6. Front trunk .....             | 5-49 |
| 3. Windshield washer fluid reservoir ..... | 9-14 | 7. Jump-start negative (chassis) |      |
| 4. Fuse box .....                          | 9-33 | terminal .....                   | 8-5  |

## DIMENSIONS

Items		mm (in)	
Overall length		4,715 (185.6)	
Overall width		1,910 (75.2)	
Overall height		1,625 (64.0) <sup>*1</sup> /1,630 (64.2) <sup>*2</sup>	
Tread	Tire size	Front	Rear
	235/55 R19	1,647 (64.8)	1,661 (65.4)
	265/45 R20	1,643 (64.7)	1,657 (65.2)
Wheelbase		2,875 (113.2)	

\*1: for 265/45 R 20 tire

\*2: for 235/55 R 19 tire

## ELECTRIC VEHICLE SPECIFICATIONS

Items		AWD
Motor	Max. output (kW)	180
	Max. torqu (Nm)	350
Battery (Lithium-ion)	Capacity (kWh)	77.4
	Power output (kW)	394
	Voltage (V)	697
Charger (OBC)	Max. output (kW)	10.5

OBC : On-Board Battery Chargers

## BULB WATTAGE

Light bulb		Bulb type	Wattage
Front	Headlamp	Low	LED
		High	LED
	Turn signal lamp		LED
	Position lamp		LED
	Daytime Running Lamp (DRL)		LED
	Puddle lamp		LED
	Side repeater lamp		LED
Rear	Stop lamp		LED
	Tail lamp		LED
	Turn signal lamp		LED
	Backup lamp		LED
	License plate lamp		LED
	Fog lamp		LED
	High mounted stop lamp		LED
Interior	Map lamp		LED
	Room lamp (without sunroof)		LED
	Personal lamp (with sunroof)		LED
	Vanity mirror lamp		LED
	Glove box lamp		LED
	Mood lamp		LED
	Luggage compartment lamp		LED
Front trunk lamp		LED	

## TIRES AND WHEELS

Items	Tire size	Wheel size	Inflation pressure kPa (psi)				Wheel bolt torque [kgf·m (lbf·ft, N·m)]
			Normal load		Maximum load		
			Front	Rear	Front	Rear	
Full size tire	235/55 R19	8.0J x 19	230 (33)	270 (39)	250 (36)	280 (41)	14~16 (101~116, 137~157)
	265/45R20	8.5J x 20	230 (33)	250 (36)	240 (35)	260 (38)	

### NOTICE

- Ambient temperature affects the tire pressure (about 7kPa (psi) for every 7°C (12°F) change). If colder temperatures are anticipated, it is permissible to increase cold tire inflation pressure by up to 20 kPa (3 psi) over the specification. If extreme temperature changes are expected, be sure to check and adjust tire pressure accordingly.
- Tire inflation pressure decreases with higher elevation, and increases with lower elevation (about 10 kPa (2.4 psi) for every kilometer (or mile) elevation change). Be sure to check and adjust tire pressure accordingly when driving through changing elevations.
- Do not exceed the maximum inflation pressure, as found on the sidewall of the tire(s).



### CAUTION

When replacing tires, ALWAYS use the same size, type, brand, construction and tread pattern supplied with the vehicle. If not, it can damage the related parts or make it work irregularly.

## LOAD AND SPEED CAPACITY TIRES (FOR EUROPE)

Items	Tire size	Wheel size	Load capacity		Speed capacity	
			LI *1	kg	SS *2	km/h
Full size tire	235/55 R19	8.0J x 19	105	925	W	270
	265/45R20	8.5J x 20	108	925	W	270

\*1 LI : LOAD INDEX

\*2 SS : SPEED SYMBOL

## AIR CONDITIONING SYSTEM

g (oz.)

Item	Weight of volume	Classification
Refrigerant	900 g (32 oz.)	R-1234yf
		R-134a
Compressor lubricant	180 g (6.3 oz.)	POE RB100EV

We recommend that you contact an authorized retailer of Genesis Branded products dealer for more details.

## VEHICLE WEIGHT AND LUGGAGE VOLUME

Gross vehicle weight	Luggage volume
2,845 kg (6,272 lbs.)	503 ℓ (17.8 cu ft)

### Information

Elevator type automated parking is not possible due to the weight of the vehicle.

## RECOMMENDED LUBRICANTS AND CAPACITIES

To help achieve proper vehicle performance and durability, use only lubricants of the proper quality.

These lubricants and fluids are recommended for use in your vehicle.

Lubricant		Volume	Classification
Reduction gear fluid	AWD	Front	2.9 ℓ (3.2 US qt.)
		Rear	2.8 ℓ (3.0 US qt.)
Coolant	AWD	Motor and reduction gear system	4.61 ℓ (4.87 US qt.)
		Battery system	12.17 ℓ (12.86 US qt.)
Brake fluid		As required	SAE J1704 DOT-4 LV, FMVSS 116 DOT-4, ISO 4925 CLASS-6

## VEHICLE IDENTIFICATION NUMBER (VIN)

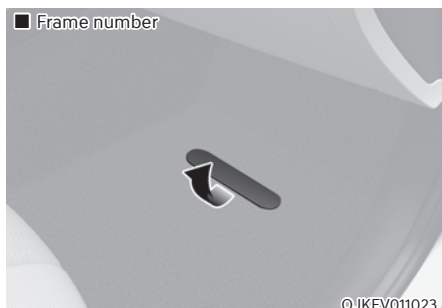

The vehicle identification number (VIN) is the number used in registering your vehicle and in all legal matters pertaining to its ownership, etc.

The number is punched on the floor under glove box. To check the number, open the cover.



The VIN is also on a plate attached to the top of the left side dashboard. The number on the plate can easily be seen through the windshield from outside.

## VEHICLE CERTIFICATION LABEL



The vehicle certification label attached on the driver's (or front passenger's) side center pillar gives the vehicle identification number (VIN).



### TIRE SPECIFICATION AND PRESSURE LABEL



The tires supplied on your new vehicle are chosen to provide the best performance for normal driving. The tire label located on the driver's side center pillar gives the tire pressures recommended for your vehicle.

### MOTOR NUMBER

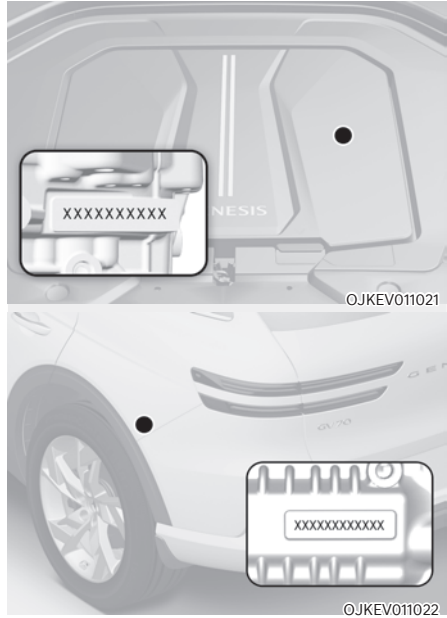

The motor number are stamped as shown in the drawing.

## AIR CONDITIONER COMPRESSOR LABEL

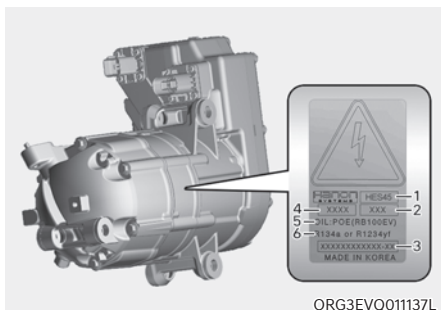

A compressor label informs you the type of compressor your vehicle is equipped with such as model (1), serial number (2), supplier part number (3), lot number (4), refrigerant (5) and refrigerant oil (6).

## REFRIGERANT LABEL (IF EQUIPPED)



You can find out which air conditioning refrigerant is applied to your vehicle on the label located inside of the hood.

## DECLARATION OF CONFORMITY (IF EQUIPPED)

■ Example



CE CE 0678

CE0678

The radio frequency components of the vehicle comply with requirements and other relevant provisions of Directive 1995/5/EC.

Further information including the manufacturer's declaration of conformity is available on Genesis Branded Vehicle web site as follows;

<http://service.hyundai-motor.com>

## OPEN SOURCE SOFTWARE NOTICE

This vehicle contains software with open source licenses.

Open source software information including the source code, copyright notices and referred license terms may be obtained on the website

<https://www.genesis.com/worldwide/en/opensource.html>

Hyundai Motor Company will provide the open source code to you in storage medium such as CD-ROM for minimum charge covering the cost of performing source distribution upon email request to [opensource@genesis.com](mailto:opensource@genesis.com) within a period of 3 years from the date of product purchase.

# 3. Safety system

- Important safety precautions ..... 3-3
  - Always wear your seat belt ..... 3-3
  - Restrain all children..... 3-3
  - Air bag hazards..... 3-3
  - Driver distraction..... 3-3
  - Control your speed..... 3-3
  - Keep your vehicle in safe condition ..... 3-3
- Seats ..... 3-4
  - Safety precautions ..... 3-7
  - Front seats ..... 3-8
  - Rear seats ..... 3-15
  - Headrest..... 3-18
- Seat warmers ..... 3-23
  - Front seat warmers ..... 3-23
  - Rear seat warmers..... 3-24
  - Operating rear seat warmer from front seat ..... 3-24
- Air ventilation seats ..... 3-26
  - Front air ventilation seats ..... 3-26
- Seat belts ..... 3-28
  - Seat belt safety precautions ..... 3-28
  - Seat belt warning light..... 3-29
  - Seat belt restraint system ..... 3-31
  - Pre-Active Seat Belt (PSB) ..... 3-35
  - Additional seat belt safety precautions ..... 3-36
  - Care of seat belts..... 3-38
- Child Restraint System (CRS) ..... 3-39
  - Our recommendation: Children always in the rear ..... 3-39
  - Selecting a Child Restraint System (CRS)..... 3-40
  - Installing a Child Restraint System (CRS) ..... 3-42

Air bag - supplemental restraint system .....	3-51
Where are the air bags? .....	3-54
How does the air bag system operate?.....	3-59
What to expect after an air bag inflates .....	3-62
Do not install a Child Restraint System on the front passenger seat .....	3-63
Why didn't my air bag go off in a collision?.....	3-64
SRS care .....	3-69
Additional safety precautions.....	3-70
Air bag warning labels.....	3-70
Active hood lift system .....	3-71
System activation .....	3-71
System limitation.....	3-72
System malfunction .....	3-73

## IMPORTANT SAFETY PRECAUTIONS

You will find many safety precautions and recommendations throughout this section, and throughout this manual. The safety precautions in this section are among the most important.

### Always wear your seat belt

A seat belt is your best protection in all types of accidents. Air bags are designed to supplement seat belts, not replace them. So even though your vehicle is equipped with air bags, ALWAYS make sure you and your passengers wear your seat belts, and wear them properly.

### Restrain all children

All children under age 13 should ride in your vehicle properly restrained in a rear seat, not the front seat. Infants and small children should be restrained in an appropriate Child Restraint System. Larger children should use a booster seat with the lap/shoulder belt until they can use the seat belt properly without a booster seat.

### Air bag hazards

While air bags can save lives, they can also cause serious or fatal injuries to occupants who sit too close to them, or who are not properly restrained. Infants, young children, and short adults are at the greatest risk of being injured by an inflating air bag. Follow all instructions and warnings in this manual.

### Driver distraction

Driver distraction presents a serious and potentially deadly danger, especially for inexperienced drivers. Safety should be the first concern when behind the wheel and drivers need to be aware of the wide array of potential distractions, such as drowsiness, reaching for objects, eating, personal grooming, other passengers, and using mobile phones.

Drivers can become distracted when they take their eyes and attention off the road or their hands off the wheel to focus on activities other than driving. To reduce your risk of distraction and an accident:

- ALWAYS set up your mobile devices (for example, MP3 players, phones, navigation units, etc.) when your vehicle is parked or safely stopped.
- ONLY use your mobile device when allowed by laws and conditions permit safe use. NEVER text or email while driving. Most countries have laws prohibiting drivers from texting. Some countries and cities also prohibit drivers from using handheld phones.
- NEVER let the use of a mobile device distract you from driving. You have a responsibility to your passengers and others on the road to always drive safely, with your hands on the wheel as well as your eyes and attention on the road.

### Control your speed

Excessive speed is a major factor in crash injuries and deaths. Generally, the higher the speed, the greater the risk, but serious injuries can also occur at lower speeds. Never drive faster than is safe for current conditions, regardless of the maximum speed posted.

### Keep your vehicle in safe condition

Having a tire blowout or a mechanical failure can be extremely hazardous. To reduce the possibility of such problems, check your tire pressures and condition frequently, and perform all regularly scheduled maintenance.

## SEATS



OJKEV032001L

### Front seat

- (1) Seat sliding forward or rearward/  
Seat cushion tilt/  
Seat cushion height
- (2) Seatback angle
- (3) Seat cushion extension/  
Seat cushion support
- (4) Lumbar support
- (5) Seatback bolster
- (6) Comfortable stretch
- (7) Seat warmer/Air ventilation seat
- (8) Headrest
- (9) Walk-in seat switch
- (10) Rear adjustment

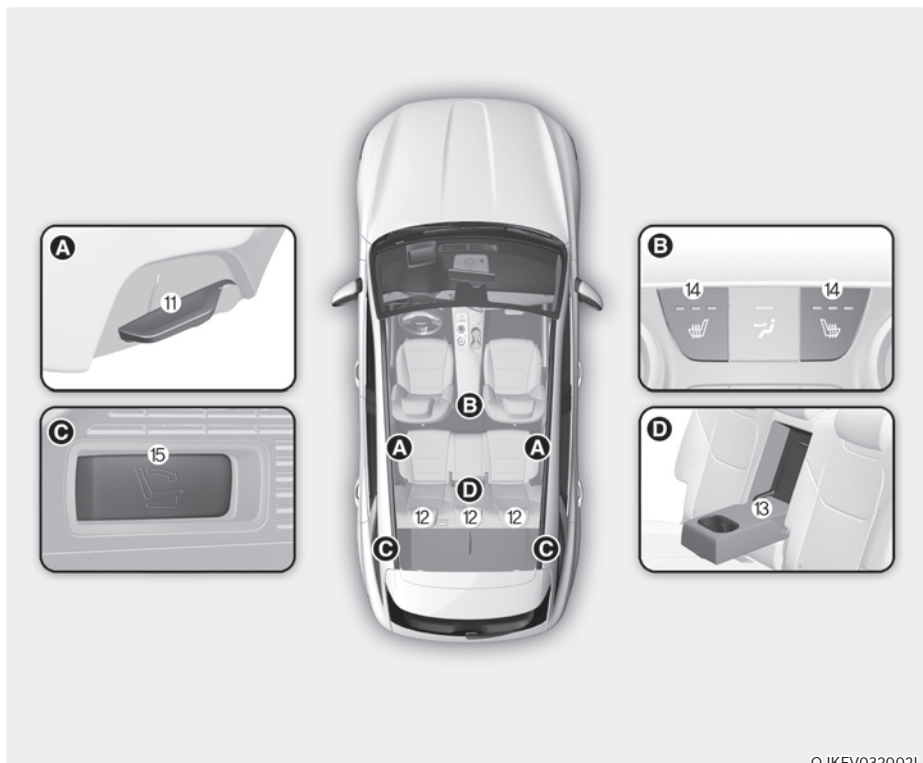
**Rear seat**

(11) Seatback angle (Manual)

(12) Headrest

(13) Armrest

(14) Seat warmer

(15) Seatback remote folding lever



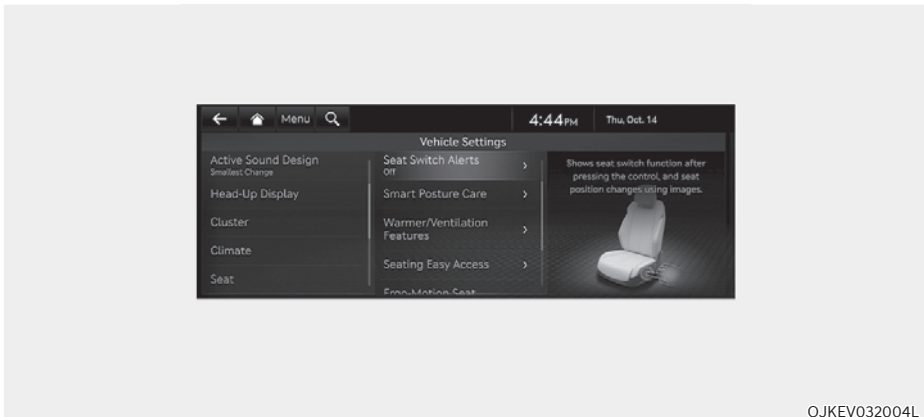

### Infotainment system

Select 'Setup → Vehicle Settings → Seat' from the Settings menu in the infotainment system screen, you may use various convenience functions.

- Seat position change alert: Seat change information is displayed.
- Seat switch and movement alert: Detailed information of the seat switch and image is displayed when the switch is touched or the switch is moved.
- Warmer/Vent. features
  - Automatic controls linked to climate control settings: The seat temperature is automatically controlled.
  - Seat heater balance: When the seat heater is on, you may lower the seat heater (warmer) setting, or may turn the seat heater off for either the seatback or seat cushion.
- Seating easy access
  - Steering easy access: Moves the steering wheel when the driver enters or leaves the vehicle.
  - Driver seat: The distance (Normal/Extended/Off) the seat automatically moves when the driver enters or leaves the vehicle may be selected.
- Ergo-motion seat
  - Comfortable stretch: The operation intensity and operation time for Comfortable Stretch may be selected.
  - Smart posture assist: The seat is adjusted to assist the driver's posture after driving for an hour.
  - Smart support: The driver's seat bolster is increased when SPORT mode is selected or when driving at high speed.

For detailed information, scan the QR code in the separately supplied simple manual.

### Information

The information provided may differ depending on which functions are applicable to your vehicle.

### Safety precautions

Adjusting the seats so that you are sitting in a safe and comfortable position plays an important role for the safety of the driver and passengers, along with seat belts and air bags when in an accident.

### WARNING

Do not use a cushion that reduces friction between the seat and the passenger. The passenger's hips may slide under the lap portion of the seat belt during an accident or a sudden stop.

Serious or fatal internal injuries could result because the seat belt cannot operate properly.

### *Air bags*

You can take steps to reduce the risk of being injured by an inflating air bag. Sitting too close to an air bag greatly increases the risk of injury in the event the air bag inflates. Move your seat as far back as possible from front air bags, while still maintaining control of the vehicle.

### WARNING

To reduce the risk of serious injury or death from an inflating air bag, take the following precautions:

- Adjust the driver's seat as far to the rear as possible while maintaining the ability to control the vehicle.
- Adjust the front passenger seat as far to the rear as possible.
- Hold the steering wheel by the rim with your hands at the 9 o'clock and 3 o'clock positions to minimize the risk of injuries to your hands and arms.
- NEVER place anything or anyone between you and the air bag.
- Do not allow the front passenger to place feet or legs on the dashboard to minimize the risk of leg injuries.

### *Seat belts*

Always fasten your seat belt before starting any trip. At all times, passengers should sit upright and be properly restrained. Infants and small children must be restrained in appropriate Child Restraint Systems. Children who have outgrown a booster seat and adults must be restrained using the seat belts.

### WARNING

Take the following precautions when adjusting your seat belt:

- NEVER use one seat belt for more than one occupant.
- Always position the seatback upright with the lap portion of the seat belt snug and low across the hips.
- NEVER allow children or small infants to ride on a passenger's lap.
- Do not route the seat belt across your neck, across sharp edges, or reroute the shoulder strap away from your body.
- Do not allow the seat belt to become caught or jammed.

## Front seats

The front seat can be adjusted by using the control switches located on the outside of the seat cushion. Before driving, adjust the seat to the proper position so that you can easily control the steering wheel, foot pedals and controls on the instrument panel.



### WARNING

Take the following precautions when adjusting your seat:

- **NEVER attempt to adjust the seat while the vehicle is moving.** The seat could respond with unexpected movement and may cause loss of vehicle control resulting in an accident.
- Do not place anything under the front seats. Loose objects in the driver's foot area could interfere with the operation of the foot pedals, causing an accident.
- Do not allow anything to interfere with the normal position and proper locking of the seatback.
- Do not place a cigarette lighter on the floor or seat. When you operate the seat, gas may exit out of the lighter causing a fire.
- Use extreme caution when picking up small objects trapped under the seats or between the seat and the center console. Your hands might be cut or injured by the sharp edges of the seat mechanism.
- If there are occupants in the rear seats, be careful while adjusting the front seat position.
- Make sure that the seat is locked in place after the adjustment. If not, the seat might move unexpectedly resulting in an accident.



### CAUTION

To prevent injury:

- Do not adjust your seat while wearing your seat belt. Moving the seat cushion forward may cause strong pressure on your abdomen.
- Do not allow your hands or fingers to get caught in the seat mechanisms while the seat is moving.



### WARNING

**NEVER** allow children in the vehicle unattended. The power seats are operable when the vehicle is turned off.

### NOTICE

To prevent damage to the seats:

- Always stop adjusting the seats when the seat has been adjusted as far forward or rearward as possible.
- Do not adjust the seats longer than necessary when the vehicle is turned off. This may result in unnecessary battery drain.
- Do not operate two or more seats at the same time. This may result in an electrical malfunction.

**Forward and rearward adjustment**

To move the seat forward or rearward:

1. Push the control switch forward or rearward.
2. Release the switch once the seat reaches the desired position.

**Seat cushion tilt/height adjustment****Seat cushion tilt (1)**

To change the angle of the front part of the seat cushion:

Push the front portion of the control switch up to raise or down to lower the front part of the seat cushion.

Release the switch once the seat reaches the desired position.

**Seat cushion height (2)**

To change the height of the seat cushion:

Push the rear portion of the control switch up to raise or down to lower the height of the seat cushion.

Release the switch once the seat reaches the desired position.

### Seatback angle adjustment



To recline the seatback:

1. Push the control switch forward or rearward.
2. Release the switch once the seatback reaches the desired position.

#### Reclining seatback

Sitting in a reclined position when the vehicle is in motion can be dangerous. Even when buckled up, the protections of your restraint system (seat belts and air bags) is greatly reduced by reclining your seatback.



#### **WARNING**

**NEVER ride with a reclined seatback when the vehicle is moving.**

**Riding with a reclined seatback increases your chance of serious or fatal injuries in the event of a collision or sudden stop.**

**Driver and passengers should always sit well back in their seats with the seatbacks upright and should be belted properly.**

Seat belts must be snug against your hips and chest to work properly. When the seatback is reclined, the shoulder belt cannot do its job because it will not be snug against your chest. Instead, it will be in front of you. During an accident, you could be thrown into the seat belt, causing neck or other injuries.

The more the seatback is reclined, the greater chance the passenger's hips will slide under the lap belt or the passenger's neck will strike the shoulder belt.

### Seat cushion extension adjustment (if equipped)

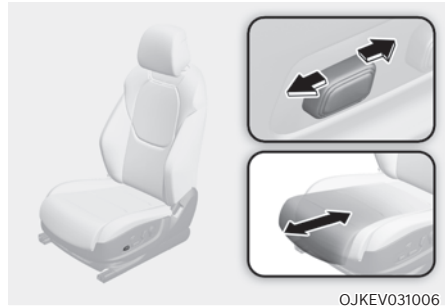

To move the front part of the cushion forward or rearward:

1. Push the control switch forward or rearward.
2. Release the switch once the seat cushion reaches the desired length.

### Seat cushion support adjustment (if equipped)



To adjust cushion support:

1. Push the control switch up to increase cushion support or down to decrease cushion support.
2. Release the switch once the seat cushion support reaches the desired position.

### Lumbar support (if equipped)

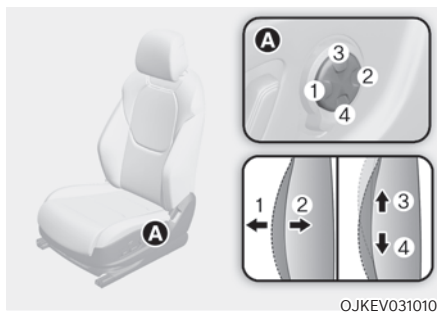

To adjust the lumbar support:

1. Press the front portion of the switch (1) to increase support or the rear portion of the switch (2) to decrease support.
2. Press switch (3) or (4) to move the support position up or down.
3. Release the switch once the lumbar support reaches the desired position.

**Seat bolster adjustment (if equipped)**



OJKEV031011

To adjust seat bolster:

1. Push the adjustment lever clockwise, the seatback bolster will be adjusted inward. Push the switch counterclockwise, the seatback bolster will be adjusted outward.
2. Release the lever once the bolster reaches the desired position.

**Ergo-motion seat (if equipped)**

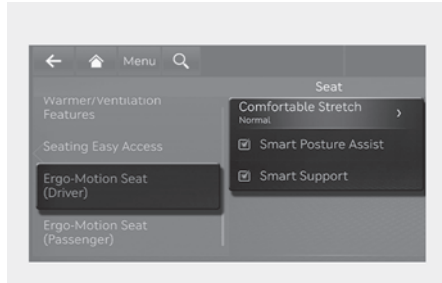

OJKEV032013L

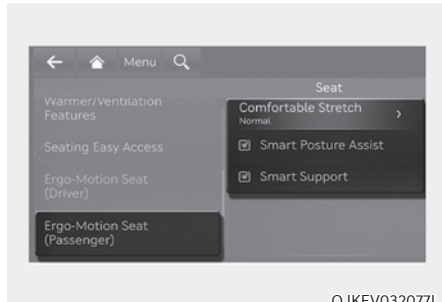

OJKEV032077L

Select 'Ergo-Motion Seat' from the infotainment system's Settings menu to select and set up supplemental functions for the driver.

 **WARNING**

**Before actually using each function, try the functions with the vehicle parked.**

### Comfortable stretch

Comfortable stretch is a function that helps relieve fatigue of the driver's pelvis and lower back due to driving.



OJKEV031012

Every time you press the button, you may select a mode or turn off the function in the following order.

- Pelvic stretching: The cushion portion moves, helping the left and right movement of the pelvis.
- Lumbar stretching: The seatback portion moves, helping back and forth movement of the lower back.
- Whole Body stretching: The cushion and seatback moves in sequence, helping the whole body reduce fatigue.
- Off: Turns off Comfortable Stretch.

Also, you can change the operation intensity and operation time from the Settings menu in the infotainment system screen.

- Intensity: Setup → Vehicle Settings → Seat → Ergo-Motion Seat → Comfortable Stretch → Strong/Normal
- Time: Setup → Vehicle Settings → Seat → Ergo-Motion Seat → Comfortable Stretch → Operational Time → Short(10s)/Long(20s)

### Smart posture assist

After driving for an hour, Smart posture assist automatically adjusts the pelvis and back portion of the driver's seat to assist the driver's posture.

You can activate or deactivate Smart posture assist function from the Settings menu in the infotainment system screen. Select:

- Setup → Vehicle Settings → Seat → Ergo-Motion Seat → Smart Posture Assist

### Smart support

The driver's seat bolster support increases when SPORT mode is selected for Drive Mode and when driving at high speed.

You can activate or deactivate Posture Assist function from the Settings menu in the infotainment system screen. Select:

- Setup → Vehicle Settings → Seat → Ergo-Motion Seat → Smart Support



**Walk-in switch (if equipped)**



OJKEV031019

The rear seat passenger may use the switches to control the front passenger seat.

- Sliding forward or rearward:  
Press the switch (1) or (2) to move the front passenger seat forward or rearward.
- Seatback angle:  
Press the switch (3) or (4) to recline the front passenger seatback forward or rearward.



**WARNING**

**The rear passenger should not adjust the front seat when a passenger is seated.**

**Seatback pocket**

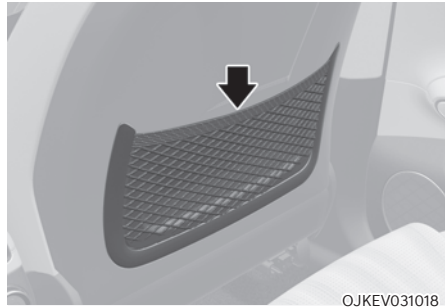

OJKEV031018

The seatback pocket is provided on the back of the front seatbacks.



**CAUTION**

**Do not put heavy or sharp objects in the seatback pockets. In an accident they could come loose from the pocket and injure occupants.**

## Rear seats



### WARNING

Take the following precautions:

- **Adjusting the seats**
  - NEVER attempt to adjust the seat while the vehicle is moving. The seat may suddenly move and may injure the passenger.
  - Make sure that the seat is locked in place after the adjustment. If not, the seat might move unexpectedly resulting in an accident.
- **Folding the seats**
  - Do not fold the seatback when the seat is occupied (for example, passenger, pets or luggage). It may injure the passenger or pet, or damage the luggage.
  - Never allow passengers to sit on top of the folded down seatback while the vehicle is moving. This is not a proper seating position and no seat belts are available for use. This could result in serious injury or death in case of an accident or sudden stop.
  - Objects carried on the folded down seatback should not extend higher than the top of the front seatbacks. This could allow cargo to slide forward and cause injury or damage during sudden stops.
- When returning the rear seatback from a folded to an upright position, hold the seatback and return it slowly. Ensure that the seatback is completely locked into its upright position by pushing on the top of the seatback. In an accident or sudden stop, the unlocked seatback could allow cargo to move forward with great force and enter the passenger compartment, which could result in serious injury or death.
- **Loading cargo**
  - Make sure the vehicle is off, the gear shifted to P (Park), and the parking brake is securely applied whenever loading or unloading cargo. Failure to take these steps may allow the vehicle to move if the shift button or shift dial is inadvertently pressed or rotated to another position.
  - When cargo is loaded through the rear passenger seats, ensure the cargo is properly secured to prevent it from moving while driving.
- Do not place objects in the rear seats, since they cannot be properly secured and may hit vehicle occupants in a collision causing serious injury or death.



### CAUTION

Do not allow your hands or fingers to get caught in the seat mechanisms while adjusting the seats.

**NOTICE**

To prevent damage to the vehicle:

- **Rear seat belts**  
Before folding the seatback, insert the seat belt buckle in the holder between the seatback and cushion. And insert the seat belt webbing in the guide to prevent the seat belt from being damaged.
- **Cargo**  
Be careful when loading cargo through the rear passenger seats to prevent damage to the vehicle interior.

**Manual adjustment**

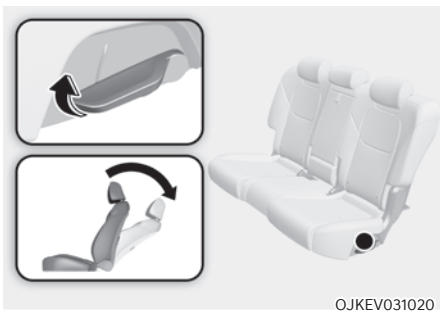

**Seatback angle**

To recline the seatback:

1. Pull up the seatback recline lever.
2. Hold the lever and adjust the seatback of the seat to the position you desire.
3. Release the lever and make sure the seatback is locked in place. The lever MUST return to its original position for the seatback to lock.

\* The seatbacks can be folded with the seatback recline lever.

**Folding the rear seats**

The rear seatbacks can be folded to facilitate carrying long items or to increase the luggage capacity of the vehicle.

To fold down the rear seatback:

1. Set the front seatback to the upright position and if necessary, slide the front seat forward.



2. Lower the rear headrests to the lowest position.



3. Route the seat belt webbing through the rear seat belt guides to prevent the belts from being trapped behind or under the seats.

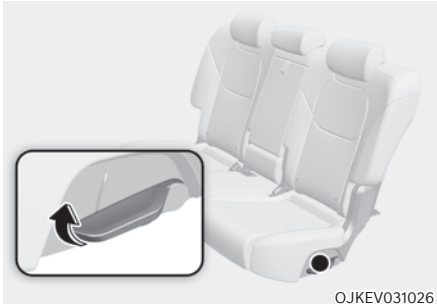

OJKEV031026

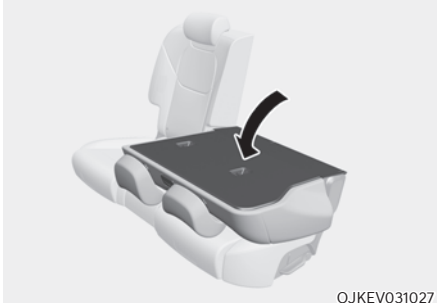

OJKEV031027

4. Pull up the seatback folding lever, then fold the seat toward the front of the vehicle. When you return the seatback to its upright position, always be sure it has locked into position by pushing on the top of the seatback.

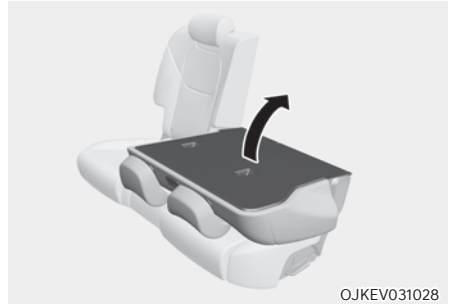

OJKEV031028

5. To use the rear seat, lift and unfold the seatback to the upright position by pulling up the folding lever. Push the seatback firmly until it clicks into place. Make sure the seatback is locked in place.
6. Return the rear seat belt to the proper position.

### ***Seatback remote folding***



OJKEV031029

Pull the rear seat back folding switch located in the both sides of the cargo area.

### Armrest



The armrest is located in the center of the rear seat. Pull the armrest down from the seatback to use it.

### Headrest

The vehicle's front and rear seats have adjustable headrests. The headrests provide comfort for passengers, but more importantly they are designed to help protect passengers from whiplash and other neck and spinal injuries during an accident, especially in a rear impact collision.

#### **WARNING**

**To help reduce the risk of serious injury or death in an accident, take the following precautions when adjusting your headrests:**

- **Always properly adjust the headrests for all passengers BEFORE starting the vehicle.**
- **NEVER let anyone ride in a seat with the headrest removed or reversed.**

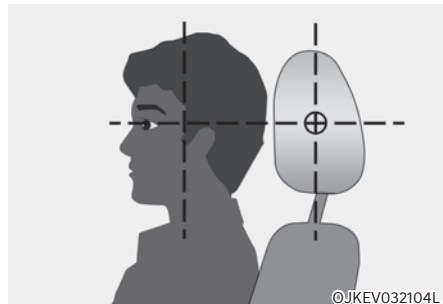

- **Adjust the headrests so the middle of the headrest is at the same height as the height of the top of the eyes.**
- **NEVER adjust the headrest position of the driver's seat when the vehicle is in motion.**
- **Adjust the headrest as close to the passenger's head as possible. Do not use a seat cushion that holds the body away from the seatback.**
- **Make sure the headrest locks into position after adjusting it.**

 **WARNING**



When sitting on the rear seat, do not adjust the height of the headrest to the lowest position.

 **CAUTION**

When there is no occupant in the rear seats, adjust the height of the headrest to the lowest position. The rear seat headrest can reduce the visibility of the rear area.

**NOTICE**

To prevent damage, NEVER hit or pull on the headrests.

*Front seat headrests*

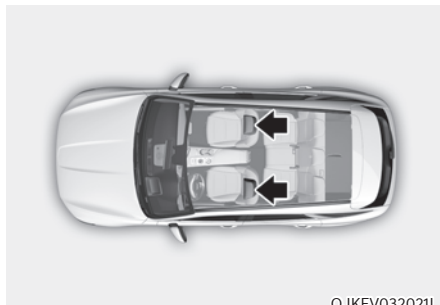

The driver's and front passenger's seats are equipped with adjustable headrests for the passengers safety and comfort.

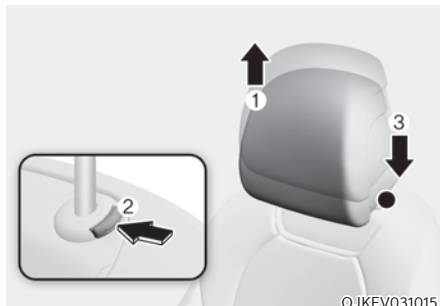

**Adjusting the height up and down**

To raise the headrest:

1. Pull it up to the desired position (1).

To lower the headrest:

1. Push and hold the release button (2) on the headrest support.
2. Lower the headrest to the desired position (3).

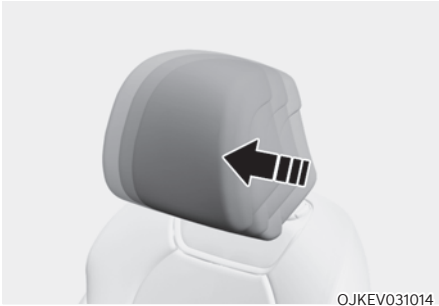

**Forward and rearward adjustment**

The headrest may be adjusted forward to 3 different positions by pulling the headrest forward to the desired detent. To adjust the headrest to it's furthest rearwards position, pull it fully forward to the farthest position and release it.

**NOTICE**

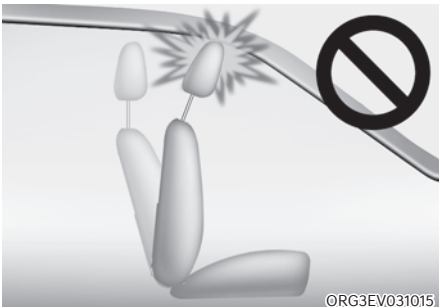

**If you recline the seatback towards the front with the headrest and seat cushion raised, the headrest may come in contact with the sunvisor or other parts of the vehicle.**



**Removal**

To remove the headrest:

1. Recline the seatback (2) with the seatback angle switch (1).
2. Raise the headrest as far as it can go.
3. Press the headrest release button (3) while pulling the headrest up (4).

**⚠ WARNING**

**NEVER allow anyone to travel in a seat with the headrest removed.**



### Reinstall

To reinstall the headrest :

1. Recline the seatback.
2. Put the headrest poles (2) into the holes while pressing the release button (1).
3. Adjust the headrest to the appropriate height.
4. Recline the seatback (4) with the seatback angle switch (3).



### WARNING

**Always make sure the headrest locks into position after reinstalling and adjusting it properly.**

### Rear seat headrests

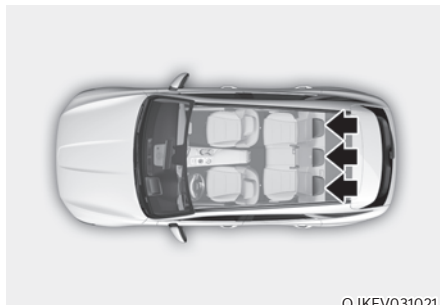

The rear seats are equipped with headrests in all the seating positions for the passenger's safety and comfort.

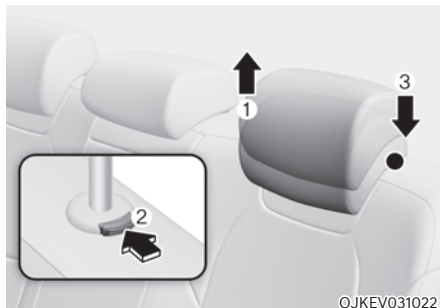

### Adjusting the height up and down

To raise the headrest:

1. Pull it up to the desired position (1).

To lower the headrest:

1. Push and hold the release button (2) on the headrest support.
2. Lower the headrest to the desired position (3).



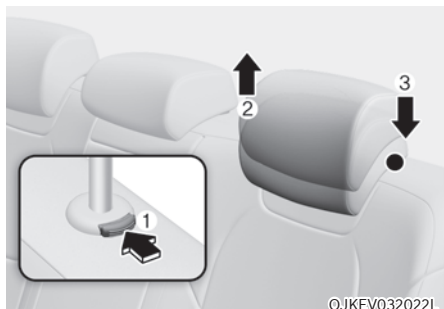

### Removal/Reinstallation

To remove the headrest:

1. Raise the headrest as far as it can go.
2. Press the headrest release button (1) while pulling the headrest up (2).

To reinstall the headrest:

1. Put the headrest poles into the holes (3) while pressing the release button (1).
2. Adjust the headrest to the appropriate height.

## SEAT WARMERS (IF EQUIPPED)

Use the heater and seat warmers when it is cold.

### Front seat warmers

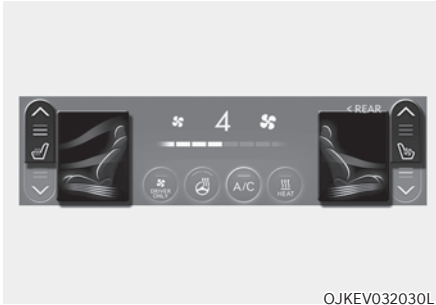

1. Press  $\wedge$  next to the desired seat from the climate control screen while the READY indicator is on.
  - Seat warmer is turned on to 'High'
2. Press  $\vee$  to lower the temperature and  $\wedge$  to raise.
  - Press and hold  $\wedge$  or  $\vee$  to turn off the seat warmer, or press  $\vee$  multiple times until the seat warmer is turned off.
  - The seat warmer is automatically turned off if the seat temperature goes above a certain level. The seat warmer turns on again if the temperature is low.
  - To turn on the seat warmer when the seat ventilation is turned on, press  $\wedge$  until the seat warmer is turned on. (if equipped)

### **i** Information

- The seat warmer temperature is lowered automatically after a certain time to prevent low temperature burn. Press  $\wedge$  or  $\vee$  from the climate control screen to adjust the temperature again. The temperature will be adjusted automatically after a certain time after the temperature level is manually selected.
- Automatic Controls Linked to Climate Control Settings (for driver's seat)

The seat warmer automatically controls the seat temperature depending on the ambient temperature when the vehicle is running.

To use this function, it must be enabled from the Settings menu in the infotainment system screen.

Select:

Setup  $\rightarrow$  Vehicle  $\rightarrow$  Seat  $\rightarrow$  Warmer/  
Ventilation Features  $\rightarrow$  Automatic  
Controls Linked to Climate Control  
Settings  $\rightarrow$  Driver Seat Warmer/  
Ventilation

- Seat Warmer Balance

You may lower the seat warmer setting, or may turn the seat warmer off for either the seatback or seat cushion, when the seat warmer is on.

To use this function, it must be enabled from the Settings menu in the infotainment system screen.

Select:

Setup  $\rightarrow$  Vehicle  $\rightarrow$  Seat  $\rightarrow$  Warmer/  
Ventilation Features  $\rightarrow$  Seat Warmer  
Balance

- The seat warmer defaults to the OFF position whenever the Start/Stop button is pressed to the ON position. However, if the Automatic Controls Linked to Climate Control Settings function is ON, the driver's seat warmer will turn on and off depending on the ambient temperature.

## Rear seat warmers

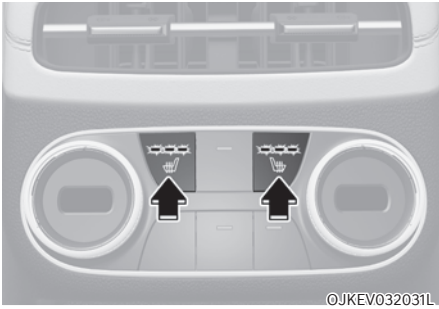

With the READY indicator on, press the seat warmer button on the center console to select the desired temperature level.

- The temperature can be set to HIGH/MEDIUM/LOW. The seat temperature will change from high, medium, low, and to off each time the button is pressed.
- Press and hold the button to turn off the seat warmer.

### **i** Information

- **The seat warmer temperature is lowered automatically after a certain time to prevent low temperature burn.**
- **The seat warmer is turned off if the driver restarts the vehicle with the seat warmer on.**

## Operating rear seat warmer from front seat

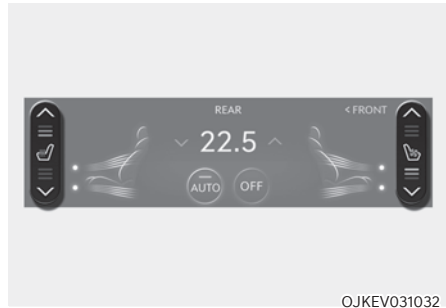

Rear seat warmers can be turned on or off from the front seat.

1. Press 'REAR' from the upper part of the climate control screen while the READY indicator is on.
  - The climate control screen for the rear seat is displayed.
2. Press ^ next to the desired seat from the climate control screen.
  - Seat warmer is turned on to 'HIGH'.

3. Press  $\wedge$  to raise and  $\vee$  to lower the temperature.
  - Press and hold  $\wedge$  or  $\vee$  to turn off the seat warmer, or press  $\vee$  multiple times until the seat warmer is turned off.
  - The seat warmer is automatically turned off if the seat temperature goes above a certain level. The seat warmer is turned on again if the temperature is low.
  - To turn on the seat warmer when the seat ventilation is turned on, press  $\wedge$  until the seat warmer is turned on. (if equipped)



### WARNING

- The seat warmer may inflict low temperature burn when the passengers are in the following situations.
  - Infants, children, seniors, or other handicapped or ill passengers.
  - Passengers with delicate skin.
  - Exhausted passengers.
  - Drunken passengers.
  - Passengers who have taken a drowsy medication such as a sleeping pill or cold medicine.
- Do not replace the seat covers. The heat wires may be damaged and lead to fire.



### Information

Low temperature burn occurs when the skin is exposed to relatively low temperature (40 - 50°C). The passenger may get burned before feeling any heat or pain. Be careful not to use the seat warmers for a long time.



### CAUTION

- Do not place any heavy, bumpy, and sharp objects on the seat. It may damage the seat warmer.
- Do not use organic solvents such as thinner, benzene, alcohol, or gasoline to clean the seats. It may damage the seat warmer.
- Do not cover the seats with blankets or cushions. The seat could be overheated which may damage the seat warmer or cause low temperature burns.
- If water or any liquid is spilled over the seat, turn off the seat warmer and wipe it out with dry towels. The seat then must be completely dried.
- It is recommended to use the heater and the seat warmer together. Using the seat warmer only for a long time may reduce its performance.
- The seat warmer consumes a lot of electricity. Refrain from using the seat warmer while the vehicle is turned off to prevent the battery from being discharged.
- To switch from seat warmer to seat ventilator or vice-versa, it is recommended to turn the function off and turn the other one on. Frequently shifting from one function to another may lead to a malfunction or a performance degradation.

## AIR VENTILATION SEATS

Use the air conditioner with the seat ventilators when it is hot.

### Front air ventilation seats



1. Press  $\wedge$  next to the desired seat from the climate control screen while the READY indicator is on.
  - The seat ventilator is turned on to 'HIGH'.
2. Press  $\wedge$  to raise and  $\vee$  to lower the fan speed.
  - Press and hold  $\vee$  or  $\wedge$  to turn off the seat ventilator, or press  $\wedge$  multiple times until the seat ventilator is turned off.
  - The seat ventilator is automatically turned off if the seat temperature goes below a certain level. The seat ventilator is turned on again if the temperature rises.

### **i** Information

- The vehicle speed and driving time influences the fan speed if the seat ventilator is set to 'HIGH'. (For example, the fan speed is raised when the vehicle drives faster)
- After the seat ventilator is turned on, it takes 3 – 5 minutes for the passengers to notice the temperature change.
- It is recommended to use the air conditioner and seat ventilator together for efficient cooling.
- Automatic Controls Linked to Climate Control Settings (for driver's seat)

The air ventilation seat automatically controls the seat temperature depending on the ambient temperature when the vehicle is running.

To use this function, it must be enabled from the Settings menu in the infotainment system screen.

Select:

Setup → Vehicle → Seat → Warmer/  
Ventilation Features → Automatic  
Controls Linked to Climate Control  
Settings → Driver Seat Warmer/  
Ventilation

- The air ventilation seats default to the OFF position whenever the Start/Stop button is pressed to the ON position. However, if the Automatic Controls Linked to Climate Control Settings function is ON, the driver's seat warmer will turn on and off depending on the ambient temperature.

**CAUTION**

- Do not replace the seat cover. It may damage the seat ventilator.
- Do not place any heavy, bumpy, and sharp objects on the seat. It may damage the seat ventilator.
- Do not use organic solvents such as thinner, benzene, alcohol, or gasoline to clean the seats. It may damage the seat ventilator.
- If water or any liquid is spilled over the seat, turn off the seat ventilator and wipe it out with dry towels. The seat then must be completely dried.
- It is recommended to use the air conditioner and the seat ventilator together. Using the seat ventilator only for a long time may reduce its performance.
- The seat ventilator consumes a lot of electricity. Refrain from using the seat ventilator while the vehicle is turned off to prevent the battery from being discharged.
- Do not obstruct the intake vent behind the seatback. Seat ventilation performance may be reduced.
- To switch from seat warmer to seat ventilator or vice-versa, it is recommended to turn the function off and turn the other one on. Frequently shifting from one function to another may lead to a malfunction or performance degradation.

## SEAT BELTS

This section describes how to use the seat belts properly. It also describes some of the things not to do when using seat belts.

### Seat belt safety precautions

Always fasten your seat belt and make sure all passengers have fastened their seat belts before starting any trip. Air bags are designed to supplement the seat belt as an additional safety device, but they are not a substitute. Most countries require all occupants of a vehicle to wear seat belts.



#### WARNING

Seat belts must be used by **ALL** passengers whenever the vehicle is moving. Take the following precautions when adjusting and wearing seat belts:

- Children under the age of 13 should be properly restrained in the rear seats.
- Never allow children to ride in the front passenger seat, unless the air bag is deactivated. If a child is seated in the front passenger seat, move the seat as far back as possible and the child must always be restrained in the seat properly.
- **NEVER** allow an infant or child to be carried on an occupant's lap.
- **NEVER** ride with the seatback reclined when the vehicle is moving.
- Do not allow children to share a seat or seat belt.
- Do not wear the shoulder belt under your arm or behind your back.

- **Never wear a seat belt over fragile objects.** If there is a sudden stop or impact, the seat belt can damage it.
- Do not use the seat belt if it is twisted. A twisted seat belt will not protect you properly in an accident.
- Do not use a seat belt if the webbing or hardware is damaged.
- Do not latch the seat belt into the buckles of other seats.
- **NEVER** unfasten the seat belt while driving. This may cause loss of vehicle control resulting in an accident.
- Make sure there is nothing in the buckle interfering with the seat belt latch mechanism, because any materials in the buckle can cause the seat belt not to be fastened securely.
- No modifications or additions should be made by the user which will either prevent the seat belt adjusting devices from operating to remove slack, or prevent the seat belt assembly from being adjusted to remove slack.



#### WARNING

Damaged seat belts and seat belt assemblies will not operate properly. Always replace:

- Frayed, contaminated, or damaged webbing.
- Damaged hardware.
- The entire seat belt assembly after it has been worn in an accident, even if damage to webbing or assembly is not apparent.

## Seat belt warning light

### Driver's seat belt warning



As a reminder to the driver, the seat belt warning light will illuminate for approximately 6 seconds each time the Start/Stop button is in the ON position regardless of belt fastening.

If the driver's seat belt is not fastened, the warning chime will sound for about 6 seconds and the warning light will stay ON until the driver's seat belt is fastened.

If the seat belt is not fastened, when vehicle speed is between 9 km/h (5.5 mph) and 20 km/h (12 mph) the warning light will continue to illuminate and warning chime will sound until the seat belt is fastened.

If the seat belt is not fastened, when vehicle speed is above 20 km/h (12 mph), the warning light will blink and warning chime will sound for approximately 100 seconds (warning chime will sound in three stages).

### Front passenger's seat belt warning

As a reminder to the front passenger, the front passenger's seat belt warning light will illuminate for approximately 6 seconds each time the Start/Stop button is in the ON position regardless of belt fastening.

If the passenger's seat belt is not fastened, the warning light will stay ON until the passenger's seat belt is fastened.

If the seat belt is not fastened, when vehicle speed is above 20 km/h (12 mph), the warning light will blink and warning chime will sound for approximately 100 seconds (warning chime will sound in three stages).



### WARNING

**Riding in an improper position adversely affects the front passenger's seat belt warning system. It is important for the driver to instruct the passenger to be seated properly as instructed in this manual.**



### Information

- Although the front passenger seat is not occupied, the seat belt warning light will blink or illuminate for 6 seconds.
- The front passenger's seat belt warning may operate when luggage is placed on the front passenger seat.



**Rear passenger's seat belt warning (if equipped)**



**Rear left and right side seatbelt**

As a reminder to the rear seat passengers, the corresponding seat belt warning lights will illuminate for approximately 6 seconds each time the Start/Stop button is in the ON position regardless of belt fastening.

And then, if the seat belt is still not fastened while driving, or unfastened while driving, it will operate as follows depending on vehicle speed.

Below 20 km/h (12 mph):

The corresponding seat belt warning light will illuminate.

Above 20 km/h (12 mph):

The corresponding seat belt warning light will blink and the warning chime will sound for approximately 35 seconds, and the warning light will continue to illuminate until the seatbelt is fastened.

**Rear center seatbelt**

With the Start/Stop button in the ON position, if the rear center seat passenger's seat belt is not fastened, the corresponding seat belt warning light will illuminate for 70 seconds. But, if the seatbelt is fastened after 6 seconds, the corresponding seat belt warning light will immediately turn off.

If the seat belt is fastened, and then unfastened while driving below 20 km/h (12 mph), the corresponding seat belt warning light will illuminate.

If the seat belt is fastened, and then unfastened while driving above 20 km/h (12 mph), the corresponding seat belt warning light will blink and the warning chime will sound for approximately 35 seconds.

## Seat belt restraint system

### WARNING



**Improperly positioned seat belts may increase the risk of serious injury in an accident. Take the following precautions when adjusting the seat belt:**

- **Position the lap portion of the seat belt as low as possible across your hips, not on your waist, so that it fits snugly. This allows your strong pelvic bones to absorb the force of the crash, reducing the chance of internal injuries.**
- **Position one arm under the shoulder belt and the other over the belt, as shown in the illustration.**
- **Always position the shoulder belt anchor into the locked position at the appropriate height.**
- **Never position the shoulder belt across your neck or face.**

## Lap/shoulder belt

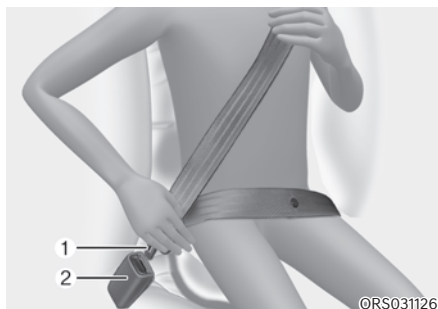

### To fasten your seat belt:

Pull it out of the retractor and insert the metal tab (1) into the buckle (2). There will be an audible “click” when the tab locks into the buckle.



You should place the lap belt (1) portion across your hips and the shoulder belt (2) portion across your chest.

The seat belt automatically adjusts to the proper length after the lap belt portion is adjusted manually so that it fits snugly around your hips. If you lean forward in a slow, easy motion, the belt will extend and move with you.

If there is a sudden stop or impact, the belt will lock into position. It will also lock if you try to lean forward too quickly.

**NOTICE**

If you are not able to smoothly pull enough of the seat belt out from the retractor, firmly pull the seat belt out and release it. After release, you will be able to pull the belt out smoothly.

**Height adjustment**

You can adjust the height of the shoulder belt anchor to one of the four different positions for maximum comfort and safety.

The shoulder portion should be adjusted so it lies across your chest and midway over your shoulder nearest the door, not over your neck.

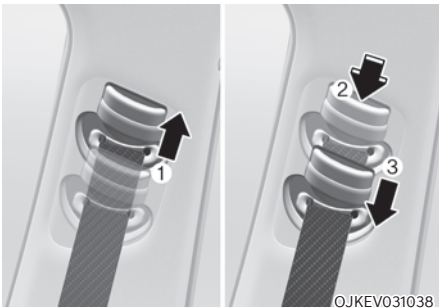

To adjust the height of the seat belt anchor, lower or raise the height adjuster into an appropriate position.

To raise the height adjuster, pull it up (1). To lower it, push it down (3) while pressing the height adjuster button (2).

Release the button to lock the anchor into position. Try sliding the height adjuster to make sure that it has locked into position.

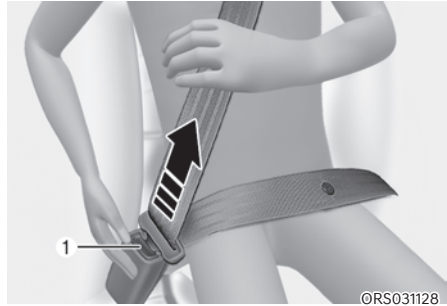

**To release your seat belt:**

Press the release button (1) in the locking buckle.

When it is released, the belt should automatically draw back into the retractor. If this does not happen, check the belt to be sure it is not twisted, then try again.

### Rear center seatbelt (3-point rear center seat belt)



ORS031048

1. Take out the buckle, which is stored between the seat/seatback cushions.
2. Insert the metal plate (1) into the buckle, until it clicks. You can make sure its secure fastening by pulling the seatbelt webbing. The buckle with 'CENTER' mark should be used for the 3-point seatbelt.
3. Restore the buckle between the seat/ seatback cushion after unfastening the seatbelt.

#### Information

**If you are not able to pull out the safety belt from the retractor, firmly pull the belt out and release it. After release, you will be able to pull the belt out smoothly.**

#### WARNING

**Make sure that the seatback is locked in place when using the rear center seat belt.**

**If not, the seatback may move when there is a sudden stop or collision, which could result in serious injury.**

### Pre-tensioner seat belt

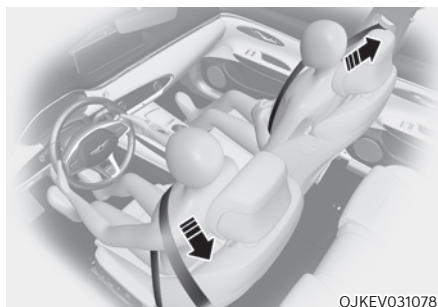

OJKEV031078

Your vehicle is equipped with driver's and front passenger's and rear passengers Pre-tensioner Seat Belts (Retractor Pre-tensioner). The purpose of the pre-tensioner is to make sure the seat belts fit tightly against the occupant's body in certain frontal or side collision(s). The pre-tensioner seat belts may be activated in crashes where the frontal or side collision(s) is severe enough, together with the air bags.

When the vehicle stops suddenly, or if the occupant tries to lean forward too quickly, the seat belt retractor will lock into position.

In certain frontal collisions, the pre-tensioner will activate and pull the seat belt into tighter contact against the occupant's body.

If the system senses excessive tension on the driver or passenger's seat belt when the pre-tensioner system activates, the load limiter inside the retractor pre-tensioner will release some of the pressure on the affected seat belt (if equipped with load limiter).

**⚠ WARNING**

- Always wear your seat belt and sit properly in your seat.
- Do not use the seat belt if it is loose or twisted. A loose or twisted seat belt will not protect you properly in an accident.
- Do not place anything near the buckle. This may adversely affect the buckle and cause it to function improperly.
- Always replace your pre-tensioners after activation or an accident.
- NEVER inspect, service, repair or replace the pre-tensioners by yourself. We recommend that you have the pre-tensioners inspected, serviced, repaired or replaced by an authorized retailer of Genesis Branded products.
- Do not hit the seat belt assemblies.

**⚠ WARNING**

Do not touch the pre-tensioner seat belt assemblies for several minutes after they have been activated. When the pre-tensioner seat belt mechanism deploys during a collision, the pre-tensioner can become hot and can burn you.

**⚠ CAUTION**

Body work on the front area of the vehicle may damage the pre-tensioner seat belt system. Therefore, we recommend the system to be serviced by an authorized retailer of Genesis Branded products.

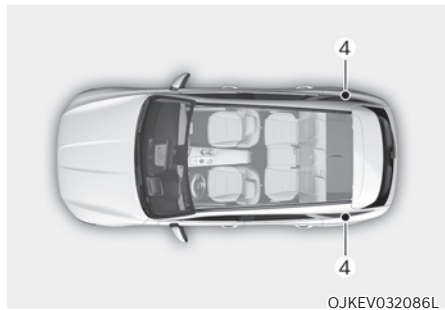
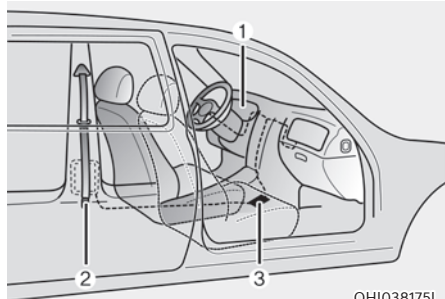

The Pre-Tensioner Seat Belt System consists mainly of the following components. Their locations are shown in the illustration above:

- (1) SRS air bag warning light
- (2) Retractor pre-tensioner
- (3) SRS control module
- (4) Rear Retractor pre-tensioner (if equipped)

**NOTICE**

The sensor that activates the SRS control module is connected with the pre-tensioner seat belts. The SRS air bag warning light on the instrument cluster will illuminate for approximately 3~6 seconds after the Start/Stop button is in the ON position, and then it should turn off.

If the pre-tensioner is not working properly, the warning light will illuminate even if the SRS air bag is not malfunctioning. If the warning light does not illuminate, stays illuminated or illuminates when the vehicle is being driven, we recommend the pre-tensioner seat belts and/or SRS control module be inspected by an authorized retailer of Genesis Branded products as soon as possible.

**i Information**

- Pre-tensioner seat belts may activate in certain frontal or side collisions or rollover situations (if equipped with rollover sensor).
- When the pre-tensioner seat belts are activated, a loud noise may be heard and fine dust, which may appear to be smoke, may be visible in the passenger compartment. These are normal operating conditions and are not hazardous.
- Although it is non-toxic, the fine dust may cause skin irritation and should not be inhaled for prolonged periods. Wash all exposed skin areas thoroughly after an accident in which the pre-tensioner seat belts were activated.

**Pre-Active Seat Belt (PSB) (if equipped)**

The purpose of the Pre-Active Seat Belt is to tighten the seat belt when a collision is sensed, during emergency braking, or when a loss of control is sensed.

**NOTICE**

**Pre-Active Seat Belt is a supplementary system. Pre-Active Seat Belt activates only when the passenger is wearing his/her seat belt.**

**Pre-Active Seat Belt operation**

In order to maximize the safety of the passenger, Pre-Active Seat Belt system operates as below.

- Full retraction
  - The seat belt is tightened when:
    - Emergency braking situation occurs
    - Losing control of the vehicle
    - The vehicle detects a collision
    - The vehicle detects driving on a frozen road
    - Driving on a rough road with severe impact
    - Unstable rolling of the vehicle occurs
- Slack removal
  - Tightens a loose seat belt if vehicle speed is over 15 km/h (9 mph).
- Belt parking
  - Tightens a loose seat belt when the seat belt is unfastened.

### Warning message

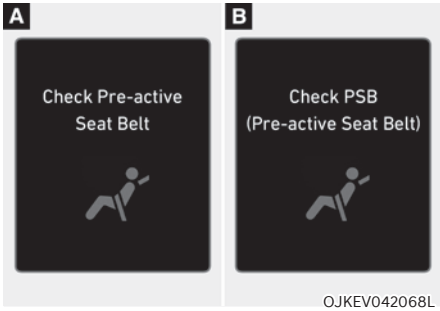

#### Check Pre-active Seat Belt/Check PSB (Pre-active Seat Belt)

The Pre-Active Seat Belt warning message will appear if there is a problem with your Pre-Active Seat Belt.

We recommend that the system be inspected by an authorized retailer of Genesis Branded products if the warning message comes on while the vehicle is in motion. When the Pre-Active Seat Belt warning message disappears, the master warning light (⚠) will illuminate.

### Additional seat belt safety precautions

#### Seat belt use during pregnancy

The seat belt should always be used during pregnancy. The best way to protect your unborn child is to protect yourself by always wearing the seat belt.

Pregnant women should always wear a lap-shoulder seat belt. Place the shoulder belt across your chest, routed between your breasts and away from your neck. Place the lap belt below your belly so that it fits **SNUGLY** across your hips and pelvic bone, under the rounded part of the belly.



#### WARNING

- **Pregnant women and patients are more vulnerable to any impacts on the abdomen during an abrupt stop or accident. If you are in an accident while pregnant, we recommend you consult your doctor.**
- **To reduce the risk of serious injury or death to an unborn child during an accident, pregnant women should NEVER place the lap portion of the seat belt above or over the area of the abdomen where the unborn child is located.**

#### Seat belt use and children

##### Infant and small children

Most countries have Child Restraint System laws which require children to travel in approved Child Restraint System devices, including booster seats. The age at which seat belts can be used instead of Child Restraint System differs among countries, so you should be aware of the specific requirements in your country, and where you are travelling. Infant and Child Restraint System must be properly placed and installed in a rear seat.

For more information refer to the “Child Restraint Systems” section in this chapter.

**WARNING**

**ALWAYS** properly restrain infants and small children in a Child Restraint System appropriate for the child's height and weight.

**To reduce the risk of serious injury or death to a child and other passengers, NEVER hold a child in your lap or arms when the vehicle is moving. The violent forces created during an accident will tear the child from your arms and throw the child against the interior of the vehicle.**

Small children are best protected from injury in an accident when properly restrained in the rear seat by a Child Restraint System that meets the requirements of the Safety Standards of your country. Before buying any Child Restraint System, make sure that it has a label certifying that it meets Safety Standard of your country.

The Child Restraint System must be appropriate for your child's height and weight. Check the label on the Child Restraint System for this information. Refer to "Child Restraint Systems" section in this chapter.

**Larger children**

Children under age 13 and who are too large for a booster seat should always occupy the rear seat and use the available lap/shoulder belts. A seat belt should lie across the upper thighs and be snug across the shoulder and chest to restrain the child safely. Check belt fit periodically. A child's squirming could put the belt out of position. In the event of an accident, children are afforded the best safety restrained by a proper Child Restraint System in the rear seats.

If a larger child over age 13 must be seated in the front seat, the child must be securely restrained by the available lap/shoulder belt and the seat should be placed in the rearmost position.

If the shoulder belt portion slightly touches the child's neck or face, try placing the child closer to the center of the vehicle. If the shoulder belt still touches their face or neck, they need to be returned to an appropriate booster seat in the rear seat.

**WARNING**

- **Always make sure larger children's seat belts are worn and properly adjusted.**
- **NEVER allow the shoulder belt to contact the child's neck or face.**
- **Do not allow more than one child to use a single seat belt.**

***Seat belt use and injured people***

A seat belt should be used when an injured person is being transported. Consult a physician for specific recommendations.



### ***One person per belt***

Two people (including children) should never attempt to use a single seat belt. This could increase the severity of injuries in case of an accident.

### ***Do not lie down***

Sitting in a reclined position when the vehicle is in motion can be dangerous. Even when buckled up, the protections of your restraint system (seat belts and/or air bags) is greatly reduced by reclining your seatback.

Seat belts must be snug against your hips and chest to work properly.

During an accident, you could be thrown into the seat belt, causing neck or other injuries.

The more the seat back is reclined, the greater the chance for the passenger's hips to slide under the lap belt or the passenger's neck to strike the shoulder belt.



### **WARNING**

- **NEVER ride with a reclined seatback when the vehicle is moving.**
- **Riding with a reclined seatback increases your chance of serious or fatal injuries in the event of a collision or sudden stop.**
- **Driver and passengers should always sit well back in their seats with the seatbacks upright and should be belted properly.**

### **Care of seat belts**

Seat belt systems should never be disassembled or modified. In addition, care should be taken to assure that seat belts and belt hardware are not damaged by seat hinges, doors or other abuse.

### ***Periodic inspection***

All seat belts should be inspected periodically for wear or damage of any kind. Any damaged parts should be replaced as soon as possible.

### ***Keep belts clean and dry***

Seat belts should be kept clean and dry. If belts become dirty, they can be cleaned by using a mild soap solution and warm water. Bleach, dye, strong detergents or abrasives should not be used because they may damage and weaken the fabric.

### ***When to replace seat belts***

The entire seat belt assembly or assemblies should be replaced if the vehicle has been involved in an accident. This should be done even if no damage is visible. We recommend that you consult an authorized retailer of Genesis Branded products.

## CHILD RESTRAINT SYSTEM (CRS)

### Our recommendation: Children always in the rear



#### WARNING

**Always properly restrain children in the vehicle. Children of all ages are safer when riding in the rear seats. Never place a rearward-facing Child Restraint System on the front passenger seat, unless the air bag is deactivated.**

Children under age 13 should always ride in the rear seats and must always be properly restrained to minimize the risk of injury in an accident, sudden stop or sudden maneuver.

According to accident statistics, children are safer when properly restrained in the rear seats than in the front seat. Children too large for a Child Restraint System must use the seat belts provided.

Most countries have regulations which require children to travel in approved Child Restraint Systems.

The laws governing the age or height/weight restrictions at which seat belts can be used instead of Child Restraint System differs among countries, so you should be aware of the specific requirements in your country, and where you are travelling.

Child Restraint Systems must be properly installed in the vehicle seat. Always use a commercially available Child Restraint System that meets the requirements of your country.

### *Child Restraint System (CRS)*

Infants and younger children must be restrained in an appropriate rearward-facing or forward-facing CRS that has first been properly secured to the seat of the vehicle. Read and comply with the instructions for installation and use provided by the manufacturer of the Child Restraint System.



#### WARNING

- **Always follow the Child Restraint System manufacturer's instructions for installation and use.**
- **Always properly restrain your child in the Child Restraint System.**
- **Do not use an infant carrier or a child safety seat that "hooks" over a seatback, it may not provide adequate protection in an accident.**
- **After an accident, we recommend a retailer of Genesis Branded products to check the Child Restraint System, seat belts, ISOFIX anchorages and top-tether anchorages.**

## Selecting a Child Restraint System (CRS)

When selecting a Child Restraint System for your child, always:

- Make sure the Child Restraint System has a label certifying that it meets applicable Safety Standards of your country.

A Child Restraint System may only be installed if it was approved in accordance with the requirements of ECE-R44 or ECE-R129.

- Select a Child Restraint System based on your child's height and weight. The required label or the instructions for use typically provide this information.
- Select a Child Restraint System that fits the vehicle seating position where it will be used.
- Read and comply with the warnings and instructions for installation and use provided with the Child Restraint System.

### **Child Restraint System types**

There are three main types of Child Restraint Systems: rearward-facing, forward-facing and booster Child Restraint Systems.

They are classified according to the child's age, height and weight.



OJKEV0310421

### **Rearward-facing Child Restraint System**

A rearward-facing Child Restraint System provides restraint with the seating surface against the back of the child. The harness system holds the child in place, and in an accident, acts to keep the child positioned in the Child Restraint Systems and reduce the stress to the fragile neck and spinal cord.

All children under the age of one year must always ride in a rearward-facing Child Restraint System. There are different types of rearward-facing Child Restraint Systems: infant-only Child Restraint Systems can only be used rearward-facing. Convertible and 3-in-1 Child Restraint Systems typically have higher height and weight limits for the rearward-facing position, allowing you to keep your child rearward-facing for a longer period of time.

Keep using Child Restraint Systems in the rearward-facing position as long as children fit within the height and weight limits allowed by the Child Restraint System's manufacturer.



### **Forward-facing Child Restraint System**

A forward-facing Child Restraint System provides restraint for the child's body with a harness. Keep children in a forward-facing Child Restraint System with a harness until they reach the top height or weight limit allowed by your Child Restraint System's manufacturer.

Once your child outgrows the forward-facing Child Restraint System, your child is ready for a booster seat.

### **Booster seats**

A booster seat is a Child Restraint System designed to improve the fit of the vehicle's seat belt system. A booster seat positions the seat belt so that it fits properly over the stronger parts of your child's body. Keep your children in booster seats until they are big enough to fit in a seat belt properly.

For a seat belt to fit properly, the lap belt must lie comfortable across the upper thighs, not the stomach. The shoulder belt should lie comfortable across the shoulder and chest and not across the neck or face. Children under age 13 must always be properly restrained to minimize the risk of injury in an accident, sudden stop or sudden maneuver.

## Installing a Child Restraint System (CRS)



### WARNING

**Before installing your Child Restraint System always:**

**Read and follow the instructions provided by the manufacturer of the Child Restraint System.**

**Failure to follow all warnings and instructions could increase the risk of the SERIOUS INJURY or DEATH if an accident occurs.**



### WARNING

**If the vehicle headrest prevents proper installation of a Child Restraint System, the headrest of the respective seating position shall be readjusted or entirely removed.**

After selecting a proper Child Restraint System for your child and checking that the Child Restraint System fits properly on the seating position, there are three general steps for a proper installation:

- **Properly secure the Child Restraint System to the vehicle.** All Child Restraint Systems must be secured to the vehicle with the lap belt or lap part of a lap/shoulder belt or with the ISOFIX top-tether and/or ISOFIX anchorage and/or with the support leg.

- **Make sure the Child Restraint System is firmly secured.** After installing a Child Restraint System to the vehicle, push and pull the seat forward and from side-to-side to verify that it is securely attached to the seat. A Child Restraint System secured with a seat belt should be installed as firmly as possible. However, some side-to-side movement can be expected.

When installing a Child Restraint System, adjust the vehicle seat and seatback (up and down, forward and rearward) so that your child fits in the Child Restraint System in a comfortable manner.

- **Secure the child in the Child Restraint System.** Make sure the child is properly strapped in the Child Restraint System according to the Child Restraint System manufacturer's instructions.



### CAUTION

**A Child Restraint System in a closed vehicle can become very hot. To prevent burns, check the seating surface and buckles before placing your child in the Child Restraint System.**

### **Suitability of each seating position for belted & ISOFIX Child Restraint Systems according to UN regulation (for Europe)**

(Information for vehicle users and CRS manufacturers)

- Yes: Suitable for fitment of the designated category of CRS
- No: Not suitable for fitment of the designated category of CRS
- “-”: Not applicable
- The table is based on left-hand drive vehicle. Except for the front passenger seat, the table is valid for right-hand drive vehicle. For right-hand drive vehicle front passenger seat, please use information for the seating position number 3.

CRS categories		Seating positions					
		1,2	3		4	5	6
			Airbag ON	Airbag OFF			
Universal belted CRS	All mass groups	-	No	Yes <sup>1)</sup> (F, R)	Yes <sup>2)</sup> (F, R)	Yes <sup>3)</sup> (F, R)	Yes <sup>2)</sup> (F, R)
i-size CRS	ISOFIX CRF : F2, F2X, R1, R2	-	No	No	Yes (F, R)	No	Yes (F, R)
Carry-cot (ISOFIX lateral facing CRS)	ISOFIX CRF: L1, L2	-	No	No	No	No	No
ISOFIX infant* CRS (* : ISOFIX baby CRS)	ISOFIX CRF : R1	-	No	No	Yes (R)	No	Yes (R)
ISOFIX toddler CRS - small	ISOFIX CRF : F2, F2X, R2, R2X	-	No	No	Yes (F, R)	No	Yes (F, R)
ISOFIX toddler CRS - large* (* : not booster seats)	ISOFIX CRF : F3,R3	-	No	No	Yes (F, R)	No	Yes (F, R)
Booster Seat - reduced Width	ISO CRF : B2	-	Yes	No	Yes	No	Yes
Booster Seat - full Width	ISO CRF : B3	-	Yes	No	Yes	No	Yes

\* **F** : Forward facing, **R** : Rearward facing

Note<sup>1)</sup>: To install Universal CRS, 1<sup>st</sup> row passenger seat height should be at its highest position.

Note<sup>2)</sup>: To install Universal CRS to 2<sup>nd</sup> row outer seating positions, 1<sup>st</sup> row seat should be adjust forward properly.

Note<sup>3)</sup>: Never install CRS with a support leg on 2<sup>nd</sup> row center seating position.

Seat number	Position in the vehicle	Seating positions
1	Front left	
2	Front center	
3	Front right	
4	Second row left	
5	Second row center	
6	Second row right	

OJKEV032087L

- \* If the vehicle headrest prevents proper installation of a CRS, the headrest of the seating position shall be readjusted or entirely removed.
- \* Never place a rearward facing Child Restraint System on the front passenger seat, unless the air bag is deactivated.

**Recommended CRS for Vehicle according to UN regulations**

(Information for use by vehicle users and CRS manufacturers)

Mass group	Name	Manufacturer	Type of Fixation	ECE Approval Number
Group 0+	BABY-SAFE 2 i-SIZE and BABY-SAFE i-SIZE BASE	Britax Römer	ISOFIX with support leg rearward facing	R129/00 - E1 - 000008
Group I	Duo Plus	Britax Römer	ISOFIX and top-tether	R44/04 - E1 - 04301133
Group II	KidFix II R	Britax Römer	ISOFIX and vehicle belt, using CRS lap belt guide	R44/04 - E1 - 04301304
Group III	Junior III	Graco	Vehicle belt	R44/04 - E11 - 03.44.165

**CRS Manufacturer information**

Britax Römer: <http://www.britax.com>

Graco: <http://www.gracobaby.com>

### **Suitability of each seating position for belted & ISOFIX Child Restraint Systems according to UN regulations (except Europe)**

(Information for vehicle users and CRS manufacturers)

- Yes: Suitable for fitment of the designated category of CRS
- No: Not suitable for fitment of the designated category of CRS
- “-”: Not applicable
- The table is based on left-hand drive vehicle. Except for the front passenger seat, the table is valid for right-hand drive vehicle. For right-hand drive vehicle front passenger seat, please use information for the seating position number 3.

CRS categories		Seating positions					
		1,2	3		4	5	6
			Airbag ON	Airbag OFF			
Universal belted CRS	All mass groups	-	No	Yes <sup>1)</sup> (F)	Yes <sup>2)</sup> (F, R)	Yes <sup>3)</sup> (F, R)	Yes <sup>2)</sup> (F, R)
i-size CRS	ISOFIX CRF : F2, F2X, R1, R2	-	No	No	No	No	No
Carry-cot (ISOFIX lateral facing CRS)	ISOFIX CRF: L1, L2	-	No	No	No	No	No
ISOFIX infant* CRS (* : ISOFIX baby CRS)	ISOFIX CRF : R1	-	No	No	Yes (R)	No	Yes (R)
ISOFIX toddler CRS - small	ISOFIX CRF : F2, F2X, R2, R2X	-	No	No	Yes (F, R)	No	Yes (F, R)
ISOFIX toddler CRS - large* (* : not booster seats)	ISOFIX CRF : F3, R3	-	No	No	Yes (F, R)	No	Yes (F, R)
Booster Seat - reduced Width	ISO CRF : B2	-	Yes	No	Yes	No	Yes
Booster Seat - full Width	ISO CRF : B3	-	Yes	No	Yes	No	Yes

\* **F** : Forward facing, **R** : Rearward facing

Note<sup>1)</sup>: To install Universal CRS, 1<sup>st</sup> row passenger seat height should be at its highest position.

Note<sup>2)</sup>: To install Universal CRS to 2<sup>nd</sup> row outer seating positions, 1<sup>st</sup> row seat should be adjust forward properly.

Note<sup>3)</sup>: Never install CRS with a support leg on 2<sup>nd</sup> row center seating position.



Seat number	Position in the vehicle	Seating positions
1	Front left	
2	Front center	
3	Front right	
4	Second row left	
5	Second row center	
6	Second row right	

OJKEV032087L

- \* If the vehicle headrest prevents proper installation of a CRS, the headrest of the seating position shall be readjusted or entirely removed.
- \* Never place a rearward facing Child Restraint System on the front passenger seat, unless the air bag is deactivated.

### ***ISOFIX anchorage and top-tether anchorage (ISOFIX anchorage system) for children***

The ISOFIX system holds a Child Restraint System during driving and in an accident. This system is designed to make installation of the Child Restraint System easier and reduce the possibility of improperly installing your Child Restraint System. The ISOFIX system uses anchors in the vehicle and attachments on the Child Restraint System. The ISOFIX system eliminates the need to use seat belts to secure the Child Restraint System to the rear seats. ISOFIX anchorages are metal bars built into the vehicle. There are two lower anchors for each ISOFIX seating position that will accommodate a Child Restraint System with lower attachments.

To use the ISOFIX system in your vehicle, you must have a Child Restraint System with ISOFIX attachments.

The Child Restraint System manufacturer will provide you with instructions on how to use the Child Restraint System with its attachments for the ISOFIX anchorages.

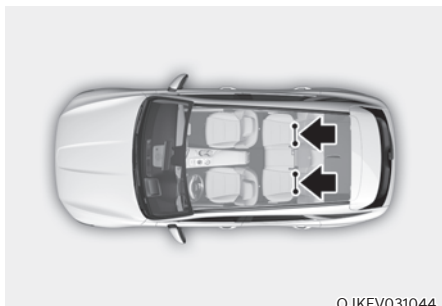

ISOFIX anchorages have been provided in the left and right outboard rear seating positions. Their locations are shown in the illustration.

### **⚠ WARNING**

**Do not attempt to install a Child Restraint System using ISOFIX anchorages in the rear center seating position. There are no ISOFIX anchorages provided for this seat. Using the outboard seat anchorages, for the CRS installation on the rear center seating position, can damage the anchorages.**

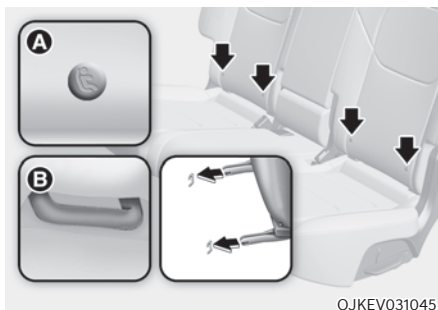

[A]: ISOFIX Anchorage Position Indicator

(Type A- , Type B- )

[B]: ISOFIX Anchorage

ISOFIX anchorages are located between the seatback and the seat cushion of the rear seat left and right outboard seating positions, indicated by the symbols.

### ***Securing a Child Restraint System with the “ISOFIX Anchorage System”***

To install an i-Size or ISOFIX-compatible Child Restraint System in either of the rear outboard seating positions:

1. Move the seat belt buckle away from the ISOFIX anchorages.
2. Move any other objects away from the anchorages that could prevent a secure connection between the Child Restraint System and the ISOFIX anchorages.

3. Place the Child Restraint System on the vehicle seat, then attach the seat to the ISOFIX anchorages according to the instructions provided by the Child Restraint System manufacturer.
4. Follow the instructions of the Child Restraint System's manufacturer for proper installation and connection of the ISOFIX attachments on the Child Restraint System to the ISOFIX anchorages.



**WARNING**

Take the following precautions when using the ISOFIX system:

- Read and follow all installation instructions provided with your Child Restraint System.
- To prevent the child from reaching and taking hold of unretracted seat belts, buckle all unused rear seat belts and retract the seat belt webbing behind the child. Children can be strangled if a shoulder belt becomes wrapped around their neck and the seat belt tightens.
- NEVER attach more than one Child Restraint System to a single anchorage. This could cause the anchor or attachment to come loose or break.
- Always have the ISOFIX system inspected by your dealer after an accident. An accident can damage the ISOFIX system and may not properly secure the Child Restraint System.

**Securing a Child Restraint System seat with “Top-tether Anchorage” system**



Top-tether anchorages for Child Restraint Systems are located on the rear of the seatbacks.



1. Route the Child Restraint System top-tether strap over the seatback. Placing the top tether strap, follow the instructions of the Child Restraint System manufacturer.
2. Connect the top-tether strap to the top-tether anchorage, then tighten the top-tether strap according to the instructions of your Child Restraint System's manufacturer to firmly attach the Child Restraint System to the seat.

**WARNING**

Take the following precautions when installing the top-tether:

- Read and follow all installation instructions provided with your Child Restraint System.
- NEVER attach more than one Child Restraint System to a single ISOFIX top-tether anchorage. This could cause the anchorage or attachment to come loose or break.
- Do not attach the top-tether to anything other than the correct top-tether anchorage. It may not work properly if attached to something else.
- Child Restraint System anchorages are designed to withstand only those loads imposed by correctly fitted Child Restraint System.

Do not use them for adult seat belts, harnesses, or for attaching other items or equipment to the vehicle.

**Securing a Child Restraint System with a lap/shoulder belt**

When not using the ISOFIX system, all Child Restraint Systems must be secured to a rear seat with the lap part of a lap/shoulder belt.

**Installing a Child Restraint System with a lap/shoulder belt**

To install a Child Restraint System on the rear seats, do the following:

1. Place the Child Restraint System on a rear seat and route the lap/shoulder belt around or through the Child Restraint System, following the Child Restraint System manufacturer's instructions. Make sure the seat belt webbing is not twisted.



2. Fasten the lap/shoulder belt latch into the buckle. Listen for the distinct “click” sound.

**i Information**

**Position the release button so that it is easy to access in case of an emergency.**



- 3. Remove as much slack from the belt as possible by pushing down on the Child Restraint System while feeding the shoulder belt back into the retractor.
- 4. Push and pull on the Child Restraint System to confirm that the seat belt is holding it firmly in place.

If your Child Restraint System manufacturer recommends the use of a top-tether with the lap/shoulder belt, see page 3-44.

To remove the Child Restraint System, press the release button on the buckle and then pull the lap/shoulder belt out of the Child Restraint System and allow the seat belt to retract fully.

**⚠ WARNING**

**If a child restraint is installed in the second row center seat, move the second row seat far back as possible, to minimize contact with the front center air bag (if equipped with front center air bag).**

## AIR BAG - SUPPLEMENTAL RESTRAINT SYSTEM

Left-hand drive



1. Driver's front air bag
2. Passenger's front air bag
3. Side air bag
4. Curtain air bag
5. Driver's knee air bag
6. Front center side air bag
7. Front passenger air bag ON/OFF switch (if equipped)

Right-hand drive

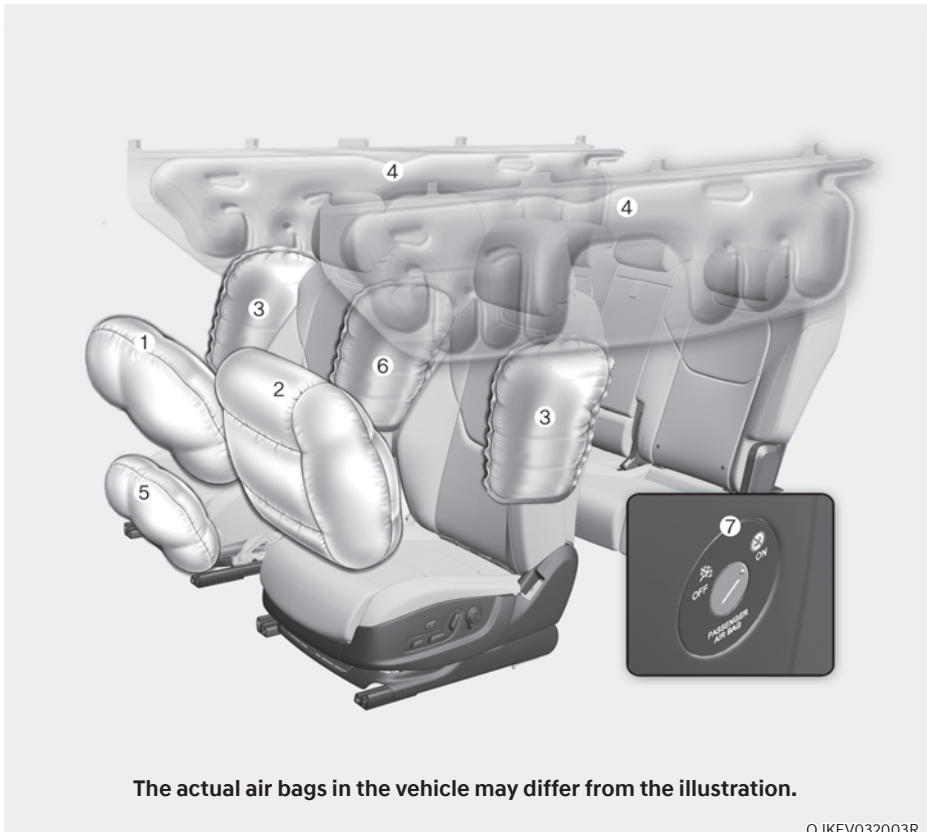

- 1. Driver's front air bag
- 2. Passenger's front air bag
- 3. Side air bag
- 4. Curtain air bag
- 5. Driver's knee air bag
- 6. Front center side air bag
- 7. Front passenger air bag ON/OFF switch (if equipped)

The vehicles are equipped with a Supplemental Air Bag System for the driver's seat and front passenger's seats.

The front air bags are designed to supplement the three-point seat belts. For these air bags to provide protection, the seat belts must be worn at all times when driving.

You can be severely injured or killed in an accident if you are not wearing a seat belt. Air bags are designed to supplement seat belts, but do not replace them. Also, air bags are not designed to deploy in every collision. In some accidents, the seat belts are the only restraint protecting you.



## **WARNING**

### **AIR BAG SAFETY PRECAUTIONS**

**ALWAYS** use seat belts and Child Restraint Systems - every trip, every time, everyone! Even with air bags, you can be seriously injured or killed in a collision if you are improperly belted or not wearing your seat belt when the air bag inflates.

**NEVER** place a child in any Child Restraint System or booster seat in the front passenger seat, unless the air bag is deactivated.

An inflating air bag could forcefully strike the infant or child causing serious or fatal injuries.

**ABC - Always Buckle Children under age 13 in the back seat. It is the safest place for children of any age to ride. If a child age 13 or older must be seated in the front seat, he or she must be properly belted and the seat should be moved as far back as possible.**

All occupants should sit upright with the seatback in an upright position, centered on the seat cushion with their seat belt on, legs comfortably extended and their feet on the floor until the vehicle is parked and the vehicle is turned off. If an occupant is out of position during an accident, the rapidly deploying air bag may forcefully contact the occupant causing serious or fatal injuries.

You and your passengers should never sit or lean unnecessarily close to the air bags or lean against the door or center console.

Move your seat as far back as possible from front air bags, while still maintaining control of the vehicle.



### Where are the air bags? Driver's and passenger's front air bags

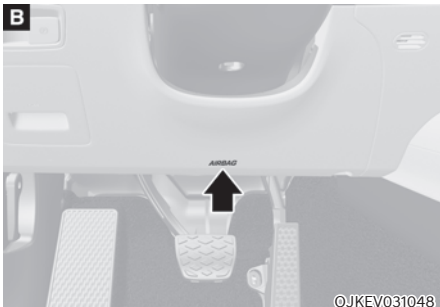
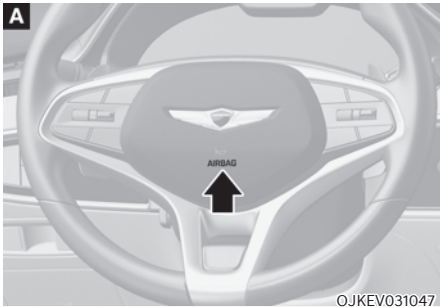

[A]: Driver's front air bag, [B]: Driver's knee air bag, [C]: Passenger's front air bag

Your vehicle is equipped with a Supplemental Restraint System (SRS) and lap/shoulder belts at both the driver and passenger seating positions.

The SRS consists of air bags which are located in the center of the steering wheel, in the driver's side lower crash pad below the steering wheel, and the passenger's side front panel pad above the glove box.

The air bags are labeled with the letters "AIR BAG" embossed on the pad covers.

The purpose of the SRS is to provide the vehicle's driver and front passengers with additional protection than that offered by the seat belt system alone in case of a frontal impact of sufficient severity.



### WARNING

To reduce the risk of serious injury or death from inflating front air bags, take the following precautions:

- **Seat belts must be worn at all times to help keep occupants positioned properly.**
- **Move your seat as far back as possible from front air bags, while still maintaining control of the vehicle.**
- **Never lean against the door or center console.**
- **Do not allow the front passenger to place their feet or legs on the dashboard.**
- **No objects (such as crash pad cover, mobile phone holder, cup holder, perfume or stickers) should be placed over or near the air bag modules on the steering wheel, instrument panel, windshield glass, and the front passenger's panel above the glove box. Such objects could cause harm if the vehicle is in a crash severe enough to cause the air bags to deploy.**
- **Do not attach any objects on the front windshield and inside mirror.**



### Passenger's front air bag ON/OFF switch (if equipped)

The purpose of the switch is to disable the passenger's front air bag in order to transport occupants who are at increased risk for air bag-related injury due to age, size, or medical condition.



To deactivate the passenger's front air bag:

Insert the key or a similar rigid device into the passenger's front air bag ON/OFF switch and turn it to the OFF position. The passenger air bag OFF indicator (⊗) will illuminate and stay on until the passenger's front air bag is reactivated.



To reactivate the passenger's front air bag:

Insert the key or a similar rigid device into the passenger's front air bag ON/OFF switch and turn it to the ON position. The passenger air bag ON indicator (⊗) will illuminate.

### **i** Information

**The passenger's front air bag ON/OFF indicator generally illuminates for about 4 seconds after the Start/Stop button is in the ON position. But, if the Start/Stop button is pressed to the ON position within 3 minutes after the vehicle was turned off, the indicator will not illuminate.**

**⚠ WARNING**

Never allow an adult passenger to ride in the front passenger seat when the passenger air bag OFF indicator is illuminated. During a collision, the air bag will not inflate if the indicator is illuminated. Turn on the passenger's front air bag or have your passenger move to the rear seat.

**⚠ WARNING**

If the passenger's front air bag ON/OFF switch malfunctions, the following conditions may occur:

- The air bag warning light (🚨) on the instrument cluster will illuminate.
- The passenger air bag OFF indicator (🚫) will not illuminate and the ON indicator (🚗) will come on. The passenger's front air bag will inflate in a frontal impact even though the passenger's front air bag ON/OFF switch is set to the OFF position.
- We recommend that an authorized retailer of Genesis Branded products inspect the passenger's front air bag ON/OFF switch and the SRS air bag system as soon as possible.

**Side air bags and front center side air bag (if equipped)**

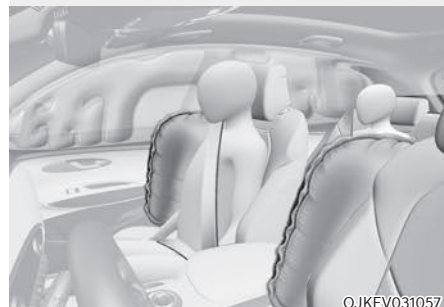
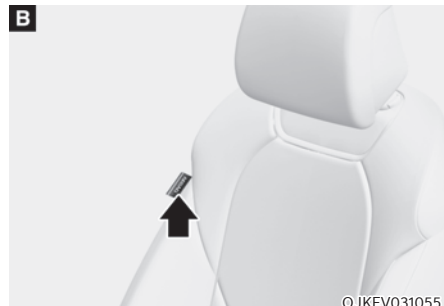
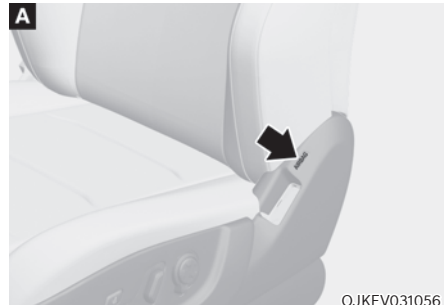

[A]: Side air bag,  
[B]: Front center side air bag (Driver's seat)

Your vehicle is equipped with a side air bag in each front seat. Additionally, a front center side air bag is provided in the inboard side of the driver seatback. The purpose of the air bag is to provide the vehicle's additional protection than that offered by the seat belt alone.

The side air bags and front center side air bag are designed to deploy during certain side impact collisions, depending on the crash severity.

For vehicles equipped with a rollover sensor the front center side air bag, side and/or curtain air bags and pretensioners on both sides of the vehicle may deploy if a rollover or possible rollover is detected.

The side air bags and front center side air bag are not designed to deploy in all side impact or rollover situations.



### **WARNING**

To reduce the risk of serious injury or death from an inflating side air bag and front center side air bag, take the following precautions:

- **Seat belts must be worn at all times to help keep occupants positioned properly.**
  - **Do not allow passengers to lean their heads or bodies onto doors, put their arms on the doors, stretch their arms out of the window, or place objects between the doors and seats.**
  - **Hold the steering wheel at the 9 o'clock and 3 o'clock positions, to minimize the risk of injuries to your hands and arms.**
  - **Do not use any accessory seat covers. This could reduce or prevent the effectiveness of the system.**
  - **Do not hang objects over the air bags. In an accident it may cause vehicle damage or personal injury especially when air bag is inflated.**
- **Do not place any objects over the air bag or between the air bag and yourself. Also, do not attach any objects around the area the air bag inflates such as the door, side door glass, front and rear pillar.**
  - **Do not place any objects between the door and the seat. They may become dangerous projectiles if the side air bag inflates.**
  - **Do not install any accessories on the side or near the side air bags.**
  - **Do not cause impact to the doors when the Start/Stop button is in the ON or START position as this may cause the side air bags to inflate.**
  - **If the seat or seat cover is damaged, we recommend that the system be serviced by an authorized retailer of Genesis Branded products.**

### Curtain air bags

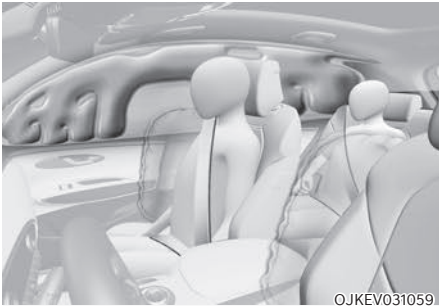
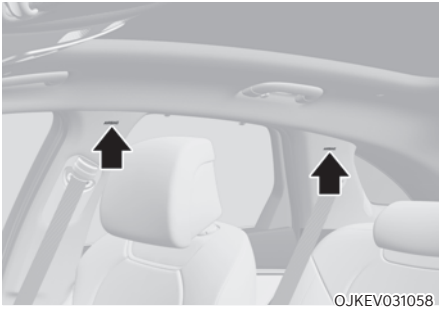

Curtain air bags are located along both sides of the roof rails above the front and rear doors.

They are designed to help protect the heads of the front seat occupants and the rear outboard seat occupants in certain side impact collisions.

The curtain air bags are designed to deploy during certain side impact collisions, depending on the crash severity.

For vehicles equipped with a rollover sensor the side and/or curtain air bags and pre-tensioners on both sides of the vehicle may deploy if a rollover or possible rollover is detected.

The curtain air bags are not designed to deploy in all side impact or rollover situations.

#### **WARNING**

To reduce the risk of serious injury or death from an inflating curtain air bag, take the following precautions:

- All seat occupants must wear seat belts at all times to help keep occupants positioned properly.
- Properly secure Child Restraint System as far away from the door as possible.
- Do not place any objects over the air bag. Also, do not attach any objects around the area the air bag inflates such as the door, side door glass, front and rear pillar, roof side rail.
- Do not hang other objects, especially hard or breakable objects.  
In an accident, it may cause vehicle damage or personal injury.
- Do not allow passengers to lean their heads or bodies onto doors, put their arms on the doors, stretch their arms out of the window, or place objects between the doors and seats.
- Do not attempt to open or repair the side curtain air bags yourself. If necessary, we recommend that the air bag be inspected by an authorized retailer of Genesis Branded products.

## How does the air bag system operate?

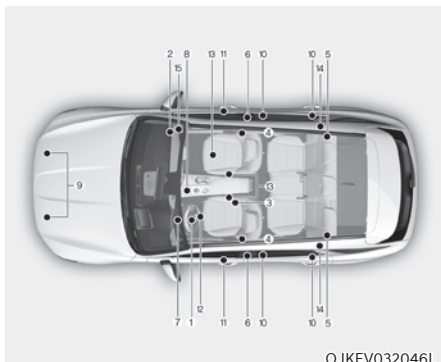

OJKEV032046L

The SRS consists of the following components:

- (1) Driver's front air bag module
- (2) Passenger's front air bag module
- (3) Front center side air bag module (if equipped)
- (4) Side air bag modules
- (5) Curtain air bag modules
- (6) Front retractor pre-tensioner
- (7) Air bag warning light
- (8) SRS control module (SRSCM) / Rollover sensor (if equipped)
- (9) Front impact sensors
- (10) Side impact sensors (acceleration)
- (11) Side impact sensors (pressure)
- (12) Driver's knee air bag module
- (13) Driver's and front passenger's seat belt buckle sensors
- (14) Rear retractor pre-tensioner (if equipped)
- (15) Front passenger's air bag ON/OFF switch (if equipped)

### **i** Information

**Front passenger's air bag ON/OFF lamp is located on the overhead console.**

The SRSCM (Supplemental Restraint System Control Module) continually monitors all SRS components while the Start/Stop button is ON to determine if a crash impact is severe enough to require air bag deployment or pre-tensioner seat belt deployment.



### SRS warning light

The SRS (Supplemental Restraint System) air bag warning light on the instrument panel displays the air bag symbol depicted in the illustration. The system checks the air bag electrical system for malfunctions. The light indicates that there is a potential problem with your air bag system, which could include your side and/or curtain air bags used for rollover protection (if equipped with rollover sensor).



**WARNING**

**If your SRS malfunctions, the air bag may not inflate properly during an accident, increasing the risk of serious injury or death.**

**If any of the following conditions occur, your SRS is malfunctioning:**

- **The light does not turn on for approximately three to six seconds when the Start/Stop button is in the ON position.**
- **The light stays on after illuminating for approximately three to six seconds.**
- **The light comes on while the vehicle is in motion.**
- **The light blinks when the vehicle is running.**

**We recommend that an authorized retailer of Genesis Branded products inspect the SRS as soon as possible if any of these conditions occur.**

During a moderate to severe frontal collision, sensors will detect the vehicle's rapid deceleration. If the rate of deceleration is high enough, the control unit will inflate the front air bags, at the time and with the force needed.

The front air bags help protect the driver and front passenger by responding to frontal impacts in which seat belts alone cannot provide adequate restraint. The side air bags help provide protection in certain side impacts or rollover accidents by supporting the side upper body area.

- Air bags are activated (able to inflate if necessary) only when the Start/Stop button is in the ON or START position, and it can be activated within about 3 minutes after the vehicle is turned off.
- Air bags inflate in the event of certain frontal or side collisions to help protect the occupants from serious physical injury.
- Generally, air bags are designed to inflate based upon the severity of a collision, its direction, or etc. These two factors determine whether the sensors produce an electronic deployment/inflation signal.
- The front air bags will completely inflate and deflate in an instant. It is virtually impossible for you to see the air bags inflate during an accident. It is much more likely that you will simply see the deflated air bags hanging out of their storage compartments after the collision.

- In addition to inflating in serious side collisions, vehicles equipped with a rollover sensor, side and/or curtain air bags and front center side air bag will inflate if the sensing system detects a rollover.

When a rollover is detected, curtain air bags will remain inflated longer to help provide protection from ejection, especially when used in conjunction with the seat belts. (if equipped with a rollover sensor)

- To help provide protection, the air bags must inflate rapidly. The speed of air bag inflation is a consequence of extremely short time in which to inflate the air bag between the occupant and the vehicle structures before the occupant impacts those structures. This speed of inflation reduces the risk of serious or life-threatening injuries and is thus a necessary part of air bag design.

However, the rapid air bag inflation can also cause injuries which can include facial abrasions, bruises and broken bones because the inflation speed also causes the air bags to expand with a great deal of force.

- There are even circumstances under which contact with the air bag can cause fatal injuries, especially if the occupant is positioned excessively close to the air bag.

You can take steps to reduce the risk of being injured by an inflating air bag. The greatest risk is sitting too close to the air bag. An air bag needs space to inflate. It is recommended that drivers sit as far as possible between the center of the steering wheel and the chest while still maintaining control of the vehicle.



When the SRSCM detects a sufficiently severe impact to the front of the vehicle, it will automatically deploy the front air bags.



Upon deployment, tear seams molded directly into the pad covers will separate under pressure from the expansion of the air bags. Further opening of the covers allows full inflation of the air bags.

A fully inflated air bag, in combination with a properly worn seat belt, slows the driver's or the front passenger's forward motion, reducing the risk of head and chest injury.



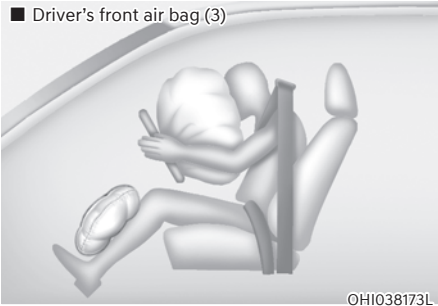

After complete inflation, the air bag immediately starts deflating, enabling the driver to maintain forward visibility and the ability to steer or operate other controls.

 **WARNING**

To prevent objects from becoming dangerous projectiles when the passenger's air bag inflates:

- Do not install or place any objects (drink holder, CD holder, stickers, etc.) on the front passenger's panel above the glove box where the passenger's air bag is located.
- Do not install a container of liquid air freshener near the instrument cluster or on the instrument panel surface.

## What to expect after an air bag inflates

After a frontal or side air bag inflates, it will deflate very quickly. Air bag inflation will not prevent the driver from seeing out of the windshield or being able to steer. Curtain air bags may remain partially inflated for some time after they deploy.

 **WARNING**

After an air bag inflates, take the following precautions:

- Open your windows and doors as soon as possible after impact to reduce prolonged exposure to the smoke and powder released by the inflating air bag.
- Do not touch the air bag storage area's internal components immediately after an air bag has inflated. The parts that come into contact with an inflating air bag may be very hot.
- Always wash exposed skin areas thoroughly with cold water and mild soap.
- We recommend that an authorized retailer of Genesis Branded products replace the air bag immediately after deployment. Air bags are designed to be used only once.

### Noise and smoke from inflating air bag

When the air bags inflate, they make a loud noise and may produce smoke and powder in the air inside of the vehicle. This is normal and is a result of the ignition of the air bag inflator. After the air bag inflates, you may feel substantial discomfort in breathing because of the contact of your chest with both the seat belt and the air bag, as well as from breathing the smoke and powder. The powder may aggravate asthma for some people. If you experience breathing problems after an air bag deployment, seek medical attention immediately.

Though the smoke and powder are nontoxic, they may cause irritation to the skin, eyes, nose, throat, etc. If this is the case, wash and rinse with cold water immediately and seek medical attention if the symptoms persist.

### Do not install a Child Restraint System on the front passenger seat



ORS031134

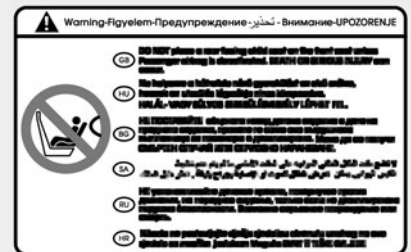

OHI038170L

Never install a Child Restraint System in the front passenger seat, unless the air bag is deactivated

### WARNING

**NEVER** use a rearward facing Child Restraint on a seat protected by an **ACTIVE AIRBAG** in front of it, **DEATH** or **SERIOUS INJURY** to the **CHILD** can occur.

## Why didn't my air bag go off in a collision?

There are certain types of accidents in which the air bag would not be expected to provide additional protection. These include rear impacts, second or third collisions in multiple impact accidents, as well as low speed impacts. Damage to the vehicle indicates a collision energy absorption, and is not an indicator of whether or not an air bag should have inflated.

## *Air bag collision sensors*



### **WARNING**

**To reduce the risk of an air bag deploying unexpectedly and causing serious injury or death:**

- **Do not hit or allow any objects to impact the locations where air bags or sensors are installed.**
- **Do not perform maintenance on or around the air bag sensors. If the location or angle of the sensors is altered, the air bags may deploy when they should not or may not deploy when they should.**
- **Installing bumper guards with non-genuine Genesis or non-equivalent parts may adversely affect the collision and airbag deployment performance.**

**To ensure correct function of the airbag system, we recommend to replace the bumper with genuine Genesis part or the equivalent (of the genuine part) specified for your vehicle.**

- **Press the Start/Stop button to the OFF or ACC position and wait for 3 minutes when the vehicle is being towed to prevent inadvertent air bag deployment.**
- **We recommend that all air bag repairs performed by an authorized retailer of Genesis Branded products.**

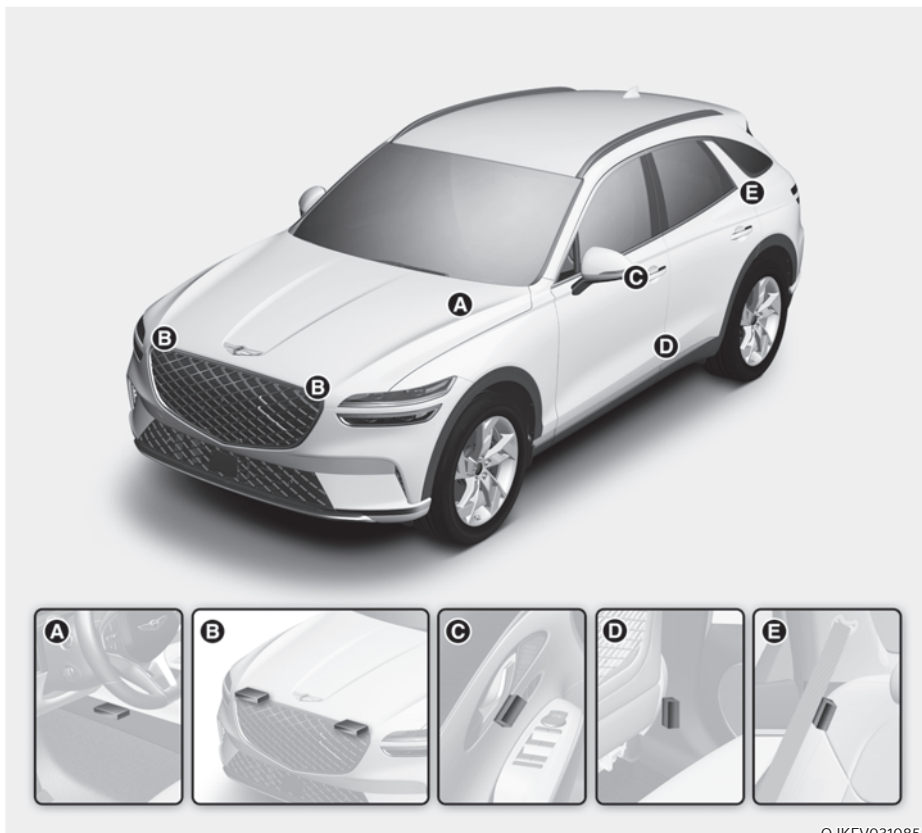

(A): SRS control module/Rollover sensor  
(B): Front impact sensor  
(C): Side impact sensor (Pressure)

(D): Side impact sensor (Acceleration)  
(E): Side impact sensor (Acceleration)

### Air bag inflation conditions



#### Front air bags

Front air bags are designed to inflate in a frontal collision depending on the severity of impact of the front collision.

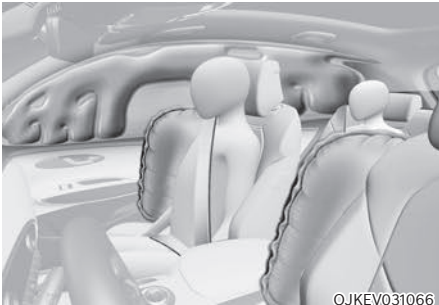

#### Side and curtain air bags and front center side air bag

Side and curtain air bags and the front center side air bag are designed to inflate when an impact is detected by side collision sensors depending on the severity of impact resulting from a side impact collision.

Although the driver's and front passenger's air bags are designed to inflate in frontal collisions, they also may inflate in other types of collisions if the front impact sensors detect a sufficient impact. Side and curtain air bags and the front center side air bag are designed to inflate in side impact collisions, but they may inflate in other collisions if the side impact sensors detect a sufficient impact.

Also, the side and curtain air bags and the front center side air bag are designed to inflate when a rollover is detected by a rollover sensor (if equipped with rollover sensor).

If the vehicle chassis is impacted by bumps or objects on unimproved roads, the air bags may deploy. Drive carefully on unimproved roads or on surfaces not designed for vehicle traffic to prevent unintended air bag deployment.

### Air bag non-inflation conditions



In certain low-speed collisions the air bags may not deploy. The air bags are designed not to deploy in such cases because they may not provide benefits beyond the protection of the seat belts.



Front air bags are not designed to inflate in rear collisions, because occupants are moved backward by the force of the impact. In this case, inflated air bags would not provide any additional benefit.



Front air bags may not inflate in side impact collisions, because occupants move in the direction of the collision, and thus in side impacts, front air bag deployment would not provide additional occupant protection.

However, side and curtain air bags and the front center side air bag may inflate depending on the severity of impact.

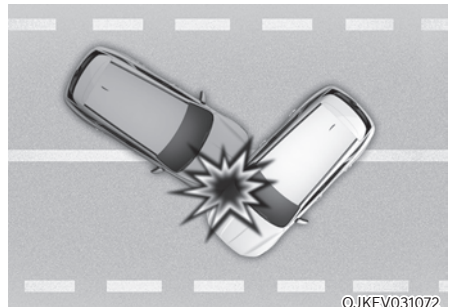

In an angled collision, the force of impact may direct the occupants in a direction where the air bags would not be able to provide any additional benefit, and thus the sensors may not deploy any air bags.



OJKEV031073

Just before impact, drivers often brake heavily. Such heavy braking lowers the front portion of the vehicle causing it to “ride” under a vehicle with a higher ground clearance. Air bags may not inflate in this “underride” situation because deceleration forces that are detected by sensors may be significantly reduced by such “underride” collisions.



OJKEV031075

Front air bags may not inflate in rollover accidents because front air bag deployment would not provide additional occupant protection.

**i** Information

**With rollover sensor**

The side and curtain air bags and the front center side air bag may inflate in a rollover situation, when it is detected by the rollover sensor.

**i** Information

**Without rollover sensor**

The side and/or curtain air bags and the front center side air bag may inflate when the vehicle is rolled over by a side impact collision, if the vehicle is equipped with side and/or curtain air bags.



OJKEV031074

Air bags may not inflate if the vehicle collides with objects such as utility poles or trees, where the point of impact is concentrated and the collision energy is absorbed by the vehicle structure.

## SRS care

The SRS is virtually maintenance-free and there are no parts you can safely service by yourself. If the SRS air bag warning light does not illuminate when the Start/Stop button is in the ON position, or continuously remains on, we recommend that the system be immediately inspected by an authorized retailer of Genesis Branded products.

We recommend any work on the SRS system, such as removing, installing, repairing, or any work on the steering wheel, the front passenger's panel, front seats and roof rails be performed by an authorized retailer of Genesis Branded products. Improper handling of the SRS system may result in serious personal injuries.



## WARNING

To reduce the risk of serious injury or death take the following precautions:

- **Do not attempt to modify or disconnect the SRS components or wiring, including the addition of any kind of badges to the pad covers or modifications to the body structure.**
- **Do not place objects over or near the air bag modules on the steering wheel, instrument panel, and the front passenger's panel above the glove box.**
- **Clean the air bag pad covers with a soft cloth moistened with plain water. Solvents or cleaners could adversely affect the air bag covers and proper deployment of the system.**
- **We recommend that inflated air bags be replaced by an authorized retailer of Genesis Branded products.**
- **If components of the air bag system must be discarded, or if the vehicle must be scrapped, certain safety precautions must be observed. We recommend that you consult an authorized retailer of Genesis Branded products for the necessary information. Failure to follow these precautions could increase the risk of personal injury.**



### Additional safety precautions

**Passengers should not move out of or change seats while the vehicle is moving.** A passenger who is not wearing a seat belt during a crash or emergency stop can be thrown against the inside of the vehicle, against other occupants, or be ejected from the vehicle.

**Do not use any accessories on seat belts.** Devices claiming to improve occupant comfort or reposition the seat belt can reduce the protection provided by the seat belt and increase the chance of serious injury in a crash.

**Do not modify the front seats.** Modification of the front seats could interfere with the operation of the supplemental restraint system sensing components or side air bags.

**Do not place items under the front seats.** Placing items under the front seats could interfere with the operation of the supplemental restraint system sensing components and wiring harnesses.

**Do not cause impact to the doors.** Impact to the doors when the Start/Stop button is in the ON or START position may cause the air bags to inflate.

### *Adding equipment to or modifying your air bag equipped vehicle*

If you modify your vehicle by changing your vehicle's frame, bumper system, front end or side sheet metal or ride height, this may affect the operation of your vehicle's air bag system.

### Air bag warning labels



Air bag warning labels are attached to alert the passengers of potential risks of the air bag system.

Be sure to read all of the information about the air bags that are installed on your vehicle in this Owner's Manual.

## ACTIVE HOOD LIFT SYSTEM

The active hood lift system can reduce a risk of injury to pedestrians by raising the hood in certain accident situations. The active hood lift system has the additional deformation space under the hood, which is made available for subsequent head impact.

### System activation

#### *Prerequisite for activation*

The Start/Stop button is in the START position and the vehicle speed is between about 25 km/h (15.5 mph) and 50 km/h (31 mph).

#### **i** Information - Active hood lift system repair

- **If the active hood lift system has been activated, do not place the hood back by yourself. We recommend that the system be repaired by an authorized retailer of Genesis Branded products.**
- **If you change or repair the front bumper, we recommend that the system be checked by an authorized retailer of Genesis Branded products.**

### System activation

The active hood lift system is designed to work in a frontal collision depending on the intensity, speed or angles of impact of the front collision



The system may activate when:

- The vehicle falls in the gutter or from a high place
- An impact is detected by a frontal collision without pedestrians in front.
- Certain high-speed frontal or angled collision with a vehicle or barrier.

### System limitation

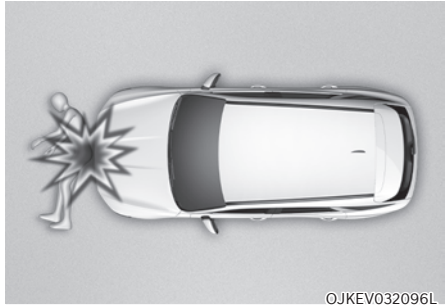
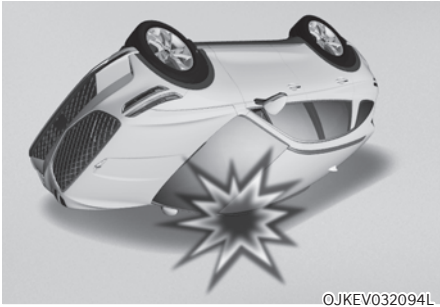
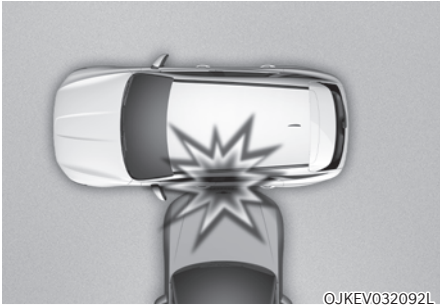

The system will not activate when:

- On side collisions, rear collision, and rollover accident. The vehicle can detect only frontal collision.
- The front bumper is damaged or modified.
- The vehicle is in an angled frontal collision with pedestrians.
- A pedestrian is laying on the road.
- A pedestrian has an object to absorb the shock such as a suit case, buggy or cart.

## System malfunction

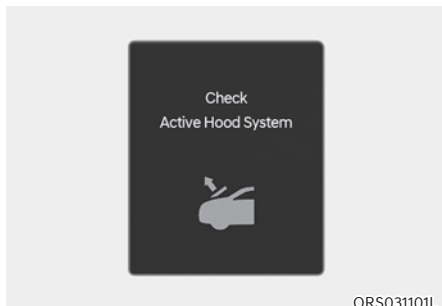

If there is a problem with the system a message will appear on the cluster LCD display.

This warning message means that the protection of pedestrians by the active hood lift system is not working properly.

If the warning message is displayed, we recommend that the system be checked as soon as possible by an authorized retailer of Genesis Branded products.

## *i* Information

- **Do not remove or change the components and the wiring of the active hood system.**
- **Do not change the front bumper or the body structure.**
- **Do not install or assemble any aftermarket accessory on the front bumper or cover.**
- **When replacing tires, make sure they are the same size as your original tires. If you drive with different tire or wheel sizes, the active hood lift system may not work normally.**

**The above situations may cause a malfunction of the active hood lift system.**

# 4. Instrument cluster

Instrument cluster .....	4-4
Instrument panel illumination .....	4-5
Gauges and meters .....	4-6
Speedometer .....	4-6
Power/charge gauge .....	4-6
State of charge (SOC) gauge for high voltage battery .....	4-7
Outside temperature gauge.....	4-8
Odometer .....	4-8
Distance to empty .....	4-9
Energy economy (for 12.3-inch 3D cluster).....	4-9
Reduction gear shift indicator .....	4-10
Regenerative braking level indicator.....	4-10
Warning and indicator lights .....	4-11
Ready indicator.....	4-11
Service warning light .....	4-11
Power down indicator light.....	4-11
Charging indicator light.....	4-12
High voltage battery level warning light .....	4-12
Seat belt warning light .....	4-12
Air bag warning light .....	4-12
Regenerative brake warning light.....	4-12
Parking brake & brake fluid warning light .....	4-13
Anti-lock Brake System (ABS) warning light .....	4-14
Electronic Brake Force Distribution (EBD) system warning light .....	4-14
Motor Driven Power Steering (MDPS) warning light.....	4-15
Master warning light.....	4-15
Electronic Parking Brake (EPB) warning light .....	4-15
Low tire pressure warning light .....	4-16
Forward safety warning light .....	4-16
Lane safety indicator light.....	4-17
Intelligent Front-Lighting System warning light .....	4-17
LED headlight warning light.....	4-17
All Wheel Drive (AWD)warning light .....	4-17
Icy road warning light.....	4-18
Electronic Stability Control (ESC) indicator light.....	4-18

Electronic Stability Control (ESC) OFF indicator light.....	4-18
Immobilizer indicator light.....	4-19
Turn signal indicator light.....	4-19
High beam indicator light .....	4-19
Low beam indicator light .....	4-19
Light ON indicator light.....	4-20
Rear fog indicator light.....	4-20
Intelligent Front-Lighting System indicator light .....	4-20
High Beam Assist indicator light.....	4-20
AUTO HOLD indicator light .....	4-20
LCD display messages .....	4-21
Shift to P .....	4-21
Vehicle is in N. Press START button and shift to P (and turn vehicle off).....	4-21
Low key battery .....	4-21
Press START button while turning wheel .....	4-21
Low washer fluid .....	4-21
Check steering wheel lock system .....	4-21
Press brake pedal to start vehicle .....	4-21
Key not in vehicle .....	4-21
Key not detected.....	4-21
Press START button again .....	4-21
Press START button with key.....	4-22
Check BRAKE SWITCH fuse .....	4-22
Shift to P to start vehicle .....	4-22
Battery discharging due to external/additional electrical devices .....	4-22
Door, Hood, Tailgate open indicator .....	4-22
Low tire pressure .....	4-23
Lights .....	4-23
Wiper .....	4-23
Check haptic steering wheel system.....	4-24
Check headlight.....	4-24
Check turn signal .....	4-24
Check headlamp LED .....	4-24
Shift to P to charge .....	4-24
Remaining time.....	4-24
Unplug vehicle to start .....	4-25

# 4. Instrument cluster

Charging door open.....	4-25
Charging stopped. Check the charger/Charging interrupted. Check the charger .....	4-25
Charging stopped. Check the cable connection/Charging interrupted. Please check the cable connection.....	4-26
Check regenerative brakes.....	4-26
Low EV battery/Low battery .....	4-26
Charge immediately. Power limited .....	4-27
Power limited due to low EV battery temperature. Charge battery.....	4-27
EV Battery Overheated! Stop vehicle/Battery overheated! Stop safely.....	4-28
Power limited .....	4-28
Stop vehicle and check power supply/Stop safely and check power supply .....	4-29
Check virtual engine sound system.....	4-29
Check electric vehicle system .....	4-29
LCD display.....	4-30
LCD display control .....	4-30
View modes .....	4-30
Driving Assist view .....	4-31
Turn By Turn (TBT) view .....	4-31
Utility view.....	4-32
Option menu.....	4-35
Service messages .....	4-36
3D cluster/3D effect (for 12.3-inch 3D cluster) .....	4-36
Head-up display.....	4-36
Driver Assistance settings .....	4-36
Speed unit .....	4-37
3D instrument cluster (for 12.3-inch 3D cluster) .....	4-37
3D cluster setting.....	4-37
Recommendations to optimize the 3D effect .....	4-37
Vehicle settings (infotainment system).....	4-40
Setting your vehicle .....	4-40

## INSTRUMENT CLUSTER

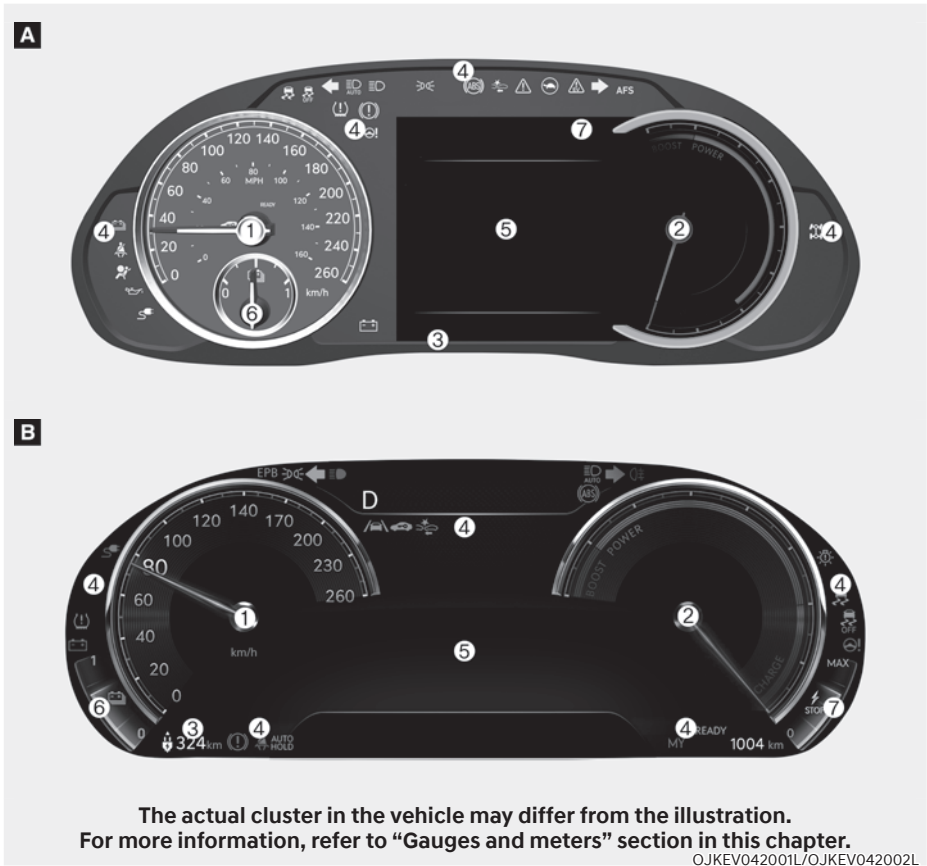

1. Speedometer
2. Power/Charge gauge
3. Distance to empty
4. Warning indicator light
5. LCD display
6. Battery SOC (State of Charge) gauge
7. Smart recuperation system



## Instrument cluster control Instrument panel illumination (if equipped)

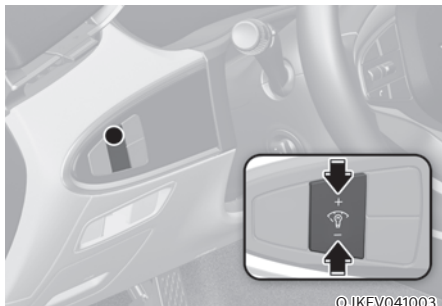

©JKEV041003

When the vehicle's position lights or headlamps are on, press the illumination control switch to adjust the brightness of the instrument panel illumination.

When pressing the illumination control switch, the interior switch illumination intensity is also adjusted.



### **WARNING**

**Never adjust the instrument cluster while driving. This could result in loss of control and lead to an accident that may cause death, serious injury, or vehicle damage.**

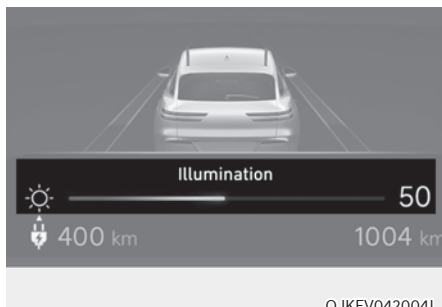

- The brightness of the instrument panel illumination is displayed.
- If the brightness reaches the maximum or minimum level, a chime will sound.

### Gauges and meters

#### Speedometer



OJKEV041026

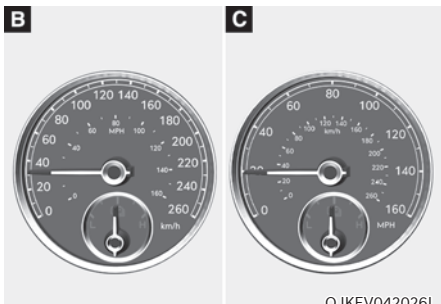

OJKEV042026L

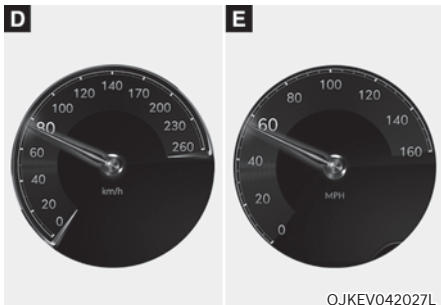

OJKEV042027L

The speedometer indicates the speed of the vehicle and is calibrated in kilometers per hour (km/h) and/or miles per hour (MPH).

#### Power/charge gauge



OJKEV041012



OJKEV041013

The Power/Charge Gauge shows the energy consumption and recovery status of the electric motor.

- **POWER:**  
It shows discharging status of the electric motor when vehicle is accelerating or driving on a uphill road. The more electric energy is discharged (used), the higher the gauge level.
- **CHARGE:**  
It shows the charging status of the electric motor when vehicle is decelerating or driving on a downhill road (being charged by the regenerative brakes). The more electric energy is charged, the higher the gauge level.

### State of charge (SOC) gauge for high voltage battery

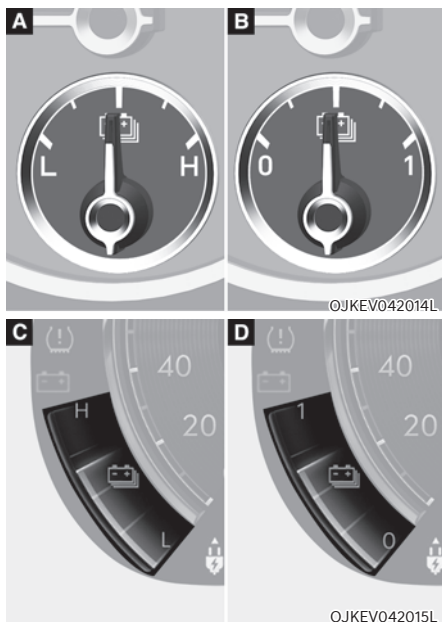

- The SOC gauge shows the charging status of the high voltage battery.
- The 'L'(or '0') on the indicator indicates that there is not enough energy in the high voltage battery. 'H' (or '1') indicates that the driving battery is fully charged.
- When driving on highways or motorways, make sure to check in advance if the driving battery is charged enough.

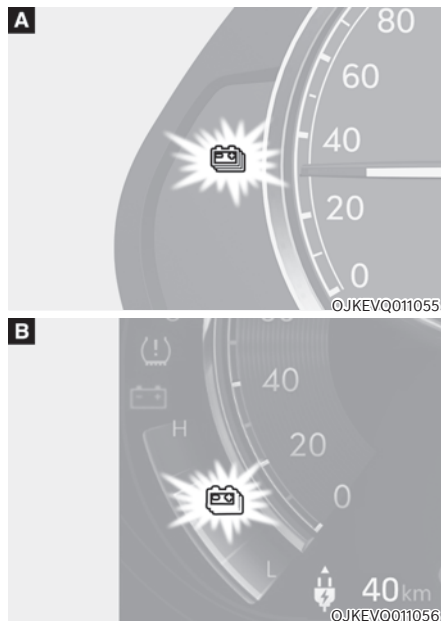

1. When the remaining battery is lower than 10 % on the SOC gauge, the warning light (🔋⚡) turns ON to alert you of the battery level.
2. When the warning light (🔋⚡) turns ON, the vehicle can drive an additional 20~40 km (12~25 miles) depending on the driving speed, heater/air conditioner, weather, driving style, and other factors. Charging is required.

### NOTICE

**When the high voltage battery level is low, the power down indicator light illuminates and the vehicle power is limited. Charge the battery immediately since your vehicle may not be driven, or may roll back on a slope with the indicator light ON.**

### Outside temperature gauge



Gauge accuracy for outside air temperature is 1°C (1°F).

Note that the temperature indicated on the LCD display may not change as quickly as the outside temperature (there may be a slight delay before the temperature changes.)

You can change the temperature unit from the Settings menu in the infotainment system screen. Select:

- General Settings → Unit → Temperature Unit → °C/°F

For detailed information, scan the QR code in a separately supplied simple manual.

Both the temperature unit on the cluster LCD display and climate control screen will change.

### Odometer

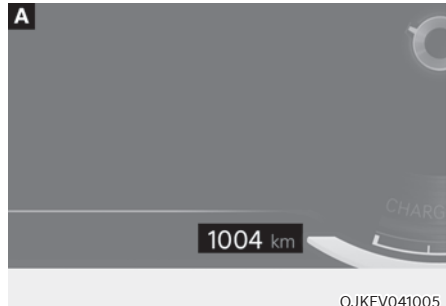

The odometer indicates the total distance that the vehicle has been driven and should be used to determine when periodic maintenance should be performed.

## Distance to empty



- The distance to empty is the estimated distance the vehicle can be driven with the remaining electric energy.
- The distance to empty varies depend on which drive mode is selected among ECO/COMFORT/SPORT mode.

For more detail information, refer to 'Distance to empty' in chapter 1.

## *i* Information

- If the vehicle is not on level ground or the battery power has been interrupted, the distance to empty function may not operate correctly.
- The distance to empty may differ from the actual driving distance as it is an estimate of the available driving distance.
- The distance to empty may vary significantly based on driving conditions, driving habits, ambient temperature, weather, varying terrain and condition of the vehicle.

## Energy economy (for 12.3-inch 3D cluster)

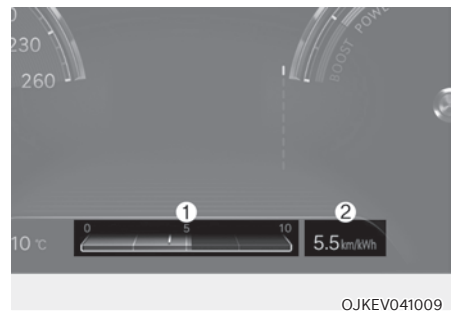

The instant energy economy (1) and average energy economy (2) is displayed at the bottom of the cluster.

**Automatic reset**

To automatically reset the average energy economy, select between 'After Ignition' or 'After Recharging' from the Settings menu in the infotainment system screen.

**i Information**

For 8-inch instrument cluster, you can check the energy economy in the Utility view on the cluster.

Refer to "View Modes" section in chapter 4.

**Reduction gear shift indicator**

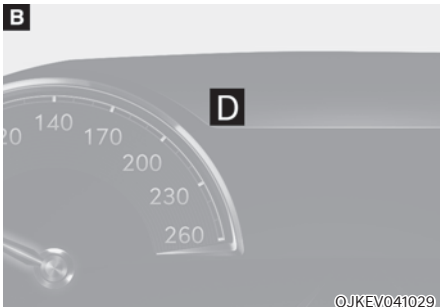
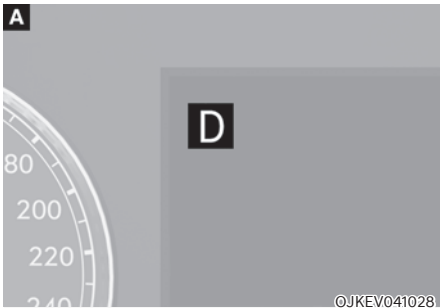

The indicator displays which gear is selected.

**Regenerative braking level indicator**



The regenerative brake indicates the level of the regenerative braking that you set. And it also indicates Smart regenerative system's operation status. For more details, refer to "Regenerative Braking System" in chapter 6.

## Warning and indicator lights

### Information

**Make sure that all warning lights are OFF after starting the vehicle. If any light is still ON, this indicates a situation that needs attention.**

#### *Ready indicator*

**READY**

#### **This indicator illuminates:**

When the vehicle is ready to be driven.

- ON: Normal driving is possible.
- OFF: Normal driving is not possible, or a problem has occurred.
- Blinking: Emergency driving.

When the ready indicator goes OFF or blinks, there is a problem with the system. In this case, we recommend that you have your vehicle inspected by an authorized retailer of Genesis Branded products.

#### *Service warning light*



#### **This warning light illuminates:**

- When the START/STOP button is in the ON position.
  - It illuminates for approximately 3 seconds and then goes off.
- When there is a problem with related parts of the electric vehicle control system, such as sensors, etc.

When the warning light illuminates while driving, or does not go OFF after starting the vehicle, we recommend that you have your vehicle inspected by an authorized retailer of Genesis Branded products.

#### *Power down indicator light*



#### **This indicator light illuminates:**

- For the safety of high-powered components of electric vehicles, the power is limited due to the following reasons. (Unless both Service Warning Light and Power Down Indicator Light illuminate at the same time, it is not a failure.)
  - The high voltage battery level is too low or voltage is decreasing
  - The temperature of the high voltage battery is too high or too low
  - The temperature of the motor is high

#### **NOTICE**

- **Do not accelerate or start the vehicle suddenly when the power down indicator light is ON.**
- **When the power is limited for the safety of the high-powered parts of an electric vehicle, the power down indicator light illuminates. Your vehicle may not be driven, or may roll back on a slope with the indicator light ON due to the limitation of vehicle power.**

### **Charging indicator light**



**This warning light illuminates:**

- When charging the high voltage battery.

### **High voltage battery level warning light**



**This warning light illuminates:**

- When the high voltage battery level is low.
- When the warning light turns ON, charge the battery immediately.

### **Seat belt warning light**



This warning light informs the driver that the seat belt is not fastened.

For more details, refer to “Seat Belts” section in chapter 3.

### **Air bag warning light**



**This warning light illuminates:**

- When you set the Start/Stop button to the ON position.
  - The air bag warning light illuminates for about 6 seconds and then turns off when all checks have been performed.
- The air bag warning light will remain illuminated if there is a malfunction with the Safety Restraint System (SRS) air bag operation.

If this occurs, we recommend that you have the vehicle inspected by an authorized retailer of Genesis Branded products.

### **Regenerative brake warning light**



**This warning light illuminates:**

When the regenerative brake does not operate and the brake does not perform well. This causes the Brake Warning light (red) and Regenerative Brake Warning Light (yellow) to illuminate simultaneously.

In this case, drive safely and we recommend that you have your vehicle inspected by an authorized retailer of Genesis Branded products.

The operation of the brake pedal may be more difficult than normal and the braking distance can increase.



### ***Parking brake & brake fluid warning light***



#### **This warning light illuminates:**

- When you set the START/STOP button in the ON position.
  - It illuminates for approximately 3 seconds.
  - It remains on if the parking brake is applied.
- When the parking brake is applied.
- When the brake fluid level in the reservoir is low.
  - If the warning light illuminates with the parking brake released, it indicates the brake fluid level in the reservoir is low.
- When the regenerative brake does not operate.

#### **If the brake fluid level in the reservoir is low:**

1. Drive carefully to the nearest safe location and stop your vehicle.
2. With the motor stopped, check the brake fluid level immediately and add fluid as required (For more details, refer to “Brake Fluid” section in chapter 9). After adding brake fluid, check all brake components for fluid leaks. If a brake fluid leak is found, or if the warning light remains on, or if the brakes do not operate properly, do not drive the vehicle. We recommend that you have the vehicle inspected by an authorized retailer of Genesis Branded products.

#### **Dual-diagonal braking system**

Your vehicle is equipped with dual-diagonal braking system. This means you still have braking on two wheels even if one of the dual systems should fail.

With only one of the dual systems working, more than normal pedal travel and greater pedal pressure is required to stop the vehicle.

Also, the vehicle will not stop in as short a distance with only a portion of the brake system working.

If the brakes fail while you are driving, stop the vehicle as soon as it is safe to do so.



#### **WARNING**

#### **Parking Brake & Brake Fluid warning light**

**Driving the vehicle with a warning light ON is dangerous. If the Parking Brake & Brake Fluid warning light illuminates with the parking brake released, it indicates that the brake fluid level is low.**

**If this occurs, we recommend that you have the vehicle inspected by an authorized retailer of Genesis Branded products.**

**Anti-lock Brake System (ABS) warning light** 

This warning light illuminates:

- When you set the Start/Stop button to the ON position.
  - The ABS warning light illuminates for about 3 seconds and then goes off.
- Whenever there is a malfunction with the ABS.

Note that the hydraulic braking system will still be operational even if there is a malfunction with the ABS.

If this occurs, we recommend that you have the vehicle inspected by an authorized retailer of Genesis Branded products.

**Electronic Brake Force Distribution (EBD) system warning light** 



When the ABS warning and Parking Brake warning lights are on simultaneously, it may indicate a problem with the Electronic Brake Force Distribution system.

If this occurs, we recommend that you have the vehicle inspected by an authorized retailer of Genesis Branded products.

 **WARNING**

**Electronic Brake Force Distribution (EBD) system warning light**

**When both ABS and Parking Brake & Brake Fluid warning lights are on, the brake system will not work normally and you may experience an unexpected and dangerous situation during sudden braking.**

**If this occurs, avoid high speed driving and abrupt braking.**

**We recommend that you have the vehicle inspected by an authorized retailer of Genesis Branded products as soon as possible.**

**NOTICE**

**Electronic Brake Force Distribution (EBD) system warning light**

**When the ABS warning light is on or both ABS and Parking Brake & Brake Fluid warning lights are on, the speedometer, odometer, or tripmeter may not work. Also, the MDPS warning light may illuminate and the steering effort may increase or decrease.**

**If this occurs, we recommend that you have the vehicle inspected by an authorized retailer of Genesis Branded products as soon as possible.**

### Motor Driven Power Steering (MDPS) warning light



This warning light illuminates:

- When you set the Start/Stop button to the ON position.
  - The electric powering steering warning light illuminates for about 3 seconds and then goes off.
- Whenever there is a malfunction with the electric power steering.
 

If this occurs, we recommend that you have the vehicle inspected by an authorized retailer of Genesis Branded products.

### Master warning light



This warning light illuminates:

When there is a malfunction in operation in any of the following systems:

- Forward Collision-Avoidance Assist malfunction (if equipped)
- Forward Collision-Avoidance Assist radar blocked (if equipped)
- Blind-Spot Collision-Avoidance Assist malfunction (if equipped)
- Blind-Spot Collision-Avoidance Assist blocked (if equipped)
- LED headlamp malfunction (if equipped)
- High Beam Assist malfunction (if equipped)
- Smart Cruise Control malfunction (if equipped)
- Smart Cruise Control radar blocked (if equipped)
- Tire Pressure Monitoring System (TPMS) malfunction

To identify the details of the warning, look at the LCD display.

### Electronic Parking Brake (EPB) warning light

## EPB

This warning light illuminates:

- When you set the Start/Stop button to the ON position.
  - The EPB warning light illuminates for about 3 seconds and then goes off.
- Whenever there is a malfunction with EPB.
 

If this occurs, we recommend that you have the vehicle inspected by an authorized retailer of Genesis Branded products.

### Information

**The Electronic Parking Brake (EPB) warning light may illuminate when the Electronic Stability Control (ESC) indicator light comes on to indicate that ESC is not working properly. This does not indicate malfunction of EPB.**

### Low tire pressure warning light



This warning light illuminates:

- When you set the Start/Stop button to the ON position.
  - The low tire pressure warning light illuminates for approximately 3 seconds and then goes off.
- When one or more of your tires are significantly underinflated. (The location of the underinflated tires are displayed on the LCD display.)

For more details, refer to “Tire Pressure Monitoring System (TPMS)” section in chapter 8.

**This warning light remains ON after blinking for approximately 60 seconds, or repeatedly blinks ON and OFF in 3 second intervals:**

When there is a malfunction with the TPMS.

If this occurs, we recommend that you have the vehicle inspected by an authorized retailer of Genesis Branded products as soon as possible.

For more details, refer to “Tire Pressure Monitoring System (TPMS)” section in chapter 8.

### WARNING

Safe Stopping

- **The TPMS cannot alert you to severe and sudden tire damage caused by external factors.**
- **If you notice any vehicle instability, immediately take your foot off the accelerator pedal, apply the brakes gradually with light force, and slowly move to a safe position off the road.**

### Forward safety warning light (if equipped)



This warning light illuminates:

- When you set the Start/Stop button to the ON position.
  - The Forward Safety warning light illuminates for approximately 3 seconds and then goes off.
- If Forward Safety is selected ‘Off’, Forward Collision-Avoidance Assist will turn off. The warning light will illuminate on the cluster.
- Forward Collision-Avoidance Assist will turn off when ESC is turned off by pressing and holding the ESC OFF button. The warning light will illuminate on the cluster.
- Whenever there is a malfunction with Forward Collision-Avoidance Assist.

If this occurs, we recommend that you have the vehicle inspected by an authorized retailer of Genesis Branded products.

For more details, refer to “Forward Collision-Avoidance Assist (FCA)” section in chapter 7.

**Lane safety indicator light  
(if equipped)****This indicator light illuminates:**

- Green: When Lane Keeping Assist operating conditions are satisfied.
- Gray: When Lane Keeping Assist operating conditions are not satisfied.
- Yellow: Whenever there is a malfunction with Lane Keeping Assist. If this occurs, we recommend that you have the vehicle inspected by an authorized retailer of Genesis Branded products.

For more details, refer to “Lane Keeping Assist (LKA)” section in chapter 7.

**Intelligent Front-Lighting  
System warning light (if  
equipped)****AFS****This warning light illuminates:**

- When you set the Start/Stop button to the ON position.
  - The Intelligent Front-Lighting System warning light illuminates for approximately 3 seconds and then goes off.
- Whenever there is a malfunction with Intelligent Front-Lighting System.

If this occurs, drive your vehicle to the nearest safe location, and turn the vehicle off and restart the vehicle. If the warning light remains on, we recommend that you have the vehicle inspected by an authorized retailer of Genesis Branded products.

**LED headlight warning light  
(if equipped)****This warning light illuminates:**

- When you set the Start/Stop button to the ON position.
  - The LED headlight warning light illuminates for approximately 3 seconds and then goes off.
- Whenever there is a malfunction with the LED headlight. If this occurs, we recommend that you have the vehicle inspected by an authorized retailer of Genesis Branded products.

**This warning light blinks:**

Whenever there is a malfunction with a LED headlight related part.

If this occurs, we recommend that you have the vehicle inspected by an authorized retailer of Genesis Branded products.

**NOTICE**

**Continuous driving with the LED Headlight warning light on or blinking can reduce LED headlight life.**

**All Wheel Drive (AWD)  
warning light (if equipped)****This warning light illuminates:**

Whenever there is a malfunction with the AWD system.

If this occurs, we recommend that you have the vehicle inspected by an authorized retailer of Genesis Branded products.

For more details, refer to "All Wheel Drive (AWD)" section in chapter 6.

**Icy road warning light  
(if equipped)**



This warning light is to warn the driver the road may be icy.

When the temperature on the outside temperature gauge is approximately below 4°C (40°F), the Icy Road warning light and Outside Temperature Gauge blinks and then illuminates. Also, the warning chime sounds 1 time.

You can activate or deactivate Icy Road Warning function from the Settings menu in the infotainment system screen. Select:

- Setup → Vehicle Settings → Cluster → Content Selection → Icy Road Warning

For detailed information, scan the QR code in a separately supplied simple manual.

***i* Information**

**If the Icy Road warning light appears while driving, you should drive more attentively and safely refraining from over-speeding, rapid acceleration, sudden braking or sharp turning, etc.**

**Electronic Stability Control  
(ESC) indicator light**



**This indicator light illuminates:**

- When you set the Start/Stop button to the ON position.
  - The Electronic Stability Control indicator light illuminates for about 3 seconds and then goes off.
- Whenever there is a malfunction with ESC system.

If this occurs, we recommend that you have the vehicle inspected by an authorized retailer of Genesis Branded products.

**This indicator light blinks:**

While ESC is operating.

For more details, refer to “Electronic Stability Control (ESC)” section in chapter 6.

**Electronic Stability Control  
(ESC) OFF indicator light**



**This indicator light illuminates:**

- When you set the Start/Stop button to the ON position.
  - The ESC OFF indicator light illuminates for approximately 3 seconds and then goes off.
- When you deactivate ESC system by pressing the ESC OFF button.

For more details, refer to “Electronic Stability Control (ESC)” section in chapter 6.

**Immobilizer indicator light****This indicator light illuminates for up to 30 seconds:**

When the vehicle detects the smart key in the vehicle with the Start/Stop button in the ACC or ON position.

- Once the smart key is detected, you can start the vehicle.
- The indicator light goes off after starting the vehicle.

**This indicator light blinks for a few seconds:**

When the smart key is not in the vehicle.

- If the smart key is not detected, you cannot start the vehicle.

**This indicator light illuminates for 2 seconds and goes off:**

If the smart key is in the vehicle and the Start/Stop button is ON, but the vehicle cannot detect the smart key.

If this occurs, we recommend that you have the vehicle inspected by an authorized retailer of Genesis Branded products.

**This indicator light blinks:**

Whenever there is a malfunction with the immobilizer system.

If this occurs, we recommend that you have the vehicle inspected by an authorized retailer of Genesis Branded products.

**Turn signal indicator light****This indicator light blinks:**

When you operate the turn signal indicator stalk.

If any of the following occur, there may be a malfunction with the turn signal system.

- The turn signal indicator light illuminates but does not blink
- The turn signal indicator light blinks rapidly
- The turn signal indicator light does not illuminate at all

If any of these conditions occur, we recommend that you have the vehicle inspected by an authorized retailer of Genesis Branded products.

**High beam indicator light****This indicator light illuminates:**

- When the headlamps are on and in the high beam position
- When the turn signal lever is pulled into the Flash-to-Pass position.

**Low beam indicator light****This indicator light illuminates:**

When the headlamps are on.

**Light ON indicator light**



**This indicator light illuminates:**

When the position lamps or headlamps are on.

**Rear fog indicator light**



**This indicator light illuminates:**

When the rear fog lamps are on.

**Intelligent Front-Lighting System indicator light (if equipped)**



**This indicator light illuminates:**

When the high-beam is on with the light switch in the AUTO position.

- White: When Intelligent Front-Lighting system is ready to operate.
- Green: When Intelligent Front-Lighting system is operating.

If your vehicle detect oncoming or preceding vehicles, the Intelligent Front-Lighting system partially turns off the high beam LED lamps.

For more details, refer to “Intelligent Front-Lighting System” section in chapter 5.

**High Beam Assist indicator light (if equipped)**



**This indicator light illuminates:**

When the high-beam is on with the light switch in the AUTO position.

- White: When High Beam Assist is ready to operate.
- Green: When High Beam Assist is operating.

If your vehicle detects oncoming or preceding vehicles, High Beam Assist will switch the high beam to low beam automatically.

For more details, refer to “High Beam Assist (HBA)” section in chapter 5.

**AUTO HOLD indicator light**



**This indicator light illuminates:**

- Green: When you activate Auto Hold by pressing the AUTO HOLD switch.
- Gray: When you stop the vehicle completely by depressing the brake pedal with Auto Hold activated.
- Yellow: Whenever there is a malfunction with the Auto Hold function.

If this occurs, we recommend that you have the vehicle inspected by an authorized retailer of Genesis Branded products.

For more details, refer to “Electronic Parking Brake (EPB)” section in chapter 6.



## **LCD display messages**

### ***Shift to P***

This message is displayed if you try to turn off the vehicle without the gear in the P (Park) position.

If this occurs, the Start/Stop button turns to the ACC position.

### ***Vehicle is in N. Press START button and shift to P (and turn vehicle off)***

This message is displayed if you try to turn off the vehicle with the gear in N (Neutral).

To turn off the vehicle:

1. Press the Start/Stop button. The button will change to the ON position.
2. Press the P button to shift to P (Park).
3. Press the Start/Stop button again, then the vehicle will turn off.

### ***Low key battery***

This message is displayed if the battery of the smart key is discharged while changing the Start/Stop button to the OFF position.

### ***Press START button while turning wheel (if equipped)***

This message is displayed if the steering wheel does not unlock normally when the Start/Stop button is pressed.

You should press the Start/Stop button while turning the steering wheel right and left.

### ***Low washer fluid (if equipped)***

This message is displayed if the washer fluid level in the reservoir is nearly empty. Have the washer fluid reservoir refilled.

### ***Check steering wheel lock system (if equipped)***

This message is displayed if the steering wheel does not lock normally while the Start/Stop button is pressed to the OFF position.

### ***Press brake pedal to start vehicle***

This message is displayed if the Start/Stop button changes to the ACC position twice by pressing the button repeatedly without depressing the brake pedal.

You can start the vehicle by depressing the brake pedal and then pressing the Start/Stop button.

### ***Key not in vehicle***

This message is displayed if the smart key is not in the vehicle when you leave the vehicle with the Start/Stop button in the ON or Start position.

Always turn off the vehicle before leaving your vehicle.

### ***Key not detected***

This message is displayed if the smart key is not detected when you press the Start/Stop button.

### ***Press START button again***

This message is displayed if you were unable to start the vehicle when the Start/Stop button was pressed.

If this occurs, attempt to start the vehicle by pressing the Start/Stop button again.

If the warning message appears each time you press the Start/Stop button, we recommend that you have the vehicle inspected by an authorized retailer of Genesis Branded products.

**Press START button with key (if equipped)**

This message is displayed if you press the Start/Stop button while the warning message “Key not detected” is displayed. At this time, the immobilizer indicator light blinks.

**Check BRAKE SWITCH fuse**

This message is displayed if the brake switch fuse is disconnected.

You need to replace the fuse with a new one before starting the vehicle.

If that is not possible, you can start the vehicle by pressing the Start/Stop button for 10 seconds in the ACC position.

**Shift to P to start vehicle**

This message is displayed if you try to start the vehicle in any other position except P (Park).

***i* Information**

**You can start the vehicle with the gear in N (Neutral). But, for your safety, we recommend that you start the vehicle with the gear shifted to P (Park).**

**Battery discharging due to external/additional electrical devices**

This message is displayed if the 12 V battery voltage is weak due to any non-factory electrical accessories (for examples, dashboard camera) while parking. Be careful that the battery is not discharged.

If the message appears after removing the non-factory electrical accessories, we recommend that you have the vehicle inspected by an authorized retailer of Genesis Branded products.

**Door, Hood, Tailgate open indicator**

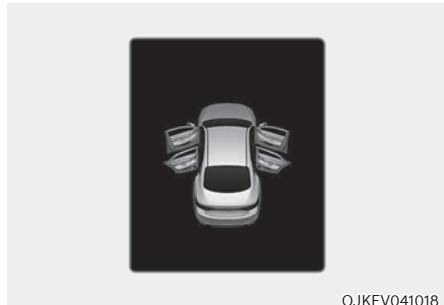

This warning is displayed if any door or hood or tailgate is left open. The warning will indicate which door is open in the display.



**CAUTION**

**Before driving the vehicle, you should confirm that the door, hood and tailgate are fully closed.**

## Low tire pressure



OJKEV042020L

This warning message is displayed if the tire pressure is low. The corresponding tire on the vehicle will be illuminated.

For more details, refer to “Tire Pressure Monitoring System (TPMS)” section in chapter 8.

## Lights

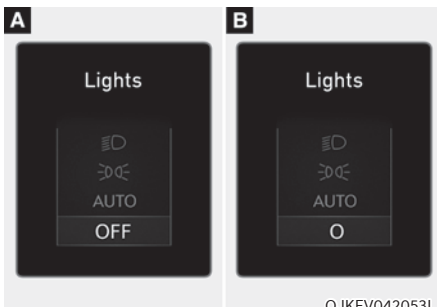

OJKEV042053L

This indicator displays which exterior light is selected using the lighting control.

You can activate or deactivate Wiper/Lights display function from the Settings menu in the infotainment system screen. Select:

- Setup → Vehicle Settings → Cluster → Content Selection → Wiper/Lights Display

For detailed information, scan the QR code in a separately supplied simple manual.

## Wiper

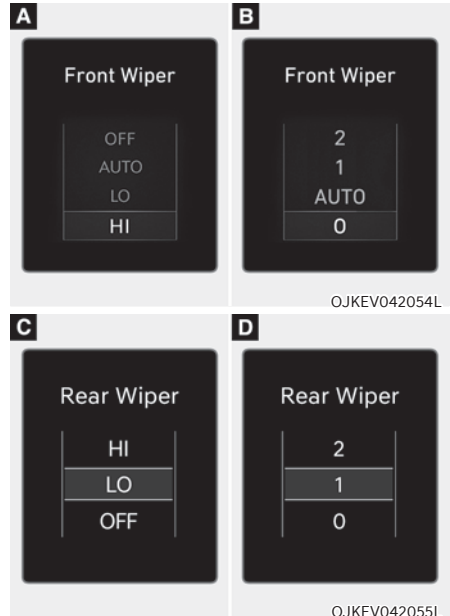

OJKEV042055L

[A], [B]: Front wiper, [C], [D]: Rear wiper

This indicator displays which wiper speed is selected using the wiper control.

You can activate or deactivate Wiper/Lights display function from the Settings menu in the infotainment system screen. Select:

- Setup → Vehicle Settings → Cluster → Content Selection → Wiper/Lights Display

For detailed information, scan the QR code in a separately supplied simple manual.

**Check haptic steering wheel system (if equipped)**

This message is displayed if there is a problem with the haptic steering wheel system.

We recommend that you have the vehicle inspected by an authorized retailer of Genesis Branded products.

**Check headlight (if equipped)**

This message is displayed if the headlights are not operating properly. A lamp may need to be replaced.

We recommend that you have the vehicle inspected by an authorized retailer of Genesis Branded products.

**Check turn signal (if equipped)**

This message is displayed if the turn signal lamps are not operating properly. A lamp may need to be replaced.

We recommend that you have the vehicle inspected by an authorized retailer of Genesis Branded products.

**Check headlamp LED (if equipped)**

This message is displayed if there is a problem with the LED headlamp. We recommend that you have the vehicle inspected by an authorized retailer of Genesis Branded products.

**Shift to P to charge**

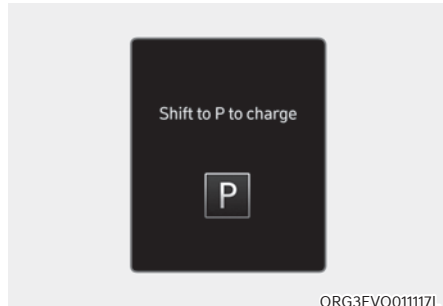

This message is displayed if you connect the charging cable without the gear in the P (Park) position.

Shift to P (Park) before connecting the charging cable.

**Remaining time**

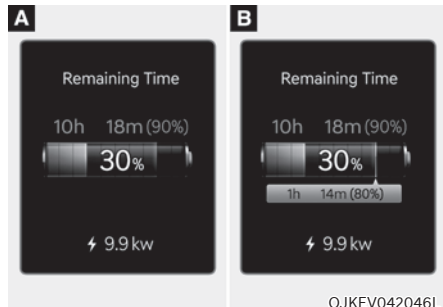

[A]: AC charge, [B]: DC charge

This message is displayed to notify the remaining time to charge the battery to the selected target battery charge level.

### **Unplug vehicle to start**

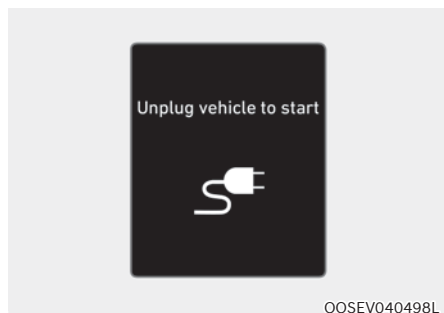

This message is displayed when you start the vehicle without unplugging the charging cable. Unplug the charging cable, and then turn on the vehicle.

### **Charging door open**

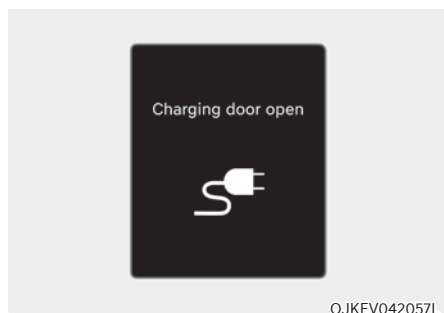

This message is displayed when the vehicle is driven with the charging door opened. Close the charging door and then start driving.

### **Charging stopped. Check the charger/Charging interrupted. Check the charger**

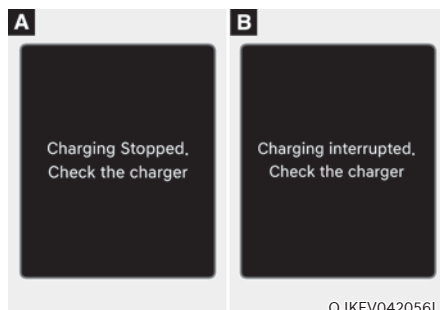

- This warning message is displayed when charging is stopped for the reasons below:
  - There is a problem with the external AC charger or DC charger
  - The external AC charger stopped charging
  - The charging cable is damaged

In this case, check whether there is any problem with the external AC or DC charger and charging cable.

If the same problem occurs when charging the vehicle with a normally operating AC charger or genuine Genesis portable charger, we recommend that you have your vehicle inspected by an authorized retailer of Genesis Branded products.

**Charging stopped. Check the cable connection/Charging interrupted. Please check the cable connection**

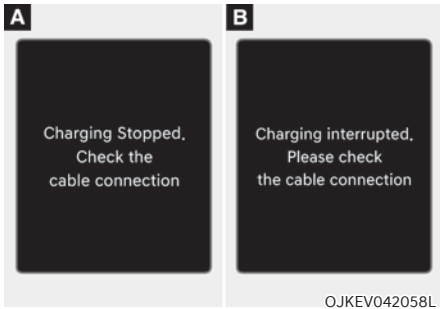

This warning message is displayed when charging is stopped because the charging connector is not correctly connected to the charging inlet

In this case, separate the charging connector and re-connect it and check whether there is any problem (external damage, foreign substances, etc.) with the charging connector and charging inlet.

If the same problem occurs when charging the vehicle with a replaced charging cable or genuine Genesis portable charger, we recommend that you have your vehicle inspected by an authorized retailer of Genesis Branded products.

**Check regenerative brakes**



These warning messages are displayed when the regenerative brake system does not work properly.

In this case, we recommend that you have the vehicle inspected by an authorized retailer of Genesis Branded products.

**Low EV battery/Low battery**

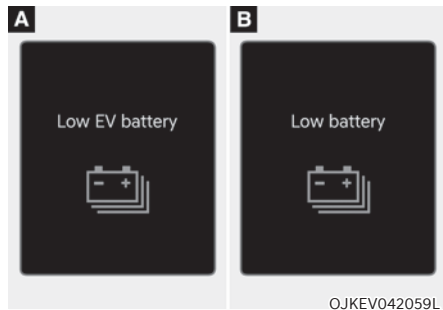

When the high voltage battery level reaches below approximately 10%, this warning message is displayed.

The warning light on the instrument cluster () will turn ON simultaneously. Charge the high voltage battery immediately.

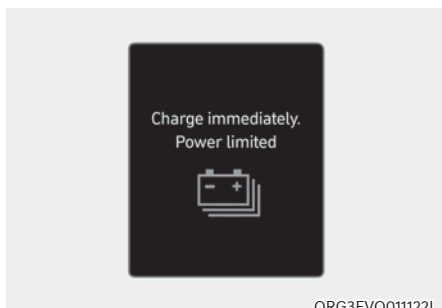
**Charge immediately. Power limited**

When the high voltage battery level reaches below approximately 5%, this warning message is displayed.

The warning light on the instrument cluster () will turn on simultaneously.

The vehicle's power will be reduced to minimize the energy consumption of the high voltage battery. Charge the battery immediately.

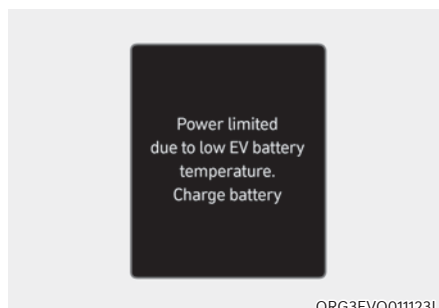
**Power limited due to low EV battery temperature. Charge battery**

Both warning messages are displayed to protect electric vehicle system when outside temperature is low. If the high voltage battery charging level is low and parked outside in low temperature for a long time, vehicle power could be limited.

Charging the battery before driving helps increase power.

**NOTICE**

**If these warning messages are still displayed even after the ambient temperature has increased, we recommend that you have the vehicle inspected by an authorized retailer of Genesis Branded products.**

**EV Battery Overheated! Stop vehicle/Battery overheated! Stop safely**

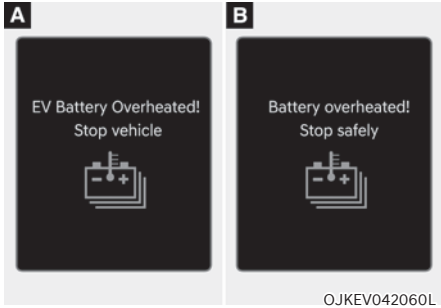

This warning message is displayed to protect battery and electric vehicle system when the high voltage battery temperature is too high.

Turn off the START/STOP button and stop the vehicle so that the battery temperature decreases.

**Power limited**



This warning message is displayed:

- When the power is limited for the safety of the high-powered parts of an electric vehicle. The power is limited for the following reasons. (Unless both Service Warning Light and Power Down Indicator Light illuminate at the same time, it is not a failure.)
  - The high voltage battery level is too low or voltage is decreasing
  - The temperature of the high voltage battery is too high or too low
  - The temperature of the motor is high

**NOTICE**

- **When this warning message is displayed, do not accelerate or start the vehicle suddenly.**
- **When the power is limited for the safety of the high-powered parts of an electric vehicle, the warning message is displayed. Your vehicle may not be driven, or may roll back on a slope with the warning message displayed due to the limitation of vehicle power.**



### **Stop vehicle and check power supply/Stop safely and check power supply**

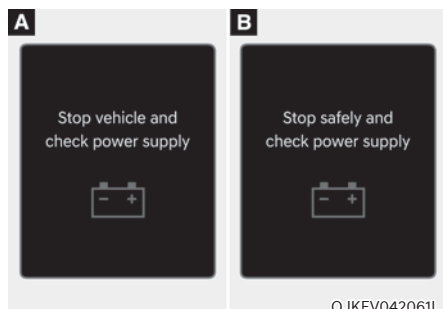

OJKEV042061L

This warning message is displayed when a failure occurs in the power supply system.

In this case, park the vehicle in a safe location and we recommend that you have your vehicle towed to the nearest by an authorized retailer of Genesis Branded products.

### **Check virtual engine sound system**

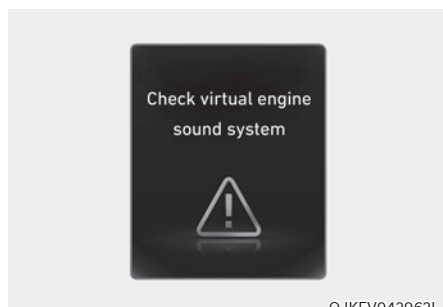

OJKEV042062L

This message is displayed when there is a problem with the Virtual Engine Sound System (VESS).

In this case, we recommend that you have the vehicle inspected by an authorized retailer of Genesis Branded products.

### **Check electric vehicle system**

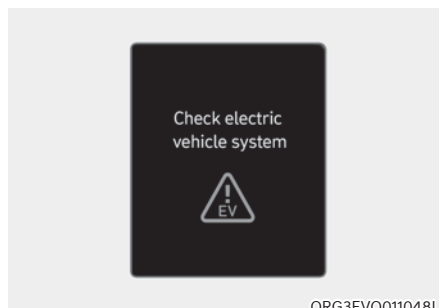

ORG3EVQ011048L

This warning message is displayed when there is a problem with the electric vehicle control system.

Refrain from driving when the warning message is displayed.

In this case, we recommend that you have the vehicle inspected by an authorized retailer of Genesis Branded products.

## LCD DISPLAY

### LCD display control

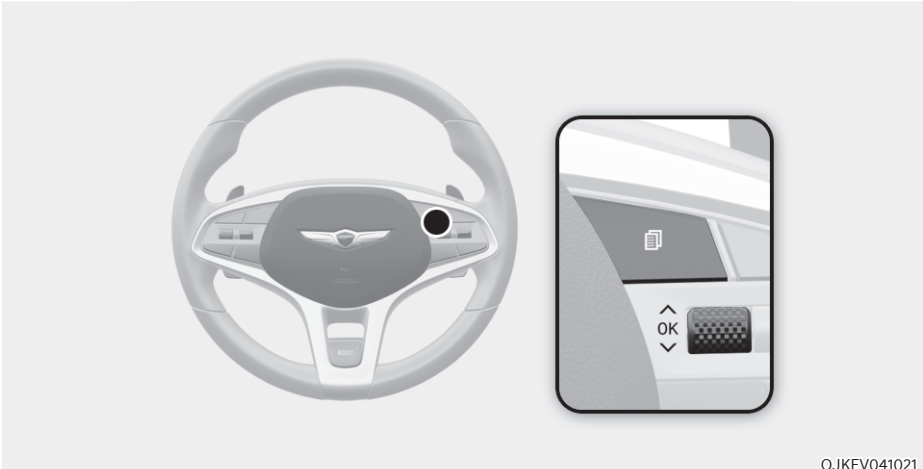

OJKEV041021

The LCD display modes can be changed by using the control switches.

Switch	Operation	Function
	Press	MODE button for changing View modes
	Press	UP, DOWN switch for changing items in Utility view and Option menu
OK	Press	SELECT/RESET switch for entering Option menu
	Press and hold	SELECT/RESET switch for retrieving assist information or resetting the selected item

### View modes

View modes	Explanation
Driving Assist	Driving Assist view displays the status of the vehicle's Driver Assistance systems.
Turn by Turn	Turn By Turn view displays the state of the navigation.
Utility	Utility view displays driving information such as the trip distance, electric energy economy and etc.

**The information provided may differ depending on which features are applicable to your vehicle.**

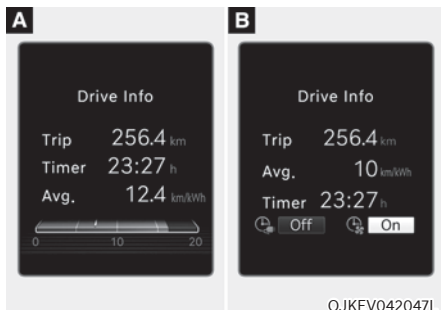

Driving Assist, Turn by Turn, Utility view modes are displayed in the center of the instrument cluster.

### *Driving Assist view*

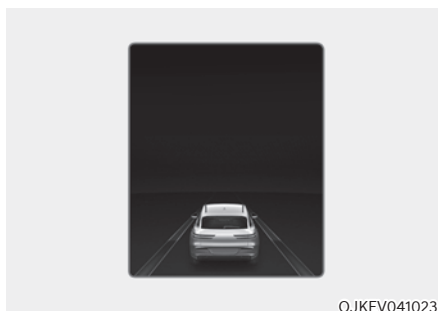

The status of Smart Cruise Control, Lane Following Assist, Highway Driving Assist, etc., is displayed when Driving Assist view is selected.

For more details, refer to each function information section in chapter 7.

### *Turn By Turn (TBT) view*

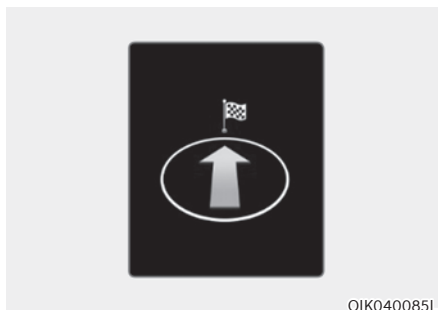

Turn-by-turn navigation, distance/time to destination information is displayed when Turn by Turn view is selected.

### Utility view

In the Utility view, using the  $\wedge$ ,  $\vee$  (UP, DOWN) switch, you may change through items in the following order.

#### 8-inch

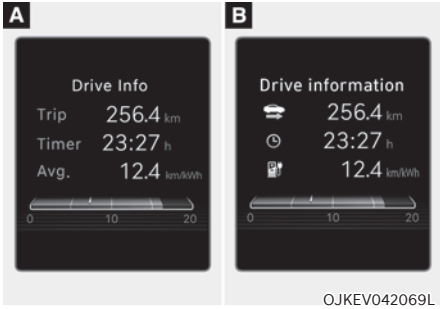

#### 12.3-inch 3D

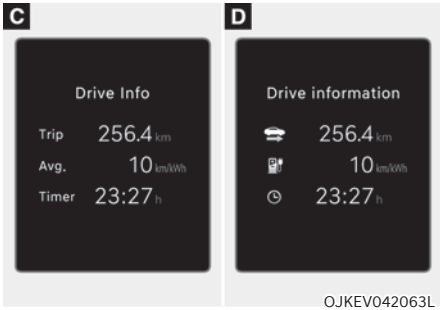

#### Drive info

This display shows the trip distance, the average energy consumption, and the total driving time.

The information is combined for each ignition cycle.

To manually reset the information, press and hold the OK button when viewing the Drive Info. The trip distance, the average energy consumption, and total driving time will reset simultaneously.

The driving information will continue to be counted while the vehicle is in the ready (READY) mode (for example, when the vehicle is in traffic or stopped at a stop light.)

### *i* Information

The vehicle must be driven for a minimum of 300 meters (0.19 miles) since the last ignition key cycle before the driving information is recalculated.

#### 8-inch

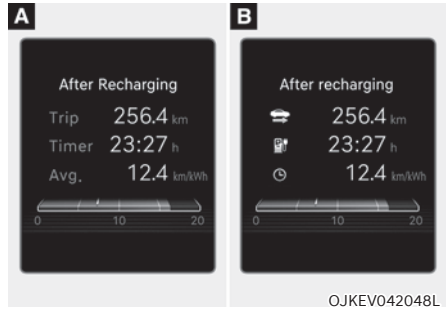

#### 12.3-inch 3D

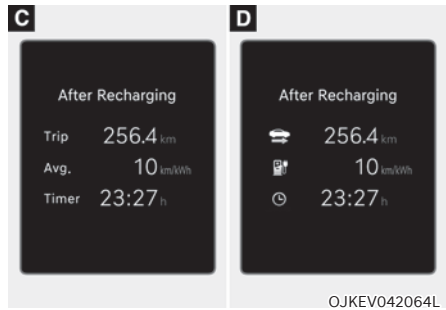

#### After Recharging

Trip distance, total driving time and average energy consumption after the vehicle has been recharged are displayed. To reset manually, press the OK button on the steering wheel for more than 1 second when 'After recharging' is displayed.

## 8-inch

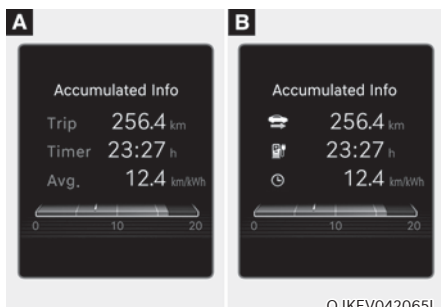

## 12.3-inch 3D

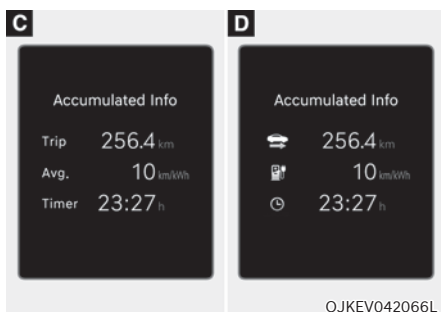

## Accumulated info

This display shows the accumulated trip distance, total driving time and average energy consumption.

The information is accumulated starting from the last reset.

To manually reset the information, press and hold the OK button when viewing the Accumulated driving info. The trip distance, the average energy consumption, and total driving time will reset simultaneously.

The accumulated driving information will continue to be counted while the vehicle is in the ready (**READY**) mode (for example, when the vehicle is in traffic or stopped at a stop light).

**i** Information

The vehicle must be driven for a minimum of 300 meters (0.19 miles) since the last ignition key cycle before the accumulated driving information is recalculated.

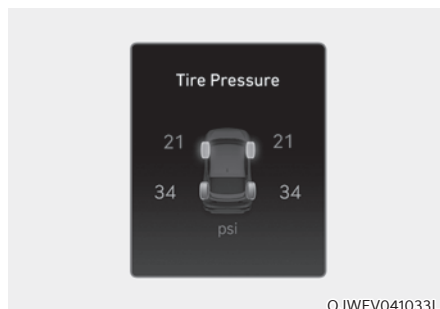

## Tire pressure

The tire pressure of each tire is displayed.

For more details, refer to “Tire Pressure Monitoring System (TPMS)” section in chapter 8.



**Energy flow/Driving force distribution (if equipped)**

- The electric vehicle system informs the drivers its energy flow in various operating modes.
- The distribution status of the driving power of the front and rear wheels are displayed when Auto 4WD mode is activated.

For more details, refer to "Four Wheel Drive (4WD)" section in chapter 6.

**Select contents/Contents configuration**

You can select the items to be displayed in Utility view.



1. Press and hold the OK switch on the steering wheel.

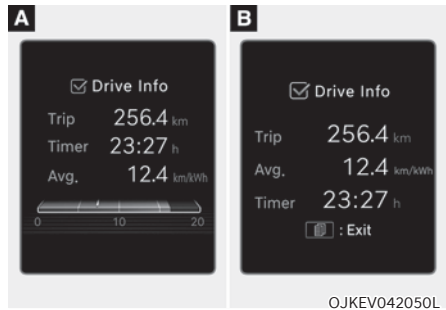

2. Use the  $\wedge$ ,  $\vee$  (UP, DOWN) switch to change items, and press the OK switch to select or deselect the item.
3. After selecting the items to be displayed in the Utility view, press the  $\text{MODE}$  button to exit the 'Select Contents' display.



### Driving assist information

The current operation conditions of Manual Speed Limit Assist, Smart Cruise Control, Lane Following Assist, Highway Driving Assist, etc., is displayed.

### Option menu

Press the OK switch to enter Option menu.



### WARNING

To avoid driver distractions, do not adjust the setting while driving which may lead to an accident.



### Information

The information provided may differ depending on which functions are applicable to your vehicle.

Menu	Explanation
Service messages	To check vehicle warning messages.
Head-up display (if equipped)	To activate or deactivate head-up display.
Driver Assistance settings	To directly display "Driver Assistance" menu on the infotainment system screen
Speed unit	To set speed unit between km/h and MPH.

### Service messages

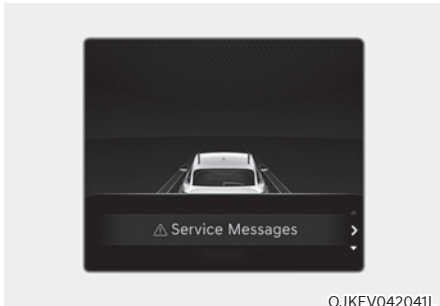

When Service Messages menu is selected, press the OK switch on the steering wheel to check vehicle warning messages.

### 3D cluster/3D effect (for 12.3-inch 3D cluster)



When 3D Cluster (3D effect) menu is selected, press the OK switch on the steering wheel. You may select or deselect 3D cluster effect by pressing the OK switch.

### Head-up display (if equipped)



When Head-Up Display menu is selected, press the OK switch on the steering wheel. You may select or deselect head-up display by pressing the OK switch.

### Driver Assistance settings



When Driver Assistance Settings menu is selected, press the OK switch on the steering wheel. The 'Driver Assistance' menu will be displayed on the infotainment system screen.



### Speed unit (if equipped)

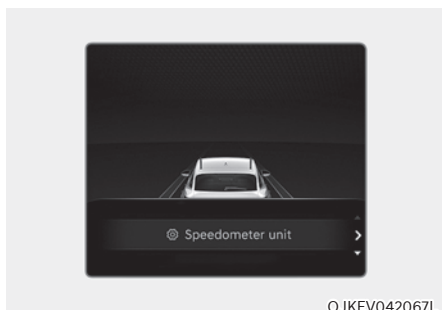

When the Speed Unit menu is selected, press the OK switch on the steering wheel. You can change the speed unit setting between km/h and MPH for the cluster.

### 3D instrument cluster (for 12.3-inch 3D cluster)

#### 3D cluster setting

To use the 3D cluster, press the Start/ Stop button to the ON position, and then select 'Setup → Vehicle Settings → 3D cluster depth → Medium/Light' in infotainment system screen.

To use the cluster 2D, select 'Off'.

For detailed information, scan the QR code in the separately supplied simple manual.

#### Recommendations to optimize the 3D effect

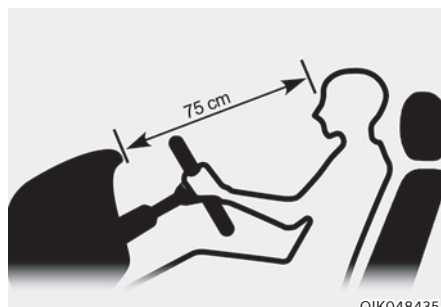

- Adjust the height of the seat and steering wheel so that the instrument cluster and camera module can be seen at a glance.
- The optimal distance to maximize the 3D effect is 75 cm (30 in.). Adjust the distance between the driver's seat and the instrument cluster.
- Hold the steering wheel with both hands and drive in an upright position.

 **Information**

- When your face gets too close or far to the instrument cluster, or the camera on the instrument cluster is blocked by the steering wheel or other objects, the 3D cluster changes to 2D automatically. However if the object blocking the camera is removed, the cluster changes back to 3D automatically.
- If outside temperature is below 4°C (39°F), it may change to 2D about 1 to 10 minutes.
- Two red lights may appear on the camera in the following conditions when:
  - The outside brightness is dim or driving at night
  - The vehicle drives inside a building, such as a basement parking lot
  - The camera case of the instrument cluster is partially damaged

 **CAUTION**

- It may sometimes be difficult to read information on the 3D cluster in the following situations. You must change the cluster to 2D for safe driving.
  - The driver is wearing sunglasses, special glasses, infrared cutoff glasses, refracting glasses or thick glasses
  - The driver has heavy eye makeup (eyeliner, mascara, color makeup, false eyelash) or eye piercing
  - The driver's view is blocked by his/her hair, etc.

- The driver is winking or wearing an eye patch on one eye
- The driver's face is covered partially by a mask, muffler, hijab, etc.
- The driver's view is blocked by incoming light from outside of the vehicle
- Light from outside, sunlight or infrared LED light of the camera is reflected on the glasses or sunglasses
- The driver turns or lowers his/her head so that the face or an eye is hidden from the camera
- The driver shakes his/her head up and down, or adverse road conditions cause excessive vehicle vibrations while driving
- The driver is too tall or short
- More than two people are looking at the instrument cluster simultaneously from the driver's seat
- The driver's eyesight of both eyes are severely different
- The driver has a severe headache
- Do not look toward the camera within 20 cm (8 in.) for longer than a minute.
- If you use the 3D cluster while your vehicle is stopped, it can cause eye strains or dizziness.
- We recommend people who are pregnant, elderly or has motion sickness, avoid using the cluster in 3D.

### WARNING

- You should not use the 3D cluster if you or any of your family members or relatives has a history of epilepsy, convulsions, etc. Flashing or flickering lights or specific or regular patterns shown on the cluster may stimulate epilepsy, convulsions, etc.
- You should not use the 3D effect immediately if you feel any of the following symptoms:  
Haziness, unconsciousness, disorientation, nausea, headache, fatigue, dizziness, etc.

### WARNING

While replacing the instrument cluster by yourself, be cautious of the heat from the top and backside of the instrument cluster.

### NOTICE



[A]: Interior view camera

- Do not apply any impact on the surface of the instrument cluster, interior view camera or around the area of the interior view camera. If interior view camera is damaged, the system may not operate properly.
- Do not place a mobile phone or an object in front of the interior view camera. The surface of the instrument cluster or interior view camera might be damaged due to an impact while driving.
- Do not place anything on interior view camera or in front of interior view camera while driving. Interior view camera may not operate properly.
- When cleaning the instrument cluster or interior view camera, wipe with a soft and clean cloth to prevent damages on the surface of the cluster or interior view camera lens. In addition, you should not use sharp tools near the cluster or interior view camera, or use chemicals to clean the cluster or interior view camera.
- Always keep interior view camera clean and dry.

## VEHICLE SETTINGS (INFOTAINMENT SYSTEM)



OJKEV042024L

Vehicle Settings in the infotainment system provides user options for a variety of settings including door lock/unlock features, convenience features, driver assistance settings, etc.

### Vehicle Settings menu

- Driver Assistance
- Drive Mode
- Active Sound Design
- Head-Up Display
- Cluster
- Climate
- Seat
- Lights
- Door/Tailgate
- Convenience

The information provided may differ depending on which functions are applicable to your vehicle.



### WARNING

**Do not operate the Vehicle Settings while driving. This may cause distraction resulting in an accident.**

### Setting your vehicle

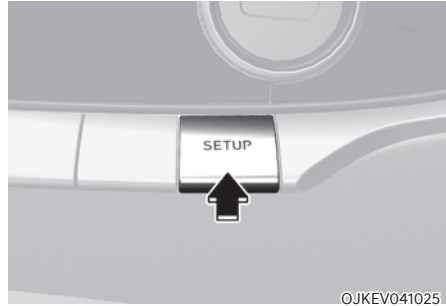

OJKEV041025

1. Press the SETUP button on the head unit of the infotainment system.



OJKEV042030L

2. Select 'Vehicle' to change the Vehicle Settings.

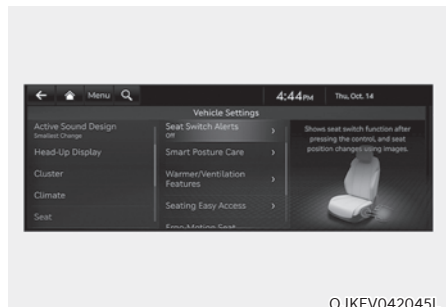

OJKEV042045L

For detailed information, scan the QR code in a separately supplied simple manual.

# 5. Convenience features

Accessing your vehicle .....	5-5
Using smart key .....	5-5
Smart key precautions .....	5-9
Replacing the battery .....	5-10
Immobilizer system .....	5-11
Fingerprint authentication system .....	5-12
Fingerprint authentication system settings .....	5-12
Fingerprint authentication system operation .....	5-13
Limitations of the system .....	5-14
When purchasing a used vehicle .....	5-14
Door locks.....	5-15
Operating door locks from outside the vehicle.....	5-15
Operating door locks from inside the vehicle .....	5-16
Deadlocks .....	5-19
Automatic door lock and unlock features .....	5-19
Child-protector rear door locks.....	5-20
Electronic child safety lock.....	5-20
Theft-alarm system.....	5-22
Advanced Rear Occupant Alert (ROA).....	5-23
System setting .....	5-23
System operation .....	5-23
System precautions.....	5-24
Declaration of Conformity.....	5-25
Integrated memory system.....	5-26
Storing memory positions .....	5-26
Recalling memory positions.....	5-27
Resetting the system .....	5-27
Seat easy access .....	5-28
Steering wheel .....	5-29
MDPS (Motor Driven Power Steering) .....	5-29
Tilt/Telescopic steering.....	5-30
Horn.....	5-31
Heated steering wheel.....	5-32

Mirrors .....	5-34
Inside rearview mirror .....	5-34
Outside rearview mirrors .....	5-35
Reverse parking aid .....	5-37
Windows .....	5-39
Power windows .....	5-41
Panorama sunroof.....	5-44
Power sunshade .....	5-44
Tilt open/close.....	5-45
Slide open/close.....	5-45
Automatic reversal .....	5-46
Resetting the sunroof .....	5-47
Sunroof open warning .....	5-48
Exterior features.....	5-48
Hood.....	5-48
Front trunk .....	5-49
Power tailgate.....	5-51
Smart tailgate .....	5-58
Charging door.....	5-61
Head-Up Display (HUD).....	5-62
Head-up display settings.....	5-62
Head-up display information .....	5-62
Precautions while using the head-up display .....	5-63
Exterior lights .....	5-64
Lighting control .....	5-64
High beam operation .....	5-66
Turn signals and lane change signals .....	5-66
Rear fog lamp .....	5-67
Battery saver function.....	5-67
Headlamp delay function .....	5-67
Headlight leveling device .....	5-68
Headlamp moisture removal function.....	5-68
Reverse guide lamp.....	5-68

# 5. Convenience features

Interior lights .....	5-69
Interior lamp AUTO cut .....	5-69
Front lamps .....	5-69
Rear lamps .....	5-70
Vanity mirror lamp.....	5-70
Glove box lamp.....	5-70
Door handle lamp/Mood lamp/Door courtesy lamp .....	5-71
Luggage compartment lamp .....	5-71
Puddle lamp.....	5-71
Welcome system .....	5-72
Intelligent Front-Lighting System (IFS) .....	5-73
Intelligent Front-Lighting System settings .....	5-73
Intelligent Front-Lighting System operation .....	5-73
Intelligent Front-Lighting System malfunction and limitations .....	5-74
High Beam Assist (HBA) .....	5-77
High Beam Assist settings .....	5-77
High Beam Assist operation .....	5-78
High Beam Assist malfunction and limitations .....	5-79
Wipers and washers.....	5-80
Front windshield wipers.....	5-80
Front windshield washers .....	5-82
Rear window wiper and washer .....	5-83
Automatic climate control system.....	5-84
Automatic temperature control mode.....	5-86
Manual temperature control mode.....	5-87
System operation .....	5-97
System maintenance .....	5-99
Windshield defrosting and defogging.....	5-101
To defog inside windshield .....	5-101
To defrost outside windshield .....	5-102
Defogging logic .....	5-102
Rear window defroster .....	5-103

Climate control additional features .....	5-104
Auto defogging system .....	5-104
Auto dehumidify .....	5-105
Recirculating air when washer fluid is used .....	5-106
Auto. Controls That Use Climate Control Settings (for driver's seat) .....	5-106
Storage compartment .....	5-108
Center console storage .....	5-108
Glove box .....	5-108
Sunglass holder .....	5-109
Mobile phone holder .....	5-109
Interior features .....	5-110
Cup holder .....	5-110
Ashtray .....	5-111
Sunvisor .....	5-111
Power outlet .....	5-112
USB charger .....	5-113
Wireless smart phone charging system .....	5-114
Clock .....	5-116
Coat hook .....	5-116
Floor mat anchor(s) .....	5-116
Rear side window sunshades .....	5-118
Luggage net holder .....	5-118
Cargo security screen .....	5-119
Exterior features .....	5-121
Roof side rails .....	5-121
Infotainment system .....	5-122
USB Port .....	5-122
Antenna .....	5-122
Steering wheel remote controls .....	5-122
Infotainment system .....	5-123
Voice recognition .....	5-123
Bluetooth® Wireless Technology .....	5-124
Lexicon premium sound system .....	5-124



## ACCESSING YOUR VEHICLE

### Using smart key

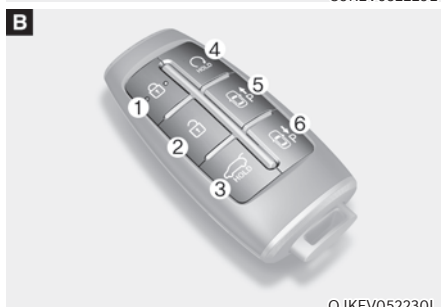
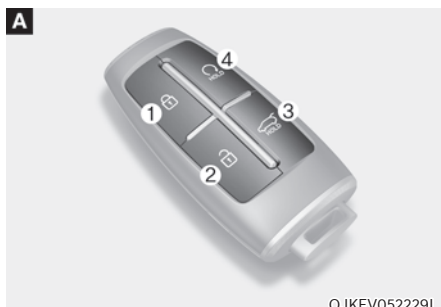

Your Genesis Branded Vehicle uses a Smart Key, which you can use to lock or unlock the driver and passenger doors or the rear tailgate.

1. Door lock
2. Door unlock
3. Tailgate open/close
4. Remote start
5. Forward
6. Backward

### Locking your vehicle



To lock your vehicle using the door handle touch sensor or the Smart Key:

1. Make sure all doors, the hood and the tailgate are closed.
2. Make sure you have the smart key in your possession.
3. Touch the touch sensor on the door handle (the engraved part) or press the Door Lock button (1) on the smart key. The hazard warning lights will blink.
4. Make sure the doors are locked by pulling the door handle.

### **i** Information

- **The outside rearview mirror will fold if 'Enable on Door Unlock' is selected from the Settings menu in the infotainment system screen. Select:**
  - Setup → Vehicle Settings → Lights → Welcome Mirror/Light → Enable on Door Unlock
- **The door handle touch sensor will only operate when the smart key is within 0.7~1 m (28~40 in.) from the outside door handle.**
- **Touching the door handle touch sensor does not unlock the doors. To unlock the doors, refer to the following page.**

**Note that you cannot lock your vehicle using the door handle touch sensor if any of the following occur:**

- **The Smart Key is in the vehicle.**
- **The Start/Stop button is in ACC or ON position.**
- **Any of the doors are open except for the tailgate.**



**WARNING**

**Do not leave the Smart Key in your vehicle with unsupervised children. Unattended children could press the Start/ Stop button and may operate power windows or other controls, or even make the vehicle move, which could result in serious injury or death.**

***Unlocking your vehicle***

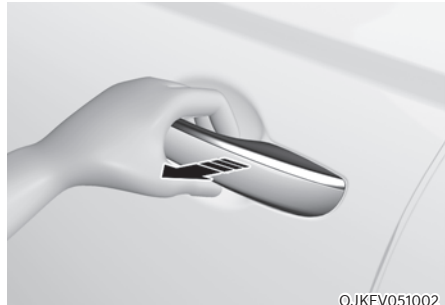

OJKEV051002

To unlock your vehicle using the door handle touch sensor or the Smart Key:

1. Make sure you have the smart key in your possession.
2. Put your hand in the door handle or press the Door Unlock button (2) on the smart key. All doors will unlock and the hazard warning lights will blink two times.
3. After unlocking the doors, the doors will automatically re-lock after 30 seconds unless a door is opened.

## **i** Information

- The outside rearview mirror will unfold if 'Enable on Door Unlock' is selected from the Settings menu in the infotainment system screen. Select:
  - Setup → Vehicle Settings → Lights → Welcome Mirror/Light → Enable on Door Unlock
- The door handle touch sensor will only operate when the smart key is within 0.7~1 m (28~40 in.) from the outside door handle.
- The doors may lock or unlock if the touch sensor of the outer door handle is recognized while washing your car or due to heavy rain.
- To prevent unintentional door lock or unlock:

Press the lock button on the smart key and immediately press the unlock button along with the lock button for more than 4 seconds. The hazard warning lights will blink four times. At this time, the doors will not lock or unlock even though the touch sensor is touched on the outside door handle.

To deactivate the function, press the door lock or unlock button on the smart key.

- The doors may not lock or unlock in the following situations.
  - If the touch sensor is touched with gloves on
  - If the door is suddenly approached
- During a car wash or rain, in order to minimize unintentional operation of the touch sensor, the touch sensor may become insensitive. This is not a malfunction.

## Opening the tailgate



To open the tailgate:

1. Make sure you have the smart key in your possession.
2. Press either the tailgate open/close button on the vehicle or press and hold the Tailgate Unlock button (3) on the smart key for more than one second. The hazard warning lights will blink two times and the tailgate will open.

## **i** Information

The tailgate open/close button will only operate when the smart key is within 0.7 m (28 in.) from the tailgate.

### **Remotely starting vehicle (if equipped)**

You can start the vehicle using the Remote Start button (4) on the smart key.

To start the vehicle remotely:

1. Press the door lock button on the smart key within 10 m (32 feet) from the vehicle.
2. Press the Remote Start button (4) for more than 2 seconds within 4 seconds after pressing the door lock button.
3. The vehicle will start (READY indicator on).
4. To turn off the remote start function, press the Remote Start button (4) once.

### ***i* Information**

- The vehicle must be in P (Park) for the remote start function to start.
- The vehicle turns off (READY indicator off) if you get in the vehicle without a registered smart key.
- The vehicle turns off (READY indicator off) if you do not get in the vehicle within 10 minutes after remotely starting the vehicle.
- The Remote Start button (4) may not operate if the smart key is not within 10 m (32 feet).
- The vehicle will not remotely start if the hood or tailgate is opened.

### **Remotely moving vehicle forward or backward (if equipped)**

With the smart key, the driver can move the vehicle forward or backward using the Forward or Backward button (5, 6) on the smart key.

For more details, refer to “Remote Smart Parking Assist (RSPA)” section in chapter 7.

### **Start-up**

You can start the vehicle without inserting the key.

For more details, refer to the “Start/Stop Button” section in chapter 6.

### ***i* Information**

If the smart key is not moved for some time, the detection function for smart key operation will pause. Lift the smart key to activate the detection again.

### **NOTICE**

To prevent damaging the smart key:

- Keep the smart key in a cool, dry place to avoid damage or malfunction. Exposure to moisture or high temperature may cause the internal circuit of the smart key to malfunction which may not be covered under warranty.
- Avoid dropping or throwing the smart key.
- Protect the smart key from extreme temperatures.

### Using mechanical key

If the Smart Key does not operate normally, you can lock or unlock the driver's door by using the mechanical key.

To remove the mechanical key from the smart key FOB:

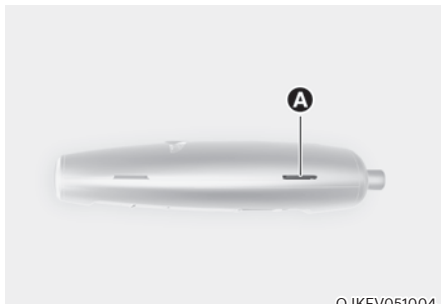

OJKEV051004

1. Place a soft cloth over the groove (A), and using a flat-head screw driver pry open the smart key cover.

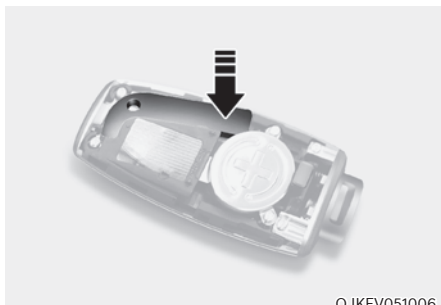

OJKEV051006

2. Press the mechanical key and remove it from the smart key FOB.
3. After use, reinstall the mechanical key and smart key cover in the reverse order of removal.

### Loss of a smart key

A maximum of three Smart Keys can be registered to a single vehicle. If you happen to lose your smart key, it is recommended that you should immediately take the vehicle and remaining keys to your authorized retailer of Genesis Branded products or tow the vehicle, if necessary.

### Smart key precautions

The smart key may not work if any of the following occur:

- The smart key is close to a radio transmitter such as a radio station or an airport which can interfere with normal operation of the transmitter.
- The smart key is near a mobile two way radio system or a mobile phone.
- Another vehicle's smart key is being operated close to your vehicle.

If the smart key does not work correctly, open and close the door with the mechanical key. If you have a problem with the smart key, it is recommended to contact an authorized retailer of Genesis Branded products.

If the smart key is in close proximity to your mobile phone, the signal could be blocked by your mobile phone's normal operational signals. This is specifically relevant when the phone is active such as making and receiving calls, text messaging, and/or sending/receiving emails. When possible, avoid keeping the smart key and your mobile phone in the same location such as a pants or jacket pocket in order to avoid interference between the two devices.

**NOTICE**

- Keep the smart key away from electromagnetic materials that blocks electromagnetic waves to the key surface.
- Always have the smart key with you when leaving the vehicle. If the smart key is left near the vehicle, the vehicle battery may be discharged.

**Replacing the battery**

If the Smart Key is not working properly, try replacing the battery with a new one.

Battery Type: CR2032

To replace the battery:

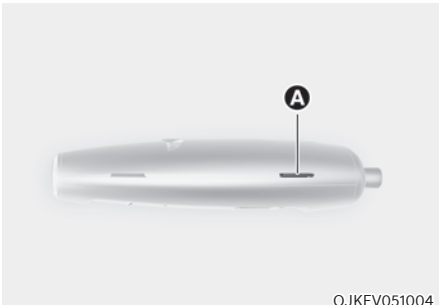

OJKEV051004

1. Place a soft cloth over the groove (A), and using a flat-head screwdriver pry open the smart key cover.



OJKEV051005

2. Remove battery cover using a phillips screwdriver.
3. Remove the old battery and insert the new battery. Make sure the battery position is correct.
4. Reinstall the battery cover and smart key cover in the reverse order of removal.

If you suspect your smart key might have sustained some damage, or you feel your smart key is not working correctly, it is recommended that you contact an authorized retailer of Genesis Branded products.



**WARNING**

**THIS PRODUCT CONTAINS A BUTTON BATTERY.**

**If swallowed, a lithium button battery can cause severe or fatal injuries within 2 hours. Keep batteries out of reach of children.**

**If you think batteries may have been swallowed or placed inside any part of the body, seek immediate medical attention.**



**Information**



**An inappropriately disposed battery can be harmful to the environment and human health. Dispose of the battery according to your local law(s) or regulations.**

## Immobilizer system

The immobilizer system helps protect your vehicle from theft. If an improperly coded key (or other device) is used, the vehicle system is disabled.

When the Start/Stop button is pressed to the ON position, the immobilizer system indicator should come on briefly, then go off. If the indicator starts to blink, the system does not recognize the coding of the key.

Press the Start/Stop button to the OFF position, then press the Start/Stop button to the ON position again.

In some circumstances, the vehicle may not recognize your smart key if another smart key device is nearby or a metal object such as a key chain is causing interference with the smart key.

If this occurs, your vehicle may not start. Remove any metal objects or additional keys near the smart key before attempting to start the vehicle again.

If the system repeatedly does not recognize the coding of the key, it is recommended that you contact an authorized retailer of Genesis Branded products.

Do not attempt to alter this system or add other devices to it. Electrical problems could result that may make your vehicle inoperable.



## WARNING

**In order to prevent theft of your vehicle, do not leave spare keys anywhere in your vehicle. Your immobilizer password is a customer unique password and should be kept confidential.**

## NOTICE

**The transponder in your key is an important part of the immobilizer system. It is designed to give years of trouble-free service, however you should avoid exposure to moisture, static electricity and rough handling. Immobilizer system malfunction could occur.**

## FINGERPRINT AUTHENTICATION SYSTEM (IF EQUIPPED)

Fingerprint authentication system allows the driver to have access to personal information, unlock profile and exit valet mode with a enrolled fingerprint.

### Fingerprint authentication system settings

To use the system, the driver's fingerprint should be enrolled in the driver's profile. The drivers can set or delete their fingerprint through the infotainment system. Follow the following procedure.

#### Enrolling fingerprint

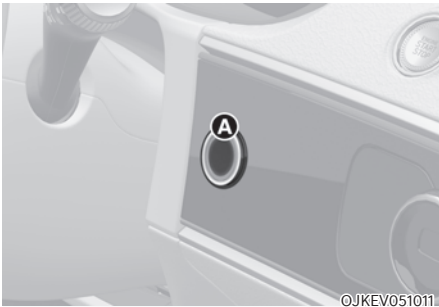

[A]: Fingerprint sensor

1. Turn on the vehicle.
2. Select 'Setup → User Profile Settings → Driver 1 (or Driver 2) → Fingerprint Identification → Set/Delete Fingerprint → Set' in the infotainment system screen.
3. Place your finger that you wish to enroll on the fingerprint sensor according to the instruction.
4. Following the instructions, place several parts of your fingerprint until the scanning process is complete.
5. Once the scanning process is completed, the message 'Saving fingerprint... ' appears and the fingerprint enrollment process is proceeded.

6. When the fingerprint enrollment process is completed in the vehicle, the status is displayed on the infotainment system.

#### Deleting fingerprint

1. Select 'Setup → User Profile Settings → Driver 1 (or Driver 2) → Fingerprint Identification → Set/Delete Fingerprint → Delete' in the infotainment system.
2. Delete the enrolled fingerprint according to the message 'Delete all Driver 1 fingerprints?'
3. Once the fingerprint is deleted, the status is displayed on the infotainment system screen.

#### **i** Information

- **If no fingerprint is enrolled in the infotainment system, the sensor will not operate.**
- **The maximum of two fingerprint can be enrolled. Driver 1 and Driver 2 can enroll one fingerprint each.**
- **Please remove all substances including protection film on the fingerprint sensor and enroll your fingerprint.**
- **The fingerprint enrollment process is cancelled when the following condition occurs:**
  - **The infotainment system screen is altered.**
  - **The Start/Stop button turns on or off.**
  - **The gear is shifted and the vehicle is driven.**



**CAUTION**

Do not participate in duplicating your fingerprint with anyone.

**NOTICE**

Touch the fingerprint authentication sensor gently. Fingerprint authentication attempts with excessive force may fail.

## Fingerprint authentication system operation

### *Using features with touch control*

The convenient features such as personal information access, profile unlock, and valet mode exit are available with the fingerprint authentication system.

When the fingerprint shape appears on the infotainment system screen, you should place your finger on the recognition sensor in the vehicle according to the instruction message for authorization and then you can operate the linked features without entering the password.

If the fingerprint authentication system does not work, pull your finger away from the fingerprint authentication sensor and then try again.

Fingerprint linked features can be turned on or off from the Settings menu. Select:

- 'Setup → User Profile Settings → Driver 1 (or Driver 2) → Fingerprint Identification

Fingerprint linked features	Characteristic
Personal information access	Use with a fingerprint without a password
Profile unlock	
Valet mode exit	

For detailed information, scan the QR code in the separately supplied simple manual.

**Information**

**You cannot link a profile with the same fingerprint for Driver 1 and Driver 2. The personalization function works with the recently linked profile, and the previously linked profile will be automatically cancelled.**

### Limitations of the system

- Fingerprint authentication system may not work when:
  - Trying to authorize with unregistered fingerprint.
  - Not touching the center of fingerprint authentication sensor.
  - Any water or substances is on your finger or the sensor.
  - The film on the sensor is not removed.
  - The registered fingerprint is damaged or swollen.
  - The hand is overly dry.
  - The sensor is touched shortly.
- If fingerprint authentication fails repeatedly, fingerprint authentication may be temporarily restricted. You should try it later or try other methods such as inputting your password.
- When you visit an authorized retailer of Genesis Branded products to repair parts due to fingerprint authorization system or related part failure, your registered fingerprint might be deleted. Have your smart key when you visit an authorized retailer of Genesis Branded products.
- You cannot use the fingerprint sensor when the vehicle is discharged.
- If you turn the vehicle on or off during the fingerprint authentication process, the process will not be complete.



### WARNING

**Do not enroll children's fingerprints in the vehicle.**

**If you enroll children's fingerprints and leave them in the vehicle, unexpected accidents may occur.**

### When purchasing a used vehicle

If you purchase a used vehicle, you should confirm and delete all of the enrolled fingerprints in Driver 1 and Driver 2 profile.

## DOOR LOCKS

### Operating door locks from outside the vehicle

#### Using mechanical key

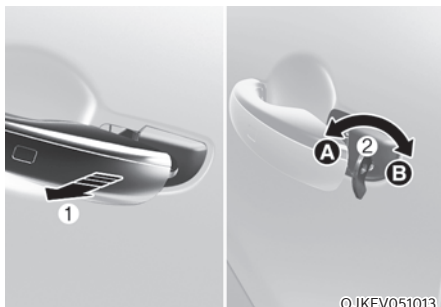

[A]: Lock, [B]: Unlock

After pulling the door handle (1), turn the key (2) toward the front of the vehicle to lock (A) or turn the key toward the rear of the vehicle to unlock (B).

If you lock the driver's door with a mechanical key, the driver's door will lock. If you unlock the driver's door with a mechanical key, the driver's door will unlock.

Once the doors are unlocked, they may be opened by pulling the door handle. When closing the door, push the door by hand. Make sure that doors are closed securely.

#### **NOTICE**

**Do not apply excessive force on the door and door handle. It may damage the door and door handle.**

#### **i** Information

**When the keyhole freezes and does not open, lightly tap or indirectly warm (for example, hand temperature) the keyhole.**

#### Using smart key

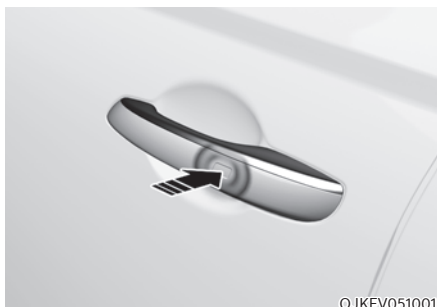

#### Lock

Touch the touch sensor on the front outside door handle (the engraved part) while carrying the Smart Key with you or press the Door Lock button on the Smart Key, all doors will lock.



#### Unlock

Put your hand in the front outside door handle while carrying the Smart Key with you or press the Door Unlock button on the Smart Key, all doors will unlock.

Once the doors are unlocked, they may be opened by pulling the door handle.

When closing the door, push the door by hand. Make sure that doors are closed securely.

For more details, refer to "Smart Key" in the previous pages.

**i** Information

- In cold and wet climates, door lock and door mechanisms may not work properly due to freezing conditions.
- If the door is locked/unlocked multiple times in rapid succession with either the vehicle key or door lock switch, the system may stop operating temporarily in order to protect the circuit and prevent damage to system components.

**Operating door locks from inside the vehicle**

*With the door handle*



**Front door**

If the inner door handle is pulled when the door is locked, the door will unlock and open.

**Rear door**

If the inner door handle is pulled once when the door is locked, the door will unlock. If the inner door handle is pulled once more, the door will open.

If any door is opened, the doors will not lock even though the central door lock switch is pressed.

**i** Information

**If a power door lock ever fails to function while you are in the vehicle try one or more of the following techniques to exit:**

- Operate the door unlock feature repeatedly (both electronic and manual) while simultaneously pulling on the door handle.
- Operate the other door locks and handles, front and rear.
- Lower a front window and use the mechanical key to unlock the door from outside.

## Using the door lock/unlock switch





OJKEV051015



OJKEV051016

[A]: Driver's door, [B]: Front passenger's door

### Driver and passenger door central door lock switch

The driver and passenger side door armrest is equipped with a central door lock switch. The lock switch is indicated by a  symbol. The unlock switch is indicated by a  symbol.

When the lock switch (1) is pressed (door indicator light ON), all the vehicle doors will lock.

When the unlock switch (2) is pressed, all the vehicle doors will unlock.

If any door is opened, the doors will not lock even though the central door lock switch (1) is pressed.

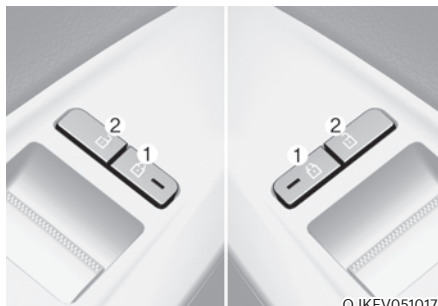

OJKEV051017

### Rear door

When the lock switch (1) is pressed (door indicator light ON), all the vehicle doors will lock.

When the unlock switch (2) is pressed, all the vehicle doors will unlock.

### Information

**If all doors are locked with the rear door lock switch, and the electronic child safety lock button (if equipped) in the driver's seat is turned ON (indicator light ON), the rear doors cannot be opened. If you want to open the rear doors:**

- **Unlock the door with the smart key from outside when the vehicle is in OFF position.**
- **Press the electronic child safety lock button on the driver's door to turn it off (indicator light OFF), then unlock the doors with the driver's or passenger's central door lock switch. (Electronic child lock OFF → Door unlocked)**
- **Press the electronic child safety lock button on the driver's door to turn it off (indicator light OFF), then pull the rear inner door handle twice.**

### In case of an emergency

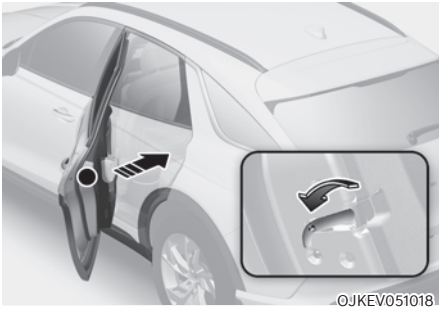

In case of emergency such as when the battery is discharged, the only way to lock the door(s) is with the mechanical key from the outside key hole.

Doors without an outside key hole can be locked as follows:

1. Open the door.
2. Insert the key into the emergency door lock hole and turn the key to the lock position.
3. Close the door securely.



### Information

If the electrical power door lock switch does not operate (for example, dead car battery) and the tailgate is closed, you will not be able to open the tailgate until power is restored.



### WARNING

- The doors should always be fully closed and locked while the vehicle is in motion. If the doors are unlocked, the risk of being thrown from the vehicle in a crash is increased.
- Do not pull the inner door handle of the driver's or passenger's door while the vehicle is moving.



### WARNING

Do not leave the elderly, children or animals unattended in your vehicle. An enclosed vehicle can become extremely hot, causing death or serious injury to the elderly, unattended children or animals who cannot escape from the vehicle. Children might operate features of the vehicle that could injure them, or they could encounter other harm, possibly from someone gaining entry to the vehicle.



### WARNING

Always secure your vehicle.

Leaving your vehicle unlocked increases the potential risk to you or others from someone hiding in your vehicle.

To secure your vehicle, while depressing the brake, shift the gear to the P (Park) position, engage the parking brake, and press the Start/ Stop button to the OFF position, close all windows, lock all doors, and always take the key with you.

**CAUTION**

Opening a door when something is approaching may cause damage or injury. Be careful when opening doors and watch for vehicles, motorcycles, bicycles or pedestrians approaching the vehicle in the path of the door.

**WARNING**

If you stay in the vehicle for a long time while the weather is very hot or cold, there are risks of injuries or danger to life. Do not lock the vehicle from the outside when someone is in the vehicle.

**Deadlocks (if equipped)**

Some vehicles are equipped with a deadlock system. Deadlocks prevent opening of a door from either inside or outside the vehicle once the deadlocks have been activated providing an additional measure of vehicle security.

To lock the vehicle using the deadlock function, the doors must be locked by using the smart key. To unlock the vehicle, the smart key must be used again.

**Automatic door lock and unlock features**

Your vehicle is equipped with features that will automatically lock or unlock your vehicle based on settings you select in the infotainment system screen.

***Auto LOCK Enable on driving***

When this feature is set in the infotainment system screen, all the doors will be locked automatically when the vehicle exceeds 15 km/h (9 mph).

***Auto UNLOCK Upon vehicle Off***

When this feature is set in the infotainment system screen, all the doors will be unlocked automatically when the vehicle is turned off.

For more details, on these features, scan the QR code in a separately supplied simple manual.

***Additional unlock safety feature air bag deployment***

As an additional safety feature, all doors will be automatically unlocked when an impact causes the air bags to deploy.

### Child-protector rear door locks (if equipped)

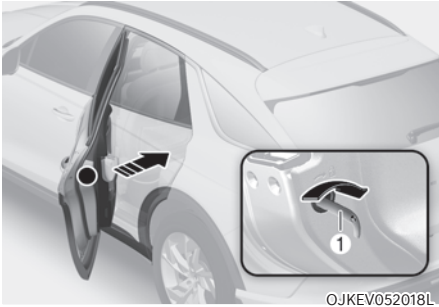

The child safety lock is provided to help prevent children seated in the rear from accidentally opening the rear doors. The rear door safety locks should be used whenever children are in the vehicle.

The child safety lock is located on the edge of each rear door. When the child safety lock is in the lock position, the rear door will not open if the inner door handle is pulled.

To lock the child safety lock, insert a small flat blade tool (like a screwdriver or similar) (1) into the slot and turn it to the lock position as shown.

To allow a rear door to be opened from inside the vehicle, unlock the child safety lock.

#### **WARNING**

**If children accidentally open the rear doors while the vehicle is in motion, they could fall out of the vehicle. The rear door safety locks should always be used whenever children are in the vehicle.**

### Electronic child safety lock (if equipped)



When the electronic child safety lock button is pressed and the indicator light on the button illuminates, the rear doors cannot be opened from inside the vehicle.

- The rear door window cannot be opened or closed while the electronic child safety lock button is in the LOCK position (indicator light ON).  
For more details, refer to “Windows” section in this chapter.
- Electronic child safety lock does not automatically turn on unless the driver presses the electronic child safety lock button.
- If 3 minutes passes after the Start/ Stop button is pressed to the OFF or ACC, the indicator on the button turns off, and the driver cannot turn off electronic child safety lock by pressing the button. To turn off the function, press the Start/Stop button to the ON position, and then press the electronic child safety lock button.



- If the power is supplied again after removing the battery or battery is discharged while the electronic child safety lock button is in the LOCK position, press the button once more to match the state of the indicator on the electronic child safety lock button and actual status of the electronic child safety lock function.
- If the airbag is activated while the electronic child safety lock button is in the LOCK position (indicator light ON), the rear doors will unlock automatically.
- Vehicles equipped with the electronic child safety lock feature is not provided with a manual child safety lock.



## WARNING

If children accidentally opens the rear door while the vehicle is in motion, they could fall out of the vehicle. Electronic child safety lock should always be used whenever children are in the vehicle.

## NOTICE

### Child safety lock failure/Child safety lock error

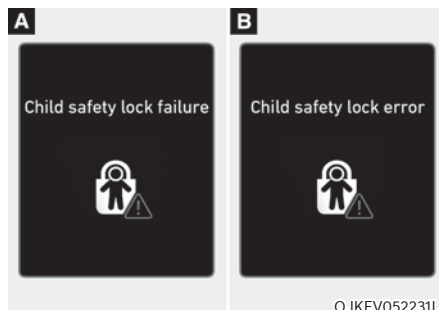

When electronic child safety lock does not work even though the button is pressed, the message will be displayed and an alarm will sound. If this occurs, we recommend that the vehicle be inspected by an authorized retailer Genesis Branded products.

### *Safe Exit Assist (if equipped with electronic child safety lock)*

Safe Exit Assist helps prevent the rear occupant from opening the rear door. When an approaching vehicle from the rear area is detected after the vehicle stops, the rear doors will not unlock even when the driver tries to unlock the rear doors using the electronic child safety lock button.

For more details, refer to “Safe Exit Assist (SEA)” section in chapter 7.

## THEFT-ALARM SYSTEM

This system helps to protect your vehicle and valuables. The horn will sound and the hazard warning lights will blink continuously if any of the following occur:

- A door is opened without using the smart key.
- The tailgate is opened without using the smart key.
- The hood is opened.

The alarm continues for 30 seconds, then the system resets. To turn off the alarm, unlock the doors with the smart key.

The Theft Alarm System automatically sets 30 seconds after you lock the doors and the tailgate. For the system to activate, you must lock the doors and the tailgate from outside the vehicle with the smart key or by touching the touch sensor on the outside of the door handle with the smart key in your possession.

The hazard warning lights will blink and the chime will sound once to indicate the system is armed.

Once the security system is set, opening any door, the tailgate, or the hood without using the smart key will cause the alarm to activate.

The Theft Alarm System will not set if the hood, the tailgate, or any door is not fully closed. If the system will not set, check the hood, the tailgate, or the doors are fully closed.

Do not attempt to alter this system or add other devices to it.

### **i** Information

- **Do not lock the doors until all passengers have left the vehicle. If the remaining passenger leaves the vehicle when the system is armed, the alarm will be activated.**
- **If the vehicle is not disarmed with the smart key, open the doors by using the mechanical key and start the vehicle by directly pressing the Start/Stop button with the smart key.**
- **If the system is disarmed by unlocking the vehicle, but neither a door or the tailgate is opened within 30 seconds, the doors will relock and the system will rearm automatically.**

### **i** Information



Vehicles equipped with a theft alarm system will have a label attached to the vehicle with the following words:

1. **WARNING**
2. **SECURITY SYSTEM**

## ADVANCED REAR OCCUPANT ALERT (ROA) (IF EQUIPPED)

Advanced Rear Occupant Alert is provided to help prevent the driver from leaving the vehicle with the rear passenger left in the vehicle.

### System setting

To use Rear Occupant Alert, it must be enabled from the Settings menu in the infotainment system screen. Select:

- Setup → Vehicle Settings → Convenience → Rear Occupant Alert (ROA)

For detailed information, scan the QR code in the separately supplied simple manual.

### System operation

- First alert  
When you turn off the vehicle and open the driver's door after opening and closing the rear door or tailgate, the 'Check rear seat for passengers and belongings' warning message appears on the cluster.
- Second alert  
After the first alert, the second alert operates when any movement is detected in the vehicle after the driver's door is closed and all the doors are locked. The horn will sound for approximately 25 seconds. Also, a text message is sent to members of Genesis Connected Services (if available). If the system continues to detect a movement, the alert operates up to 8 times.  
Unlock the doors with the smart key to stop the alert.
- The system detects movement in the vehicle for 10 minutes after the door is locked.

**i** Information

- The second alert is available for vehicles equipped with the ROA sensor.
- Rear Occupant Alert also activates when movement is detected in the cargo area.
- The second alert is activated only after the prior activation of the first alert.



[A]: Cluster, [B]: Steering wheel

**If you do not want to use Rear Occupant Alert, press the OK button on the steering wheel when the first alert is displayed on the cluster. Doing so will deactivate the second alert one time.**

- **If the vehicle is started remotely (if equipped with Remote Start), inside movement detection will stop.**

**System precautions**

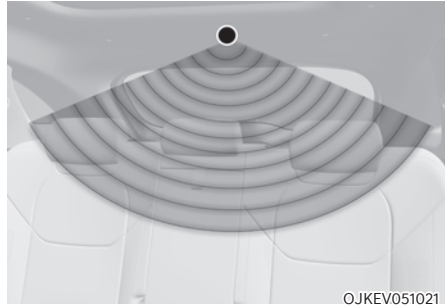

- Make sure that all the windows are closed. If the window is open, the alert may operate by the sensor detecting an unintended movement (for example, wind or bugs).
- The alert may operate if movement in the driver or passenger seat is detected.
- If the doors are locked with a passenger inside the vehicle, the alert may operate.
- An alert can occur if there is an impact on the vehicle.
- If boxes or objects are stacked in the vehicle, the system may not detect passengers. Or, the alert may operate if the boxes or objects fall off.
- The alert may operate when the vehicle is pushed or shaken, or while washed, or by surrounding noise or vibration after the vehicle is locked.
- The alert may operate when there are metallic or liquid objects in the vehicle.



## WARNING

Even if your vehicle is equipped with **Advanced Rear Occupant Alert (ROA)**, always make sure to check the rear seat before you leave the vehicle.

**Advanced Rear Occupant Alert (ROA)** may not operate when:

- Movement does not continue for a certain period of time or the movement is small.
- A child is not seated in a child restraint system.
- The detection signal is weak because the signal is obscured by seat or CRS (for example, child is restrained in the forward-facing CRS).
- Movement is detected in areas other than the rear seats.
- The rear passenger is covered with a fabric containing metallic substance such as a blanket.
- An object in the vehicle blocks the sensor.
- The sensor is contaminated by foreign material.
- An animal at the rear seat or luggage compartment is not large enough to be detected by the sensor or there is hardly any movement.
- Attaching objects or modifying the interior ceiling, or the interior ceiling is deformed or damaged.
- There are electronic interference around the vehicle.
- Other environmental reasons that may affect the system.

## Declaration of Conformity

The radio frequency components (ROA Radar Sensor) complies:

- For Europe and CE certified countries

Declaration of Conformity  
Radiocontrolled Vehicle components



We, IEE International Electronics & Engineering, abbreviated "IEE S.A.", a Luxembourg société anonyme, having its registered office at Zone Industrielle, 12 rue Pierre Richardot, L-6468 Echternach, Grand-Duchy of Luxembourg and registered with the Luxembourg Trade and Companies' Register under number B 134858, declare under our sole responsibility that the above named product is in conformity with the relevant Union harmonisation legislation:

- 2011/65/EU - European RoHS Directive
- 2014/53/EU - Radio Equipment Directive

The original declaration of conformity can be consulted at: IEE S.A., Legal Department, 1 rue du Campus, L-7795 Bissen, Luxembourg.

frequency band 60-64 GHz  
Maximum Output Power 13 dBm (20 mW)

OANATEL402

## INTEGRATED MEMORY SYSTEM



Integrated Memory System for the driver's seat is provided to store and recall the following memory settings with a simple button operation.

- Driver's seat position
- Steering wheel position (power adjustment)
- Outside rearview mirror position
- Head-Up Display (HUD) position (if equipped)



### WARNING

**Never attempt to operate the integrated memory system while the vehicle is moving.**

**This could result in loss of control, and an accident causing death, serious injury, or property damage.**

### Information

- **If the battery is disconnected, the memory settings will be erased.**
- **If integrated memory system does not operate normally, we recommend that you have the system inspected by an authorized retailer of Genesis Branded products.**

### Storing memory positions

1. Shift to P (Park) while the Start/Stop button is in the ON position.
2. Adjust the driver's seat position, outside rearview mirror position, steering wheel position and head-up display height to the desired position.
3. Press the SET button. The system will beep once and notify you 'Press button to save settings' on the cluster LCD display.
4. Press one of the memory buttons (1 or 2) within 4 seconds. The system will beep twice when the memory has been successfully stored.
5. 'Driver 1 (or 2) settings saved' will appear on the cluster LCD display. The message appears only for the driver's seat position memory setting.

## Recalling memory positions

1. Shift to P (Park) while the Start/Stop button is in the ON position.
2. Press the desired memory button (1 or 2). The system will beep once, and then the driver's seat position, outside rearview mirror position, steering wheel position and head-up display height will automatically adjust to the stored positions.
3. 'Driver 1 (or 2) settings applied' will appear on the cluster LCD display.

### Information

- **If you press the SET button or the corresponding button which the setting is being recalled, the setting will temporarily deactivate. If you press the other buttons, the setting of the pressed button will activate.**

**For example, if you press the SET button or number 1 button with the number 1 setting in operation, the setting will temporarily deactivate. If you press the number 2 button, the number 2 setting will activate.**

- **If you adjust the seat, rearview mirror, steering wheel or head-up display while recalling the stored positions, the pre-set settings will become ineffective.**

## Resetting the system

Take the following procedures to reset integrated memory system, when it does not operate properly.

### *Resetting integrated memory system*

1. Stop the vehicle and open the driver's door with the Start/Stop button in the ON position and the vehicle shifted to P (Park).
2. Adjust the driver's seat and seatback to the foremost position.
3. Press the SET button and push forward the driver's seat movement switch over 2 seconds simultaneously.

### *While resetting integrated memory system*

1. Resetting starts with a notification sound.
2. The driver's seat and seatback is adjusted to the rearward position with the notification sound.
3. The driver's seat and seatback is re-adjusted to the default position (central position) with the notification sound.

However, in the following cases, the resetting procedure and the notification sound may stop.

- The memory button is pressed.
- The seat control switch is operated.
- The gear is shifted out of P (Park).
- The driving speed exceeds 3 km/h (2 mph).
- The driver's door is closed.

**NOTICE**

- **While integrated memory system is being reset, if the resetting and notification sound stops incompletely, restart the resetting procedure again.**
- **Make sure that there is no objects around the driver's seat in advance of resetting the integrated memory system.**
- **After resetting the integrated memory system, the adjustment for the driver seat must be stored again to recall the memory position.**

**Seat easy access**

Seat easy access will move the driver's seat and steering wheel automatically as follows:

- **Exiting the vehicle:**  
The driver's seat, steering wheel and seat bolster will move as follows when the Start/Stop button is in the OFF position with the gear in P (Park) and the driver's door open.
  - Driver seat: Moves rearward depending on the distance selected from the Settings menu in the infotainment system.
  - Steering wheel: Moves upward
  - Seat bolster (if equipped): Adjusted to the default position.

However, the driver's seat may not move rearward if there is not enough space between the driver's seat and the rear seats.

Also, on a regular basis, the steering wheel will also move forward to adjust its location by itself.

- **Entering the vehicle:**  
The driver's seat, steering wheel and seat bolster will move as follows when the Start/Stop button is pressed to the ACC, ON or START position or while carrying the smart key, the driver's door is closed with the Start/Stop button in the OFF position.
  - Driver seat: Moves back to its original position.
  - Steering wheel: Moves back to its original position.
  - Seat bolster (if equipped): Adjusted to the default position.
- You can set the Seat Easy Access function from the Settings menu in the infotainment system screen. Select:
  - Driver seat  
Setup → Vehicle Settings → Seat → Seating Easy Access → Driver Seat Easy Access → Normal/Extended/Off
  - Steering wheel  
Setup → Vehicle Settings → Seat → Seating Easy Access → Steering wheel easy access

For detailed information, scan the QR code in the separately supplied simple manual.



## STEERING WHEEL

### MDPS (Motor Driven Power Steering)

The system assists you with steering the vehicle. If the vehicle is turned off or if the power steering system becomes inoperative, you may still steer the vehicle, but it will require increased steering effort.

Should you notice any change in the effort required to steer during normal vehicle operation, we recommend that you have the system checked by an authorized retailer of Genesis Branded products.



### CAUTION

If MDPS (Motor Driven Power Steering) does not operate normally, the  warning light and the message 'Check motor driven power steering' will illuminate on the instrument cluster. You may steer the vehicle, but it will require increased steering efforts. We recommend that you take the vehicle to an authorized retailer of Genesis Branded products and have the system checked as soon as possible.

### Information

The following symptoms may occur during normal vehicle operation:

- **The steering effort may be high immediately after pressing the Start/Stop button to the ON position.**  
This happens as the system performs the MDPS system diagnostics. When the diagnostics are completed, the steering wheel effort will return to its normal condition.
- **When the battery voltage is low, you might have to put more steering effort.** However, it is a temporary condition so that it will return to normal condition after charging the battery.
- **A click noise may be heard from the MDPS relay after the Start/Stop button is in the ON or OFF position.**
- **Motor noise may be heard when the vehicle is at a stop or at a low driving speed.**
- **When you operate the steering wheel in low temperatures, abnormal noise may occur.** If the temperature rises, the noise will disappear. This is a normal condition.
- **When an error is detected from MDPS, the steering effort assist function will not be activated in order to prevent fatal accidents.** Instrument cluster warning lights may be on or the steering effort may be high. If these symptoms occur, drive the vehicle to a safe area as soon as it is safe to do so. We recommend that you have the system checked by an authorized retailer of Genesis Branded products as soon as possible.

### Tilt/Telescopic steering

When adjusting the steering wheel to a comfortable position, adjust the steering wheel so that it points toward your chest, not toward your face. Make sure you can see the instrument cluster warning lights and gauges. After adjusting, push the steering wheel both up and down to be certain it is locked in position.

Always adjust the position of the steering wheel before driving.

#### **WARNING**

**NEVER** adjust the steering wheel while driving. This may cause loss of vehicle control resulting in an accident.

#### *Manual adjustment (if equipped)*



To adjust the steering wheel angle and height:

1. Pull down the lock-release lever (1).
2. Adjust the steering wheel to the desired angle (2) and distance forward/back (3).
3. Pull up the lock-release lever to lock the steering wheel in place.

#### **Information**

Sometimes the lock release lever may not engage completely. This may occur when the gears of the locking mechanism do not completely mesh. If this occurs, pull down on the lock-release lever, readjust the steering wheel again, and then pull back up on the release lever to lock the steering wheel in place.

#### *Power adjustment (if equipped)*



To change the steering wheel angle and height:

- Push the switch (1) up and down to adjust the angle (2).
- Push the switch (1) forward or rearward to adjust the height (3).

#### **NOTICE**

**Do not adjust the steering wheel longer than necessary when the vehicle is turned off (READY indicator off). This may result in unnecessary battery drain.**

### ***Resetting steering wheel power adjustment***

If adjustment is no longer possible within the operable range while adjusting the steering wheel position (angle or height), reset as follows.

1. From the position the steering wheel has stopped, push the control switch (1) for 10 seconds in the direction you were adjusting the steering wheel. The steering wheel will move in the direction the control switch is pushed.
2. Continue pushing the switch (1) for at least 2 seconds after the steering wheel has stopped. Resetting will be complete after the operational range is recognized.

If the adjustment is still not possible after resetting the steering wheel power adjustment, we recommend that the system be inspected by authorized retailer of Genesis Branded products.

### **Horn**



To sound the horn, press the area indicated by the horn symbol on your steering wheel (see illustration). The horn will operate only when this area is pressed.

### **NOTICE**

**Do not strike the horn severely to operate it, or hit it with your fist. Do not press on the horn with a sharp-pointed object.**

## Heated steering wheel (if equipped)



While the READY indicator is on touch the heated steering wheel icon to warm the steering wheel.

### Manually adjusting temperature

Each time you press the heated steering icon, the temperature changes as follows.

- OFF → HIGH → LOW
- Pressing the icon when temperature is low, the heated steering wheel will turn off.

### Automatically adjusting temperature

- When HIGH is manually selected, the heated steering wheel automatically changes to the LOW position after 30 minutes. You can turn off the heated steering wheel by pressing the icon to the OFF position.
- When LOW is manually selected, the heated steering wheel will not be controlled manually.

### Automatic Controls Linked to Climate Control Settings

The heated steering wheel automatically controls the steering wheel temperature depending on the ambient temperature when READY indicator is on.

To use this feature, it must be enabled from the Settings menu in the infotainment system screen.

Select:

- Setup → Vehicle → Seat → Warmer/Ventilation Features → Auto. Controls That Use Climate Control Settings → Heated steering wheel  
For detailed information, scan the QR code in the separately supplied simple manual.
- If you press the heated steering wheel icon when the feature is set, you must control the heated steering wheel manually.
- The heated steering wheel defaults to the OFF position whenever the Start/Stop button is pressed to the ON position. However, if the Automatic Controls Linked to Climate Control Settings feature is ON, the heated steering wheel will turn on and off depending on the outside temperature.

**NOTICE**

- Do not install any cover or accessory on the steering wheel. The cover or accessory could cause damage to the heated steering wheel system.
- Do not strike the steering wheel grip surface with sharp objects. It may damage the heating element in the steering wheel.
- Do not clean the steering wheel surface using the following products. Heater and steering wheel surfaces may be damaged.
  - Organic solvents such as thinner, alcohol and gasoline
  - Chemical products such as leather cleaner, coating agent, and wax

## MIRRORS

### Inside rearview mirror

Before driving your vehicle, check to see that your inside rearview mirror is properly positioned. Adjust the rearview mirror so that the view through the rear window is properly centered.

#### WARNING

**Make sure your line of sight is not obstructed. Do not place objects in the rear seat, cargo area, or behind the rear headrests which could interfere with your vision through the rear window.**

#### WARNING

**To prevent serious injury during an accident or deployment of the air bag, do not modify the rearview mirror and do not install a wide mirror.**

#### WARNING

**NEVER adjust the mirror while driving. This may cause loss of vehicle control resulting in an accident.**

#### **NOTICE**

**When cleaning the mirror, use a paper towel or similar material dampened with glass cleaner. Do not spray glass cleaner directly on the mirror as this may cause the liquid cleaner to enter the mirror housing.**

### *Electric Chromic Mirror (ECM)*



[A]: Indicator

Some vehicles come equipped with an electrochromic mirror that helps control glare while driving at night or under low light driving conditions.

When the READY indicator is on, the glare is automatically controlled by the sensor mounted in the rearview mirror. The sensor detects the light level around the vehicle, and automatically adjusts to control the headlamp glare from vehicles behind you.

Whenever the the gear is shifted to R (Reverse), the mirror will automatically go to the brightest setting in order to improve the driver's view behind the vehicle.

## Outside rearview mirrors



Your vehicle is equipped with both left-hand and right-hand outside rearview mirrors. The mirrors can be adjusted remotely with the mirror adjustment control switch. The outside rearview mirrors can be folded to help prevent damage when going through an automatic car wash or when passing through a narrow street.

The left and right outside rearview mirrors are convex. Objects seen in the mirror are closer than they appear.

Use the inside rear view mirror or look back directly to determine the actual distance of other vehicles prior to changing lanes.

Make sure to adjust the outside rearview mirrors to your desired position before you begin driving.



### WARNING

Do not adjust or fold the outside rearview mirrors while driving. This may cause loss of vehicle control resulting in an accident.

### NOTICE

- Do not scrape ice off the mirror face; this may damage the surface of the glass.
- If the mirror is jammed with ice, do not adjust the mirror by force. Use an approved de-icer (not radiator antifreeze) spray, or a sponge or soft cloth with very warm water, or move the vehicle to a warm place and allow the ice to melt.
- Do not clean the mirror with harsh abrasives, fuel or other petroleum based cleaning products.

### Adjusting the rearview mirrors

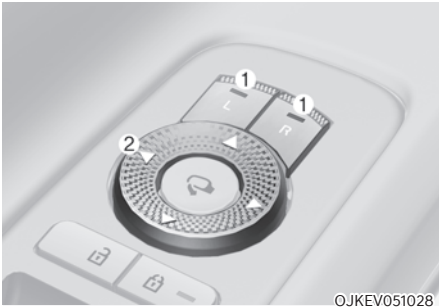

Adjusting the rearview mirrors:

1. When the START/STOP button is in the ACC, ON or START position, press either the L (Left side) or R (Right side) button (1) to select the rearview mirror you would like to adjust.
2. Use the mirror adjustment control switch (2) to position the selected mirror up, down, left or right.
3. After adjustment, press both L and R button off (indicator light off) to prevent inadvertent adjustment.

#### **NOTICE**

- **The mirrors stop moving when they reach the maximum adjusting angles, but the motor continues to operate while the switch is pressed. Do not press the switch longer than necessary, because this can damage the motor.**
- **Do not attempt to adjust the rearview mirrors by hand, because this can damage the motor.**

### Folding the rearview mirrors



The rearview mirrors can be folded or unfolded by pressing the button.

#### **Infotainment system setting**

- Enable on door unlock  
If 'Setup → Vehicle Settings → Welcome Mirror/Light → Enable on Door Unlock' is selected from the Settings menu in the infotainment system screen,
  - The mirror will fold or unfold when the door is locked or unlocked by the smart key.
  - The mirror will fold or unfold when the door is locked or unlocked by the touch sensor on the outside door handle.
- Enable on driver approach  
If 'Setup → Vehicle Settings → Lights → Welcome Mirror/Light → Enable on Driver Approach' is selected from the Settings menu in the infotainment system screen, the mirror will unfold when the vehicle is approached with the smart key in possession.

For detailed information, scan the QR code in the separately supplied simple manual.



**NOTICE**

- The electric type outside rearview mirror operates even though the Start/Stop button is in the OFF position. However, to prevent unnecessary battery discharge, do not adjust the mirrors longer than necessary while the READY indicator is off.
- Do not fold the electric type outside rearview mirror by hand. It could cause motor failure.

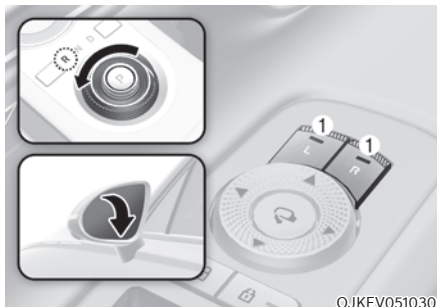
**Reverse parking aid (if equipped)**

When the gear is shifted to the R (Reverse) position, the outside rearview mirror(s) will rotate downwards to aid with driving in reverse.

The position of the outside rearview mirror button (1) determines whether or not the mirrors will move:

How it works

- When the L or R button (1) is pressed (indicator lights ON), both outside rearview mirrors will move.
- If the L and R buttons (1) are not pressed (indicator lights OFF), both outside rearview mirrors will not move.

The outside rearview mirrors will automatically revert to their original positions if any of the following occur:

- The Start/Stop button is pressed to either the OFF position or the ACC position.
- The gear is shifted to any position except R (Reverse).
- The outside rearview mirror adjustment button is not selected.

### ***Reverse parking aid user settings mode***

You may change the angle of the outside rearview mirror if it is difficult to see the rear view with the basic downward mirror angle provided when reversing.

When the vehicle is first delivered, the set downward angle of the left and right outside rearview mirror are different to ensure driver visibility.

1. Make sure the vehicle is stopped.
2. Depress the brake pedal and shift the gear to R (Reverse). When L (Left) or R (Right) button is pressed, both outside rearview mirror angle will move downward to the basic set position.
3. Press either L or R button to select the outside rearview mirror you would like to adjust. Then press “▼, ▲, ◀, ▶” switch to adjust the outside rearview mirror to the desired angle.
4. After adjusting the angle to save the adjusted outside rearview mirror angle, shift the gear to another position other than R (Reverse), or change the L and R buttons to the neutral position (L and R buttons are not pressed).
5. Set the opposite outside rearview mirror following the above procedure 1 to 4.

### **Resetting reverse parking aid user settings mode**

To change the outside rearview mirror angle back to the basic angle, shift the gear to R (Reverse), and adjust the mirror angle higher than when the gear is in P (Park), N (Neutral) and D (Drive).

#### **NOTICE**

**When changing the angle of both outside rearview mirrors, it is recommended to change the angle one side at a time following the procedure 1 to 4.**

## WINDOWS

### Left-hand drive

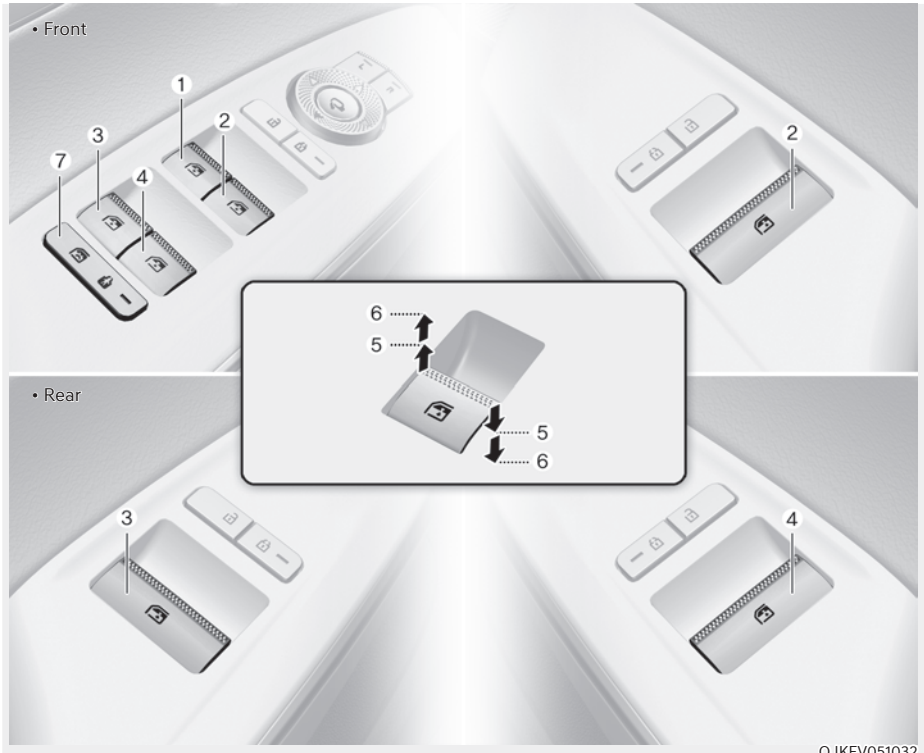

- |  |   |
|--|---|
| (1) Driver's door power window switch          | (4) Rear door (right) power window switch |
| (2) Front passenger's door power window switch | (5) Window opening and closing            |
| (3) Rear door (left) power window switch       | (6) Automatic power window                |
|  | (7) Power window lock switch              |

Right-hand drive

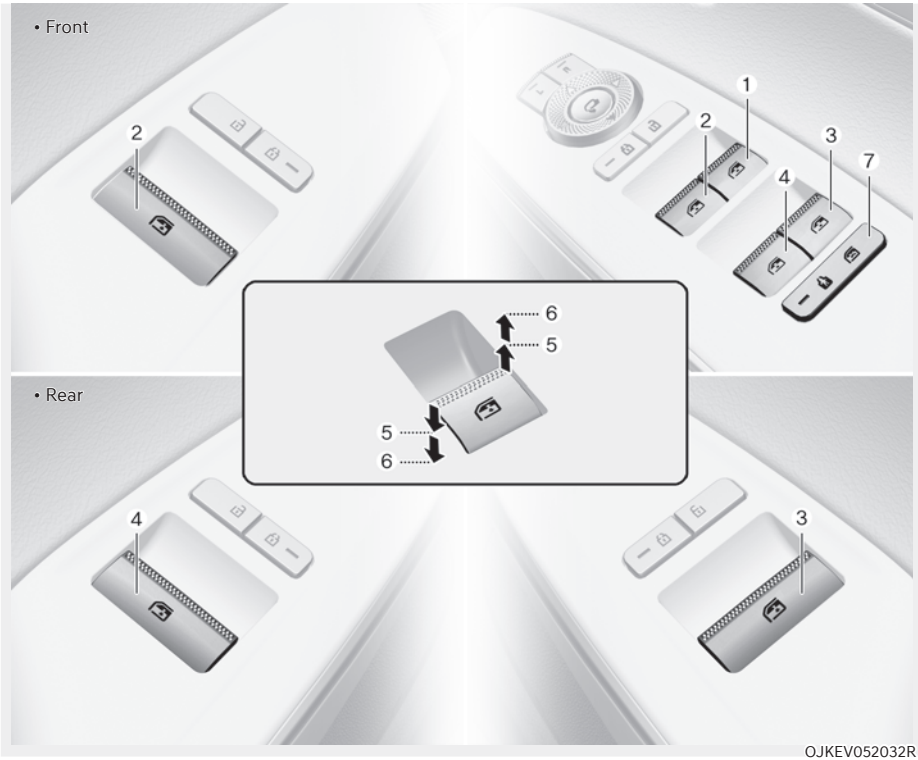

OJKEV052032R

- (1) Driver's door power window switch
- (2) Front passenger's door power window switch
- (3) Rear door (right) power window switch
- (4) Rear door (left) power window switch
- (5) Window opening and closing
- (6) Automatic power window
- (7) Power window lock switch

## Power windows

The Start/Stop button must be in the ON position to be able to raise or lower the windows. Each door has a Power Window switch to control that door's window. The driver has a Power Window Lock button which can block the operation of rear passenger windows. The power windows will operate for approximately 3 minutes after the Start/Stop button is in the ACC or OFF position. However, if the front doors are opened, the Power Windows will not operate even within the 3 minute period.

### Window opening and closing

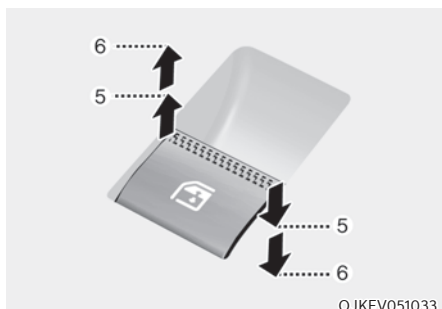

To open:

Press the window switch down to the first detent position (5). Release the switch when you want the window to stop.

To close:

Pull the window switch up to the first detent position (5). Release the window switch when you want the window to stop.

### Auto up/down window

Pressing or pulling up the power window switch momentarily to the second detent position (6) completely lowers or lifts the window even when the switch is released. To stop the window at the desired position while the window is in operation, pull up or press down and release the switch.

#### WARNING

- Do not leave the READY indicator on and the key in your vehicle with unsupervised children. Unattended children could operate the window, which could result in serious injury.
- Do not extend your head, arms or any other body parts or objects outside the window while driving to avoid serious injury.

### Resetting the power windows

If the power windows do not operate normally, the automatic power window system must be reset as follows:

1. Press the Start/Stop button to the ON position.
2. Close the window and continue pulling up on the power window switch for at least one second.

If the power windows do not operate properly after resetting, we recommend that the system be inspected by an authorized retailer of Genesis Branded products.

#### WARNING

**The automatic reverse feature doesn't activate while resetting the power window system.**

**Make sure body parts or other objects are safely out of the way before closing the windows to avoid injuries or vehicle damage.**

### Automatic reverse

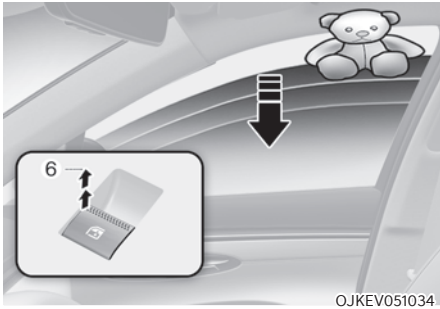

If a window senses any obstacle while it is closing automatically, it will stop and lower approximately 30 cm (12 in.) to allow the object to be cleared.

If the window detects the resistance while the power window switch is pulled up continuously, the window will stop upward movement then lower approximately 2.5 cm (1 in.).

If the power window switch is pulled up continuously again within 5 seconds after the window is lowered by the automatic window reverse feature, the automatic window reverse will not operate.

### **i** Information

**The automatic reverse feature is only active when the “Auto Up” feature is used by fully pulling up the switch to the second detent.**

### **⚠** WARNING

**Make sure body parts or other objects are safely out of the way before closing the windows to avoid injuries or vehicle damage.**

**Objects less than 4 mm (0.16 in.) in diameter caught between the window glass and the upper window channel may not be detected by the automatic reverse window and the window will not stop and reverse direction.**

### Power window lock button



The driver can disable the power window switches on the rear passenger doors by pressing the power window lock button. When the power window lock button is pressed:

- The rear passenger control will not be able to operate the rear passenger power window.
- Note that the front passenger control is still able to operate the front passenger window, and that the driver master control can still operate all the power windows.

### **WARNING**

Do not allow children to play with the power windows. Keep the driver's door power window lock button in the LOCK position. Serious injury or death can result from unintentional window operation by a child.

### **NOTICE**

- To prevent possible damage to the power window system, do not open or close two windows or more at the same time. This will also ensure the longevity of the fuse.
- Never try to operate the main switch on the driver's door and the individual door window switch in opposite directions at the same time. If this is done, the window will stop and cannot be opened or closed.

### *Remote window open/close feature (Remote Window Control)*

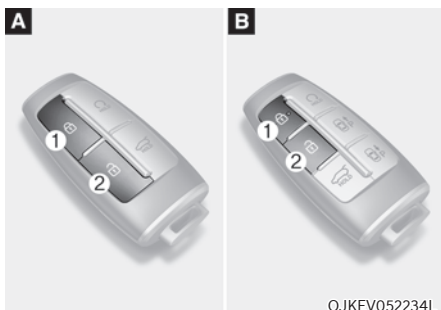

You can still control the window movement with the vehicle turned off by pressing the Door Lock button (1) or the Door Unlock button (2).

- Press the door lock button for more than 3 seconds. The doors will lock and the windows will move up as long as you press the door lock button.
- Press the door unlock button for more than 3 seconds. The doors will unlock and the windows will move down as long as you press the door unlock button.

### **Information**

- The remote window opening/closing function may abruptly stop when you move away from your vehicle during operation. Stay in close proximity from your vehicle, while monitoring the window movement.
- One of the windows may stop operating when the window is interrupted by certain force. However, the other windows will keep operating. Make sure that all windows are closed.
- Please be aware that the doors unlock when the windows are opened using the remote window open/closing function.

### **WARNING**

Always double check to make sure arms, hands, head and other obstructions are safely out of the way before using remote window closing function.

## PANORAMA SUNROOF (IF EQUIPPED)

If your vehicle is equipped with a sunroof, you can slide or tilt your sunroof with the sunroof switch located on the overhead console.



The sunroof can only be operated when the Start/Stop button is in the ON or START position.

The sunroof can be operated for approximately 3 minutes after the Start/Stop button is in the ACC or OFF position. However, if the front door is open, the sunroof cannot be operated even within the 3minute period.



### WARNING

- **Adjust the sunroof or sunshade when your vehicle stops. This could result in loss of control and an accident that may cause injury, or property damage.**
- **Do not leave the vehicle running and the key in your vehicle with unsupervised children. Unattended children could operate the sunroof, which could result in serious injury.**
- **Do not sit on the top of the vehicle. It may cause injury or vehicle damage.**

### NOTICE

**Do not operate the sunroof when roof bars are installed on the vehicle or when there is luggage on the roof.**

## Power sunshade



Use the power sunshade to block direct sunlight coming through the sunroof glass.

- Push the sunroof switch rearward to the first detent position, the power sunshade automatically slides open.
- Push the sunroof switch forward to the first detent position, the power sunshade automatically closes. However, if the sunroof glass is open, the glass will close first.

To stop the power sunshade at any point, push the sunroof switch in any direction.

### NOTICE

**Do not pull or push the power sunshade by hand as such action may damage the power sunshade or cause it to malfunction.**



### Information

Wrinkles formed on the power sunshade are normal due to material characteristic.



### Tilt open/close

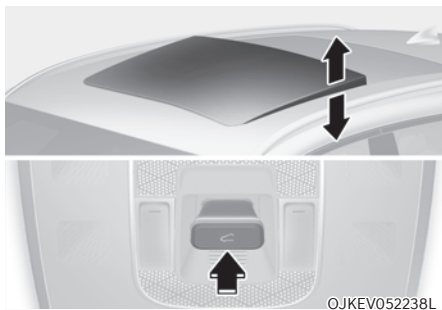

- Push the sunroof switch upward, the sunroof glass tilts open. However, if the power sunshade is closed, the sunshade will open first.
- Push the sunroof switch upward or forward when the sunroof glass is tilt opened, the sunroof glass automatically closes.

To stop the sunroof movement at any point, push the sunroof switch in any direction.

### Slide open/close



- Push the sunroof switch rearward to the first detent position, the sunroof glass opens. However, if the power sunshade is closed, the power sunshade will open first.

Push the sunroof switch forward to the first detent position, the sunroof glass closes. However, if the sunroof glass is closed, the power sunshade will close.

- Push the sunroof switch forward or rearward to the second detent position, the power sunshade and sunroof glass operate automatically (auto slide feature).

To stop the sunroof movement at any point, push the sunroof switch in any direction.

## Automatic reversal

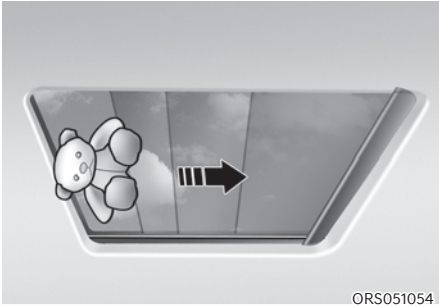

If the power sunshade or sunroof glass senses any obstacle while it is closing automatically, it will reverse direction then stop at a certain position.

The auto reverse function may not work if an object thin or soft is caught between the sliding power sunshade or sunroof glass and sunroof sash.

### WARNING

- **Make sure heads, hands, arms or any other body parts or objects are out of the way before operating the sunroof. Body parts or objects may get caught causing injuries or vehicle damage.**
- **Never deliberately use your body parts to test the automatic reversal function. The power sunshade or sunroof glass may reverse direction, but there is a risk of injury.**

### **NOTICE**

- **Do not continue to push the sunroof switch after the sunroof is fully opened, closed, or tilted. Damage to the sunroof motor could occur.**
- **Continuous operations such as slide open/close, tilt open/close, etc. may cause the motor or sunroof system to malfunction.**
- **Regularly remove any accumulated dust on the sunroof rail.**
- **Dust accumulated between the sunroof and roof panel can make noise. Open the sunroof and remove dust regularly using a clean cloth.**
- **Do not try to open the sunroof when the temperature is below freezing or when the sunroof is covered with snow or ice. The sunroof may not work properly and may break if opened by force.**
- **Do not open or drive with the sunroof glass open immediately after rain or washing the vehicle. Water may wet the interior of the vehicle.**
- **Do not extend any luggage outside the sunroof while driving. Vehicle damage may occur if the vehicle suddenly stops.**

### WARNING

**Do not extend your head, arms, body parts or objects outside the sunroof while driving. Injuries may occur if the vehicle suddenly stops.**

## Resetting the sunroof



In some circumstances resetting the sunroof operation may need to be performed. Some instances where resetting the sunroof may be required include:

- When the 12-volt battery is either disconnected or discharged
- When the sunroof fuse is replaced
- If the sunroof one-touch AUTO OPEN/CLOSE operation is not functioning properly

Sunroof resetting procedure:

1. It is recommended to perform the reset procedure with the vehicle running. Start the vehicle in P (Park).
2. Make sure the power sunshade and sunroof glass are in the fully closed position. If the power sunshade and sunroof glass are open, push the switch forward until the power sunshade and sunroof glass are fully closed.

3. Release the switch when the power sunshade and sunroof glass are fully closed.
4. Push the switch forward until the power sunshade and sunroof glass move slightly. Then release the switch.
5. Once again push and hold the sunroof switch forward until the power sunshade and sunroof glass slide open and close. Do not release the switch until the operation is completed. If you release the switch during operation, start the procedure again from step 2.

### Information

**If the sunroof does not reset when the vehicle battery is disconnected or discharged, or the sunroof fuse is blown, the sunroof may not operate normally.**

### Sunroof open warning

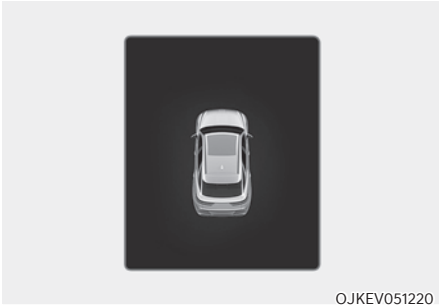

If the driver turns off the vehicle when the sunroof is not fully closed, the warning chime will sound for several seconds and the sunroof open warning will appear on the cluster LCD display. Close the sunroof securely when leaving your vehicle.

#### CAUTION

**Make sure the sunroof is closed fully when leaving your vehicle.**  
**If the sunroof is left open, rain or snow may wet the interior of the vehicle.**  
**Also, leaving the sunroof open when the vehicle is unattended may invite theft.**

## EXTERIOR FEATURES

### Hood Opening the hood

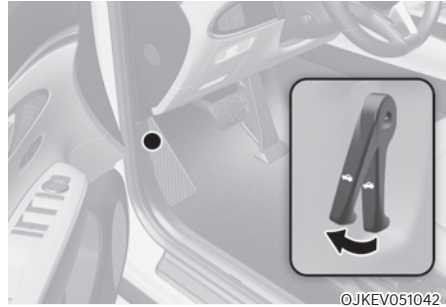

1. Park the vehicle and set the parking brake.
2. Pull the release lever to unlatch the hood. The hood should pop open slightly.

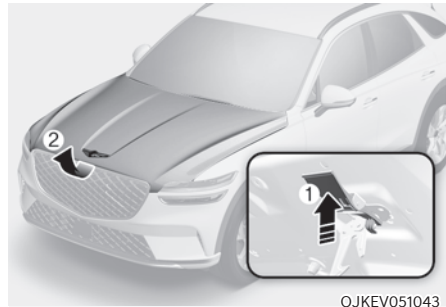

3. Go to the front of the vehicle, raise the hood slightly, push up the secondary latch (1) inside of the hood center and lift the hood (2).  
After the hood has been lifted halfway, it will raise completely by itself.

### ***Closing the hood***

1. Before closing the hood, check in and around the vehicle compartment to ensure the following:
  - Any tools or other loose objects are removed from the motor compartment area or hood opening area
  - All glove, rags, or other combustible material is removed from the motor compartment
  - All filler caps are tightly and correctly installed
2. Lower the hood halfway (lifted approximately 30 cm (12 in.) from the closed position) and push down to securely lock in place. Then double check to be sure the hood is secure. If the hood can be raised slightly, it is not securely locked. Open it again and close it with more force.



### **WARNING**

- Before closing the hood, ensure all obstructions are removed from around the hood opening.
- Always double check to be sure that the hood is firmly latched before driving away. Check there is no hood open warning light or message displayed on the instrument cluster. Driving with the hood opened may cause a total loss of visibility, which might result in an accident.
- Do not move the vehicle with the hood in the raised position, as vision is obstructed, which might result in an accident, and the hood could fall or be damaged.

### **Front trunk**

#### ***Opening the front trunk***

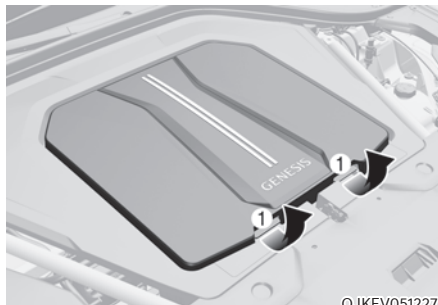

- Open the hood
- Lift up the front trunk cover while depressing the front trunk lever (1).

#### ***Closing the front trunk***

Push down the front trunk cover to the right position.



### **Information**

Available front trunk weight

- 4WD : 12 kg (26 lbs)

Available front trunk weight depends on the specifications.



### **WARNING**

- **NEVER** make an attempt to get inside the front trunk. It will cause a fatal injury.
- Before closing the hood, ensure all obstructions are removed from around the hood opening. The hood will rise up or move down automatically if the height is not firmly adjusted. Be aware of the damage caused by the unintended hood movements.
- Never store cigarette lighters, propane cylinders, or other flammable/explosive materials in the vehicle. These items may catch fire and/or explode if the vehicle is exposed to hot temperatures for extended periods.



### **CAUTION**

- Do not exceed the luggage volume capacity of the front trunk. The overweighted front trunk can be severely damaged.
- Do not store the fragile objects in the front trunk.
- **ALWAYS** keep the front trunk cover closed securely while driving. Items inside your vehicle are moving as fast as the vehicle. If you have to stop or turn quickly, or if there is a crash, the items can be damaged.

- Do not spray water in the front trunk. Vehicle driving system may get damaged since the front trunk is located at the center of motor compartment.
- Be careful when you store any liquid in the front trunk. If liquid leak outside the front trunk, it will cause a damage to the electric devices in the motor compartment.
- Do not press the front trunk cover or place the objects on the front trunk cover. It may be deformed or damaged.
- When closing the front trunk cover, be careful not to touch objects inside the trunk. Loaded objects or the front trunk may be deformed or damaged and the front trunk cover may be opened during driving due to poor closing, resulting in joints and damage.

### **NOTICE**

To avoid possible theft, do not leave valuables in the storage compartments.

## Power tailgate (IF EQUIPPED)

### *Power tailgate operating conditions*

The power tailgate operates when the gear is in P (Park) with the READY indicator on. However, the power tailgate will operate regardless of the gear position when the READY indicator is off. Also, the tailgate can be opened only when vehicle speed is below 3 km/h (1.8 mph).

For safety, before attempting to open or close the tailgate, make sure the vehicle is in P (Park).



### WARNING

- **Never leave children or animals unattended in your vehicle. Children may operate the power tailgate. Doing so can result in injury to themselves or others and can damage the vehicle.**

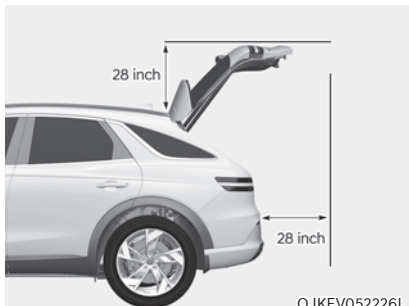

OJKEV052226L

**Make sure that there are no people or objects in the path of the power tailgate or smart tailgate prior to use. Serious injury, damage to the vehicle or damage to surrounding objects (for example, walls, ceilings, vehicles, etc.) may result if contact with the tailgate occurs.**

### NOTICE

- **Do not close or open the tailgate manually. This may cause damage to the power tailgate. If it is necessary to close or open the tailgate manually when the battery is discharged or disconnected, do not apply excessive force.**
- **Do not operate the power tailgate more than 10 times continuously when the READY indicator is off. Use the power tailgate with the READY indicator on when the power tailgate is used repeatedly to prevent battery discharge.**
- **Do not leave the power tailgate open for a long period of time. This may drain the battery.**
- **Do not apply excessive force when the power tailgate is operating. Doing so could result in vehicle damage.**



OJKEV051225

**Do not grab or hold on to the tailgate support struts at any time. Damage to the tailgate support struts could result. Deformation of the tailgate support struts may cause vehicle damage and personal injury may occur.**

- **Do not modify or repair any part of the power tailgate by yourself. We recommend that you have the vehicle inspected by an authorized retailer of Genesis Branded products. Do not operate the power tailgate under the following conditions. The power tailgate may not operate properly.**
  - One side of the vehicle is lifted to inspect the vehicle or change a tire
  - Parking on an uneven road such as a slope, etc.
- **Close the tailgate completely and lock all doors and tailgate using the central door lock button before using an automatic car wash.**
- **Do not spray high pressure water directly on the power tailgate outside open/close button. The tailgate may open unintentionally.**

### **i** Information

- **If the tailgate is not fully closed and vehicle speed is at or above 3 km/h (1.8 mph), a warning will sound 10 times. Immediately park the vehicle at a safe place, close the tailgate, and check that the tailgate open warning on the instrument cluster is turned off.**
- **In cold and wet climates, the outside power tailgate open/close button may not work properly due to freezing conditions. If this occurs, remove the ice before using the outside power tailgate open/close button or use the power tailgate open/close button on the smart key or the instrument panel.**
- **Operating the power tailgate more than 5 times continuously could cause damage to the operating motor. If this occurs, the power tailgate will not operate to prevent the motor from overheating. If any of the power tailgate buttons are pressed to try to open the tailgate, the chime will sound 3 times, but the tailgate will remain closed. Allow the power tailgate system to cool for about 1 minute before operating the system again.**



### Operating the power tailgate

Power tailgate open/close button (Smart key, Instrument panel)



Press the power tailgate open/close button for 1 second. The tailgate opens or closes with a warning sound.

While the tailgate is opening or closing, press the button to stop tailgate operation.

If the smart key is not within operation range (approximately 10 m) from the vehicle, tailgate operation will stop with a warning sound for 5 seconds.

Power tailgate open/close button (Outside the power tailgate)



When the tailgate is closed, press the power tailgate open/close button to open the tailgate.

If the vehicle is locked, press the power tailgate open/close button with the smart key in your possession.

If the tailgate is unlocked, the tailgate will open or close with a warning sound when the power tailgate open/close button is pressed without carrying the smart key.

**Power tailgate open/close button (Inside the power tailgate)**



Press the power tailgate open/close button. The tailgate opens or closes with a warning sound.

**Power tailgate lock button (Inside the power tailgate)**



Press the power tailgate lock button while carrying the smart key. The tailgate closes and locks with a warning sound. Additionally, all doors will lock.

The tailgate can be closed and locked, and all doors locked only when the button is pressed while the READY indicator is off.

**Automatic reverse**

During power tailgate operation if the power tailgate senses any obstacle, the tailgate will stop or will fully open. The automatic reverse feature may not operate properly, or it may operate unexpectedly under the following circumstances:

- The automatic reverse feature may not detect the resistance if the detected resistance is below a certain level, or if the tailgate is almost fully closed near the latched position.
- The automatic reverse feature may operate if a strong impact is applied with no obstructions placed.

**⚠ WARNING**

**Never intentionally place any object or part of your body in the path of the power tailgate to make sure the automatic reverse feature operates. Serious injury, or damage to the vehicle or object may occur.**

**i Information**

**The power tailgate may stop operating if the automatic reverse feature operates more than two times while attempting to open or close the tailgate. If this occurs, carefully open or close the tailgate manually, and then after 30 seconds try to operate the power tailgate automatically again.**

### **Setting the power tailgate**

To use each feature, you must select the opening speed or opening height from the settings menu. Deselect the settings when you do not want to use the feature.

#### **Power tailgate opening speed**

To adjust the power tailgate speed, select 'Setup → Vehicle Settings → Door/Tailgate → Power Tailgate Opening Speed → Fast/Slow' in the infotainment system. (Default setting is 'Fast'.)

#### **Power tailgate opening height**

To adjust the power tailgate opening height, select 'Setup → Vehicle Settings → Door/Tailgate → Power Tailgate Opening Height → Full Open/Level 3/Level 2/Level 1/User Height Setting' in the infotainment system.

The infotainment system may change after updates. For detailed information on system settings, scan the QR code in the manual supplied separately.

#### **User height setting**

1. Position the tailgate manually to the height you prefer.
2. Press the power tailgate open/close button located inside the tailgate for more than 3 seconds.
3. If 'User Height Setting' is selected for the power tailgate opening height, the power tailgate will automatically open to the height manually set by you.

#### **Information**

**If the power tailgate opening height has not been manually set, the power tailgate will fully open when 'User Height Setting' from the infotainment system is selected.**

**If one of the height setting (Full Open/Level 3/Level 2/Level 1) is selected from the settings menu in the infotainment system, and then 'User Height Setting' is selected, the tailgate will open to the height manually set by you.**

**The power tailgate opening speed and opening height settings change according to the linked User Profile. If the User Profile is changed, power tailgate opening speed and opening height settings will change accordingly.**

### Resetting the power tailgate

In some circumstances resetting the power tailgate operation may need to be performed. Some instances where resetting the power tailgate may be required include:

- When the 12-volt battery is recharged
- When the 12-volt battery is reinstalled after removal or replacement
- When the related fuse is reinstalled after removal or replacement

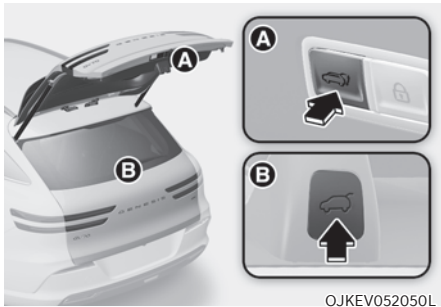

1. With the READY indicator on or off, put the gear in P (Park).
2. Press the power tailgate open/close inner button (A) and outer button (B) simultaneously until a chime sounds.
3. Slowly close the tailgate manually.
4. Press the power tailgate open/close outer button. The power tailgate will open with a chime sound.

Wait until the tailgate fully opens to complete resetting. If the tailgate stops before it is fully open, resetting cannot be completed.

### **i** Information

**If the power tailgate does not operate properly after the above procedure, we recommend that you have the system inspected by an authorized retailer of Genesis Branded products.**

### Emergency tailgate safety release

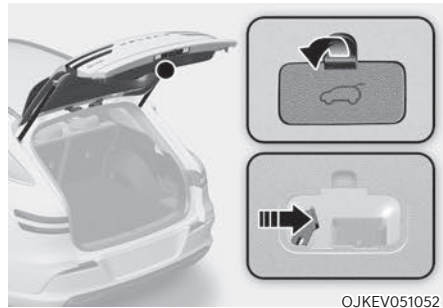

To unlock and open the tailgate manually from inside the luggage compartment, perform the following procedure:

1. Remove the cover at the bottom of the tailgate.
2. Slide the latch in the direction of the arrow to unlock the tailgate.
3. Push the tailgate to open.

**WARNING**

- For emergencies, be fully aware of the location of the emergency tailgate safety release latch in the vehicle and how to open the tailgate if you are accidentally locked in the luggage compartment.
- No one, including animals, should be allowed to occupy the luggage compartment of the vehicle at any time. The luggage compartment is a very dangerous location in the event of an accident.
- Use the release latch for emergencies only. Use extreme caution, especially while the vehicle is in motion.

## Smart tailgate

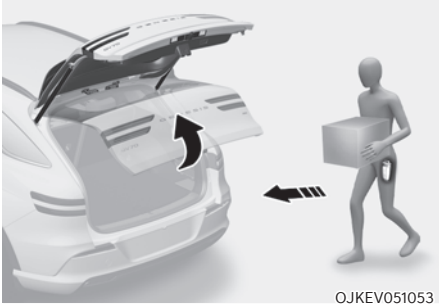

On a vehicle equipped with a smart key, the tailgate can be opened with hands-free activation using the smart tailgate system.

### Using smart tailgate

The hands-free smart tailgate system can be opened automatically when the following conditions are met:

- The smart tailgate option is enabled in the Settings menu in the infotainment system screen.
- The smart tailgate is activated and ready 15 seconds after all the doors are closed and locked.
- The smart tailgate will open when the smart key is detected in the area behind the vehicle for 3 seconds.

## **i** Information

The smart tailgate will **NOT** operate when:

- A door is not locked or closed.
- The smart key is detected within 15 seconds from when the doors were closed and locked.
- The smart key is detected within 15 seconds after the doors are closed and locked, and within 1.5 m (60 in.) from the front door handles. (for vehicles equipped with Welcome Light).
- The smart key is in the vehicle.

### 1. Settings

To use smart tailgate, it must be enabled from the Settings menu in the infotainment system screen. Select:

- Setup → Vehicle Settings → Door/Tailgate → Smart Tailgate

For detailed information, scan the QR code in a separately supplied simple manual.

### 2. Detect and Alert

The smart tailgate detecting area extends approximately 50-100 cm (20-40 in.) behind the vehicle. If you are positioned in the detecting area and are carrying the smart key, the hazard warning lights will blink and the chime will sound to alert you that the smart tailgate will open.

### **i** Information

**Do not approach the detecting area if you do not want the tailgate to open. If you have unintentionally entered the detecting area and the hazard warning lights and chime starts to operate, move away from the area behind the vehicle with the smart key. The tailgate will remain closed.**

#### 3. Automatic opening

After the hazard warning lights blink and the chime sounds 6 times, the smart tailgate will open.

### **Deactivating smart tailgate**

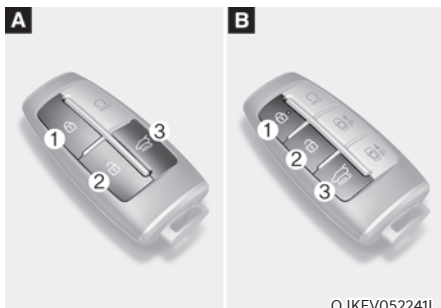

1. Door lock
2. Door unlock
3. Tailgate open/close

If you press any button on the smart key during the Detect and Alert stage, the smart tailgate will be deactivated.

Make sure to be aware of how to deactivate the smart tailgate for emergency situations.

- If you press the door unlock button (2), the smart tailgate will be deactivated temporarily. But, if you do not open any door for 30 seconds, the smart tailgate will be activated again.
- If you press the tailgate open button (3) for more than 1 second, the tailgate opens.
- The smart tailgate will still be activated if you press the door lock button (1) or tailgate open/close button (3) on the smart key as long as the smart tailgate is not already in the Detect and Alert stage.
- In case you have deactivated the smart tailgate by pressing the smart key button and opened a door, the smart tailgate can be activated again by closing and locking all doors.

### Detecting area



- The smart tailgate detecting area extends approximately 50-100 cm (20-40 in.) behind the vehicle. If you are positioned in the detecting area and are carrying the smart key, the hazard warning lights will blink and the chime will sound for about 3 seconds to alert you that the tailgate will open.
- The alert stops once the smart key is moved outside of the detecting area within the 3 second period.

### **i** Information

- Smart tailgate may not operate properly if any of the following occur:
  - The smart key is close to a radio transmitter such as a radio station or an airport which can interfere with normal operation of the transmitter.
  - The smart key is near a mobile two way radio system or a mobile phone.
  - Another vehicle's smart key is being operated close to your vehicle.
- Smart tailgate detecting area may change when:
  - The vehicle is parked on an incline or slope.
  - One side of the vehicle is raised or lowered relative to the opposite side.



## Charging door

### Opening the charging door

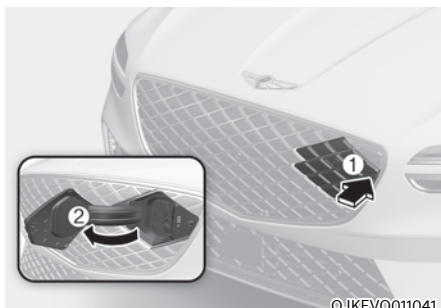

1. Depress the brake pedal and apply the parking brake.
2. Turn OFF all switches, shift to P (Park), and turn OFF the vehicle.
3. Push the charging door where the tringle symbol (1) is located to open. The charging door opens only when the vehicle is unlocked.
4. Open the inlet cover (2).

### **i** Information

**If you cannot open the charging door due to freezing weather, tap lightly or remove any ice near the charging door. Do not try to forcibly open the charging door.**

### Closing the charging door

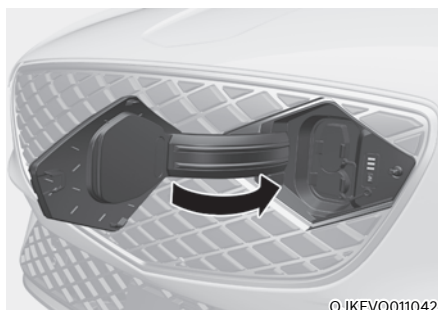

1. After recharging, install the charging inlet cover.
2. Close the charging door until it is latched securely.

For more details, refer to the Electric Vehicle Guide provided in the front of the owner's manual.

## HEAD-UP DISPLAY (HUD) (IF EQUIPPED)

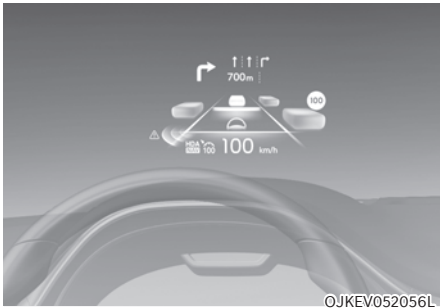

OJKEV052056L

The Head-Up Display is an optional feature that allows the driver to view information projected onto a transparent screen while still keeping your eyes safely on the road ahead while driving.

### Head-up display settings

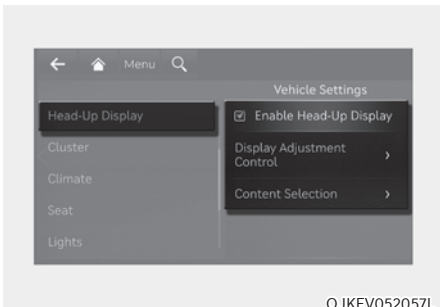

OJKEV052057L

- Head-up display can be enabled from the Settings menu in the infotainment system screen. Select:
  - Setup → Vehicle Settings → Head-Up Display → Enable Head-Up Display
- After turning on the head-up display, you can change the settings of 'Display Control' and 'Content Selection' of the Head-Up Display.  
For detailed information, scan the QR code in a separately supplied simple manual.

### Head-up display information

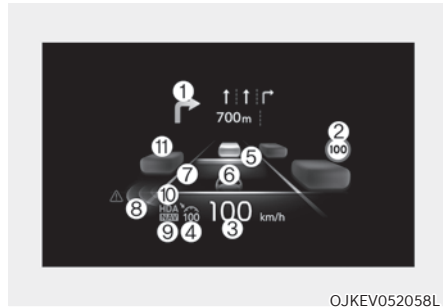

OJKEV052058L

- (1) Turn by Turn (TBT) navigation information
- (2) Traffic signs or speed limit
- (3) Speedometer information
- (4) SCC set speed information
- (5) SCC vehicle distance information
- (6) Lane Following Assist information
- (7) Lane Safety information
- (8) Blind-Spot Safety information
- (9) Highway Auto Speed Change information
- (10) Highway Driving Assist information
- (11) Surrounding vehicles

## Precautions while using the head-up display

- It may sometimes be difficult to read information on the Head-Up Display in the following situations.
  - The driver is improperly positioned in the driver's seat
  - The driver wears polarizing-filter sunglasses
  - An object is located above the head-up display cover
  - The vehicle is driven on a wet road
  - Any improper lighting accessory is installed inside the vehicle, or there is incoming light from outside of the vehicle
  - The driver wears glasses
  - The driver wears contact lenses

When it is difficult to read the Head-Up Display information, adjust the image height or brightness level from the Settings menu in the infotainment system screen.

- For your safety, make sure to stop the vehicle before adjusting the settings.
- Do not tint the front windshield glass or add other types of metallic coating. Otherwise, the Head-Up Display image may be invisible.
- Do not place any accessories on the crash pad or attach any objects on the windshield glass.
- When replacing the front windshield glass, replace it with a windshield glass designed for Head-Up Display operation. Otherwise, duplicated images may be displayed on the windshield glass.



### WARNING

**The warning information of Blind-Spot Safety on the Head-Up Display are supplemental. Do not solely depend on them to change lanes. Always take a look around before changing lanes.**



### Information

**Head-up Display includes GPL, LGPL, MPL and other open source license softwares. All license notices including related source code are provided at <http://www.mobis.co.kr/opensource/list.do>.**

**If the driver requests on-board software open source code via [MOBIS\\_OSSrequest@mobis.co.kr](mailto:MOBIS_OSSrequest@mobis.co.kr) within 3 years after buying this product, a CD-ROM or other storage device will be sent with the minimum cost covering storage device cost and delivery cost.**

## EXTERIOR LIGHTS

### Lighting control

To operate the lights, turn the knob at the end of the control lever to one of the following positions:

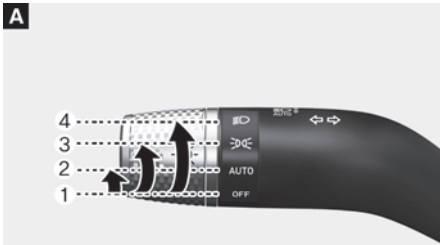

OJKEV052242L

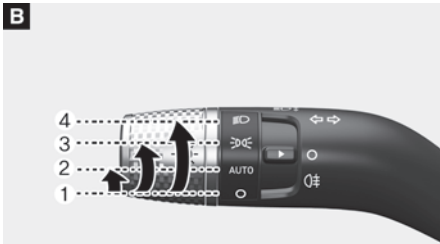

OJKEV052243L

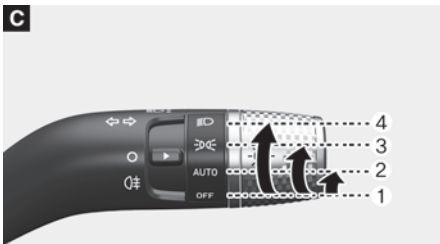

OJKEV052244L

1. OFF
2. AUTO headlamp
3. Position lamp
4. Headlamp

### Daytime Running Light (DRL)

The Daytime Running Lights (DRL) can make it easier for others to see the front of your vehicle during the day, especially after dawn and before sunset.

The DRL system will turn the dedicated lamp OFF when :

- The headlamps are ON.
- The parking brake is applied.
- The vehicle is turned off.

### AUTO headlamp

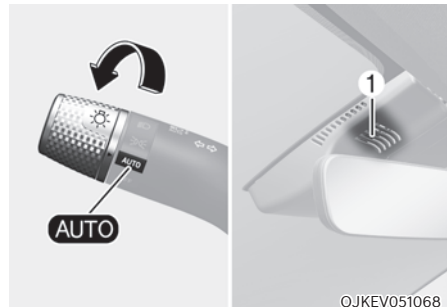

OJKEV051068

The position lamp and headlamp will be turned ON or OFF automatically depending on the amount of daylight as measured by the ambient light sensor (1) at the upper end of the windshield glass.

Even with the AUTO headlamp feature in operation, it is recommended to manually turn ON the headlamps when driving at night or in a fog, driving in the rain, or when you enter dark areas, such as tunnels and parking facilities.

**NOTICE**

- Do not cover or spill anything on the sensor (1) located at the upper end of the windshield glass.
- Do not clean the sensor using a window cleaner, the cleanser may leave a light film which could interfere with sensor operation.
- If your vehicle window is tinted or other types of metallic coating are on the front windshield, the AUTO headlamp system may not work properly.

**Position lamp** (⇒) (⇐)

The position lamp, license plate lamp and instrument panel lamp are turned ON.

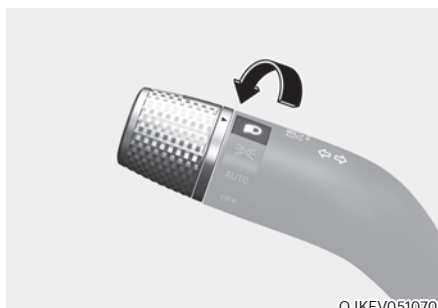
**Headlamp** (⇒) (⇐)

The headlamp, position lamp, license plate lamp and instrument panel lamp are turned ON.

**i Information**

The Start/Stop button must be in the ON position to turn on the headlamp.

### High beam operation

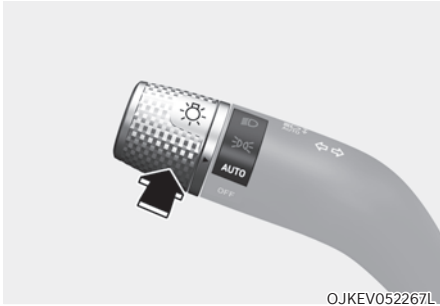

To turn on the high beam headlamp, push the lever away from you. The lever will return to its original position.

The high beam indicator will light when the headlamp high beams are switched on.

To turn off the high beam headlamp, pull the lever towards you. The low beams will turn on.

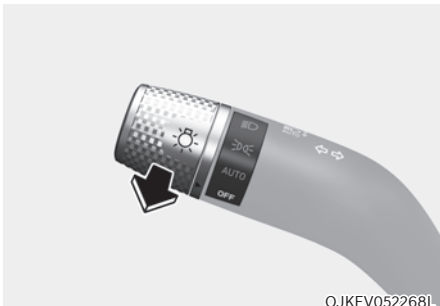

To flash the high beam headlamp, pull the lever towards you, then release the lever. The high beams will remain ON as long as you hold the lever towards you.

### Turn signals and lane change signals

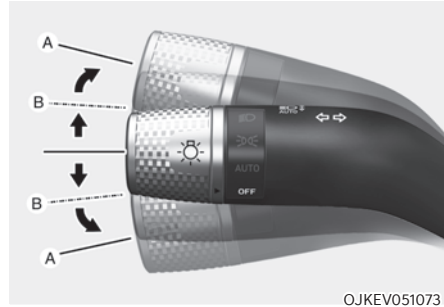

To signal a turn, push down on the lever for a left turn or up for a right turn in position (A).

If an indicator stays on and does not flash or if it flashes abnormally, one of the turn signal bulbs may be burned out and will require replacement.

#### One touch turn signal

To use One Touch Turn Signal push the turn signal lever up or down to position (B) and then release it.

The lane change signals will blink 3, 5 or 7 times.

You can enable the One Touch Turn Signal function or choose the number of blinking by selecting 'Setup → Vehicle Settings → Lights → One Touch Turn Signal (or One-touch indicator) → 3 flashes/5 flashes/7 flashes/Off' in the infotainment system screen.

For detailed information, scan the QR code in a separately supplied simple manual.

## Rear fog lamp



To turn on the rear fog lamp:  
Position the headlamp switch in the headlamp position, and then turn the headlamp switch (1) to the rear fog lamp position.

To turn the rear fog lamps off, do one of the following:

- Turn off the headlamp switch.
- Turn the headlamp switch (1) to the rear fog lamp position again.

## Battery saver function

The purpose of this feature is to prevent the battery from being discharged. The system automatically turns off the position lamp when the driver turns the vehicle off and opens the driver-side door.

With this feature, the position lamps will turn off automatically if the driver parks on the side of road at night.

However, the position lamps stay ON even when the driver-side door is opened if the headlamp switch is turned to the position lamp or AUTO (if equipped) position after the vehicle is turned off (READY indicator off).

If necessary, to keep the lamps on turn the position lamps OFF and ON again using the headlamp switch on the steering column after the vehicle is turned off.

## Headlamp delay function

If the Start/Stop button is in the ACC position or the OFF position with the headlamps ON, the headlamps (and/or position lamps) remain on for about 5 minutes. However, if the driver's door is opened and closed, the headlamps are turned off after 15 seconds. Also, with the vehicle off if the driver's door is opened and closed, the headlamps (and/or position lamps) are turned off after 15 seconds.

The headlamps (and/or position lamps) can be turned off by pressing the lock button on the smart key twice or turning the headlamp switch to the OFF or AUTO position.

You can enable the headlamp delay function by selecting 'Setup → Vehicle Settings → Lights → Headlight Delay (or Headlight time-out)' in the infotainment system screen.

For detailed information, scan the QR code in a separately supplied simple manual.

### NOTICE

**If the driver exits the vehicle through another door besides the driver door, the battery saver function does not operate and the headlamp delay function does not turn OFF automatically.**

**This may cause the battery to discharge. To avoid battery discharge, turn OFF the headlamps manually from the headlamp switch before exiting the vehicle.**

### Headlight leveling device

Headlight leveling device automatically adjusts the headlamp beam level according to the number of passengers and loading weight in the luggage area. It also adjusts to the appropriate headlamp beam level for various situations.



#### **WARNING**

**If the function does not work properly, we recommend that the system be inspected by an authorized retailer of Genesis Branded products. Do not attempt to inspect or replace the wiring yourself.**

### Headlamp moisture removal function

When moisture fogs up inside of the headlamp with the headlamp on for a certain period of time, the fan circulates air inside the headlamp to remove moisture. If moisture is not removed, we recommend that the vehicle be inspected by an authorized retailer of Genesis Branded products.

### Reverse guide lamp

When the gear is in R (Reverse), the reverse lamp turns on and the reverse guide lamp at the back of the vehicle lights the floor.

The lamp informs nearby drivers that your vehicle is backing up.



## INTERIOR LIGHTS



### WARNING

Do not use the interior lights when driving in the dark. The interior lights may obscure your view and cause an accident.

### NOTICE

Do not use the interior lights for extended periods when the vehicle is turned off or the battery will discharge.

### Interior lamp AUTO cut

The interior lamps will automatically go off approximately 20 minutes after the vehicle is turned off and the doors are closed. If a door is opened, the lamp will go off 25 minutes after the vehicle is turned off. If the doors are locked by the smart key and the vehicle enters the armed stage of the theft alarm system, the lamps will go off five seconds later.

### Front lamps

Front map lamp ( ):



Touch either icons to turn the map lamp on or off. This light produces a spot beam for convenient use as a map lamp at night or as a personal lamp for the driver and the front passenger.

### Door lamp ( ):

The front or rear room lamps come on when the front or rear doors are opened. When doors are unlocked by the smart key, the front and rear lamps come on for approximately 30 seconds as long as any door is not opened. The front and rear room lamps go out gradually after approximately 30 seconds when the door is closed. However, if the Start/Stop button is in the ON position or all doors are locked, the front and rear lamps will turn off. If a door is opened with the Start/Stop button in the ACC position or the OFF position, the front and rear lamps will stay on for about 5 minutes.



### Room lamp ( ):

Press the button to turn ON the room lamp for the front/rear seats.

### Rear lamps



[A]: Room lamp (without sunroof)

-  :  
Touch the icon to turn either lamp on or off.
-  :  
Touch the icon to turn the mood lamp on or off.



[B]: Personal lamp (with sunroof)

-  :  
Press the button to turn the lamp on or off.

### Vanity mirror lamp



Opening the lid of the vanity mirror will automatically turn on the mirror lamp.

### Glove box lamp

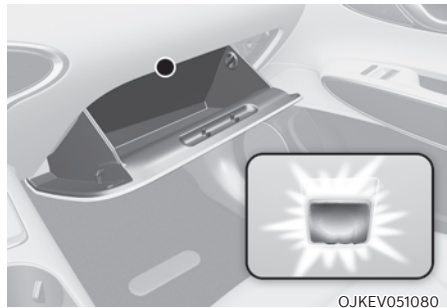

The glove box lamp turns on when the glove box is opened.

### Door handle lamp/Mood lamp/ Door courtesy lamp (if equipped)

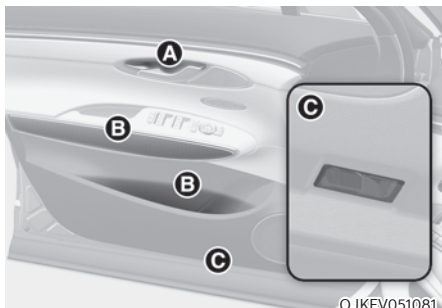

OJKEV051081

- Door handle lamp (A):  
The lamp turns on when the position lamps are on.
- Mood lamp (B):  
The lamp turns on when 'Setup → Vehicle Settings → Lights → Ambient Light' is selected from the infotainment system screen.
- Door courtesy lamp (C):  
The lamp turns on when a door is open and turns off when the door is closed.

### Luggage compartment lamp



OJKEV051082

The lamp turns on when the tailgate is opened.

### Puddle lamp *Welcome light*



OJKEV051083

When all doors (and tailgate) are closed and locked, the puddle lamp will turn on for 15 seconds if the door is unlocked by the smart key or when you put your hand in the outside door handle with the smart key in possession.

For more details, refer to “Welcome System” in this chapter.

### *Escort light*

When the Start/Stop button is in the OFF position and the driver's door is opened, the puddle lamp will turn on for 30 seconds. If the driver's door is closed within the 30 second period, the puddle lamp will turn off after 15 seconds. If the driver's door is closed and locked, the puddle lamp will turn off immediately.

The Puddle Lamp Escort Light will turn on only the first time the driver's door is opened after the vehicle is turned off (READY indicator off).

## Welcome system



Welcome system helps keep the driver visible by turning on vehicle lights when the driver approaches the vehicle.

### ***Puddle lamp and door handle lamp***

When all the doors (and tailgate) are closed and locked, the puddle lamp and door handle lamp will turn on for approximately 15 seconds if any of the below is performed.

- When the door unlock button is pressed on the smart key.
- When you put your hand in the outside door handle with the smart key in possession.
- If 'Setup → Vehicle Settings → Lights → Welcome Mirror/Light → Enable on Driver Approach' is selected from the Settings menu in the infotainment system screen, the lamps will turn on when the vehicle is approached with the smart key in possession.

For detailed information, scan the QR code in a separately supplied simple manual.

### ***Headlamp and position lamp***

When the light switch is ON, and all the doors (and tailgate) are closed and locked, the headlamp and position lamp will turn on for approximately 15 seconds if the door unlock button is pressed on the smart key. Note that if the light switch is in the AUTO position, the headlamp and position light will turn on only when it is dark outside.

Select 'Setup → Lights → Headlight Delay' from the Settings menu to turn on this function.

### ***Interior lamp***

When the interior lamp switch is in the  position and all doors (and tailgate) are closed and locked, the room lamp will come on for 30 seconds if any of the below is performed.

- When the door unlock button is pressed on the smart key.
- When you put your hand in the outside door handle while carrying the smart key.

At this time, if you press the door lock or unlock button on the smart key the lamps will turn off immediately.

## INTELLIGENT FRONT-LIGHTING SYSTEM (IFS) (IF EQUIPPED)

Intelligent Front-Lighting System secures a clear view for the driver with the high beam on while driving at night.

### Intelligent Front-Lighting System settings

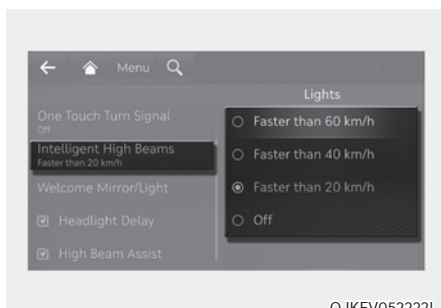

OJKEV052222L

With the Start/Stop button in the ON position, select 'Lights → Intelligent High Beams' from the Settings menu to turn on Intelligent Front-Lighting System and deselect to turn off the system.



### WARNING

**For your safety, change the Settings after parking the vehicle at a safe location.**

### Intelligent Front-Lighting System operation

#### Operating conditions



OJKEV051075

1. Place the headlamp switch in the AUTO position.
2. Push the headlamp lever toward the instrument cluster. The Intelligent Front-Lighting System (IFS) indicator light will illuminate on the cluster and the system will be enabled.
3. Intelligent Front-Lighting System will operate according to the set speed in the infotainment system. The initial system is set to work when vehicle speed is above 40 km/h (25 mph).

### Operating Intelligent Front-Lighting System

- The high beam LED partially turns off if an oncoming vehicle or a vehicle ahead is detected by the front view camera.
- If Intelligent Front-Lighting System detects an oncoming vehicle or a vehicle ahead while driving at high speed (approximately above 100 km/h (60 mph), the driver's side headlamp will turn off and only the passenger's side headlamp will be controlled by the system.

### Information

**Intelligent Front-Lighting System operates when vehicle speed is above the set speed from the settings menu and when the outside ambient light condition is dark. Therefore, Intelligent Front-Lighting System may not work in areas with bright streetlights.**

### Intelligent Front-Lighting System malfunction and limitations *Intelligent Front-Lighting System malfunction*

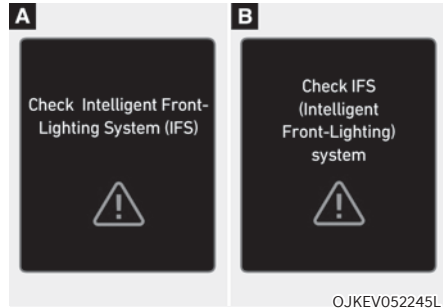

When Intelligent Front-Lighting System is not working properly, the 'Check Intelligent Front-Lighting System (IFS)' (or 'Check IFS (Intelligent Front-Lighting) system') warning message will come on for a few second on the cluster. After the message disappears, AFS and  warning lights will illuminate on the cluster. We recommend that the system be inspected by an authorized retailer of Genesis Branded products.

### **Intelligent Front-Lighting System disabled**

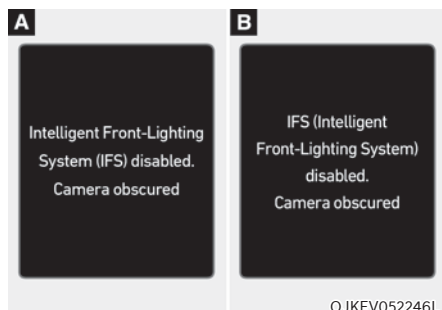

OJKEV052246L

When the front view camera is covered with dirt, snow, or debris, Intelligent Front-Lighting System may temporarily not work properly. If this occurs, the ‘Intelligent Front-Lighting System (IFS) disabled. Camera obscured’ (or ‘IFS (Intelligent Front-Lighting System) disabled. Camera obscured’) warning message will appear on the cluster.

The system will operate normally when such dirt, snow or debris is removed.

Intelligent Front-Lighting System may not properly operate in an area (for example, open terrain) where any objects or vehicles are not detected after turning on the vehicle.

Also, even though a warning message does not appear on the cluster, the system may not properly operate.

### **Limitations of Intelligent Front-Lighting System**

Intelligent Front-Lighting System may not work properly in the following situations:

- Light from a vehicle is not detected because of lamp damage, or because it is hidden from sight, etc.
- Headlamp of a vehicle is covered with dust, snow or water.
- A vehicle’s headlamps are off but the fog lamps are on and etc.
- There is a lamp that has a similar shape as a vehicle’s lamp.
- Headlamps have been damaged or not repaired properly.
- Headlamps are not aimed properly.
- Driving on a narrow curved road, rough road, uphill or downhill.
- Vehicle in front is partially visible on a crossroad or curved road.
- There is a traffic light, reflecting sign, flashing sign or mirror ahead.
- There is a temporary reflector or flash ahead (construction area).
- The road conditions are bad such as being wet, iced or covered with snow.
- A vehicle suddenly appears from a curve.
- The vehicle is tilted from a flat tire or is being towed.
- There are many street lights or the ambient light is bright.
- Light from a vehicle is not detected because of exhaust fume, smoke, fog, snow, etc.
- The front windshield is covered with foreign substance.



**CAUTION**

- Never install any accessories or stickers on the front windshield, or tint the front windshield.
- If the front view camera have been replaced or repaired, the system may need to be calibrated. We recommend that you have your vehicle inspected by an authorized retailer of Genesis Branded products.
- Pay extreme caution to keep the front view camera dry, and do not remove or damage related parts of the Intelligent Front-Lighting System.
- Never place any reflective objects (for example, white paper, mirror) over the dashboard. Any light reflection may prevent the system from functioning properly.



**WARNING**

- At times, Intelligent Front-Lighting System may not work properly. The system is for your convenience only. It is the responsibility of the driver for safe driving practices and always check the road conditions for your safety.
- When the system does not operate normally, switch the headlamp position manually between high beam and low beam.



## HIGH BEAM ASSIST (HBA) (IF EQUIPPED)

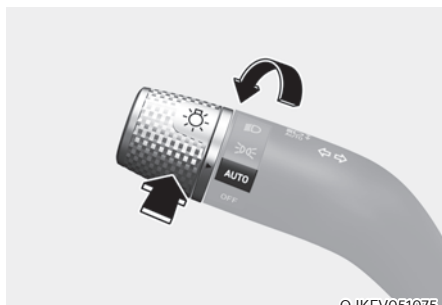

OJKEV051075

High Beam Assist will automatically adjust the headlamp range (switches between high beam and low beam) depending on the brightness of detected vehicles and certain road conditions.

### Detecting sensor

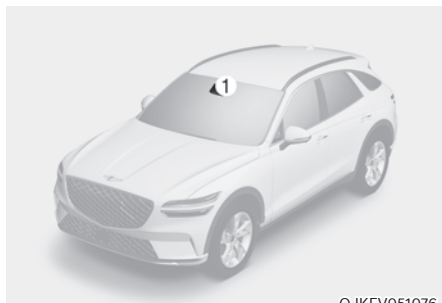

OJKEV051076

[1]: front view camera

The front view camera is used as a detecting sensor to detect ambient light and brightness while driving.

Refer to the picture above for the detailed location of the detecting sensor.

### NOTICE

- Always keep the front view camera in good condition to maintain optimal performance of High Beam Assist.
- For more details on the precautions of the front view camera, refer to “Forward Collision-Avoidance Assist (FCA)” section in chapter 7.

### High Beam Assist settings

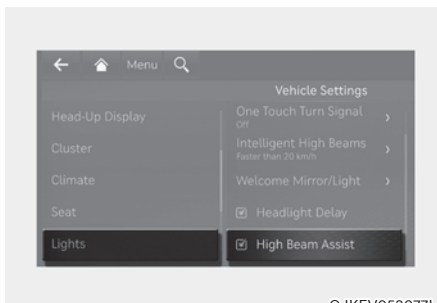

OJKEV052077L

With the Start/Stop button in the ON position, select ‘Lights → High Beam Assist (or HBA (High Beam Assist))’ from the Settings menu to turn on High Beam Assist and deselect to turn off the function.



### WARNING

**For your safety, change the Settings after parking the vehicle at a safe location.**

## High Beam Assist operation

### Display and control

- After selecting 'High Beam Assist' in the Settings menu, High Beam Assist will operate by following the procedure below.
  - Place the headlamp switch in the AUTO position and push the headlamp lever towards the instrument cluster. The High Beam Assist (AUTO) indicator light will illuminate on the cluster and High Beam Assist will be enabled.
  - When High Beam Assist is enabled, high beam will turn on when vehicle speed is above 40 km/h (25 mph). When vehicle speed is below 25 km/h (15 mph), high beam will not turn on.
  - The High Beam (H) indicator light will illuminate on the cluster when high beam is on.
- When High Beam Assist is operating, if the headlamp lever or switch is used, High Beam Assist operates as follow:
  - If the headlamp lever is pulled towards you when the high beam is off, the high beam will turn on without High Beam Assist canceled. When you let go of the headlamp lever, the lever will move to the middle and the high beam will turn off.
  - If the headlamp lever is pulled towards you when the high beam is on by High Beam Assist, low beam will be on and the function will turn off.
  - If the headlamp switch is placed from AUTO to another position (headlamp/position/off), High Beam Assist will turn off and the corresponding lamp will turn on.
- When High Beam Assist is operating, high beam switches to low beam if any of the following conditions occur:
  - When the headlamp of an oncoming vehicle is detected.
  - When the tail lamp of a vehicle in front is detected.
  - When the headlamp or tail lamp of a motorcycle or a bicycle is detected.
  - When the surrounding ambient light is bright enough that high beams are not required.
  - When streetlights or other lights are detected.





### Information

**The images and colors in the cluster may differ depending on the cluster type or theme selected from the cluster.**

## High Beam Assist malfunction and limitations

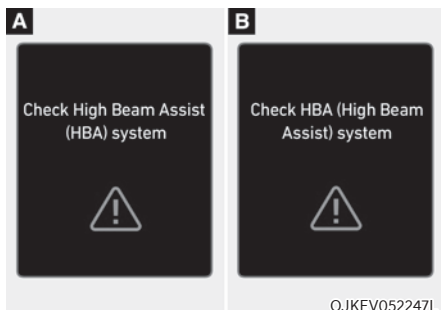
### High Beam Assist malfunction



When High Beam Assist is not working properly, the 'Check High Beam Assist (HBA) system' (or 'Check HBA (High Beam Assist) system') warning message will appear and  warning light will illuminate on the cluster. We recommend that the function be inspected by an authorized retailer of Genesis Branded products.

### Limitations of High Beam Assist

High Beam Assist may not work properly in the following situations:

- Light from a oncoming or front vehicle is not detected because of lamp damage, or because it is hidden from sight, etc.
- Headlamp of a oncoming or front vehicle is covered with dust, snow or water.
- A front vehicle's headlamps are off but the fog lamps are on, etc.
- There is a lamp that has a similar shape as a vehicle's lamp.
- Headlamps have been damaged or not repaired properly.

- Headlamps are not aimed properly.
- Driving on a narrow curved road, rough road, uphill or downhill.
- Vehicle in front is partially visible on a crossroad or curved road.
- There is a traffic light, reflecting sign, flashing sign or mirror ahead.
- There is a temporary reflector or flash ahead (construction area).
- The road conditions are bad such as being wet, iced or covered with snow.
- A vehicle suddenly appears from a curve.
- The vehicle is tilted from a flat tire or is being towed.
- Light from a oncoming or front vehicle is not detected due to obstacles in the air such as exhaust fume, smoke, fog, snow, or water spay or blizzard on the road, or fogging in the lamp, etc.

### Information

For more details on the limitations of the Front View Camera, refer to "Forward Collision-Avoidance Assist (FCA)" section in chapter 7.

### WARNING

- **At times, High Beam Assist may not work properly. High Beam Assist is for your convenience only. It is the responsibility of the driver for safe driving practices and always check the road conditions for your safety.**
- **When High Beam Assist does not operate normally, change the headlamp position manually between high beam and low beam.**

## WIPERS AND WASHERS

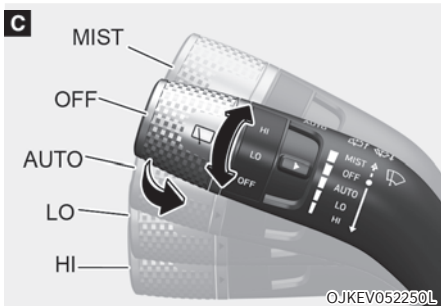
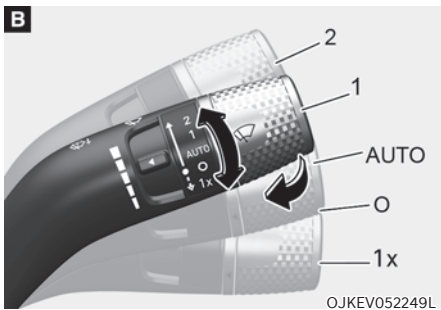
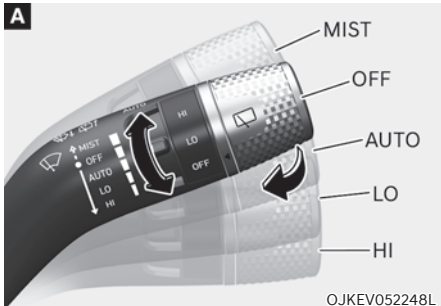

### Front windshield wipers

Operates as follows when the Start/Stop button is in the ON position.

**MIST (1x):** For a single wiping cycle, push the lever upward (or downward) and release. The wipers will operate continuously if the lever is held in this position.

**OFF (O):** Wiper is not in operation.

**AUTO:** The rain sensor located on the upper end of the windshield glass senses the amount of rainfall and controls the wiping cycle for the proper interval. The more it rains, the faster the wiper operates. When the rain stops, the wiper stops. To vary the speed setting, turn the speed control switch.

**LO (1):** The wiper runs at a lower speed.

**HI (2):** The wiper runs at a higher speed.

### Information

**If there is heavy accumulation of snow or ice on the windshield, defrost the windshield for about 10 minutes, or until the snow and/or ice is removed before using the windshield wipers to ensure proper operation.**

**If you do not remove the snow and/or ice before using the wiper and washer, it may damage the wiper and washer system.**

### AUTO (Automatic) control



OJKEV051085

The rain sensor located on the upper end of the windshield glass senses the amount of rainfall and controls the wiping cycle for the proper interval.

The wiper operation time will be automatically controlled depends on rainfall.

When the rain stops, the wiper stops.

To vary the sensitivity setting, turn the sensitivity control knob.

If the wiper switch is set in AUTO mode when the Start/Stop button is in the ON position, the wiper will operate once to perform a self-check of the system. Set the wiper to the OFF (O) position when the wiper is not in use.



### WARNING

To avoid personal injury from the windshield wipers, when the READY indicator is on and the windshield wiper switch is placed in the AUTO mode:

- Do not touch the upper end of the windshield glass facing the rain sensor.
- Do not wipe the upper end of the windshield glass with a damp or wet cloth.
- Do not put pressure on the windshield glass.

### NOTICE

- When washing the vehicle, set the wiper switch in the OFF (O) position to stop the auto wiper operation. The wiper may operate and be damaged if the switch is set in the AUTO mode while washing the vehicle.
- Do not remove the sensor cover located on the upper end of the passenger side windshield glass. Damage to system components could occur and may not be covered by your vehicle warranty.
- Because of using a photo sensor, temporary malfunction could occur according to sudden ambient light change made by stone and dust while driving.

## Front windshield washers

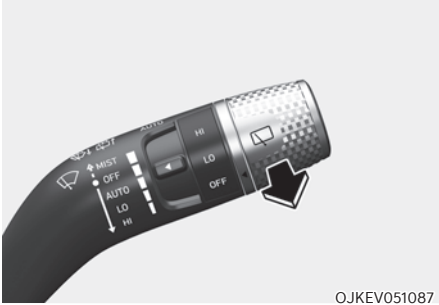

In the OFF (O) position, pull the lever gently toward you to spray washer fluid on the windshield and to run the wipers 1-3 cycles. The spray and wiper operation will continue until you release the lever. If the washer does not work, you may need to add washer fluid to the washer fluid reservoir.

### ***Recirculating air when washer fluid is used***

When washer fluid is used, in order to reduce any objectionable scent of the washer fluid from entering the cabin, recirculation mode and air conditioning are automatically activated depending on the outside temperature. If you select fresh mode while the function is operating, the function will resume after a certain amount of time. It may not work in some conditions such as cold weather or the READY indicator OFF.

For more details, refer to “Climate Control Additional Features” section in this chapter.

### **WARNING**

When the outside temperature is below freezing, **ALWAYS** warm the windshield using the defroster to help prevent the washer fluid from freezing on the windshield and obscuring your vision which could result in an accident and serious injury or death.

### **NOTICE**

- To prevent possible damage to the washer pump, do not operate the washer when the fluid reservoir is empty.
- To prevent possible damage to the wipers or windshield, do not operate the wipers when the windshield is dry.
- To prevent damage to the wiper arms and other components, do not attempt to move the wipers manually.
- To prevent possible damage to the wipers and washer system, use anti-freezing washer fluids in the winter season or cold weather.

## Rear window wiper and washer

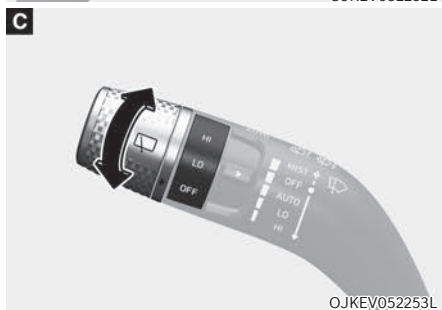
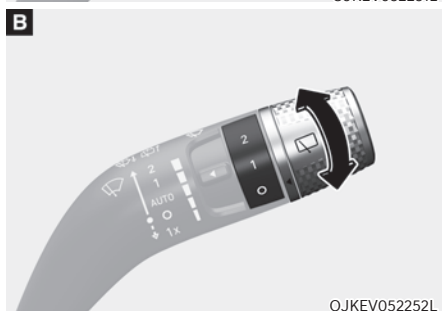
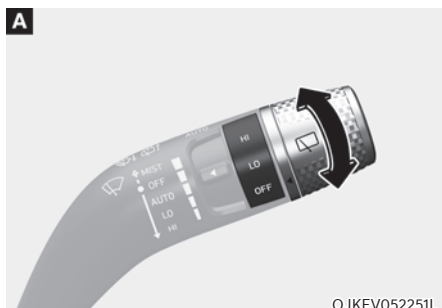

The rear window wiper and washer switch is located at the end of the wiper and washer switch lever. Turn the switch to the desired position to operate the rear wiper and washer.

HI (2): High wiper speed

LO (1): Low wiper speed

OFF (O): Off

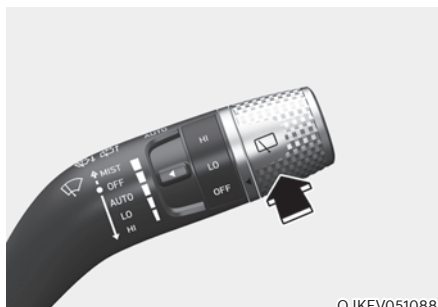

Push the lever away from you to spray rear washer fluid and to run the rear wipers 1~3 cycles. The spray and wiper operation will continue until you release the lever.

### Auto rear wiper

The rear wiper will operate while the vehicle is in reverse with the front wiper ON by selecting the function from the Settings menu in the infotainment system screen. Select:

- Setup → Vehicle Settings → Convenience → Auto Rear Wiper (in R)

For detailed information, scan the QR code in a separately supplied simple manual.

## AUTOMATIC CLIMATE CONTROL SYSTEM

### Front seat

**A**



**B**



OJKEV052100L/OJKEV051101

#### **[A] Front seat control**

1. Driver's temperature control
2. Passenger's temperature control
3. Fan speed control
4. Driver's mode selection
5. Passenger's mode selection
6. AUTO (automatic control)
7. OFF (system off)
8. Front windshield defroster
9. Air intake control
10. SYNC

11. Rear window defroster
12. A/C (air conditioning)
13. Rear control
14. Driver's seat climate control
15. HEAT button

#### **[B] Rear seat control**

1. Temperature control
2. Mode selection
3. AUTO
4. OFF (system off)
5. Climate control information screen

### **i** Information

Use a clean soft microfiber cloth to gently wipe any finger prints off the touch screen.



**Rear seat (if equipped)**

OJKEV052102L

1. Fan speed control
2. Temperature control
3. OFF (system off)
4. AUTO (automatic control)
5. Mode selection

***i* Information**

Temperature and Mode selection (air flow direction) can be controlled from the rear seat. However, if 'Setup → Vehicle Settings → Climate → Climate Features → Lock the Rear Climate Control' is selected, the rear climate control can be operated only from the front seat. Deselect 'Lock the Rear Climate Control' before using it from the rear seats.

## Automatic temperature control mode

The Automatic Climate Control System is controlled by setting the desired temperature.

1. Select AUTO.

The mode selection, fan speed, air intake and air-conditioning will be controlled automatically by the temperature setting you select.

2. When the climate control system is being automatically controlled, fan speed can be selected (Low/Medium/High).

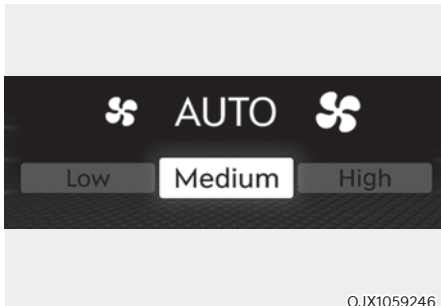

OJX1059246

- High: Use when quick heating or cooling is preferred with higher fan speed capability.
- Medium: Use when medium fan speed is preferred for cooling or heating with moderate fan speed capability.
- Low: Use when low fan speed is preferred for cooling or heating with lower fan speed capability.

3. Turn the temperature control knob to the desired temperature. If the temperature is set to the lowest setting (Lo), the air conditioning system will operate continuously. After the interior has cooled sufficiently, adjust the knob to a higher temperature set point whenever possible.

To turn the automatic operation off, select any function of the following:

- Mode selection (for Europe)
- Front windshield defroster (Press the button one more time to deselect the front windshield defroster function. The 'AUTO' sign will illuminate on the climate information screen once again.)
- Fan speed control
- A/C (air conditioning) (except Europe)

The selected function will be controlled manually while other functions operate automatically.

For your convenience and to improve the efficiency of the climate control, use the AUTO button and set the temperature to 22°C (72°F).

To change the temperature unit from °C to °F or °F to °C:

Select 'Setup → General Settings → Unit → Temperature Unit → °C/°F' from the Settings menu in the infotainment system screen.

## **i** Information



OJKEV051085



**Never place anything near the ambient light/solar sensor to ensure better control of the heating and cooling system.**

## **Manual temperature control mode**

The heating and cooling system can be controlled manually by selecting functions other than AUTO. In this case, the system works sequentially according to the order of the functions selected.

When selecting any other functions except AUTO while using automatic operation, the functions not selected will be controlled automatically.

1. Start the vehicle.
2. Set the mode to the desired position.  
To improve the effectiveness of heating and cooling, select the mode according to the following:

- Heating: 
- Cooling: 

3. Set the temperature control to the desired position.
4. Set the air intake control to Fresh or Recirculation mode.
5. Set the fan speed control to the desired speed.
6. If air conditioning is desired, turn the air conditioning system on.
7. Select AUTO to revert back to full automatic control of the system.

The climate control system settings will be maintained, even when the vehicle is turned off. However, the climate control system settings will be initialized when the battery has been discharged, or when the cables have been disconnected.

In this case, adjust the climate control system settings again.

### Mode selection

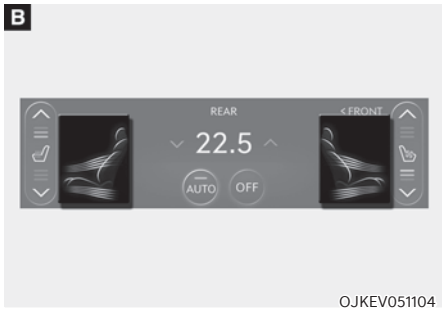

[A]: Front seat control, [B]: Rear seat control

#### Front seat mode selection

- Touch the air flow direction on the climate control information screen to select air flow direction.
- Touch SYNC and when the SYNC indicator light turns off, the air flow direction of the driver's seat, passenger seat, and rear seat can be controlled individually. However, passengers and rear seats cannot select .
- Touch REAR (1) to control the rear seat mode selection from the front seats.
- You may select 2~3 modes at the same time.

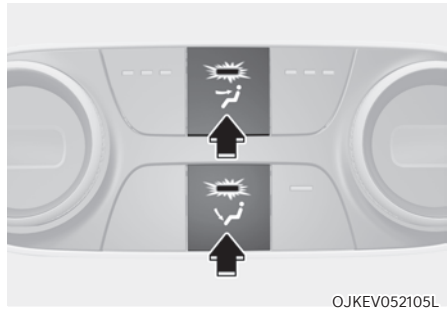

#### Rear seat mode selection

- Press the button to select the direction of the air flow to the desired position.
- You may select 2 modes at the same time.



OJKEV052125L

[A]: Left-hand drive

### Air flow direction

The mode selection Icon or button controls the direction of the air flow through the ventilation system.



OJKEV052126R

[B]: Right-hand drive

**Air flow direction**

The mode selection Icon or button controls the direction of the air flow through the ventilation system.

- Front seat



Most of the air flow is directed to the windshield.



Air flow is directed toward the upper body and face. Additionally, each outlet can be controlled to direct the air discharged from the outlet.



Most of the air flow is directed to the floor, with a small amount of the air being directed to the windshield and side window defrosters.

- Rear seat



Air flow is directed toward the upper body and face.



Most of the air flow is directed to the floor.

### Information

**Two to three air flow modes can be selected at the same time.**

### Front windshield defroster



#### Defrost-level (A, D)

Press the button, and the indicator light will illuminate and the windshield defroster indicator will appear on the climate control information screen.

Most of the air flow is directed to the windshield with a small amount of air directed to the side window defrosters.

When Defogging logic is enabled, Fresh mode is selected and air conditioning is selected according to outside temperature.

Press the button, the indicator light will turn off and the previous settings will be selected.

### Instrument panel vents

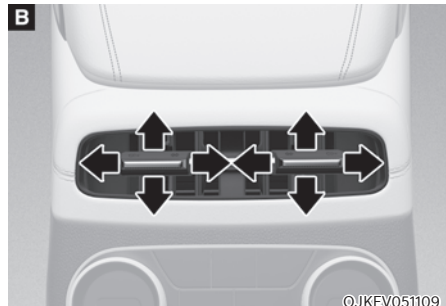
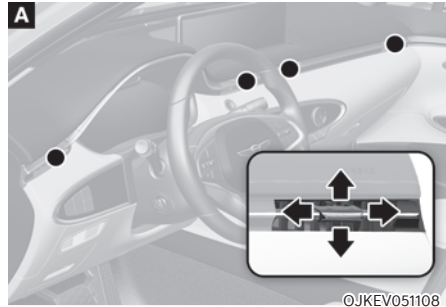

[A]: Front seat, [B]: Rear seat

The instrument panel vent air flow can be directed up/down or left/right using the vent adjustment lever.

The air flow can also be CLOSED using the vent adjustment lever.

Move the lever away horizontally from the seat to close until the levers click and lock. Slightly move the lever toward the sitting position to unlock and open.



## Temperature control



- [A]: Front seat (Front seat control),  
 [B]: Front seat (Rear seat control),  
 [C]: Rear seat

Turn the knob to the right to increase the temperature. Turn the knob to the left to decrease temperature.

Also, touch the  $\wedge$  or  $\vee$  icon to select the temperature for rear seats from the front seats.

The temperature can be increased or decreased by increments of  $0.5^{\circ}\text{C}$  ( $1^{\circ}\text{F}$ ) for each incremental location. When set to the lowest temperature setting, the air conditioning will operate continuously to quickly cool the interior of the vehicle initially. After interior temperature has been cooled down sufficiently, select AUTO and set the temperature to  $22^{\circ}\text{C}$  ( $72^{\circ}\text{F}$ ).

## SYNC

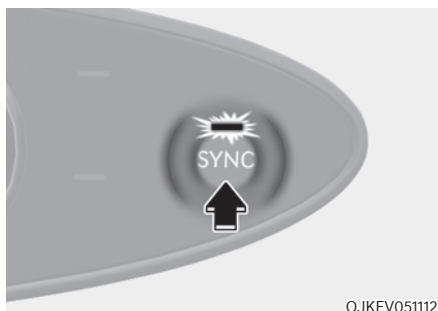

### Adjusting the temperature and air flow direction equally

Press SYNC (indicator light ON), the rear seat's temperature and air flow direction will be adjusted same as the driver's control. You can also turn the SYNC function on or off by touching the air flow direction of the driver's seat and the passenger seat at the same time on the front climate control information screen.

### Adjusting the temperature and air flow direction individually

Press SYNC (indicator light OFF), the front and rear seat's temperature and air flow direction will be adjusted individually.

### Air intake control

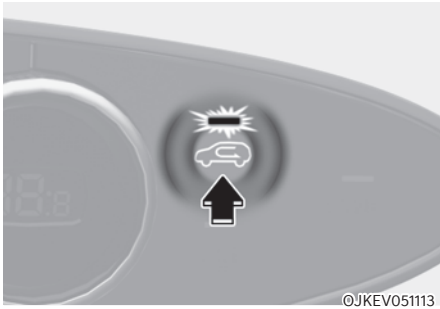

Air intake control is used to select either Fresh mode (outside air) or Recirculation mode (cabin air).

#### Recirculation mode



When Recirculation mode is selected, air from the passenger compartment will be recirculated through the system and heated or cooled according to the function selected.

#### Fresh mode



When Fresh mode is selected, air enters the vehicle from outside and is heated or cooled according to the function selected.

### Information

Operating the system primarily in Fresh mode is recommended. Use Recirculation mode temporarily only when needed. Prolonged operation of the heater in Recirculation mode and without the air conditioning ON can cause fogging of the windshield. In addition, prolonged use of the air conditioning ON in Recirculation mode may result in excessively dry, dehumidified air in the cabin and may promote formation of musty vent odor due to stagnant air.

### WARNING

- Continued use of the climate control system operation in Recirculation mode for a prolonged period of time may cause drowsiness to the occupants in the cabin. This may lead to loss of vehicle control which may lead to an accident.
- Continued use of the climate control system operation in Recirculation mode with the air conditioning OFF may allow humidity to increase inside the cabin. This may cause condensation to accumulate on the windshield and obscure visibility.
- Do not sleep in your vehicle or remain parked in your vehicle with the windows up and either the heater or the air conditioning ON for prolonged periods of time. Doing so may increase the levels of carbon dioxide in the cabin which may lead to serious injury or death.

## Fan speed control

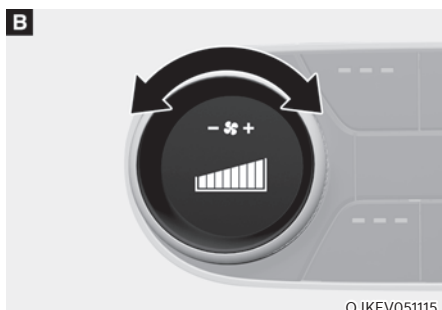

[A]: Front seat, [B]: Rear seat

The fan speed can be set to the desired speed by touching the or icon, or by turning the fan speed control knob.

More air is delivered with higher fan speeds.

Pressing the OFF icon or button turns off the fan.

The airflow in the front and rear seats is always operated in conjunction.

## Information

To help improve microphone voice input sound, fan speed may automatically slow down for a couple of minutes when you activate voice recognition or hands free.

## **NOTICE**

Operating the fan when the Start/Stop button is in the ON position could cause the battery to discharge. Operate the fan when the READY indicator is on.

## Air conditioning



Touch the A/C icon to manually turn the air conditioning on (indicator light ON) and off.

### Driver only



If you touch the DRIVER ONLY icon (DRIVER ONLY) and the indicator light illuminates in the infotainment climate control screen, cold air mostly blows in the driver's seat. However, some of the cold air may come out of other seating position ducts to keep indoor air pleasant.

If you use the DRIVER ONLY with no passenger in the front passenger seat, energy consumption will be reduced.

DRIVER ONLY will be turned off under the following conditions:

- (1) Defrost on
- (2) DRIVER ONLY icon re-touch
- (3) Passenger's mode selection
- (4) SYNC
- (5) Passenger's temperature control

### HEAT button



Touch CLIMATE icon in the climate control panel. The climate information screen will appear on the infotainment screen. Touch the HEAT icon in the infotainment screen to turn the heater on (indicator light will illuminate). Touch the button again to turn the heater off.

The air conditioner and heater uses energy from the high voltage battery. If you use the heater or air conditioner for too long, distance to empty can be reduced due to too much power consumption.

Turn off the heater and air conditioner if you do not need them.

### Information

**If the vehicle is turned off after the heating and cooling operation, a sound may occur temporarily as the air climate system mode is changed.**

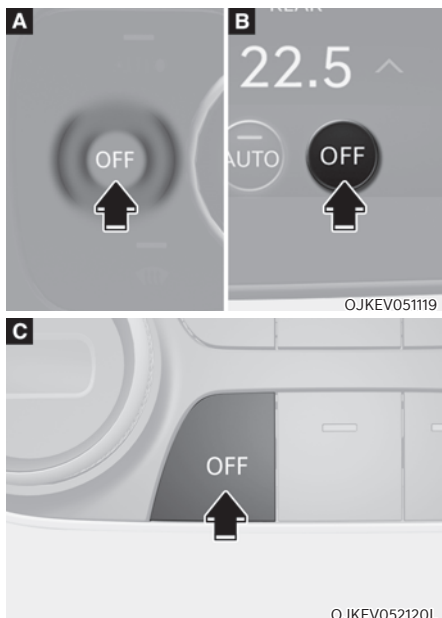
**OFF mode**

[A]: Front seat (Front seat control),  
 [B]: Front seat (Rear seat control),  
 [C]: Rear seat

Touch the OFF icon or press the OFF button to turn the climate control system off. You can still operate mode selection and air intake control as long as the Start/Stop button is in the ON position.

**System operation****Cooling / Ventilation**

1. Select the Face Level (👤) mode.
2. Set the air intake control to fresh or recirculation mode.
3. Set the temperature control to the desired position.
4. Set the fan speed control to the desired speed.

**Heating**

1. Select the Floor Level (👤) mode.
2. Set the air intake control to fresh or recirculation mode.
3. Set the temperature control to the desired position.
4. Set the fan speed control to the desired speed.
5. If desired, turn the air conditioning ON with the temperature control knob set to heat in order to dehumidify the air before it enters into the cabin.

If the windshield fogs up, select the Front Defrost (👤) mode.

**Operation Tips**

- To keep dust or unpleasant fumes from entering the vehicle through the ventilation system, temporarily set the air intake control to the recirculation mode. Return the control to Fresh mode when the unpleasant air outside has diminished. This will help keep the driver alert and comfortable.
- To help prevent the inside of the windshield from fogging, set the air intake control to fresh mode and the fan speed to the desired position, turn on the air conditioning system, and adjust the temperature control to the desired temperature.

### Air conditioning

Your Genesis Branded Vehicle air conditioning system is filled with R-134a or R-1234yf refrigerant.

1. Start the vehicle.
2. Touch the A/C icon.
3. Set the mode to the Face Level (👤) mode.
4. Set the air intake control to Recirculation mode temporarily to allow the cabin to cool quickly. When the desired temperature in the cabin is reached, change the air intake control back to Fresh mode.
5. Adjust the fan speed control and temperature control to maintain maximum comfort.

When maximum cooling is desired, set the temperature control to the lowest position, then set the fan speed control to the highest setting.

#### **NOTICE**

**When using the air conditioning system, monitor the temperature gauge closely while driving up hills or in heavy traffic when outside temperatures are high.**

**Air conditioning system operation when climbing a steep grade or in high outside ambient temperatures can cause vehicle overheating.**

**Continue to use the fan, but turn the air conditioning system off if the temperature gauge indicates vehicle overheating.**

### Air conditioning system operation tips

- If the vehicle has been parked in direct sunlight during hot weather, open the windows for a short time to let the hot air inside the vehicle escape.
- After sufficient cooling has been achieved, switch back from recirculation mode to fresh mode.
- To help reduce moisture inside of the windows on rainy or humid days, decrease the humidity inside the vehicle by operating the air conditioning system with the windows and sunroof closed.
- Use the air conditioning system every month only for a few minutes to ensure maximum system performance.
- If you operate air conditioner excessively, the difference between the temperature of the outside air and that of the windshield could cause the outer surface of the windshield to fog up, causing loss of visibility. In this case, set the mode selection to the 🌬️ position and fan speed control to the lowest speed.

## System maintenance

### Cabin air filter

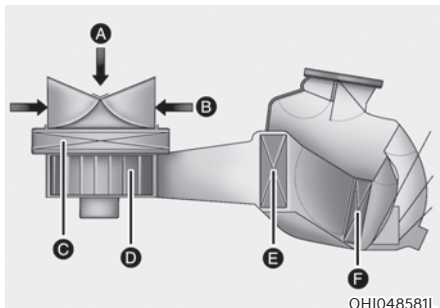

[A]: Outside air, [B]: Recirculated air  
 [C]: Climate control air filter, [D]: Blower  
 [E]: Evaporator core, [F]: Heater core

The cabin air filter is installed behind the glove box. It filters the dust or other pollutants that enter the vehicle through the heating and air conditioning system.

We recommend that the cabin air filter be replaced by an authorized retailer of Genesis Branded products according to the maintenance schedule. If the vehicle is being driven in severe conditions such as dusty or rough roads, more frequent cabin air filter inspections and changes are required.

If the air flow rate suddenly decreases, we recommend that the system be inspected at an authorized retailer of Genesis Branded products.

### Checking the amount of air conditioner refrigerant and compressor lubricant

When the amount of refrigerant is low, the performance of the air conditioning is reduced. Overfilling also reduces the performance of the air conditioning system.

Therefore, if abnormal operation is found, we recommend that the system be inspected by an authorized retailer of Genesis Branded products.

### NOTICE

**It is important that the correct type and amount of oil and refrigerant are used. Otherwise, damage to the compressor and abnormal system operation may occur. To prevent damage, the air conditioning system in your vehicle should only be serviced by trained and certified technicians.**



### WARNING

**Vehicles equipped with R-134a**



**Since the refrigerant is operated at very high pressure, the air conditioning system should only be serviced by trained and certified technicians.**

**All refrigerants should be reclaimed with proper equipment.**

**Venting refrigerants directly to the atmosphere is harmful to individuals and environment. Failure to heed these warnings can lead to serious injuries.**

**⚠ WARNING**

Vehicles equipped with R-1234yf



Since the refrigerant is mildly flammable and operated at high pressure, the air conditioning system should only be serviced by trained and certified technicians. It is important that the correct type and amount of oil and refrigerant are used.

All refrigerants should be reclaimed with proper equipment.

Venting refrigerants directly to the atmosphere is harmful to individuals and environment. Failure to heed these warnings can lead to serious injuries.



OJKEV051121

**Air Conditioning refrigerant label**

You can find out which air conditioning refrigerant is applied to your vehicle on the label located inside of the hood.

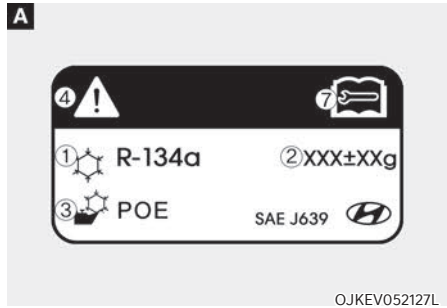

OJKEV052127L

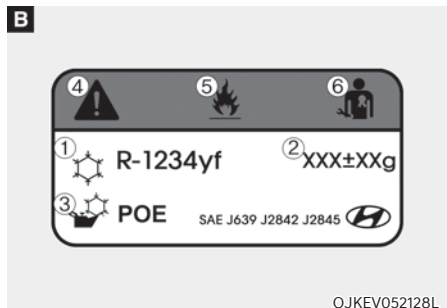

OJKEV052128L

Each symbols and specification on the air conditioning refrigerant label is represented as below:

- (1) Classification of refrigerant
- (2) Amount of refrigerant
- (3) Classification of compressor lubricant
- (4) Caution
- (5) Flammable refrigerant
- (6) To require registered technician to service air conditioning system
- (7) Service manual





## WINDSHIELD DEFROSTING AND DEFOGGING



### WARNING

#### Windshield heating

Do not use the  position during cooling operation in extremely humid weather. The difference between the temperature of the outside air and that of the windshield could cause the outer surface of the windshield to fog up, causing loss of visibility could cause an accident resulting in serious injury or death. In this case, set the mode selection to the  position and fan speed control to a lower speed.

- For maximum defrost performance, set the temperature control to the highest temperature setting and the fan speed control to the highest setting.
- If warm air to the floor is desired while defrosting or defogging, set the mode to the floor-defrost position.
- Before driving, clear all snow and ice from the windshield, rear window, outside rearview mirrors, and all side windows.
- Clear all snow and ice from the hood and air inlet in the cowl grill to improve heater and defroster efficiency and to reduce the probability of fogging up the inside of the windshield.

### NOTICE

If the vehicle temperature is still cold after starting, then a brief vehicle warm up period may be required for the vented air flow to become warm or hot.

#### To defog inside windshield

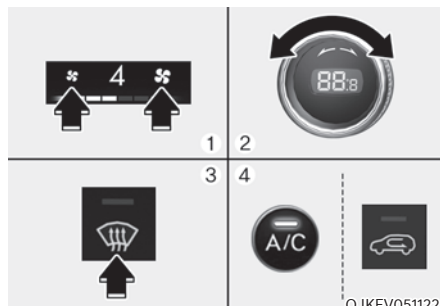

1. Select the desired fan speed.
2. Select the desired temperature.
3. Press the defroster button (.
4. Fresh mode will be selected automatically.

Check to make sure the air intake control is in Fresh mode. If the air intake control indicator light is illuminated, press the button once to enable Fresh mode (indicator light OFF).

If the  position is selected, the fan speed is automatically increased.

### To defrost outside windshield

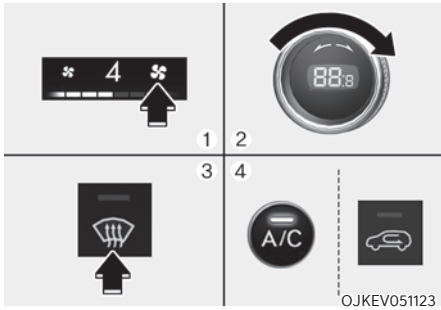

1. Set the fan speed to the highest (extreme right) position.
2. Set the temperature to the extreme hot (HI) position.
3. Press the defroster button (☀️).
4. Fresh mode will be selected automatically.

Check to make sure the air intake control is in Fresh mode. If the air intake control indicator light is illuminated, press the button once to enable Fresh mode (indicator light OFF).

If the ☀️ position is selected, lower fan speed is adjusted to a higher fan speed.

### Defogging logic

To reduce the probability of fogging up the inside of the windshield, the air intake or air conditioning are controlled automatically according to certain conditions such as ☀️ positions. To cancel or reset the defogging logic, do the following.

1. Press the Start/Stop button to the ON position.
2. Press the defroster button (☀️) or (🌀).
3. While touching the A/C icon, press the air intake control button at least 5 times within 3 seconds.

The air intake control indicator will blink 3 times to indicate that the defogging logic has been disabled. Repeat the steps again to re-enable the defogging logic.

If the battery has been discharged or disconnected, it resets to the defog logic status.

## Rear window defroster

### NOTICE

To prevent damage to the rear window defroster conducting elements bonded to the inside surface of the rear window, never use sharp instruments or window cleaners containing abrasives to clean the window.



OJKEV051124

The defroster heats the window to remove frost, fog and thin ice from the interior and exterior of the rear window, while the READY indicator is on.

- To activate the rear window defroster, press the rear window defroster button located in the center control panel. The indicator on the rear window defroster illuminates when the defroster is on.
- To turn off the defroster, press the rear window defroster button again.

### *i* Information

- If there is heavy accumulation of snow on the rear window, brush it off before operating the rear defroster.
- The rear window defroster automatically turns off after approximately 20 minutes or when the Start/Stop button is in the OFF position.

### *Outside rearview mirror defroster*

If your vehicle is equipped with the rearview mirror defrosters, they will operate at the same time you turn on the rear window defroster.

## CLIMATE CONTROL ADDITIONAL FEATURES

### Auto defogging system

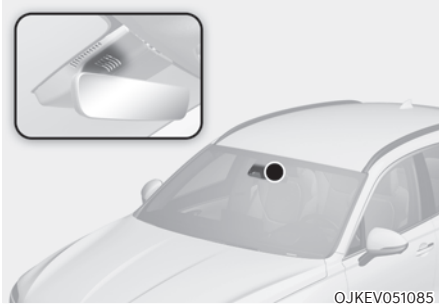

Auto defogging helps reduce the possibility of fogging up the inside of the windshield by automatically sensing the moisture on inside the windshield.

The auto defogging system operates when the heater or air conditioning is on.

#### Information

**The auto defogging system may not operate normally, when the outside temperature is below -10 °C (14 °F).**



When the Auto Defogging System operates, the indicator will illuminate.

If a high amount of humidity is detected in the vehicle, the Auto Defogging System will be enabled. The following steps will be performed automatically:

- Except Europe

Step 1) Air conditioning will turn ON.

Step 2) Air intake control will change to Fresh mode.

Step 3) Mode will change to defrost to direct airflow to the windshield.

Step 4) Fan speed will be set to MAX.

- For Europe

Step 1) Air conditioning will turn ON.

Step 2) Air intake control will change to Fresh mode.

Step 3) Fan speed will be set to MAX.

Step 4) Mode will change to defrost to direct airflow to the windshield.

If the air conditioning is off or recirculation mode is manually selected while Auto Defogging System is ON, the Auto Defogging System indicator will blink 3 times to signal that the manual operation has been canceled.

### **Turning the Auto Defogging System ON or OFF**

#### **Climate control system**

Press the front windshield defroster button for 3 seconds when the Start/Stop button is in the ON position. When the Auto Defogging System is turned off, the ADS OFF symbol will blink 3 times and ADS OFF will be displayed on the climate control information screen.

When the Auto Defogging System is turned on, the ADS OFF symbol will blink 6 times without a signal.

#### **Infotainment system**

Auto Defogging System can be turned on and off by selecting 'Setup → Vehicle Settings → Climate → Defog/Defrost Options → Auto Defog' from the infotainment system screen.

For detailed information, scan the QR code in a separately supplied simple manual.



### **Information**

- **When the air conditioning is turned on by Auto Defogging System, if you try to turn off the air conditioning, the indicator will blink 3 times and the air conditioning will not be turned off.**
- **To maintain the effectiveness and efficiency of the Auto Defogging System, do not select Recirculation mode while the system is operating.**
- **When Auto Defogging System is operating, fan speed adjustment, temperature adjustment, and air intake control selection are all disabled.**

### **NOTICE**

**Do not remove the sensor cover located on the upper end of the windshield glass.**

**Damage to system parts could occur and may not be covered by your vehicle warranty.**

### **Auto dehumidify (if equipped)**

To increase cabin air quality and reduce windshield misting, recirculation mode switches off automatically after about 5 to 30 minutes, depending on the outside temperature, and the air intake will change to fresh mode.

### **Turning Auto Dehumidify ON or OFF**

#### **Climate control system**

To turn the Auto Dehumidify feature on or off, select Face level (👤) mode and press the air intake control (👉) button at least five times within three seconds. When Auto Dehumidify is turned on, the air intake control button indicator will blink 6 times. When turned off, the indicator will blink 3 times.

#### **Infotainment system**

Auto Dehumidify can be turned on and off by selecting 'Setup → Vehicle Settings → Climate → Automatic Ventilation → Auto Dehumidify' from the infotainment system screen.

For detailed information, scan the QR code in a separately supplied simple manual.

### **Recirculating air when washer fluid is used**

Recirculation mode automatically activates to reduce any objectionable scent of the washer fluid from entering the cabin when the windshield washer is used.

#### ***Turning Activate upon Washer Fluid Use ON or OFF***

##### **Climate control system**

To turn the Activate upon Washer Fluid Use feature on or off, select Floor level (🚶) mode, and then press the air intake control (🌀) button four times within two seconds while pressing the A/C icon.

When Activate upon Washer Fluid Use ON is turned on, the air intake control button indicator will blink 6 times. When turned off, the indicator will blink 3 times.

##### **Infotainment system**

Activate upon Washer Fluid Use can be turned on and off by selecting 'Setup → Vehicle Settings → Climate → Recirculate Air → Activate upon Washer Fluid Use (or Interlocking washer fluid)' from the infotainment system screen.

For detailed information, scan the QR code in a separately supplied simple manual.

However, in cold weather to prevent the windshield from fogging up, the recirculation mode may not be selected.

### **Auto. Controls That Use Climate Control Settings (for driver's seat)**

The temperature of the driver's seat warmer, air ventilated seat and heated steering wheel is automatically controlled depending on the inside and outside temperature of the vehicle when the READY indicator is on.

To use these features, it must be enabled from the Settings menu in the infotainment system screen. Select:

- Setup → Vehicle Settings → Seat → Heated/Ventilated Features → Heated/Ventilated Features → Auto. Controls That Use Climate Control Settings

For more details on Auto Comfort Control, refer to "Seat Warmers" and "Air ventilation seats" section in chapter 3 and "Heated Steering Wheel" section in this chapter.

### ***Recirculation mode plus (if equipped)***

- To prevent the inflow of polluted air into the vehicle when passing through a tunnel, this function automatically closes the windows and switches the climate control system to Recirculation mode for about 7 seconds before entering a tunnel based on the map information of the navigation and the speed of the vehicle.
- The windows automatically closes before entering a tunnel and area requiring air recirculation. The windows open to the previous position after passing the area. If the power window switch is operated before the window opens, the window does not open to the previous position.
- To use this feature, it must be enabled from the Settings menu in the infotainment system.  
Select:
  - Setup → Vehicle → Climate → Internal air circulation → TunnelSee additional information in supplied Infotainment Manual.

### **Operating Condition**

- Type of road: Freeway, highway, expressway
- Vehicle status: One or more of the windows are opened or fresh mode is selected

### ***i* Information**

- **The activation time for the recirculation mode may differ depending on the gap between the GPS data and vehicle speed.**
- **The function will not activate again when tunnels exist continuously.**
- **When entering a tunnel, recirculation mode may cause fogging of the windshield. Press the windshield defrosting button.**
- **After exiting the tunnel, fresh mode may be selected depending on the air condition inside the vehicle.**
- **The function does not operate in tunnels within 50m in length.**
- **The function may not activate if the GPS is not working properly.**

## STORAGE COMPARTMENT

### WARNING

Never store cigarette lighters, propane cylinders, or other flammable/explosive materials in the vehicle. These items may catch fire and/or explode if the vehicle is exposed to hot temperatures for extended periods.

### WARNING

**ALWAYS** keep the storage compartment covers closed securely while driving. Items inside your vehicle are moving as fast as the vehicle. If you have to stop or turn quickly, or if there is a crash, the items may fly out of the compartment and may cause an injury if they strike the driver or a passenger.

### **NOTICE**

To avoid possible theft, do not leave valuables in the storage compartments.

## Center console storage



To open:  
Press the button.

## Glove box

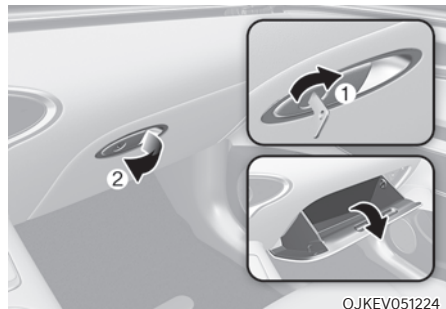

The glove box can be locked and unlocked with the mechanical key (1).

To open:  
Pull the lever (2).

### WARNING

**ALWAYS** close the glove box door after use.

An open glove box door can cause serious injury to the passenger in an accident, even if the passenger is wearing a seat belt.



## Sunglass holder (if equipped)



To open:

Push and release the cover and the holder will slowly open. Place your sunglasses in the compartment door with the lenses facing out.

To close:

Push back into position.

Make sure the sunglass holder is closed while driving.



### WARNING

- Do not keep objects except sunglasses inside the sunglass holder. Such objects can be thrown from the holder in the event of a sudden stop or an accident, possibly injuring the passengers in the vehicle.
- Do not open the sunglass holder while the vehicle is moving. The rear view mirror of the vehicle can be blocked by an open sunglass holder.
- Do not put the glasses forcibly into a sunglass holder. It may cause personal injury if you try to open it forcibly when the glasses are jammed in holder.

## Mobile phone holder



Store your phone or other small items while driving.

### NOTICE

The item you have stored such as a mobile phone may not fit in the mobile phone holder depending on the size or shape of the item. Do not forcibly push items into the holder and close the cover. The mobile phone holder may not open, or it may damage the stored item. In addition, do not forcibly open the mobile phone storage cover, when it is jammed with a stored item inside.

## INTERIOR FEATURES

### Cup holder

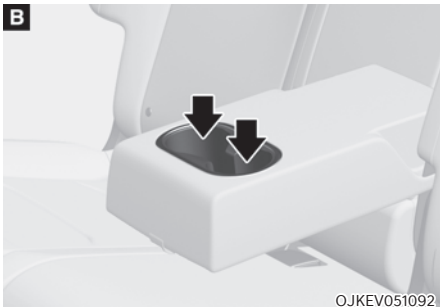
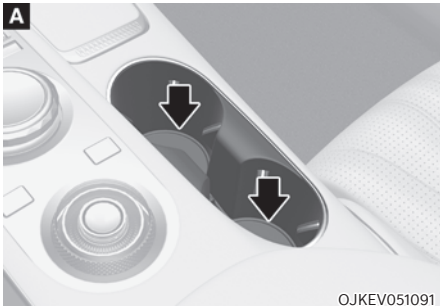

[A]: Front seat, [B]: Rear seat

Cups or small beverages cups may be placed in the cup holders.

### WARNING

- Avoid abrupt starting and braking when the cup holder is in use to prevent spilling your drink. If hot liquid spills, you could be burned. Such a burn to the driver could cause loss of vehicle control resulting in an accident.
- Do not place uncovered or unsecured cups, bottles, cans, etc., in the cup holder containing hot liquid while the vehicle is in motion. Injuries may result in the event of a sudden stop or collision.
- Only use soft cups in the cup holders. Hard objects can injure you in an accident.

### WARNING

Keep cans or bottles out of direct sun light and do not put them in a hot vehicle. It may explode.

### NOTICE

- Keep your drinks sealed while driving to prevent spilling your drink. If liquid spills, it may get into the vehicle's electrical/electronic system and damage electrical/electronic parts.
- When cleaning spilled liquids do not use hot air to blow out or dry the cup holder. This may damage the interior.

## Ashtray (if equipped)



OJKEV052255L

To open cover:

Press the cover and it will slowly open.

To clean the ashtray:

The plastic receptacle should be removed by lifting the plastic ashtray receptacle upward and pulling it out.



### WARNING

**Putting lit cigarettes or matches in an ashtray with other combustible materials may cause a fire.**

## Sunvisor

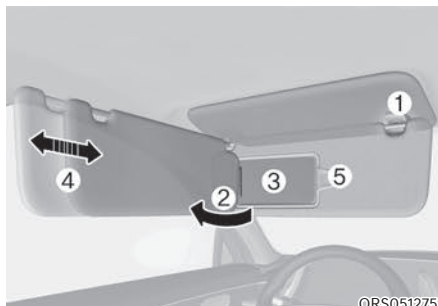

©RS051275

To use the sunvisor, pull it downward.

To use the sunvisor to block the sun from the side window, pull it downward, release it from the bracket (1) and swing it to the side (2) towards the window.

To use the vanity mirror, pull down the sunvisor and slide the mirror cover (3).

Adjust the sunvisor forward or backward (4) as needed (if equipped). Use the ticket holder (5) to hold tickets.

Close the vanity mirror cover securely and return the sunvisor to its original position after use.



### WARNING

**For your safety, do not block your view when using the sunvisor.**

### NOTICE

**The tab (5) adjacent to the vanity mirror on the sunvisor can be used for toll road tickets or self parking tickets. Use caution when inserting tickets into the ticket holder to avoid damage. Refrain from putting several tickets in the ticket holder as this could also damage the retaining tab.**

## Power outlet



[A]: Front seat, [B]: Luggage compartment

The power outlet is designed to provide power for mobile telephones or other devices designed to operate with vehicle electrical systems. The devices should draw less than 180 watts with the READY indicator on.

### **WARNING**

Avoid electrical shocks. Do not place your fingers or foreign objects (pin, etc.) into a power outlet or touch the power outlet with a wet hand.

### **NOTICE**

To prevent damage to the power outlets:

- Use the power outlet only when the **READY** indicator is on and remove the accessory plug after use. Using the accessory plug for prolonged periods of time with the **READY** indicator off could cause the battery to discharge.
- Only use 12 volts electric accessories which are less than 180 watts in electric capacity.
- Adjust the air-conditioner or heater to the lowest operating level when using the power outlet.
- Close the cover when not in use.
- Some electronic devices can cause electronic interference when plugged into a vehicle's power outlet. These devices may cause excessive audio static and malfunctions in other electronic systems or devices used in your vehicle.
- Push the plug in as far as it will go. If good contact is not made, the plug may overheat and the fuse may open.
- Plug in battery equipped electrical/electronic devices with reverse current protection. The current from the battery may flow into the vehicle's electrical/electronic system and cause system malfunction.

## USB charger (if equipped)

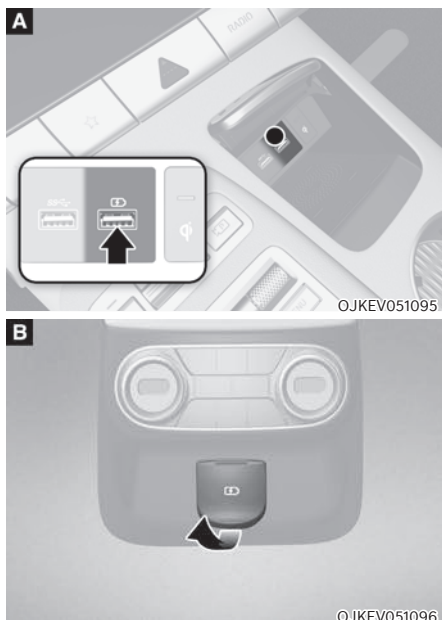

[A]: Front, [B]: Rear

The USB charger is designed to recharge batteries of small size electrical devices using a USB-Cable.

The electrical devices can be recharged when the Start/Stop button is in the ON or START position.

The battery charging state may be monitored on the electrical device.

Disconnect the USB cable from the USB port after use.

- A smart phone or a tablet PC may get warmer during the re-charging process. It does not indicate any malfunction with the charging system.
- A smart phone or a tablet PC, which adopts a different re-charging method, may not be properly re-charged. In this case, use an exclusive charger of your device.
- The charging terminal is only to recharge a device. Do not use the charging terminal either to turn ON an audio or to play media in the infotainment system.

### NOTICE

- **Use the USB charger when the READY indicator is on. Using the USB charger for prolonged periods of time with the READY indicator off could cause the battery to discharge.**
- **To prevent damage to the USB charger:**
  - **Do not insert foreign objects or spill liquid into the outlet. The USB charging terminal may be damaged.**
  - **Do not use devices with current consumption exceeding 2,100 mA (2.1 A).**

### **i** Information

**Charging may not be possible when using a Type-C converter sold by a mobile phone manufacturer or commercially available.**

## Wireless smart phone charging system (if equipped)

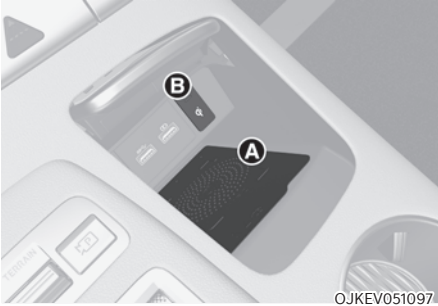

[A]: Charging pad, [B]: Indicator light

On certain models, the vehicle comes equipped with a wireless smart phone charger.

### Charging smart phone

The wireless smart phone charging system charges only the Qi-enabled smart phones (❶). Read the label on the smart phone accessory cover or visit your smart phone manufacturer's website to check whether your smart phone supports the Qi technology.

The wireless charging process starts when you put a Qi-enabled smart phone on the wireless charging unit.

1. The system is available when all doors are closed, and when the Start/Stop button is in the ON (or START) position.
2. You can turn on or off the wireless charging function from the Settings menu in the infotainment system screen. Select:
  - Setup → Vehicle → Convenience → Wireless Charging

For detailed information, scan the QR code in a separately supplied simple manual.

3. The indicator light is orange when the smart phone is charging. The indicator light will turn blue when phone charging is complete.

### Information

**Remove other items, including the smart key, from the wireless charging unit. If not, the wireless charging process may be interrupted.**

If your smart phone is not charging:

- Slightly change the position of the smart phone on the charging pad.
- Make sure the indicator light is orange.

The indicator light will blink orange for 10 seconds if there is a malfunction in the wireless charging system.

In this case, temporarily stop the charging process, and re-attempt to charge your smart phone again.

The system warns you with a message on the LCD display if the smart phone is still on the wireless charging unit after the vehicle is turned OFF and the front door is opened.

For some manufacturer's smart phones, the system may not warn you even though the smart phone is left on the wireless charging unit. This is due to the particular characteristic of the smart phone and not a malfunction of the wireless charging.

### **i** Information

- The wireless smart phone charging system may not support certain smart phones, which are not verified for the Qi specification (Qi).
- When placing your smart phone on the charging pad, position the phone in the middle of the mat for optimal charging performance. If your smart phone is off to the side, the charging rate may be less and in some cases the smart phone may experience higher heat conduction.
- In some cases, the wireless charging may stop temporarily when the smart key is used, either when starting the vehicle or locking/unlocking the doors, etc.
- When charging certain smart phones, the charging indicator may not change to blue when the smart phone is fully charged.
- The wireless charging process may temporarily stop, when temperature abnormally increases inside the wireless smart phone charging system. The wireless charging process restarts, when temperature falls to a certain level.
- The wireless charging process may temporarily stop when there is any metallic item, such as a coin, between the wireless smart phone charging system and smart phone.
- When charging some smart phones with a self-protection feature, the wireless charging speed may decrease and the wireless charging may stop.
- If the smart phone has a thick cover, the wireless charging may not be possible.
- If the smart phone is not completely contacting the charging pad, wireless charging may not operate properly.
- If the Start/Stop button is in the OFF position, the charging also stops.
- When any smart phone without a wireless charging function or a metallic object is placed on the charging pad, a small noise may sound. This small sound is due to the vehicle discerning compatibility of the object placed on the charging pad. It does not affect your vehicle or the smart phone in any way.
- Some smart phones may not be able to charge depending on the internal structure of the smart phone. If this occurs, try charging the mobile phone by moving it to the left or right side of the wireless charging pad. However, for some foldable smart phones that have magnets inside the smart phone, try charging the smart phone while holding it close to the left side of the wireless charging pad.

### **NOTICE**

Some magnetic items like credit cards, phone cards or rail tickets may be damaged if left with the smart phone during the charging process.

### Clock

The clock can be set from the infotainment system.  
For detailed information, scan the QR code in a separately supplied simple manual.

#### **WARNING**

**Do not attempt to adjust the clock while driving. Doing so may result in distracted driving which may lead to an accident involving personal injury or death.**

### Coat hook



These hooks are not designed to hold large or heavy items.

#### **WARNING**



**Do not hang other objects such as hangers or hard objects except clothes. Also, do not put heavy, sharp or breakable objects in the clothes pockets. In an accident or when the curtain air bag is inflated, it may cause vehicle damage or personal injury.**

### Floor mat anchor(s)

ALWAYS use the Floor Mat Anchors to attach the front floor mats to the vehicle. The anchors on the front floor carpet keep the floor mats from sliding forward.

#### **WARNING**

**Do not overlay additional mats or liners over the floor mats. If using All Weather mats, remove the carpeted floor mats before installing them. Only use floor mats designed to connect to the anchors.**



**WARNING**

The following must be observed when installing ANY floor mat to the vehicle.

- Ensure to remove a protective film attached on the carpet before attaching a floor mat on the front floor carpet. Otherwise, the floor mat may move freely on the protective film and it could result in unintentional braking or accelerating.
- Ensure that the floor mats are securely attached to the vehicle's floor mat anchor(s) before driving the vehicle.
- Do not use ANY floor mat that cannot be firmly attached to the vehicle's floor mat anchors.
- Do not stack floor mats on top of one another (for example, all-weather rubber mat on top of a carpeted floor mat). Only a single floor mat should be installed in each position.

**NOTICE**

Your vehicle was manufactured with driver's side floor mat anchors that are designed to securely hold the floor mat in place. To avoid any interference with pedal operation, Genesis Branded Vehicle recommends that the Genesis floor mat designed for use in your vehicle be installed.

### Rear side window sunshades (if equipped)

Use the rear side window sunshade to block external light coming through the rear window glass.

#### Manual sunshades

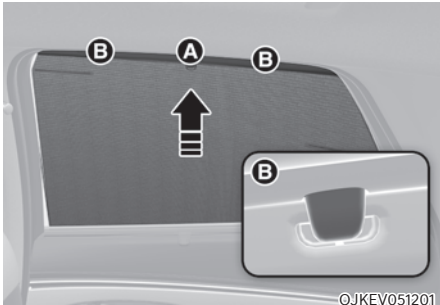

1. Lift the sunshade by the handle (A).
2. Hang the sunshade on both sides of the hook (B). If the sunshade is hung on one side of the hook, the sunshade may be wrinkled.

#### NOTICE

- Do not hang any other object except the rear side window sunshade on the hooks.
- If you pull the rear side window sunshade or apply force to return the sunshade to its original position after use, you may find the sunshade wrinkled or out of shape. To lower the sunshade, be sure to put the handle downward and slowly return the sunshade to its original position.
- Sunshades may not work properly if foreign objects (coins, toys, cookies, etc.) are stuck in the door. Be careful that the foreign objects do not get into the door.

### Luggage net holder (if equipped)



To keep items from shifting in the luggage compartment, you can use the 4 holders located in the luggage board to attach the luggage net.

Make sure the luggage net is securely attached to the holders in the luggage board.

If necessary, we recommend that you contact your authorized retailer of Genesis Branded products to obtain a luggage net.

#### WARNING

Avoid eye injury. **DO NOT** overstretch the luggage net. **ALWAYS** keep your face and body out of the luggage net's recoil path. **DO NOT** use the luggage net when the strap has visible signs of wear or damage.

Use the luggage net to keep only light items from shifting in the luggage compartment.

## Cargo security screen (if equipped)

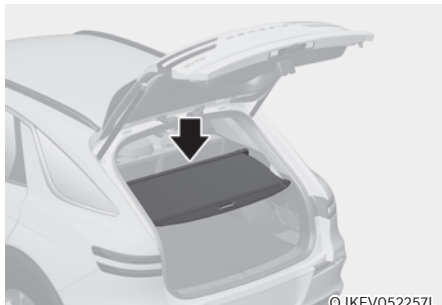

OJKEV052257L

Use the cargo security screen to cover items stored in the cargo area.

### Using the cargo security screen

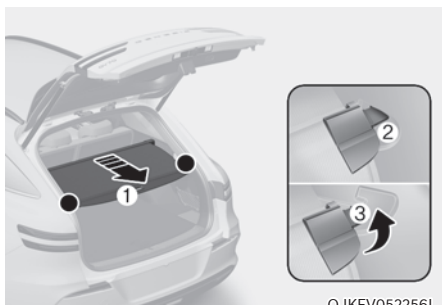

OJKEV052256L

1. Pull the cargo security screen towards the rear of the vehicle by the handle (1).
2. Insert the guide pin (2) into the guide (3).

### **i** Information

Pull out the cargo security screen with the handle in the center to prevent the guide pin from falling out of the guide.

When the cargo security screen is not in use:

1. Pull the cargo security screen rearward and up to release it from the guides.
2. The cargo security screen will automatically slide back in.

### **i** Information

The cargo security screen may not automatically slide back in if the cargo security screen is not fully pulled out. Pull the cargo screen out all the way and then slowly allow the screen to retract back in.

### **NOTICE**

Since the cargo security screen may be damaged or malformed, do not put luggage on it when it is used.

### **!** WARNING

- Do not place objects on the cargo security screen. Such objects may be thrown about inside the vehicle and possibly injure vehicle occupants during an accident or when braking.
- Never allow anyone to ride in the luggage compartment. It is designed for luggage only.
- Maintain the balance of the vehicle and locate the weight as forward as possible.

### Removing the cargo security screen

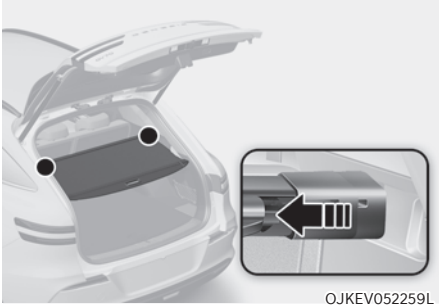

1. Push one side of the cargo screen inward to compress the spring and release the screen from the vehicle.
2. While the spring is compressed, pull out the cargo security screen.
3. Open the luggage tray and keep the cargo security screen in the tray.

### Removing the cargo security screen from the luggage tray

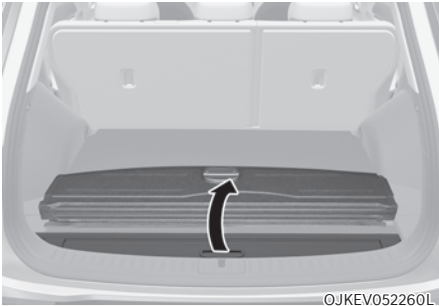

1. Pull up the screen board.

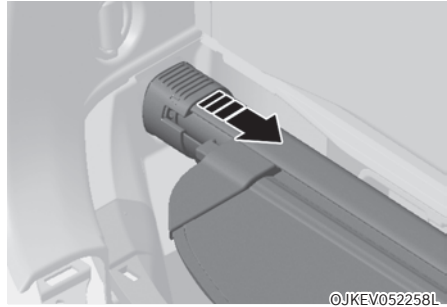

2. Push in the guide pin.

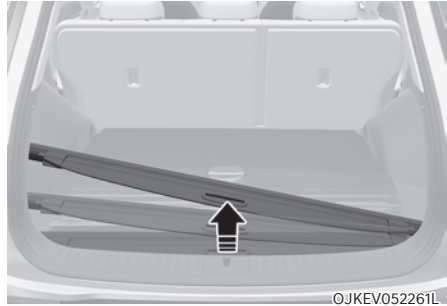

3. While pushing the guide pin, pull out the cargo security screen.

## EXTERIOR FEATURES

### Roof side rails

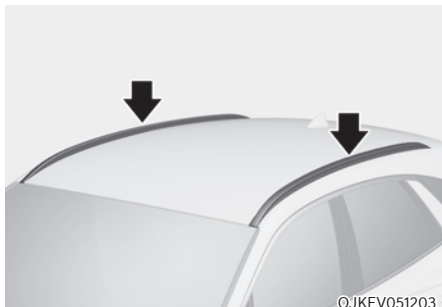

©JKEV051203

If your vehicle comes with roof side rails, then roof side rails crossbars can be installed on top of your vehicle.

The roof side rails crossbars are an accessory and are available at your local retailer of Genesis Branded products.

#### NOTICE

If the vehicle is equipped with a sunroof, be sure not to position cargo onto the roof side rails in such a way that it could interfere with sunroof operation.

#### NOTICE

- When carrying cargo on the roof side rails, take the necessary precautions to make sure the cargo does not damage the roof of the vehicle.
- When carrying large objects on the roof side rails, make sure they do not exceed the overall roof length or width.



#### WARNING

- The following specification is the maximum weight that can be loaded onto the roof side rails. Distribute the load as evenly as possible onto the roof side rails and secure the load firmly.

Loading cargo or luggage in excess of the specified weight limit on the roof side rails may damage your vehicle.

ROOF SIDE RAILS	100 kg (220 lbs.) EVENLY DISTRIBUTED
-----------------	---

- The vehicle center of gravity will be higher when items are loaded onto the roof side rails. Avoid sudden starts, braking, sharp turns, abrupt maneuvers or high speeds that may result in loss of vehicle control or rollover resulting in an accident.
- Always drive slowly and turn corners carefully when carrying items on the roof side rails. Severe wind updrafts, caused by passing vehicles or natural causes, can cause sudden upward pressure on items loaded on the roof side rails. This is especially true when carrying large, flat items such as wood panels or mattresses. This could cause the items to fall off the roof side rails and cause damage to your vehicle or others around you.
- To prevent damage or loss of cargo while driving, check frequently before or while driving to make sure the items on the roof side rails are securely fastened.

## INFOTAINMENT SYSTEM

### NOTICE

- If you install an aftermarket HID head lamp, your vehicle's audio and electronic devices may not function properly.
- Prevent chemicals such as perfume, cosmetic oil, sun cream, hand cleaner, and air freshener from contacting the interior parts because they may cause damage or discoloration.

### USB Port



You can use a USB cable to connect audio devices to the vehicle USB port.

### **i** Information

When using a portable audio device connected to the power outlet, noise may occur during playback. If this happens, use the portable audio device's power source.

### Antenna

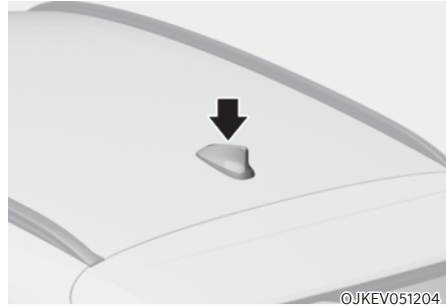

The shark fin antenna will receive AM, FM broadcast signals and transmit data.

### Steering wheel remote controls

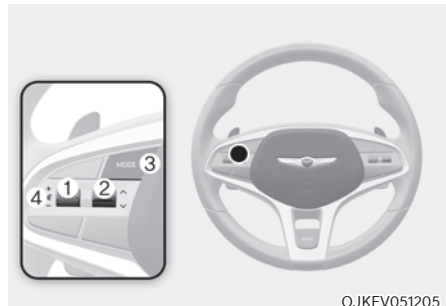

### NOTICE

Do not operate multiple audio remote control buttons simultaneously.

**VOLUME (VOL + / VOL -) (1)**

- Rotate the VOLUME scroll up to increase volume.
- Rotate the VOLUME scroll down to decrease volume.

**SEEK/PRESET (∧ / ∨) (2)**

If the SEEK/PRESET switch is pressed up or down and held for 0.8 second or more, it will function in the following modes:

- **RADIO mode**  
It will function as the AUTO SEEK select button. It will SEEK until you release the button.
- **MEDIA mode**  
It will function as the FF/RW button.

If the SEEK/PRESET switch is pressed up or down, it will function in the following modes:

- **RADIO mode**  
It will function as the PRESET STATION UP/DOWN button.
- **MEDIA mode**  
It will function as the TRACK UP/DOWN button.

**MODE (3)**

Press the MODE button to toggle through Radio modes.

**MUTE (🔇) (4)**

- Press the MUTE(🔇) button to mute or activate the sound.

For detailed information, scan the QR code in a separately supplied simple manual.

**Infotainment system**

OJKEV051228

For detailed information, scan the QR code in a separately supplied simple manual.

**Voice recognition**

OJKEV051209

For detailed information, scan the QR code in a separately supplied simple manual.

### Bluetooth® Wireless Technology

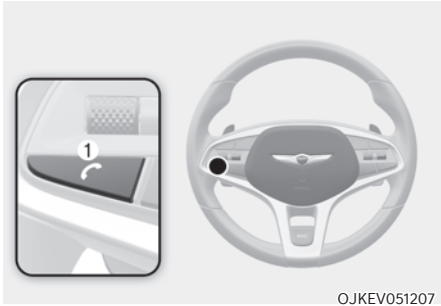

- (1) Call/Answer/Call end button
- (2) Microphone

For detailed information, scan the QR code in a separately supplied simple manual.

### CAUTION

To avoid driver distractions, do not excessively operate the device while driving the vehicle which may lead to an accident.

### Lexicon premium sound system (if equipped)

#### CAUTION

Lexicon premium sound system is equipped with speaker grills made of stainless steel. The grill surface can be heated when the vehicle is exposed to hot weather for a long period of time. Keep away from the speaker grill when it is hot.



# 6. Driving your vehicle

Before driving.....	6-4
Before entering the vehicle .....	6-4
Before starting .....	6-4
Start/Stop button.....	6-5
Start/Stop button positions.....	6-6
Starting the vehicle .....	6-7
Turning off the vehicle .....	6-8
Remote start .....	6-9
Reduction gear.....	6-10
Reduction gear operation.....	6-10
LCD display messages (cluster).....	6-15
Good driving practices.....	6-17
Regenerative braking system (Paddle shifter).....	6-18
Using regenerative braking system.....	6-18
Regenerative braking system limitations .....	6-19
One Pedal Driving .....	6-19
Using i-PEDAL.....	6-21
Smart recuperation system.....	6-22
Smart recuperation system on/off.....	6-22
Smart recuperation system operating condition .....	6-23
Smart recuperation level settings .....	6-23
Pausing smart recuperation system .....	6-24
Front sensors (Front radar) .....	6-24
System warning due to sensor problems .....	6-25
Precautions for smart recuperation system .....	6-25

Braking system.....	6-29
Power-assist brakes .....	6-29
Disc brakes wear indicator .....	6-30
High performance brake.....	6-30
Electronic Parking Brake (EPB).....	6-31
Auto Hold .....	6-35
Brake Disc Cleaning .....	6-38
Anti-lock Brake System (ABS).....	6-39
Electronic Stability Control (ESC) .....	6-40
Vehicle Stability Management (VSM) .....	6-43
Trailer Stability Assist (TSA) .....	6-44
Hill-Start Assist Control (HAC).....	6-45
Emergency Stop Signal (ESS) .....	6-45
Multi-Collision Brake (MCB) .....	6-46
Brake Assistant System (BAS).....	6-47
Downhill Brake Control (DBC).....	6-47
Good braking practices.....	6-50
All Wheel Drive (AWD) .....	6-51
All Wheel Drive (AWD) operation .....	6-51
Emergency precautions.....	6-54
Electronic control suspension .....	6-56
System malfunction .....	6-56
Electronically controlled suspension with road preview .....	6-57
System malfunction .....	6-58
Limitations of the system .....	6-58
Drive mode integrated control system .....	6-59
Selecting drive mode.....	6-59
ECO, COMFORT, SPORT mode features.....	6-59
Drive modes characteristic.....	6-61
Selecting multi terrain mode.....	6-62
Boost Mode .....	6-63
Using Boost mode.....	6-63
Boost Mode limitations.....	6-63
Active noise control-road.....	6-63
System malfunction .....	6-63

Special driving conditions .....	6-64
Hazardous driving conditions .....	6-64
Rocking the vehicle.....	6-64
Smooth cornering .....	6-65
Driving at night.....	6-65
Driving in the rain .....	6-65
Driving in flooded areas.....	6-66
Highway driving .....	6-66
Reducing the risk of a rollover.....	6-67
Winter driving.....	6-68
Snow or icy conditions.....	6-68
Winter precautions.....	6-71
Trailer towing.....	6-73
If you decide to pull a trailer? .....	6-74
Trailer towing equipment.....	6-77
Driving with a trailer.....	6-78
Maintenance when towing a trailer .....	6-81
Vehicle weight.....	6-82
Overloading .....	6-82

## BEFORE DRIVING

### Before entering the vehicle

- Be sure all windows, outside mirror(s), and outside lights are clean and unobstructed.
- Remove frost, snow, or ice.
- Visually check the tires for uneven wear and damage.
- Check under the vehicle for any sign of leaks.
- Be sure there are no obstacles behind you if you intend to back up.

### Before starting

- Make sure the hood, the tailgate, and the doors are securely closed and locked.
- Adjust the position of the seat and steering wheel.
- Adjust the inside and outside rearview mirrors.
- Verify all the lights work.
- Fasten your seat belt. Check that all passengers have fastened their seat belts.
- Check the gauges and indicators in the instrument panel and the messages on the instrument display when the vehicle is in the ON position.
- Check that any items you are carrying are stored properly or fastened down securely.



### WARNING

To reduce the risk of **SERIOUS INJURY** or **DEATH**, take the following precautions:

- **ALWAYS** wear your seat belt. All passengers must be properly belted whenever the vehicle is moving. For more information, refer to “Seat Belts” section in chapter 3.
- Always drive defensively. Assume other drivers or pedestrians may be careless and make mistakes.
- Stay focused on the task of driving. Driver distraction can cause accidents.
- Leave plenty of space between you and the vehicle in front of you.



### WARNING

**NEVER** drink or take drugs and drive. Drinking or taking drugs and driving is dangerous and may result in an accident and **SERIOUS INJURY** or **DEATH**.

Drunk driving is the number one contributor to the highway death toll each year. Even a small amount of alcohol will affect your reflexes, perceptions and judgment. Just one drink can reduce your ability to respond to changing conditions and emergencies and your reaction time gets worse with each additional drink.

Driving while under the influence of drugs is as dangerous as or more dangerous than driving under the influence of alcohol.

You are much more likely to have a serious accident if you drink or take drugs and drive. If you are drinking or taking drugs, don't drive. Do not ride with a driver who has been drinking or taking drugs. Choose a designated driver or call a taxi.

## START/STOP BUTTON



Whenever the front door is opened, the Start/Stop button will illuminate and will go off 30 seconds after the door is closed.

### **WARNING**

To turn the vehicle off in an emergency: Press and hold the Start/Stop button for more than two seconds OR Rapidly press and release the Start/Stop button three times (within three seconds).

If the vehicle is still moving, you can restart the vehicle without depressing the brake pedal by pressing the Start/Stop button with the gear in the N (Neutral) position.

### **WARNING**

- **NEVER** press the Start/Stop button while the vehicle is in motion except in an emergency. This will result in the vehicle turning off and loss of power assist for the steering and brake systems. This may lead to loss of directional control and braking function, which could cause an accident.
- Before leaving the driver's seat, always make sure the gear is in the P (Park) position, set the parking brake, press the Start/Stop button to the OFF position, and take the Smart Key with you. Unexpected vehicle movement may occur if these precautions are not followed.
- **NEVER** reach through the steering wheel for the Start/Stop button or any other control while the vehicle is in motion. The presence of your hand or arm in this area may cause a loss of vehicle control resulting in an accident.

## Start/Stop button positions

Button Position	Action	Notes
<b>OFF</b>	<p>To turn off the vehicle, press the Start/Stop button with the vehicle shifted to P (Park).</p> <p>Note if the Start/Stop button is pressed with the vehicle shifted to D (Drive), R (Reverse) or N (Neutral), the gear will automatically shift to P (Park).</p> <p>If the Start/Stop button is pressed with the gear shifted to N (Neutral), the Start/Stop button will change to the ACC position.</p> <p>The steering wheel locks to protect the vehicle from theft.</p>	<p>If the steering wheel is not locked properly when you open the driver's door, the warning chime will sound.</p>
<b>ACC</b>	<p>Press the Start/Stop button when the button is in the OFF position without depressing the brake pedal.</p> <p>Some of the electrical accessories are usable.</p> <p>The steering wheel unlocks.</p>	<ul style="list-style-type: none"> <li>• If you leave the Start/Stop button in the ACC position for more than one hour, the battery power will turn off automatically to prevent the battery from discharging.</li> <li>• If the steering wheel doesn't unlock properly, the Start/Stop button will not work. Press the Start/Stop button while turning the steering wheel right and left to release.</li> </ul>
<b>ON</b>	<p>Press the Start/Stop button while it is in the ACC position without depressing the brake pedal.</p> <p>The warning lights can be checked before the vehicle is started.</p>	<p>Do not leave the Start/Stop button in the ON position when the vehicle is not running to prevent the battery from discharging.</p>
<b>START</b>	<p>To start the vehicle, depress the brake pedal and press the Start/ Stop button with the gear shifted to the P (Park) position.</p> <p>For your safety, start the vehicle with the gear shifted to the P (Park) position.</p>	<p>If you press the Start/Stop button without depressing the brake pedal, the vehicle does not start and the Start/Stop button changes as follows:  <b>OFF → ACC → ON → OFF or ACC</b></p>

\* To prevent vehicle battery discharge, the Start/Stop button changes to the OFF position when the Start/Stop button is in the ACC or ON position with the gear in P (Park) for a certain period of time. When the function operates, the tail lamps will turn off. To use the tail lamps again, turn the headlamp switch located on the steering column to the OFF and ON position again.

## Starting the vehicle



### WARNING

- Always wear appropriate shoes when operating your vehicle. Unsuitable shoes, such as high heels, ski boots, sandals, flipflops, etc., may interfere with your ability to use the brake and accelerator pedals.
- Do not start the vehicle with the accelerator pedal depressed. The vehicle can move which can lead to an accident.



### Information

- The vehicle will start by pressing the Start/Stop button, only when the smart key is in the vehicle.
- Even if the smart key is in the vehicle, and when it is far away from the driver, the vehicle may not start.
- When the Start/Stop button is in the ACC or ON position, if any door is open, the system checks for the smart key. When the smart key is not in the vehicle, the (  ) indicator will blink and the warning 'Key not in vehicle' will come on. When all doors are closed, the chime will also sound for about 5 seconds. Keep the smart key in the vehicle when in the ACC position or if the vehicle is in the ready (READY) mode.

## Starting the vehicle

1. Always carry the smart key with you.
2. Make sure the parking brake is applied.
3. Make sure the gear is in P (Park).
4. Depress the brake pedal.
5. Press the START/STOP button. If the vehicle starts, the (READY) indicator will come on.



### Information

- Always start the vehicle with your foot on the brake pedal. Do not depress the accelerator while starting the vehicle. Do not race the motor while warming it up.
- If ambient temperature is low, the (  ) indicator may remain illuminated longer than the normal amount of time.

### NOTICE

To prevent damage to the vehicle:

- If the (READY) indicator turns off while you are in motion, do not attempt to shift the gear to the P (Park) position.

If traffic and road conditions permit, you may put the gear in N (Neutral) while the vehicle is still moving and press the Start/Stop button in an attempt to restart the vehicle.

- Do not push or tow your vehicle to start the vehicle.

**NOTICE**

To prevent damage to the vehicle:  
Do not press the Start/Stop button for more than 10 seconds except when the stop lamp fuse is blown.

When the stop lamp fuse is blown, you cannot normally start the vehicle. Replace the fuse with a new one. If you are not able to replace the fuse, you can start the vehicle by pressing and holding the Start/Stop button for 10 seconds with the Start/Stop button in the ACC position.

Pressing the brake pedal many times while (READY) indicator light is off will increase the possibility of discharging the 12V battery.

For your safety always depress the brake pedal before starting the vehicle.

**CAUTION**

- Because the vehicle doesn't make the vehicle sound, pay attention to the surrounding environment and drive carefully.
- After parking or waiting for a traffic light, please check around(children, obstacle, etc.) before departure.
- When reversing, check directly behind you before driving. Pedestrians may not be able to recognize vehicle sounds.

*Emergency starting*



If the smart key battery is weak or the smart key does not work correctly, you can start the vehicle by pressing the Start/Stop button with the smart key in the direction of the picture above.

**Turning off the vehicle**

1. Stop the vehicle and depress the brake pedal fully.
2. Shift to P (Park).
3. Press the Start/Stop button to the OFF position and apply the parking brake.
4. Make sure the (READY) indicator light is off in the instrument cluster.

**CAUTION**

If the (READY) indicator light on the instrument cluster is still on, the vehicle is not turned off and can move when the gear is in any position except P (Park).



## Remote start (if equipped)



You can start the vehicle using the Remote Start button of the smart key.

To start the vehicle remotely:

1. Press the door lock button within 10 m (32 feet) from the vehicle.
2. Press the remote start (⌚) button for over 2 seconds within 4 seconds after locking the doors.
3. To turn off the remote start function, press the remote start (⌚) button once.
  - The remote start (⌚) button may not operate if the smart key is not within 10 m (32 feet).
  - The vehicle will not remotely start if the hood or tailgate is opened.
  - The vehicle must be in P (Park) for the remote start function to start.
  - The vehicle turns off if you get in the vehicle without a registered smart key.
  - The vehicle turns off if you do not get in the vehicle within 10 minutes after remotely starting the vehicle.

## REDUCTION GEAR

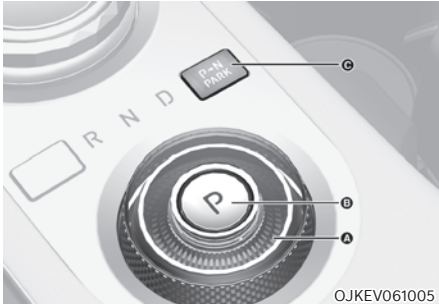

[A]: Rotary shifter (Rotary gear shift dial),  
[B]: P button, [C]: P→N PARK button

### Reduction gear operation

Depress the brake pedal whenever rotating the shift dial to change gear or selecting P.

### WARNING

To reduce the risk of serious injury or death:

- **ALWAYS** check the surrounding areas near your vehicle for people, especially children, before shifting a vehicle into D (Drive) or R (Reverse).
- Before leaving the driver's seat, always make sure the vehicle is shifted to the P (Park) position, then apply the parking brake, then press the Start/Stop button to the OFF position. Unexpected and sudden vehicle movement can occur if these precautions are not followed.

### Rotary shifter/Rotary gear shift dial P (Park)

Always come to a complete stop before shifting into P (Park).



OJKEV061006

To shift the gear to P (Park), press the P button while depressing the brake pedal. If you turn the vehicle off in R (Reverse), N (Neutral) or D (Drive), the gear will automatically shift to P (Park).



### WARNING

- **Shifting into P (Park) while the vehicle is in motion may cause you to lose control of the vehicle.**
- **After the vehicle has stopped, always make sure the vehicle is in P (Park), apply the parking brake, and turn the vehicle off.**
- **When parking on an incline, shift the gear to P (Park) and apply the parking brake to prevent the vehicle from rolling downhill.**

### **i** Information

**For vehicles equipped with the Electronic Parking Brake (EPB), EPB engages automatically when the gear is shifted to P (Park).**

#### Automatic gear shift to P (Park)

The gear is automatically shifted to P (Park), and the Electronic Parking Brake (EPB) applies automatically under the following conditions:

- When the vehicle is turned off with the gear in R (Reverse), D (Drive) or N (Neutral).
- When the driver's door is open with the vehicle in the ready (READY) mode, the gear in R (Reverse), D (Drive) or N (Neutral), and the vehicle at a standstill.
- When the driver's door is open with the gear in N (Neutral) and the vehicle is off.

In situations the gear must be in P (Park), always check if the gear is shifted to P (Park) by checking the cluster.

### R (Reverse)

Use this position to drive the vehicle rearward.



OJKEV061007

To shift the gear to R (Reverse), rotate the rotary gear shift dial to R (Reverse) while depressing the brake pedal.

When the vehicle is stopped in the R (Reverse) position, if you open the driver's door, the gear will automatically shift to P (Park).

However, if the vehicle is in motion, the gear may not automatically shift to P (Park) to prevent reduction gear damage.

The direction of the rotary gear shift dial is the same as that of the wheel.

### NOTICE

**Always come to a complete stop before shifting into or out of R (Reverse); you may damage the reduction gear if you shift into R (Reverse) while the vehicle is in motion.**

### N (Neutral)

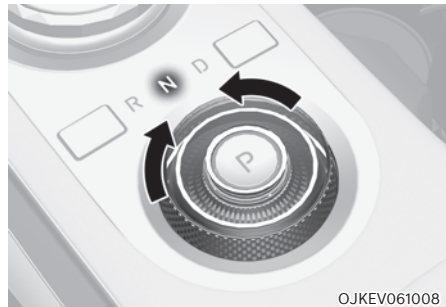

OJKEV061008

To shift the gear to N (Neutral), rotate the shift dial clockwise from R (Reverse) or counterclockwise from D (Drive) while depressing the brake pedal.

Always depress the brake pedal when you are shifting from N (Neutral) to another gear.

When the READY indicator is off with the gear in N (Neutral), the gear automatically shifts to P (Park), and the Electronic Parking Brake (EPB) applies automatically.

However, if you need to stay in N (Neutral) with the vehicle off, refer to "To stay in N (Neutral) when vehicle is OFF" in the following page.



### CAUTION

**The vehicle can be started with the gear in N (Neutral), but for your safety, be sure to start the vehicle with the gear in P (Park).**

### To stay in N (Neutral) when vehicle is OFF

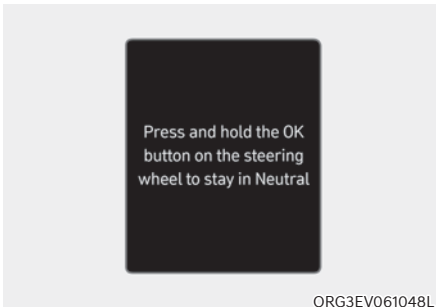

If you want to stay in N (Neutral) after the vehicle is OFF, do the following.

1. Turn off Auto Hold and release Electronic Parking Brake when the vehicle is in the ready (READY) mode.
2. Rotate the shift dial to N (neutral) while depressing the brake pedal.
3. When you take your foot off the brake pedal, the message 'Press and hold the OK Button on the steering Wheel to stay in Neutral' will appear on the cluster LCD display.

4. Press and hold the OK button on the steering wheel for more than 1 second.
5. When the message 'Vehicle will stay in (N). Change gear to cancel' (or 'N will stay engaged when the vehicle is Off') will appear on the cluster LCD display, press the Start/Stop button while depressing the brake pedal.

However, if you open the driver's door, the gear will automatically shift to P (Park) and the Start/Stop button will change to the OFF position.

### NOTICE

- **With the gear in N (Neutral) the Start/Stop button is in the ACC position. In the ACC position, the doors cannot be locked. The high voltage battery may discharge if left in the ACC position for a long time.**

### D (Drive)

This is the normal driving position. It automatically activates the regenerative braking system according to the road conditions.



To shift the gear to D (Drive), rotate the rotary gear shift dial to D (Drive) while depressing the brake pedal.

When the vehicle is stopped in the D (Drive) position, if you open the driver's door, the gear will automatically shift to P (Park).

However, if the vehicle is in motion, the gear may not automatically shift to P (Park) to prevent reduction gear damage.

### NOTICE

**Always come to a complete stop before shifting into D (Drive).**



### CAUTION

**When you start after stopping on a steep incline, even if the gear is in D (Drive), if you do not depress the accelerator or brake pedal, the vehicle may roll backwards, which can cause an accident.**

### When the battery is discharged

You cannot shift gears, when the battery is discharged.

In emergencies, do the following to shift the gear to N (Neutral) on a level ground.

1. Connect the battery cables from another vehicle or from a another battery to the jump-starting terminals inside the vehicle compartment.

For more details, refer to "Jump Starting" section in chapter 8.

2. Release the Electronic Parking Brake with the Start/Stop button in the ON position and the gear in P (Park).



3. Remove the cap-cover (1) and press the button (2) while depressing the brake pedal.

Then, the gear will change to the N (Neutral) position. The button must be pressed within 3 minutes after the READY indicator is off. The button (2) operates only for 20 seconds to change the gear between P (Park) and N (Neutral) from the time when the button (2) is first pressed.

### Shift-lock system

For your safety, your vehicle has a shiftlock system which prevents shifting the gear from P (Park) or N (Neutral) into R (Reverse) or D (Drive) unless the brake pedal is depressed.

To shift from P (Park) or N (Neutral) into R (Reverse) or D (Drive), from R (Reverse) into D (Drive) or from D (Drive) into R (Reverse) :

1. Depress and hold the brake pedal.
2. Start the vehicle.
3. Rotary the dial to the R (Reverse) or D (Drive).

### Information

**For your safety, you cannot shift the gear while the charging cable is connected.**

### Parking

Always come to a complete stop and continue to depress the brake pedal. Shift the gear to P (Park), apply the parking brake, and press the Start/Stop button to the OFF position. Take the Key with you when leaving the vehicle.

### LCD display messages (cluster)

#### *Press brake pedal to change gear*

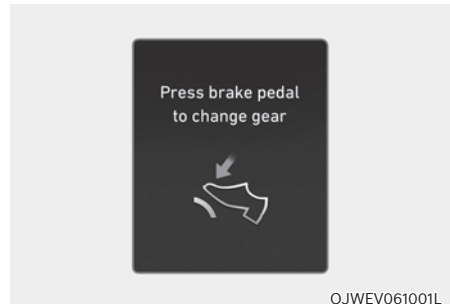

This message is displayed when the brake pedal is not depressed while shifting the gear.

Depress the brake pedal and then shift the gear.

#### *Shift to P after stopping*

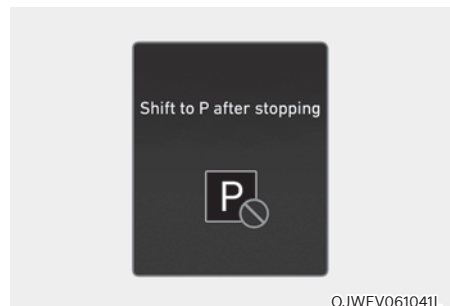

This message is displayed when the gear is shifted to P (Park) while the vehicle is moving.

Stop the vehicle before shifting to P (Park).

**Shifter system malfunction/Shifting system error**

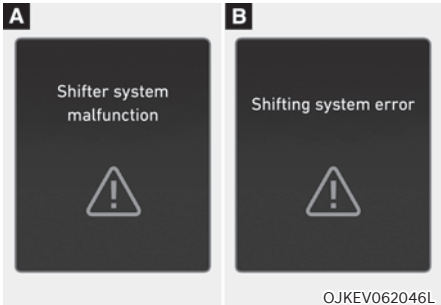

This message is displayed when the shift gear does not properly operate in the P (Park) position.

We recommend that you have the vehicle inspected by an authorized retailer of Genesis Branded products.

**Check shifter dial/Check rotary gear shift dial**

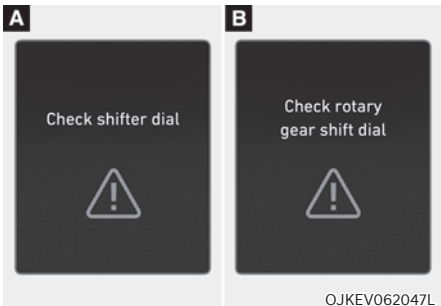

This message is displayed when there is a malfunction with the rotary gear shift dial.

We recommend that you have the vehicle inspected by an authorized retailer of Genesis Branded products.

**Check P button**



This message is displayed when there is a problem with the P button.

We recommend that you have the vehicle inspected by an authorized retailer of Genesis Branded products.

**Rotary shifter stuck/Rotary gear shift dial stuck**

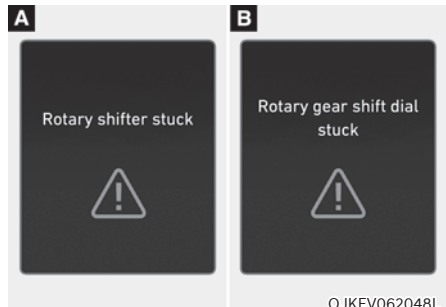

This message is displayed when the rotary gear shift dial does not return back to its normal position after rotating it.

We recommend that you have the vehicle inspected by an authorized retailer of Genesis Branded products.



## Good driving practices

- Never shift the gear from P (Park) or N (Neutral) to any other position with the accelerator pedal depressed.
- Never shift the gear into P (Park) when the vehicle is in motion.

Be sure the vehicle is completely stopped before you attempt to shift into R (Reverse) or D (Drive).

- Do not shift the gear to N (Neutral) when driving. If the gear is shifted to N (Neutral) while driving. Doing so may increase the risk of an accident.

Also, shifting the gear back to D (Drive) while the vehicle is moving may severely damage the reduction gear.

- When driving uphill or downhill, always shift to D (Drive) for driving forward or shift to R (Reverse) for driving rearwards. After selecting D (Drive) or R (Reverse), check the gear position indicated on the cluster before driving. If the vehicle moves in the opposite direction of the selected gear, the vehicle may turn off and a serious accident might occur due to degraded brake performance.
- Do not drive with your foot resting on the brake pedal. Even light, but consistent pedal pressure can result in the brakes overheating, brake wear and possibly even brake failure.
- Always apply the parking brake when leaving the vehicle. Do not depend on placing the shift gear in P (Park) to keep the vehicle from moving.

- Exercise extreme caution when driving on a slippery surface. Be especially careful when braking, accelerating or shifting gears. On a slippery surface, an abrupt change in vehicle speed can cause the drive wheels to lose traction and may cause loss of vehicle control resulting in an accident.
- Optimum vehicle performance and economy is obtained by smoothly depressing and releasing the accelerator.



## WARNING

To reduce the risk of **SERIOUS INJURY** or **DEATH**:

- **ALWAYS wear your seat belt. In a collision, an unbelted occupant is significantly more likely to be seriously injured or killed than a properly belted occupant.**
- **Avoid high speeds when cornering or turning.**
- **Do not make quick steering wheel movements, such as sharp lane changes or fast, sharp turns.**
- **The risk of rollover is greatly increased if you lose control of your vehicle at highway speeds.**
- **Loss of control often occurs if two or more wheels drop off the roadway and the driver over steers to reenter the roadway.**
- **In the event your vehicle leaves the roadway, do not steer sharply. Instead, slow down before pulling back into the travel lanes.**
- **Genesis Branded Vehicle recommends you to follow all posted speed limits.**

## REGENERATIVE BRAKING SYSTEM (PADDLE SHIFTER)

Regenerative braking system operates the paddle shift lever to control the regenerative braking intensity of the vehicle. It improves the fuel efficiency of the vehicle and helps the driver to have a better driving experience.

### Information

The regenerative braking system uses the electric motor to engage the brake. The electric motor converts the kinetic energy generated from decelerating the vehicle to electricity and charges the high voltage battery.

### Using regenerative braking system

#### Operating paddle shift lever

Operate the paddle shift lever as shown below to use the regenerative braking system.

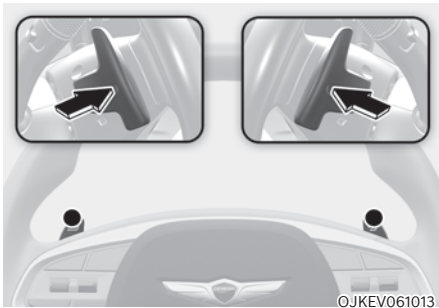

- Pull the left paddle shift (+/-) once to raise the regenerative braking intensity level by 1. It will increase decelerating intensity.
- Pull the right paddle shift (-/+) once to lower the regenerative braking intensity level by 1. It will decrease decelerating intensity.

- Pull and hold the left paddle shift (+/-) for over 0.5 seconds to keep raising the regenerative braking intensity level. Keeping hold of the paddle shift will bring the vehicle to stop.
- (While the smart recuperation system is turned on) Pull and hold the right paddle (-/+) shift for over 1 second to turn off the smart recuperation system. (See 'Smart Recuperation System' for the details.)

### Checking the amount of regenerative braking



The selected regenerative braking level is displayed on the instrument cluster. When the vehicle is turned off and on again after the regenerative braking level is lowered to 0 or i-PEDAL, the braking level will change to 1.

## Regenerative braking system limitations

Regenerative braking intensity cannot be changed using the paddle shift lever in the following situations:

- When the [ $+D$ ] and [ $-D$ ] paddle shift levers are pulled at the same time.
- When the vehicle is decelerating by depressing the brake pedal.
- When Smart Cruise Control is activated.
- When regenerative braking is continuously operated with the battery fully charged
- When the TERRAIN mode is activated
- When Downhill Brake Control (DBC) is activated

Initial setting of the regenerative braking level and adjustable range vary according to the selected Drive mode.

Drive mode	Adjustable Range
TERRAIN	0 to 1
ECO	0 to 3
COMFORT	0 to 3
SPORT	0 to 3

For more details, refer to "Drive Mode Integrated Control System" in this chapter.

## One Pedal Driving

One pedal driving operates the paddle shift lever while coasting to control the intensity of regenerative braking. It assists the driver to stop the vehicle without depressing the brake.

### Information

**Coasting is the process of driving a vehicle without the brake pedal and the accelerator depressed. Coasting uses the inertia of driving energy instead of the vehicle power.**

### *Using one pedal driving*

Pull and hold the left paddle shift lever ( $+D$ ) for over 0.5 seconds while coasting to enable the one pedal driving mode.

- Release the paddle shift lever when the vehicle speed is above 3km/h to return to the previously set regenerative braking level.
- If the vehicle speed is below 3km/h, the vehicle will keep engaging the brake although the driver releases the paddle shift lever.
- Releasing the paddle shift lever after the vehicle comes to a stop will maintain the vehicle stationary.



## CAUTION

- **The vehicle may not come to a stop although the one pedal driving function is active, depending on the condition of the vehicle and the road. Check the surroundings and depress the brake pedal to decelerate.**
- **If the driver depresses the accelerator while pulling and holding the left paddle shift lever () to increase the braking level, one pedal driving function will work like i-PEDAL function. In this case, the vehicle speed is no longer controllable through the paddle shift lever.**

### ***One pedal driving limitations***

In the following conditions, the vehicle may not come to a stop although the one pedal driving function is active. Depress the brake pedal to stop the vehicle.

- When driving on a slope, or when the vehicle is repeatedly driven and stopped
- When the vehicle is driving through the end of the slope
- When driving on a slippery surface such as an icy, rainy, or muddy road
- When the wheels are not properly aligned
- When a wheel slip or wheel spin occurs
- When the weight on board is too heavy
- When the vehicle is tilted to one side
- When the tire is worn out too much

### ***Automatic engagement of EPB***

Use one pedal driving function to bring the vehicle to a stop and automatically engage the electronic parking brake (EPB).



After the vehicle is stopped, EPB is automatically engaged when any of the following conditions are satisfied

- The driver's seatbelt is unfastened and the driver's door is open.
- The gear shifts to N (Neutral).
- The hood is open.
- The tailgate is open.
- 5 minutes have passed after the vehicle has stopped.
- One pedal driving is limited due to other reasons.

## Using i-PEDAL

i-PEDAL assists the driver to accelerate, decelerate, and stop the vehicle with only the accelerator pedal.

### Turning on/off the i-PEDAL

- Turning on i-PEDAL:  
Pull the left paddle shift lever () once when the regenerative braking level is at 3. i-PEDAL is turned on and the instrument cluster displays the 'i-PEDAL' message. i-PEDAL is not available while the smart recuperation system is ON. Turn off the smart recuperation system first before using i-PEDAL.
- Turning off i-PEDAL:  
Pull the right paddle shift lever () once while the function is ON. Otherwise, shift the gear to R (reverse) then to D (drive) while the function is ON. i-PEDAL is disabled and regenerative braking level is set to 3.



## CAUTION

- **Depending on the vehicle and road condition, the vehicle may not come to a stop although the i-PEDAL function is active. Check for the surroundings and depress the brake pedal to control the vehicle speed.**
- **Do not use i-PEDAL on slippery roads.**

### *i-PEDAL limitations*

In the following conditions, the vehicle may not come to a stop although the i-PEDAL is properly activated. Depress the brake to stop the vehicle.

- When driving on a slope, or when the vehicle is repeatedly driven and stopped
- When the vehicle is driving through the end of the slope
- When driving on a slippery surface such as an icy, rainy, or muddy road
- When the wheels are not properly aligned
- When a wheel slip or wheel spin occurs
- When the weight on board is too heavy
- When the vehicle is tilted to the side
- When the tire is worn out too much

## SMART RECUPERATION SYSTEM

The smart recuperation system recognizes vehicle-to-vehicle distance, road gradient, and speed cameras and controls the regenerative braking level while coasting. It reduces unnecessary depressing of pedals to improve fuel efficiency and driver convenience.

### **i** Information

- **Coasting is the process of driving a vehicle without the brake pedal and the accelerator depressed. Coasting uses the inertia of driving energy instead of the vehicle power.**
- **The regenerative braking system uses the electric motor to engage the brake. The electric motor converts the kinetic energy generated from decelerating the vehicle to electricity and charges the high voltage battery.**

### Smart recuperation system on/off

Operate the paddle shift lever as shown below to use the smart recuperation system.

- Turning on the smart recuperation system: While the READY indicator is ON, shift the gear to D (drive), and pull and hold the right paddle shift lever (➔) for over a second.

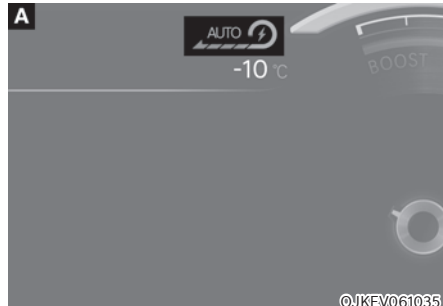

The smart recuperation system is ON and the regenerative braking level is displayed as AUTO.

- Turning off the smart recuperation system: While the smart recuperation system is ON, pull and hold the right paddle shift lever (➔) for over a second

The instrument cluster will display the regenerative braking level instead of 'AUTO', and the smart recuperation system will turn off.

- Using one pedal driving: While the smart recuperation system is ON, pull and hold the left paddle shift lever (➜) for over 0.5 seconds (See 'One Pedal Driving' for details)

i-PEDAL is not available while the smart recuperation system is ON. Turn off the smart recuperation system first before using i-PEDAL.

## Smart recuperation system operating condition

When the regenerative braking level is displayed as AUTO and the vehicle speed is above 10 km/h, the system will automatically control the regenerative braking level under the following conditions.

- The road gradient changes
- Distance from the vehicle ahead reduces or increases
- Speed of the vehicle ahead reduces or increases



### CAUTION

- When the forward safety warning light is ON, the smart recuperation system does not work properly. Depress the brake pedal for deceleration.
- The function that adjusts the regenerative braking intensity depending on the road gradient is only effective when the regenerative braking level is 0. Braking intensity does not significantly change depending on the road gradient if the regenerative braking level is 1 or above.

## Smart recuperation level settings

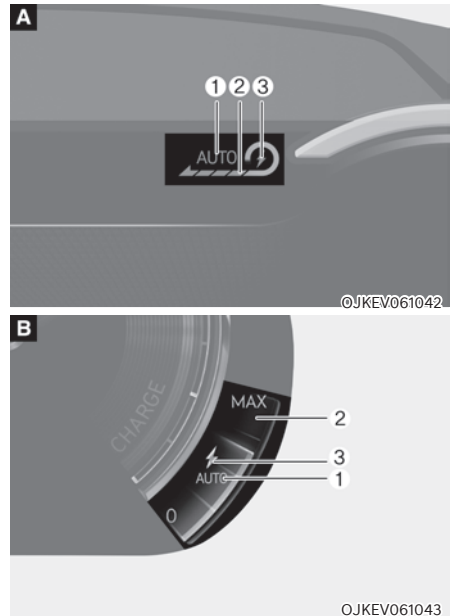

The instrument cluster displays 'AUTO' (1) when the smart recuperation system is ON. Depending on the conditions, the system adjusts the regenerative braking level (2). The sky blue indicator light (3) illuminates when the vehicle recognizes a vehicle.

### Smart recuperation default setting

The default braking level of the smart recuperation system can be changed. Set the default braking level to the lowest and let the system adjust the braking intensity automatically.

To change the default level of the smart recuperation system, pull the right paddle shift lever (➔) once while the system is ON.

### Smart recuperation intensity setting

Regenerative braking intensity of the smart recuperation system can be adjusted to match the driver's preference. Adjust the braking intensity makes the decelerating faster or slower.

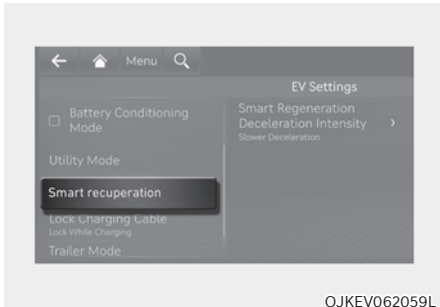

To adjust the regenerative braking level of the smart recuperation system, go to Settings → EV → Smart recuperation from the infotainment system.

### Pausing smart recuperation system

The smart recuperation system is temporarily turned off in the following conditions. While the system is turned off, the driver must keep eyes on the surroundings and depress the brake pedal to decelerate.

- The gear is shifted to N (Neutral), R (Reverse) or P (Park)
- Smart Cruise Control is ON
- ESC (Electronic Stability Control) is operating
- ABS is operating

### Front sensors (Front radar)



[A]: Front radar

Front sensors recognize the distance from the vehicle ahead to control the regenerative braking intensity. If the sensor is covered with snow, rain, or other foreign substances, the performance of the sensors may deteriorate, and the smart recuperation system may turn off. Always keep the sensors clean.



## System warning due to sensor problems

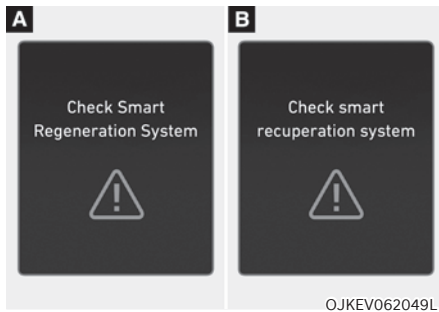

If the smart recuperation system is turned off due to the front sensors being covered with the foreign substances or due to other causes, the above warning message is displayed. Also the regenerative braking level is displayed instead of 'AUTO'.

Remove foreign substances from the sensors and turn on the system again by pulling and holding the right paddle shift lever for over a second.

If the warning message is still displayed after the sensors are cleaned, visit an authorized retailer of Genesis Branded products for inspection.

## Precautions for smart recuperation system

The smart recuperation system is only for the driver's convenience and not a safety feature. The smart recuperation system neither completely engages the brake nor automatically avoids collisions. The driver must safely drive and operate the vehicle with his/her own decision although the system is turned on.

The smart recuperation system may not work properly if the system has difficulties recognizing the road condition due to the road condition due to congested traffic or deformed road shape. Always keep the safety distance while driving, and depress the brake pedal for deceleration.

Keep the following instructions for safe and efficient use of the smart recuperation system.

### **General precautions**

- Always keep the safety distance from the vehicle ahead, and secure braking distance.
- Always prepare for unexpected situations and depress the brake pedal to decelerate when necessary. The smart recuperation system cannot react to pedestrians, vehicles making a sudden stop and vehicles coming from the opposite lane.
- If the vehicle ahead frequently changes the lane, keep your eyes forward to be prepared for hazardous situations. In this case, the smart recuperation system may respond late and may inappropriately respond to vehicle movements from the side lanes.
- The driver must depress the brake pedal when stopping the vehicle.
- Depress the brake pedal to decelerate in the following conditions.
  - When the front part of the vehicle is lifted up because of the cargo loaded on the rear part of the vehicle.
  - When the driver is operating the steering wheel.
  - When the vehicle is not driving in the center of the lane.
  - When the vehicle is driving on a that is too narrow or too curved.
- The smart recuperation system may be temporarily turn off when exposed to strong electromagnetic waves.
- If the vehicle starts coasting near the speed camera and engages the brake with the smart recuperation system, the vehicle may not be able to keep the speed limit. Always comply with the road and traffic law.

### **Precautions for front sensors**

- Make sure that no physical impact is applied to the sensor or its surroundings. If the sensor is dislocated due to the shock, the system may not work properly and the instrument cluster may not display any warnings. If the sensor is exposed to physical impacts, visit an authorized retailer of Genesis Branded products for inspection.
- The sensors and its surroundings, the sensor covers, and the vehicle grille should always be kept clean.
- Do not attach any accessories such as molding or stickers on the sensor and its detection range, or change the vehicle grille. It may affect sensor performance.
- Always use genuine parts for the sensor cover, and do not paint it.
- Use soft fabric to prevent damage to the sensor cover when washing the car.
- Do not directly spray the sensor behind the grille with high pressured water when washing the car.

### Precautions for vehicle recognition

- The front sensors may suddenly recognize the foregoing vehicle when the smart recuperation system reacts slowly, or the vehicle is going through the end of a slope or curve. In this case, the regenerative braking intensity is increased and the vehicle may slow down.

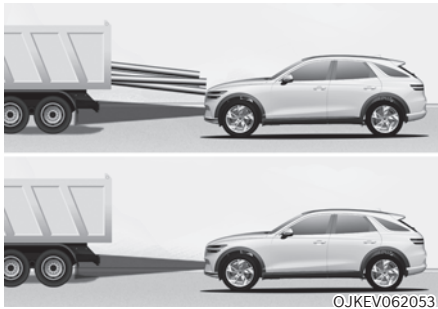

- The front sensors may be unable to recognize the vehicle ahead in the following situations even if it is on the same lane.
  - Narrow vehicles such as motorcycles or bicycles
  - Vehicles offset to one side
  - Slow-moving vehicles or sudden decelerating vehicles
  - Vehicles with small rear profile such as trailers with no loads
- When the vehicle in front of the foregoing vehicle is at a stop and the foregoing vehicle changes the lane, the front sensors may be unable to recognize the stopped vehicle.

### Precautions on the curves

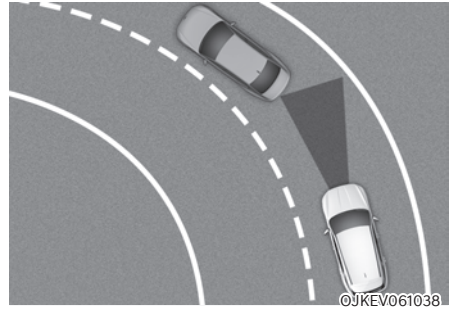

The front sensors may be unable to recognize the foregoing vehicle if you are coasting on a curve. The regenerative braking intensity may automatically be lowered, which may accelerate the vehicle.



- On a curved road, the front sensors may recognize the vehicles on the other lane as the foregoing vehicle of the same lane. It may increase the regenerative braking intensity and the vehicle may decelerate. Check the surroundings and depress the accelerator to prevent unnecessary reduce of speed.
- If the front sensors suddenly recognize the vehicle ahead, regenerative braking intensity may rise and the vehicle may decelerate.

**Precautions on the slope**

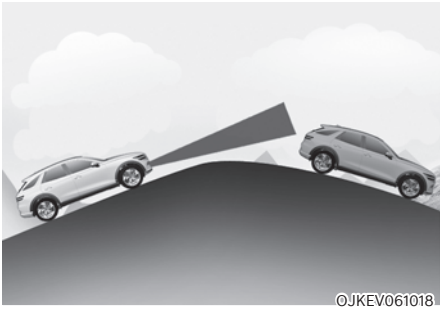

- When the vehicle is coasting through the end of a slope or where the gradient is changing, the front sensors may be unable to recognize, or may suddenly recognize the vehicle ahead. It may adjust the regenerative braking intensity and change the vehicle speed.
- When driving up or down the slope, check for the surroundings and depress the brake pedal to decelerate.

**Precautions for shifting lanes**

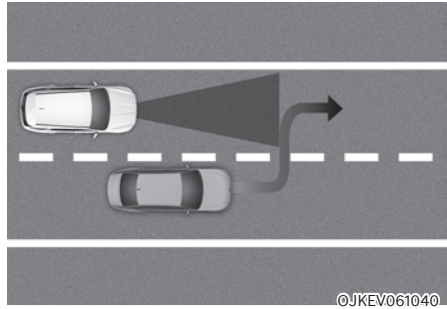

- If a vehicle on the next lane is moving into the front of your vehicle, the front sensors can only recognize the vehicle when it is completely inside the detection range.
- The front sensors may recognize the vehicles late that intervene suddenly.

## BRAKING SYSTEM

### Power-assist brakes

Your vehicle has power-assisted brakes that adjust automatically through normal usage.

In the event of a vehicle power failure, the power assist for the brakes will not work. You can still stop your vehicle, but it will require greater force and increased pedal travel than normal. The stopping distance, however, will be longer than with power brakes.

### Information

- When the brake pedal is depressed under certain driving conditions or weather conditions, you may temporarily hear a noise. This is normal and does not indicate a problem with your brakes.
- While driving on a road with deicing chemicals, brake noise or abnormal tire wear may occur due to deicing chemicals. In a safe traffic condition, additionally apply the brakes to remove deicing chemicals on the brake discs and pads.

### WARNING

Take the following precautions:

- Do not drive with your foot resting on the brake pedal. This will create abnormal high brake temperatures, excessive brake lining and pad wear, and increased stopping distances. So increase the regeneration braking level with the left paddle shift lever to decrease the speed.

- When descending down a long or steep hill, use the paddle shifter to increase the regeneration braking level in order to decrease your speed without using the brake pedal excessively. Applying the brakes continuously will cause the brakes to overheat and could result in a temporary loss of braking performance.
- Wet brakes may impair the vehicle's ability to safely slow down; the vehicle may also pull to one side when the brakes are applied. Applying the brakes lightly will indicate whether they have been affected in this way. Always test your brakes in this fashion after driving through deep water. To dry the brakes, lightly tap the brake pedal to heat up the brakes while maintaining a safe forward speed until brake performance returns to normal. Avoid driving at high speeds until the brakes function correctly.

### NOTICE

- Do not continue depressing the brake pedal if the (READY) indicator is OFF. The battery may be discharged.
- Noise and vibration generated during braking is normal.
- Under normal operation, electric brake pump noise and motor vibration may occur temporarily in below cases.
  - When the pedal is depressed suddenly.
  - When the pedal is repeatedly depressed in short intervals.
  - When the ABS function is activated while braking.

### Disc brakes wear indicator

When your brake pads are worn and new pads are required, you will hear a high pitched warning sound from your front or rear brakes. You may hear this sound come and go or it may occur whenever you depress the brake pedal.

#### **NOTICE**

**To avoid costly brake repairs, do not continue to drive with worn brake pads.**

#### **Information**

Always replace brake pads as complete front or rear axle sets.

### High performance brake

For vehicles equipped with the High Performance Brake (large diameter monoblock brakes with enhanced braking performance), noise such as a squeal, squeak or groan is generated while braking. This is normal and the friction may create circle patterns on the disc surface. This is also a normal condition which does not affect braking performance.

#### **WARNING**

**Frequent braking may deform components and worn the disc brake causing vibration when braking. Observe the speed limit to prevent brake damage from excessive braking.**

**Brake wear, noise, vibration from excessive braking or deformation of the brakes caused by repeatedly braking in high speed, racing on tracks, etc., can be excluded from warranty coverage.**

## Electronic Parking Brake (EPB) Applying the parking brake

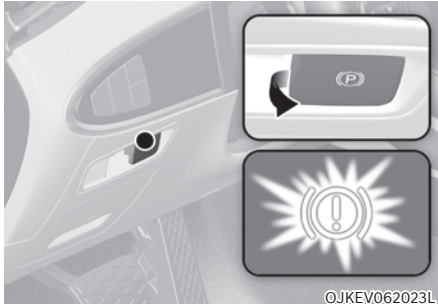

### To apply EPB (Electronic Parking Brake):

1. Depress and hold the brake pedal.
2. Pull up the EPB switch.

Make sure the Parking Brake warning light comes on.

**EPB (Electronic Parking Brake) may be automatically applied when:**

- Requested by other systems
- The driver turns the vehicle off while Auto Hold is operating.

### Emergency braking

If there is a problem with the brake pedal while driving, emergency braking is possible by pulling up and holding the EPB switch. Braking is possible only while you are holding the EPB switch. However, braking distance will be longer than normal.

### **WARNING**

To reduce the risk of **SERIOUS INJURY** or **DEATH**, do not operate the EPB while the vehicle is moving except in an emergency situation. It could damage the brake system and lead to an accident.

### **Information**

During emergency braking, the Parking Brake warning light will illuminate to indicate that the system is operating.

### **NOTICE**

If you continuously notice a noise or burning smell when the EPB is used for emergency braking, we recommend that you have the system checked by an authorized retailer of Genesis Branded products.

### Releasing the parking brake

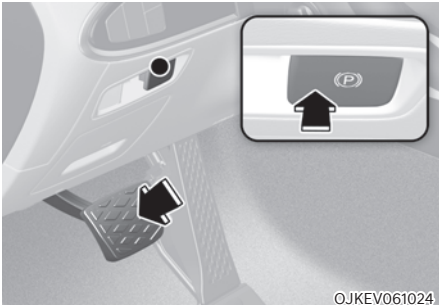

#### To release EPB (Electronic Parking Brake):

1. Press the Start/Stop button to the ON or START position.
2. Press the EPB switch while depressing the brake pedal.

Make sure the Parking Brake warning light goes off.

#### To release EPB (Electronic Parking Brake) automatically:

- Gear in P (Park)  
With the vehicle in the ready (READY) mode, depress the brake pedal and shift out of P (Park) to R (Reverse) or D (Drive).
- Gear in N (Neutral)  
With the vehicle in the ready (READY) mode, depress the brake pedal and shift out of N (Neutral) to R (Reverse) or D (Drive).

- Satisfy the following conditions
  1. Ensure seat belts are fastened and the doors, hood and tailgate are closed.
  2. With the vehicle in the ready (READY) mode, depress the brake pedal and shift out of P (Park) to R (Reverse), D (Drive).
  3. Depress the accelerator pedal.  
Make sure the Parking Brake warning light goes off.

### **i** Information

- **For the Middle East, EPB is released regardless of seat belt fastening.**
- **For your safety, you can engage EPB even though the Vehicle Stop/Start button is in the OFF position (only if battery power is available), but you cannot release it.**
- **For your safety, depress the brake pedal and release the parking brake manually with the EPB switch when you drive downhill or when backing up the vehicle.**

### **NOTICE**

- **If the Parking Brake warning light is still on even though the EPB has been released, we recommend that you have the system checked by an authorized retailer of Genesis Branded products.**
- **Do not drive your vehicle with EPB applied. It may cause excessive brake pad and brake rotor wear.**



## Warning messages

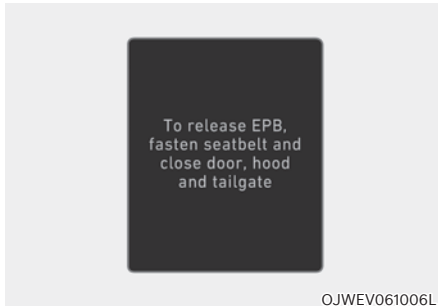

### To release EPB, fasten seatbelt and close door, hood and tailgate

- If you try to drive with EPB applied, a warning will sound and a message will appear.
- If the driver's seat belt is unfastened and the hood or tailgate is opened, a warning will sound and a message will appear.
- If there is a problem with the vehicle, a warning may sound and a message may appear.

If the situation occurs, depress the brake pedal and release EPB by pressing the EPB switch.



## WARNING

- **Whenever leaving the vehicle or parking, always come to a complete stop and continue to depress the brake pedal.**

**Shift the gear into P (Park), pull the EPB switch, and press the Start/Stop button to the OFF position. Take the Key with you when leaving the vehicle.**

**Vehicles not fully engaged in P (Park) with the parking brake set are at risk for moving inadvertently and causing injury to yourself or others.**

- **NEVER allow anyone who is unfamiliar with the vehicle to touch the EPB switch. If EPB is released unintentionally, serious injury may occur.**
- **Only release EPB when you are seated inside the vehicle with your foot firmly on the brake pedal.**



## CAUTION

**In winter, the Electronic Parking Brake (EPB) related device may freeze and cannot be released. Do not use the Electronic Parking Brake (EPB) but park on a flat surface with the gear in P (Park). Use wheel chocks under the wheels if necessary.**

**If the Electronic Parking Brake (EPB) applies automatically when the gear is shifted to P (Park), turn off Auto Hold, and press the Electronic Parking Brake (EPB) switch to release the parking brake.**

## NOTICE

- **Do not apply the accelerator pedal while the parking brake is engaged. If you depress the accelerator pedal with EPB engaged, a warning will sound and a message will appear. Damage to the parking brake may occur.**
- **Driving with the parking brake on can overheat the braking system and cause premature wear or damage to brake parts. Make sure EPB is released and the Parking Brake warning light is off before driving.**

**i** Information

- A clicking sound may be heard while operating or releasing the EPB. These conditions are normal and indicate that EPB is functioning properly.
- When leaving your keys with a parking attendant or assistant, make sure to inform him/her how to operate EPB.

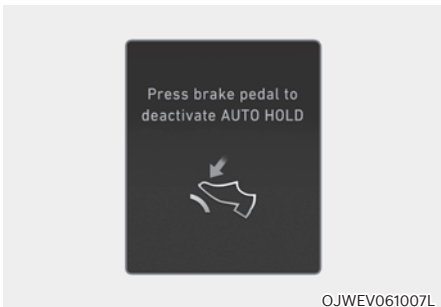

**AUTO HOLD turning Off! Press brake pedal**

When the conversion from Auto Hold to EPB is not working properly a warning will sound and a message will appear.

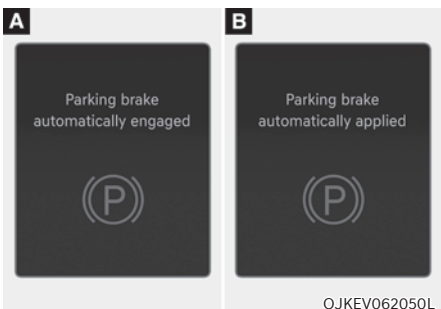

**Parking brake automatically engaged/  
Parking brake automatically applied**

When EPB is applied while Auto Hold is activated, a warning will sound and a message will appear.

**EPB malfunction**

Electronic Parking Brake (EPB) warning light illuminates if the Start/Stop button is pressed to the ON position and goes off in approximately 3 seconds if the system is operating normally.

If the EPB warning light remains on, comes on while driving, or does not come on when the Start/Stop button is pressed to the ON position, this indicates that the EPB may have malfunctioned.

If this occurs, we recommend that you have the system checked by an authorized retailer of Genesis Branded products.

The EPB warning light may illuminate when the ESC indicator comes on to indicate that ESC is not working properly, but it does not indicate a malfunction of EPB.

**NOTICE**

- If the EPB warning light is still on, we recommend that you have the system checked by an authorized retailer of Genesis Branded products.
- If the Parking Brake warning light does not illuminate or blinks even though the EPB switch was pulled up, EPB may not be applied.
- If the Parking Brake warning light blinks when the EPB warning light is on, press the switch, and then pull it up. Repeat this one more time. If the EPB warning does not go off, we recommend that you have the system checked by an authorized retailer of Genesis Branded products.

### ***Parking brake warning light***

 Check the Parking Brake warning light by pressing the Vehicle Stop/Start button to the ON position.

This light will be illuminated when the parking brake is applied with the Vehicle Stop/Start button in the START or ON position.

Before driving, be sure the parking brake is released and the Parking Brake warning light is OFF.

If the Parking Brake warning light remains on after the parking brake is released while the motor is running, there may be a malfunction in the brake system. Immediate attention is necessary.

If at all possible, cease driving the vehicle immediately. If that is not possible, use extreme caution while operating the vehicle and only continue to drive the vehicle until you can reach a safe location.

### ***When the EPB (Electronic Parking Brake) does not release***

If the EPB does not release normally, we recommend that you contact an authorized retailer of Genesis Branded products by loading the vehicle on a flatbed tow truck and have the system checked.

### **Auto Hold**

Auto Hold maintains the vehicle in a standstill even though the brake pedal is not depressed after the driver brings the vehicle to a complete stop by depressing the brake pedal.

#### **Information**

**The Auto Hold On or Off setting is maintained when the vehicle is turned off. When the vehicle is restarted the last setting for Auto Hold is applied.**

#### ***To apply:***



1. With the driver's door and hood closed, depress the brake pedal and then press the AUTO HOLD switch. The white AUTO HOLD indicator will come on and the system will be in the standby position.

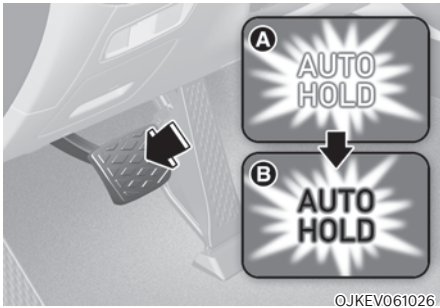

[A]: White, [B]: Green

2. When you stop the vehicle completely by depressing the brake pedal, Auto Hold maintains the brake pressure to hold the vehicle stationary. The indicator changes from white to green.
3. The vehicle will remain stationary even if you release the brake pedal.
4. If EPB is applied, Auto Hold will be released.

**To release:**

If you depress the accelerator pedal with the gear in D (Drive), R (Reverse) or Manual shift mode, the Auto Hold will be released automatically and the vehicle will start to move. The AUTO HOLD indicator changes from green to white.

**⚠ WARNING**

**When Auto Hold is automatically released by depressing the accelerator pedal, always take a look around your vehicle.**

**Slowly depress the accelerator pedal for a smooth start.**

**To cancel:**



[A]: OFF

1. Depress and hold the brake pedal.
  2. Press the AUTO HOLD switch.
- The AUTO HOLD indicator will turn off.

**⚠ WARNING**

**To prevent, unexpected and sudden vehicle movement, ALWAYS press your foot on the brake pedal to cancel the Auto Hold before you:**

- Drive downhill.
- Drive the vehicle in R (Reverse).
- Park the vehicle.

### **i** Information

- The Auto Hold does not operate when:
  - The gear is in P (Park)
  - EPB is applied
- For your safety, the Auto Hold automatically switches to EPB when:
  - The driver's door is opened
  - The tailgate is opened
  - The hood is opened
  - The vehicle is in a standstill for more than 10 minutes
  - The vehicle is standing on a steep slope
  - The vehicle moved several times

In these cases, the Parking Brake warning light comes on, the AUTO HOLD indicator changes from green to white, and a warning sound and a message will appear to inform you that EPB has been automatically engaged. Before driving off again, depress the brake pedal, check the surrounding area near your vehicle and release the parking brake manually with the EPB switch.

- While operating Auto Hold, you may hear mechanical noise. However, it is normal operating noise.
- If the vehicle is restarted with the Auto Hold system in the standby position or operating, the Auto hold system will continue to operate in the standby position.

### **NOTICE**

If the AUTO HOLD indicator changes to yellow, Auto Hold is not working properly. We recommend that you contact an authorized retailer of Genesis Branded products.

### **WARNING**

- Depress the accelerator pedal slowly when you start the vehicle.
- For your safety, cancel Auto Hold when you drive downhill, back up the vehicle or park the vehicle.

### **NOTICE**

If there is a malfunction with the driver's door or hood open detection system, Auto Hold may not work properly.

We recommend that you contact an authorized retailer of Genesis Branded products.

### *Warning messages*

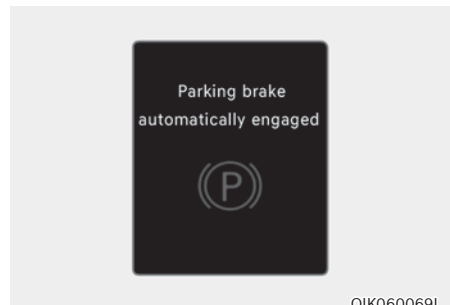

#### **Parking brake automatically engaged**

When EPB is applied while Auto Hold is activated, a warning will sound and a message will appear.

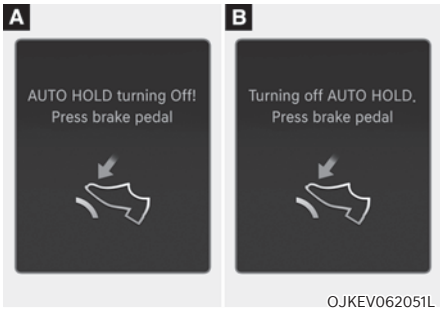

**AUTO HOLD turning Off! Press brake pedal/Turning off AUTO HOLD. Press brake pedal**

When the conversion from Auto Hold to EPB is not working properly a warning will sound and a message will appear. When this message is displayed, Auto Hold and EPB may not operate. For your safety, depress the brake pedal.

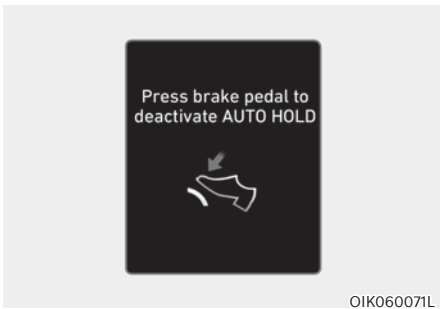

**Press brake pedal to deactivate AUTO HOLD**

If you did not apply the brake pedal when you release Auto Hold by pressing the AUTO HOLD switch, a warning will sound and a message will appear.

**Brake Disc Cleaning**

Use the Brake Disc Cleaning function if noise is generated when depressing the brake while driving or if the brake disc gets rusty. It helps reduce the noise and rust. Regenerative braking is restrained while Brake Disc Cleaning is operated, which may lower the electric energy efficiency.

Press and hold the AUTO HOLD button for over 3 seconds.

- Brake Disc Cleaning starts operating when the message 'Brake disc cleaning' is displayed on the instrument cluster.
- Regenerative braking is restrained while the brake is depressed approximately 10 times while driving (it may differ depending on driving conditions). It helps reduce the noise and rust.
- Brake Disc Cleaning function will turn off automatically when the operation is completed. It can also be turned off before operation is completed by turning off the vehicle or pressing the AUTO HOLD button for over 3 seconds.

## Anti-lock Brake System (ABS)



### WARNING

**Anti-Lock Braking System (ABS) or Electronic Stability Control (ESC) system will not prevent accidents due to improper or dangerous driving maneuvers. Even though vehicle control is improved during emergency braking, always maintain a safe distance between you and objects ahead of you. Vehicle speeds should always be reduced during extreme road conditions. The braking distance for vehicles equipped with ABS or ESC may be longer than for those without these systems in the following road conditions.**

**Drive your vehicle at reduced speeds during the following conditions:**

- **Rough, gravel or snow-covered roads.**
- **On roads where the road surface is pitted or has different surface height.**
- **Tire chains are installed on your vehicle.**

**The safety features of ABS or ESC equipped vehicle should not be tested by high speed driving or cornering. This could endanger the safety of yourself or others.**

ABS is an electronic braking system that helps prevent a braking skid. ABS allows the driver to steer and brake at the same time.

## Using ABS

To obtain the maximum benefit from your ABS in an emergency situation, do not attempt to modulate your brake pressure and do not try to pump your brakes.

When you apply your brakes under conditions which may lock the wheels, you may hear sounds from the brakes, or feel a corresponding sensation in the brake pedal. This is normal and it means your ABS is active.

ABS does not reduce the time or distance it takes to stop the vehicle.

Always maintain a safe distance from the vehicle in front of you.

ABS will not prevent a skid that results from sudden changes in direction, such as trying to take a corner too fast or making a sudden lane change. Always drive at a safe speed for the road and weather conditions.

ABS cannot prevent a loss of stability. Always steer moderately when braking hard. Severe or sharp steering wheel movement can still cause your vehicle to veer into oncoming traffic or off the road.

On loose or uneven road surfaces, operation of the anti-lock brake system may result in a longer stopping distance than for vehicles equipped with a conventional brake system.

The ABS ((ABS)) warning light will stay on for several seconds after the Start/Stop button is in the ON position.

During that time, ABS will go through self-diagnosis and the light will go off if everything is normal. If the light stays on, you may have a problem with your ABS. We recommend that you contact an authorized retailer of Genesis Branded products as soon as possible.



### WARNING

If the ABS ((ABS)) warning light is on and stays on, you may have a problem with the ABS. Your power brakes will work normally. To reduce the risk of serious injury or death, we recommend that you contact your authorized retailer of Genesis Branded products as soon as possible.

### NOTICE

When you drive on a road having poor traction, such as an icy road, and apply your brakes continuously, ABS will be active continuously and the ABS ((ABS)) warning light may illuminate. Pull your vehicle over to a safe place and turn the vehicle off.

Restart the vehicle. If the ABS warning light is off, then your ABS system is normal.

Otherwise, you may have a problem with your ABS system. We recommend that you contact an authorized retailer of Genesis Branded products as soon as possible.



### Information

When you jump start your vehicle because of a drained battery, the ABS ((ABS)) warning light may turn on at the same time. This happens because of the low battery voltage. It does not mean your ABS is malfunctioning. Have the battery recharged before driving the vehicle.

### Electronic Stability Control (ESC)

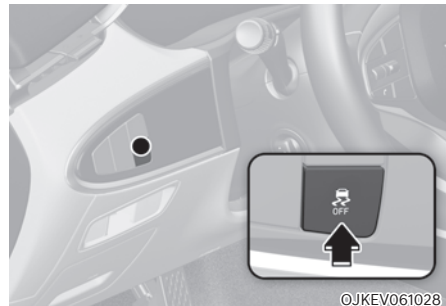

Electronic Stability Control helps to stabilize the vehicle during cornering maneuvers.

ESC checks where you are steering and where the vehicle is actually going. ESC applies braking pressure to any one of the vehicle's brakes and intervenes in the electric vehicle control system to assist the driver with keeping the vehicle on the intended path. It is not a substitute for safe driving practices. Always adjust your speed and driving to the road conditions.



**WARNING**

**Never drive too fast for the road conditions when cornering. ESC will not prevent accidents.**

**Excessive speed in turns, abrupt maneuvers, and hydroplaning on wet surfaces can result in severe accidents.**

**ESC operation****ESC ON condition**

When the Start/Stop button is in the ON position, ESC and the ESC OFF indicator lights illuminate for approximately three seconds. After both lights go off, ESC is enabled.

**When operating**

When ESC is in operation, the ESC indicator light blinks:

- When you apply your brakes under conditions which may lock the wheels, you may hear sounds from the brakes, or feel a corresponding sensation in the brake pedal. This is normal and it means your ESC is active.
- When ESC activates, the vehicle may not respond to the accelerator as it does under routine conditions.
- If Smart Cruise Control (SCC) was in use when ESC activates, Smart Cruise Control (SCC) automatically disengages. Smart Cruise Control (SCC) can be reengaged when the road conditions allow. **See “Smart Cruise Control (SCC)” section in chapter 7 (if equipped).**

**ESC OFF condition**

To cancel ESC operation:

- State 1

Press the ESC OFF button briefly. The ESC OFF indicator light and/or message 'Traction Control disabled' will illuminate. In this state, the traction control function of ESC is disabled, but the brake control function of ESC (braking management) still operates.

- State 2

Press and hold the ESC OFF button continuously for more than 3 seconds. The ESC OFF indicator light and/or message 'Traction & Stability Control disabled' illuminates and a warning chime sounds. In this state, both the traction control function of ESC and the brake control function of ESC (braking management) are disabled.

If the Start/Stop button is pressed to the OFF position when ESC is off, ESC remains off. Upon restarting the vehicle, ESC will automatically turn on again.

### Indicator lights

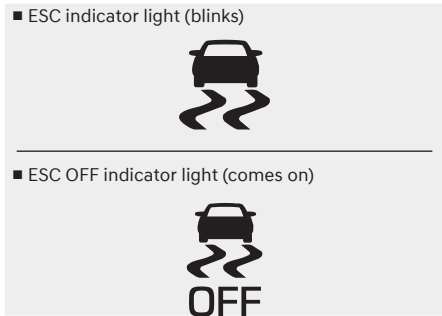

When the Start/Stop button is pressed to the ON position, the ESC indicator light illuminates, then goes off if the ESC system is operating normally.

The ESC indicator light blinks whenever ESC is operating.

If the ESC indicator light stays on, your vehicle may have a malfunction with the ESC system. When this warning light illuminates we recommend that the vehicle be checked by an authorized retailer of Genesis Branded products as soon as possible.

The ESC OFF indicator light comes on when ESC is turned off.



### WARNING

When ESC is blinking, this indicates ESC is active:

Drive slowly and NEVER attempt to accelerate. NEVER turn ESC off while the ESC indicator light is blinking or you may lose control of the vehicle resulting in an accident.

### NOTICE

Driving with wheels and tires with different sizes may cause the ESC system to malfunction. Before replacing tires, make sure all four tires and wheels are the same size. Never drive the vehicle with different sized wheels and tires installed.

### ESC OFF usage

#### When Driving

The ESC OFF mode should only be used briefly to help free the vehicle if stuck in snow or mud, by temporarily stopping operation of ESC, to maintain wheel torque.

To turn ESC off while driving, press the ESC OFF button while driving on a flat road surface.

### NOTICE

To prevent damage to the reduction gear:

- Do not allow wheel(s) of one axle to spin excessively while the ESC, ABS, and Parking Brake warning lights are displayed. The repairs would not be covered by the vehicle warranty. Reduce motor power and do not spin the wheel(s) excessively while these lights are displayed.
- When operating the vehicle on a dynamometer, make sure ESC is turned off (ESC OFF light illuminated).



### Information

Turning ESC off does not affect ABS or standard brake system operation.

## Vehicle Stability Management (VSM)

Vehicle Stability Management is a function of the Electronic Stability Control (ESC) system. It helps the vehicle stay stable when accelerating or braking suddenly on wet, slippery and rough roads where traction over the four tires can suddenly become uneven.



### WARNING

Take the following precautions when using Vehicle Stability Management:

- **ALWAYS** check the speed and the distance to the vehicle ahead. VSM is not a substitute for safe driving practices.
- **Never** drive too fast for the road conditions. VSM will not prevent accidents. Excessive speed in bad weather, on slippery and uneven roads can result in severe accidents.

## VSM operation

### When operating

When you apply your brakes under conditions which may activate ESC, you may hear sounds from the brakes, or feel a corresponding sensation in the brake pedal. This is normal and it means your VSM is active.



### Information

VSM does not operate when:

- Driving on a banked road such as gradient or incline.
- Driving in reverse.
- The ESC OFF indicator light is on.
- The MDPS (Motor Driven Power Steering) warning light (⚠) is on or blinks.

### VSM OFF condition

To cancel VSM operation, press the ESC OFF button. ESC OFF (OFF) indicator light will illuminate.

To turn on VSM, press the ESC OFF button again. The ESC OFF indicator light will go out.



### WARNING

If the ESC (OFF) indicator light or MDPS (OFF) warning light stays illuminated or blinks, your vehicle may have a malfunction with the VSM system. When the warning light illuminates we recommend that the vehicle be checked by an authorized retailer of Genesis Branded products as soon as possible.

### NOTICE

Driving with wheels and tires with different sizes may cause the VSM system to malfunction. Before replacing tires, make sure all four tires and wheels are the same size. Never drive the vehicle with different sized tires and wheels installed.

### Trailer Stability Assist (TSA)

Trailer stability assist is operated as a vehicle stability control system. The Trailer stability assist system stabilizes the vehicle and trailer when the trailer sways or oscillates. In most cases, trailer sway happens at high speeds.

Factors that can cause trailer sway include:

- High speed
- Strong crosswinds
- Improper overloading
- Sudden steering inputs
- Uneven road

When the Trailer stability assist system detects sway, the front brakes are applied automatically. If it is not enough braking, the brakes are applied on all wheels automatically and vehicle power is reduced.

## Hill-Start Assist Control (HAC)

Hill-Start Assist Control helps prevent the vehicle from rolling backwards when starting a vehicle from a stop on a hill. The system operates the brakes automatically for approximately 2 seconds (maximum of 5 seconds when the accelerator pedal is slightly depressed during HAC operation) and releases the brake after 2 seconds or when the accelerator pedal is depressed.



### WARNING

**Always be ready to depress the accelerator pedal when starting off an incline. Hill-Start Assist Control activates only for approximately 2 seconds (maximum of 5 seconds when the accelerator pedal is slightly depressed during HAC operation).**



### Information

- **Hill-Start Assist Control does not operate when the gear is shifted to P (Park) or N (Neutral).**
- **Hill-Start Assist Control activates even when the ESC (Electronic Stability Control) is off. However, it does not activate, when ESC does not operate normally.**

## Emergency Stop Signal (ESS)

Emergency Stop Signal alerts the driver behind by blinking the stop lights, while sharply and severely braking.

The system is activated when:

- The vehicle suddenly stops. (The deceleration power exceeds  $7 \text{ m/s}^2$ , and the driving speed exceeds 55 km/h (34 mph).)
- ABS is activated and the driving speed exceeds 55 km/h (34 mph).

The hazard warning flasher automatically turns ON after blinking the stop lights:

- When driving speed is under 40 km/h (25 mph),
- When ABS is deactivated, and
- When the sudden braking situation is over.

The hazard warning flasher turns OFF:

- When the vehicle drives at a low speed for a certain period of time.

The driver can manually turn OFF the hazard warning flasher by pressing the button.



### Information

**Emergency Stop Signal will not activate, when the hazard warning flashers are already on.**

## Multi-Collision Brake (MCB)

Multi-Collision Brake controls the brake automatically in the event of an accident where the air bag deploys to reduce the risk of additional accidents that may occur.

### System operation

- From the time the air bag deploys. Multi-Collision Brake monitors the depression intensity of the brake pedal and accelerator pedal for a short period. The system operates when the following conditions are met:
  - Vehicle speed is under 180 km/h (112 mph) at the time of collision.
  - The brake pedal and accelerator pedal is hardly depressed.
- When the driver steps on the brake pedal over a certain level while Multi-Collision Brake is active, the braking power takes priority over automatic braking by Multi-Collision Brake system. However, if the driver takes his/her foot off the brake pedal, automatic braking by Multi-Collision Brake system will maintain automatic braking.

### System off

Multi-Collision Brake is canceled in the following situations:

- The accelerator pedal is depressed over a certain level.
- The vehicle stops.
- ESC (Electronic Stability Control) or electronic devices has malfunctioned.
- In a situation system cannot operate normally.
- Ten seconds have passed since the brake has been controlled automatically by Multi-Collision Brake system.



### WARNING

- **Multi-Collision Brake decreases vehicle speed after a collision, but it does not prevent a second collision. You may drive away from the collision spot to avoid other dangerous situations by depressing the accelerator pedal.**
- **After the vehicle is stopped by Multi-Collision Brake, the system stops controlling the brakes. Depending on the situation, the driver should depress the brake or the accelerator pedal to prevent further accidents.**

## Brake Assistant System (BAS)

The Brake Assistant System provides additional pressure when the brake pedal is momentarily and strongly depressed in a situation sudden braking is required while driving.

The Brake Assistant System reduces the time for ABS(Anti-Lock Brake System) control to enter and consequently reduces the braking distance, by providing additional pressure up to the point of ABS intervention.

### ***BAS operation***

- When the vehicle speed is more than 30 km/h and the ABS control is not entered.
- When the brake pedal is depressed strongly over a certain level.
- When the friction of the road surface is above a certain level.

### ***BAS operation off***

- The vehicle speed is below 10 km/h.
- The brake pedal is depressed over a certain conditions.
- The friction of the road surface is below a certain level.



## **WARNING**

**The system may not operate depending on driver's driving habit, the degree to which the brake pedal is depressed and the road surface condition.**

## Downhill Brake Control (DBC)

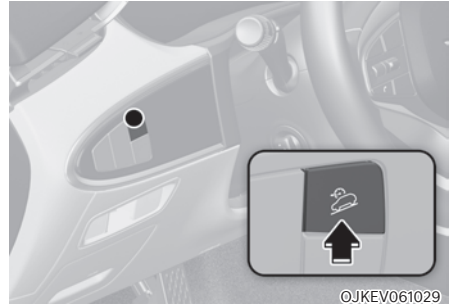





Downhill Brake Control assists the driver to descend down a steep hill without having to depress the brake pedal.

The system automatically applies the brakes to maintain vehicle speed below a certain speed and allows the driver to concentrate on steering the vehicle down hill.

The system is turned off whenever the READY indicator is OFF.

Press the button to turn on the system and press the button again to turn it off.

**System operation**

Mode	Indicator	Description
Standby	 Green light on	Press the Downhill Brake Control button when vehicle speed is under 60 km/h (37 mph). Downhill Brake Control will turn on and enter the standby mode. The system does not turn on if vehicle speed is over 60 km/h (37 mph).
Activated	 Green light blink	In the standby mode, Downhill Brake Control will activate under the following conditions: <ul style="list-style-type: none"> <li>• The hill is steep enough.</li> <li>• The brake pedal or accelerator pedal is not depressed.</li> <li>• MUD mode is selected from All Wheel Drive (AWD) multi terrain mode and vehicle speed is within 4-40km/h (2-25 mph) range (within 4-8 km/h (2-5 mph) when reversing).</li> </ul> Within the activation speed range 4-40km/h (2-25 mph), the driver can control the vehicle speed by depressing the brake pedal or accelerator pedal.
Deactivated	 Green light off	Downhill Brake Control will turn off under the following conditions: <ul style="list-style-type: none"> <li>• The Downhill Brake Control button is pressed again.</li> <li>• Vehicle speed is over 60 km/h (37 mph).</li> </ul>
	 Green light on	Downhill Brake Control will be deactivated but maintain the standby mode under the following conditions: <ul style="list-style-type: none"> <li>• The hill is not steep enough.</li> <li>• Vehicle speed is between 30-60 km/h (18-37 mph).</li> </ul>
System malfunction	 Yellow light on	The yellow warning light illuminates when the system may have malfunctioned or may not work properly during activation. If this occurs, Downhill Brake Control is deactivated. We recommend that the system be inspected by an authorized retailer of Genesis Branded products as soon as possible.



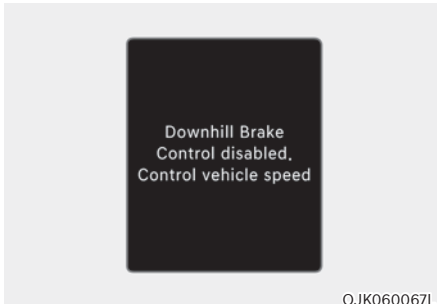

**Downhill Brake Control disabled. Control vehicle speed (manually)**

When Downhill Brake Control is not working properly this warning message will appear on the cluster LCD display and you will hear a warning sound. If this occurs, control vehicle speed by depressing the brake pedal.



**WARNING**

**Always turn off Downhill Brake Control on normal roads. The system might activate inadvertently from the standby mode when driving through speed bumps or making sharp curves.**

**i Information**

- Downhill Brake Control may not deactivate on steep inclines even though the brake pedal or accelerator pedal is depressed.
- Downhill Brake Control may not always maintain vehicle speed at a certain speed.
- Downhill Brake Control does not operate when:
  - The gear is in P (Park).
  - ESC is activated.
- Noise or vibration may occur from the brakes when Downhill Brake Control is activated.
- The rear stop light comes on when Downhill Brake Control is activated.
- When Downhill Brake Control (DBC) is activated, paddle shift operation is limited.

## Good braking practices



### **WARNING**

**Whenever leaving the vehicle or parking, always come to a complete stop and continue to depress the brake pedal. Shift the gear to the P (Park) position, then apply the parking brake, and press the Start/Stop button to the OFF position.**

**Vehicles parked with the parking brake not applied or not fully engaged may roll inadvertently and may cause injury to the driver and others. ALWAYS apply the parking brake before exiting the vehicle.**

Be aware of wet brakes. The brakes may get wet if the vehicle is driven through standing water or if it is washed. Your vehicle will not stop as quickly if the brakes are wet. Wet brakes may cause the vehicle to pull to one side.

To dry the brakes, apply the brakes lightly until the braking action returns to normal. If the braking action does not return to normal, stop as soon as it is safe to do so and we recommend that you call an authorized retailer of Genesis Branded products for assistance.

DO NOT drive with your foot resting on the brake pedal. Even light, but constant pedal pressure can result in the brakes overheating, brake wear, and possibly even brake failure.

If a tire goes flat while you are driving, apply the brakes gently and keep the vehicle pointed straight ahead while you slow down. When you are moving slowly enough for it to be safe to do so, pull off the road and stop in a safe location.

Keep your foot firmly on the brake pedal when the vehicle is stopped to prevent the vehicle from rolling forward.

## ALL WHEEL DRIVE (AWD) (IF EQUIPPED)

When All Wheel Drive (AWD) is activated, driving forces are distributed appropriately to front and rear wheels. It could improve driving performance by maximizing the driving force of vehicles on severe road conditions such as steep hills, unpaved, slippery, etc.

Advantage of electronic AWD

1. Improvement of straight stability
2. Improvement of driving performance on curve
3. Secure stability on severe condition such as wet and sandy roads.
4. Improvement of energy efficiency from driving mode automatic control.



### Information

AWD vehicles could change the engagement status of the motor according to the situation required. Auto changing the driving mode(2WD/4WD)helps improve energy efficiency and driving stability.



### WARNING

To reduce the risk of **SERIOUS INJURY** or **DEATH**:

- Avoid high speeds when cornering or turning.
- Do not make quick steering wheel movements, such as sharp lane changes or fast, sharp turns.
- The risk of a rollover is greatly increased if you lose control of your vehicle at highway speeds.
- Loss of control often occurs if two or more wheels drop off the roadway and the driver over steers to reenter the roadway.
- In the event your vehicle leaves the roadway, do not steer sharply. Instead, slow down before pulling back into the travel lanes.

### NOTICE

- Do not drive in water if the water level is higher than the bottom of the vehicle.
- Check your brake condition once you are out of mud or water. Depress the brake pedal several times as you move slowly until you feel normal braking condition is returned.
- Shorten your scheduled maintenance interval if you drive in off-road conditions such as sand, mud or water (see "Maintenance Under Severe Usage Conditions" section in chapter 9).
- Always wash your vehicle thoroughly after off road use, especially the bottom of the vehicle.
- Be sure to equip the vehicle with four tires of the same size and type.
- Make sure that a full time AWD vehicle is towed by a flat bed tow truck.

## All Wheel Drive (AWD) operation

### *Auto AWD mode (Normal driving)*

If the AWD system determines there is a need for four wheel drive, the motor's driving power is distributed to all four wheels automatically.

### *Multi terrain mode*

In the multi terrain mode, four-wheel drive, reduction gear and braking is controlled to achieve optimal driving performance depending on the mode selected (SNOW/MUD/SAND).

**All Wheel Drive (AWD) selection**

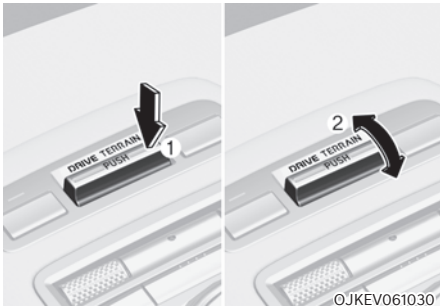

Push (1) the DRIVE/TERRAIN switch to change from normal driving mode to multi terrain mode. Push the switch up or down (2) within 4 seconds to select SNOW, MUD or SAND.

Selected mode		Description
Auto AWD (Normal driving)	-	<ul style="list-style-type: none"> <li>Use this mode when driving on normal roads.</li> <li>Under normal operating conditions, the vehicle operates similar to conventional 2WD vehicles. If the system determines there is a need for four wheel drive, the vehicle's driving power is distributed to all four wheels automatically.</li> </ul>
SNOW		<ul style="list-style-type: none"> <li>Use this mode when driving on slippery roads.</li> <li>The vehicle's driving power is properly distributed to the wheels, to help start the vehicle stably on slippery roads or keep tires from slipping.</li> </ul>
MUD		<ul style="list-style-type: none"> <li>Use this mode when driving on muddy, unpaved or uneven roads</li> <li>The vehicle's driving power is properly distributed to the wheels, to secure sufficient driving force that will help start the vehicle.</li> </ul>
SAND		<ul style="list-style-type: none"> <li>Use this mode when driving on smooth, dry sand or deep gravel and unpaved roads.</li> <li>The vehicle's driving power is properly distributed to the wheels, to help drive safely on smooth, dry sand or deep gravel and unpaved roads.</li> </ul>

Be sure to maintain Auto AWD mode when driving on normal roads. If you drive with the Multi Terrain mode on normal roads or curved roads, it may damage AWD parts and cause vibration and noise. However, vibration and noise are normal conditions that will disappear when Auto AWD mode is selected. Also, when switching between Multi Terrain mode (SNOW, MUD or SAND) and Auto AWD, a sensation may be felt as driving power is delivered to the front and rear wheels.

**WARNING**

If the AWD warning light stays on the instrument cluster, your vehicle may have a malfunction with the AWD system. Whenever the AWD warning light illuminates we recommend that the vehicle be inspected by an authorized retailer of Genesis Branded products as soon as possible.

### **For safe AWD operation**

#### **Before driving**

- Make sure all passengers are wearing seat belts.
- Sit upright and closer to the steering wheel than usual. Adjust the steering wheel to a position comfortable for you to drive.

#### **Driving on snow-covered or icy roads**

- Start off slowly by applying the accelerator pedal gently.
- Use snow tires or tire chains.
- Keep sufficient distance between your vehicle and the vehicle in front of you.
- Avoid speeding, rapid acceleration, sudden brake applications, and sharp turns to prevent skids.
- It is difficult to start again if the vehicle stops on an uphill road. Keep your distance from other vehicles and drive slowly.

#### **Information**

**When using Snow Tires, mount them on all four wheels.**

**When using tire chains, install them on the rear tires.**

**However, driving speed must be below 30 km/h and minimize the driving distance.**

**High-speed or long-term driving with tire chains installed may malfunction or damage the AWD system.**

**For more details on Snow Tires and Tire Chains, refer to "Winter Driving" section later in this chapter.**

#### **Driving in sand or mud**

- Maintain slow and constant speed.
- Use tire chains driving in mud if necessary.
- Keep sufficient distance between your vehicle and the vehicle in front of you.
- Reduce vehicle speed and always check the road condition.
- Avoid speeding, rapid acceleration, sudden brake applications, and sharp turns to prevent getting stuck.

#### **NOTICE**

**When the vehicle is stuck in snow, sand or mud, place a nonslip material under the drive wheels to provide traction OR slowly spin the wheels in forward and reverse directions which causes a rocking motion that may free the vehicle.**

#### **Driving up or down hills**

- Driving uphill
  - Before starting off, check if it is possible to drive uphill.
  - Drive as straight as possible.
- Driving downhill
  - Do not change gear while driving downhill. Select gear before driving downhill.
  - Drive straight as possible.



#### **WARNING**

**Exercise extreme caution driving up or down steep hills. The vehicle may flip over depending on the grade, terrain, water and mud conditions.**



**WARNING**

Do not drive across the contour of steep hills. A slight change in the wheel angle can destabilize the vehicle, or a stable vehicle may lose stability if the vehicle stops its forward motion. Your vehicle may roll over and lead to a serious injury or death.

**Driving through water**

- Try to avoid driving in deep standing water.
- If you need to drive in water, stop your vehicle, set the vehicle in Multi Terrain mode and drive under 8 km/h (5 mph).
- Do not change gear while driving in water.



**CAUTION**

Always drive slowly in water. If you drive too fast, water may get into the motor compartment, causing your vehicle to suddenly stop.

**Additional driving conditions**

- Become familiar with the off-road conditions before driving.
- Always pay attention when driving off-road and avoid dangerous areas.
- Drive slowly when driving in heavy wind.
- Reduce vehicle speed when cornering. The center of gravity of AWD vehicles is higher than conventional 2WD vehicles, making them more likely to roll over when you rapidly turn corners.
- Always hold the steering wheel firmly when you are driving off-road.



**WARNING**

Do not grab the inside of the steering wheel when you are driving off-road. You may hurt your arm by a sudden steering maneuver or from steering wheel rebound due to an impact with objects on the ground. You could lose control of the steering wheel which may lead to serious injury or death.

**Emergency precautions**

*Tires*

When replacing tires, be sure to equip all four tires with the same size, type, tread patterns, brand and load-carrying capacity.



**WARNING**

Do not use tire and wheel with different size and type from the one originally installed on your vehicle. It can affect the safety and performance of your vehicle, which could lead to steering failure or rollover causing serious injury.

## WARNING



**Never start or run the vehicle while an AWD vehicle is raised on a jack. The vehicle can slip or roll off of a jack causing serious injury or death to you or those nearby.**

### **Towing**

AWD vehicles must be towed with a wheel lift and dollies or flatbed equipment with all the wheels off the ground. For more details, refer to "Towing" section in chapter 8.

### **Vehicle inspection**

- If the vehicle needs to be operated on a vehicle lift do not attempt to stop any of the four wheels from turning. This could damage the AWD system.
- Never engage the parking brake while running the vehicle on a car lift. This may damage the AWD system.

### **Dynamometer testing**

An AWD vehicle must be tested on a special four wheel chassis dynamometer.

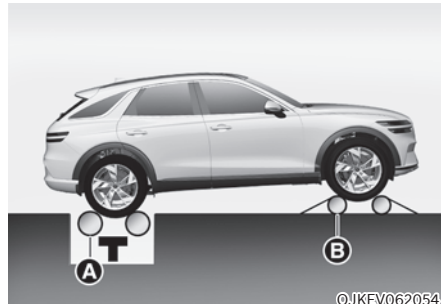

[A]: Roll tester (Speedometer),

[B]: Temporary free roller

An AWD vehicle should not be tested on a 2WD roll tester. If a 2WD roll tester must be used, perform the following procedure:

1. Check the tire pressures recommended for your vehicle.
2. Place the rear wheels on the roll tester for a speedometer test as shown in the illustration.
3. Release the parking brake.
4. Place the front wheels on the temporary free roller as shown in the illustration.

## WARNING

**Keep away from the front of the vehicle while the vehicle is in gear on the dynamometer. The vehicle can jump forward and cause serious injury or death.**

## ELECTRONIC CONTROL SUSPENSION (IF EQUIPPED)

Electronic Control Suspension controls the vehicle suspension automatically using vehicle sensors to maximize driving comfort by taking into account the driving conditions such as speed, surface of the road, cornering, braking and acceleration.

### System malfunction



### Check Electronic Suspension

When Electronic Control Suspension is not working properly, this warning message will appear on the cluster LCD display. If this occurs, we recommend that the system be inspected by an authorized retailer of Genesis Branded products.



## ELECTRONICALLY CONTROLLED SUSPENSION WITH ROAD PREVIEW (IF EQUIPPED)

Electronically Controlled Suspension with Road Preview controls the vehicle suspension automatically using the front view camera and vehicle sensors to maximize driving comfort by taking into account the driving conditions such as speed, surface of the road, cornering, braking and acceleration.

### Front view camera



OJKEV051076

[1]: Front view camera

The front view camera is a sensor that detects the front road. If the windshield or the front view camera is covered with snow, rain or foreign matters, the data collected by the camera is limited due to the degradation of the camera's performance. Always keep the front view camera clean.

### NOTICE

- **NEVER** install any accessories or stickers on the front windshield, or tint the front windshield.
- **NEVER** place any reflective objects (for example, white paper, mirror) over the dashboard. Any light reflection may prevent the system from functioning properly.
- Pay extreme caution to keep the camera dry.
- Never disassemble the camera assembly, or apply any impact on the camera assembly.

### *i* Information

We recommend that the system be inspected by an authorized retailer of Genesis Branded products when:

- The windshield glass is replaced.
- The front view camera or cover gets damaged or replaced.

## System malfunction



### Check electronic suspension

When Electronically Controlled Suspension with Road Preview is not working properly, this warning message will appear on the cluster LCD display. If this occurs, we recommend that the system be inspected by an authorized retailer of Genesis Branded products.

### **NOTICE**

**If the battery level is high or low, Electronically Controlled Suspension with Road Preview may not work temporarily to protect the system. If this occurs, 'Check Electronic Suspension' warning message will appear.**

## Limitations of the system

Electronically Controlled Suspension with Road Preview always operates while driving according to the vehicle's movement, and the preview function starts to work when the front view camera detects road conditions such as speed bumps. Therefore, the preview function is limited when there is an extreme condition that the front view camera may not work normally. In this case, the electronic control suspension function operates without the preview function in accordance with vehicle movement.

## DRIVE MODE INTEGRATED CONTROL SYSTEM (IF EQUIPPED)

### Selecting drive mode

Drive mode may be selected according to the driver's preference or road condition.

### Changing drive mode (ECO, COMFORT, SPORT)



The mode changes whenever the driver pushes the DRIVE MODE switch up or down.

The drive mode changes as below whenever the DRIVE MODE switch is pushed.

- ECO → COMFORT → SPORT

### Setting BRAKE mode

To set the BRAKE mode to adjust brake response, park the vehicle and shift the gear to P (Park). Go to 'Setup → Vehicle → Drive/Terrain mode → Brakes' in the infotainment system and select a mode.

- COMFORT: Brake response appropriate for comfort driving.
- SPORT: Brake response appropriate for dynamic driving.

### ECO, COMFORT, SPORT mode features

#### ECO mode

ECO mode is a driving mode that helps improve energy efficiency by limiting maximum vehicle power (torque), providing smooth vehicle response and driving the vehicle with the rear wheels (2WD).

Energy efficiency varies according to the driver's driving habit and road condition.

- When ECO mode is selected, the ECO indicator will illuminate on the instrument cluster and theme of the instrument cluster will change.

#### When ECO mode is activated:

- All wheel drive and sharp acceleration and deceleration is limited
- The vehicle will automatically convert between 2WD to AWD when:
  - i-Pedal or One Pedal Driving is operating
  - The temperature is low
  - Driving on a slope or a slippery road

#### COMFORT mode

COMFORT mode is a driving with auto changing the driving mode (2WD/AWD) on road condition.

***SPORT mode***

SPORT mode is a driving mode that provides sporty but firm riding by making the motor response more quickly, making the steering wheel heavier and driving the vehicle with all four wheels (AWD).

In SPORT mode, the energy efficiency may decrease.

- When SPORT mode is selected, the SPORT indicator will illuminate on the instrument cluster and theme of the instrument cluster will change.
- Whenever the vehicle is restarted, the drive mode will revert back to COMFORT mode. If SPORT mode is required, re-select SPORT mode.

## Drive modes characteristic

The characteristic of each components varies according to which drive mode is selected.

Drive mode	COMFORT	ECO	SPORT	TERRAIN
Characteristics	COMFORT driving mode	High electric energy efficiency mode	Sporty driving mode	SNOW, MUD, SAND
Button activation	Press	Press	Press	Press
Indicator on the cluster	-	ECO	SPORT	SNOW, MUD, SAND
Climate system control	COMFORT	ECO (ECO/COMFORT) *1	COMFORT	ECO/COMFORT
Speed Limit	-	-	-	-
Regenerative braking level	0~3			0~1

\*1: It is possible to set the driving condition for each drive mode, at the drive mode setting in Infotainment system, for detailed information, scan the QR code in a separately supplied simple manual.

\* Downhill Brake Control (DBC) is activated when MUD is selected during TERRAIN mode.

### Selecting multi terrain mode

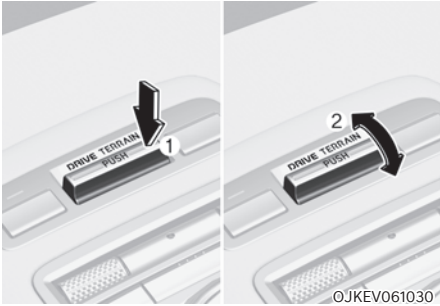

Multi terrain mode may be selected according to the driver's preference or road condition.



Push (1) the DRIVE/TERRAIN switch to change from Drive mode to Multi terrain mode. After the switch is pushed, push the DRIVE/TERRAIN switch up or down (2) within 4 seconds to select SNOW, MUD or SAND. When the DRIVE/TERRAIN switch is pushed again, the previous Drive mode will be reselected.

For more details on Terrain mode, refer to “All Wheel Drive” section in this chapter.

## BOOST MODE



OJKEV061033

Boost mode will maximize motor performance for up to 10 seconds for rapid acceleration.

### Using Boost mode

Press the boost button on the steering wheel while driving to enable boost mode.

While on boost mode, the motor overboost activates. The boost mode is maintained for 10 seconds and turns off automatically.



### CAUTION

- **The driver should hold the responsibility to safely drive and control the vehicle when using Boost mode.**
- **Do not attempt dangerous driving while using Boost mode.**

### Boost Mode limitations

Boost mode will turn off during operation or will not operate when:

- The gear is shifted to N (Neutral), R (Reverse), or P (Park)
- The motor or the battery has a problem
- The high voltage battery charge is insufficient
- The terrain mode or trailer mode is enabled

## ACTIVE NOISE CONTROL-ROAD (IF EQUIPPED)

Active noise control-road helps reduce noise caused while driving.

The system may not operate properly in the following conditions:

- Any of the window is open
- Any of the door is open
- The tailgate is open
- Vehicle's microphone and speaker is blocked by loads

### System malfunction

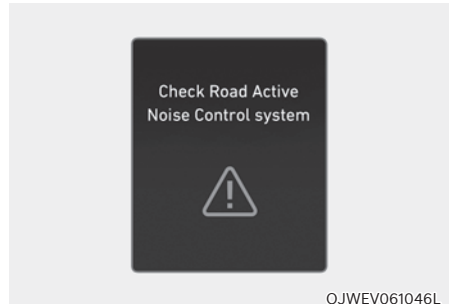

OJWEV061046L

When Active noise control-road is not working properly, this warning message will appear on the cluster LCD display. If this occurs, we recommend that the system be inspected by an authorized retailer of Genesis Branded products.

## SPECIAL DRIVING CONDITIONS

### Hazardous driving conditions

When hazardous driving elements are encountered such as water, snow, ice, mud and sand, take the following precautions:

- Drive cautiously and maintain a longer braking distance.
- Avoid abrupt braking or steering.
- When your vehicle is stuck in snow, mud, or sand, use second gear. Accelerate slowly to avoid unnecessary wheel spin.
- Put sand, rock salt, tire chains or other non-slip materials under the wheels to provide additional traction while the vehicle becomes stuck in ice, snow, or mud.



#### WARNING

Changing the tire speed suddenly could cause the tires to skid while driving on slippery surface. Be careful when driving on slippery surfaces.

### Rocking the vehicle

If it is necessary to rock the vehicle to free it from snow, sand, or mud, first turn the steering wheel right and left to clear the area around your front wheels. Then, shift back and forth between R (Reverse) and a forward gear.

Try to avoid spinning the wheels, and do not race the vehicle.

To prevent reduction gear wear, wait until the wheels stop spinning before shifting gears. Release the accelerator pedal while shifting, and press lightly on the accelerator pedal while the reduction gear is in gear. Slowly spinning the wheels in forward and reverse directions causes a rocking motion that may free the vehicle.



#### WARNING

If the vehicle is stuck and excessive wheel spin occurs, the temperature in the tires can increase very quickly. If the tires become damaged, a tire blow out or tire explosion can occur. This condition is dangerous - you and others may be injured. Do not attempt this procedure if people or objects are anywhere near the vehicle.

If you attempt to free the vehicle, the vehicle can overheat quickly, possibly causing an motor compartment fire or other damage. Try to avoid spinning the wheels as much as possible to prevent overheating of either the tires or the motor. **DO NOT** allow the vehicle to spin the wheels above 56 km/h (35 mph).



#### Information

The ESC system must be turned OFF before rocking the vehicle.



**NOTICE**

**If you are still stuck after rocking the vehicle a few times, have the vehicle pulled out by a tow vehicle to avoid motor overheating, possible damage to the reduction gear, and tire damage. See “Towing” section in chapter 8.**

**Smooth cornering**

Avoid braking or gear changing in corners, especially when roads are wet. Ideally, corners should always be taken under gentle acceleration.

**Driving at night**

Night driving presents more hazards than driving in the daylight. Here are some important tips to remember:

- Slow down and keep more distance between you and other vehicles, as it may be more difficult to see at night, especially in areas where there may not be any street lights.
- Adjust your mirrors to reduce the glare from other drivers' headlamps.
- Keep your headlamps clean and properly aimed. Dirty or improperly aimed headlamps will make it much more difficult to see at night.
- Avoid staring directly at the headlamps of oncoming vehicles. You could be temporarily blinded, and it will take several seconds for your eyes to readjust to the darkness.

**Driving in the rain**

Rain and wet roads can make driving dangerous. Here are a few things to consider when driving in the rain or on slick pavement:

- Slow down and allow extra following distance. A heavy rainfall makes it harder to see and increases the distance needed to stop your vehicle.
- Turn OFF your Smart Cruise Control (SCC). (if equipped)
- Replace your windshield wiper blades when they show signs of streaking or missing areas on the windshield.
- Be sure your tires have enough tread. If your tires do not have enough tread, making a quick stop on wet pavement can cause a skid and possibly lead to an accident. **See “Tire Tread” section in chapter 9.**
- Turn on your headlamps to make it easier for others to see you.
- Driving too fast through large puddles can affect your brakes. If you must go through puddles, try to drive through them slowly.
- If you believe your brakes may be wet, apply them lightly while driving until normal braking operation returns.

### ***Hydroplaning***

If the road is wet enough and you are going fast enough, your vehicle may have little or no contact with the road surface and actually ride on the water. The best advice is SLOW DOWN when the road is wet.

**The risk of hydroplaning increases as the depth of tire tread decreases, refer to “Tire Tread” section in chapter 9.**

### **Driving in flooded areas**

Avoid driving through flooded areas unless you are sure the water is no higher than the bottom of the wheel hub. Drive through any water slowly. Allow adequate stopping distance because brake performance may be reduced.

After driving through water, dry the brakes by gently applying them several times while the vehicle is moving slowly.

### **Highway driving**

#### ***Tires***

Adjust the tire inflation, as specified. Under-inflation may overheat or damage the tires.

Do not install worn-out or damaged tires, which may reduce traction or fail the braking operation.

#### **Information**

**Never over-inflate your tires above the maximum inflation pressure, as specified on your tires.**

#### ***Coolant and high voltage battery***

Driving at higher speeds on the highway consumes more electric energy and is less efficient than driving at a slower, more moderate speed. Maintain a moderate speed in order to conserve electric energy when driving on the highway.

Be sure to check both the coolant level and the electric energy level before driving.

## Reducing the risk of a rollover

Your multi-purpose passenger vehicle is defined as a Sports Utility Vehicle (SUV). SUV's have higher ground clearance and a narrower track to make them capable of performing in a wide variety of off-road applications. The specific design characteristics give them a higher center of gravity than ordinary vehicles making them more likely to roll over if you make abrupt turns. Utility vehicles have a significantly higher rollover rate than other types of vehicles. Due to this risk, driver and passengers are strongly recommended to buckle their seat belts. In a rollover crash, an unbelted person is significantly more likely to die than a person wearing a seat belt.

There are steps that a driver can make to reduce the risk of a rollover. If at all possible, avoid sharp turns or abrupt maneuvers, do not load your vehicle with heavy cargo on the roof, and never modify your vehicle in any way.



### WARNING

**Utility vehicles have a significantly higher rollover rate than other types of vehicles. To prevent rollovers or loss of control:**

- **Take corners at slower speeds than you would with a passenger vehicle.**
- **Avoid sharp turns and abrupt maneuvers.**
- **Do not modify your vehicle in any way that you would raise the center of gravity.**
- **Keep tires properly inflated.**
- **Do not carry heavy cargo on the roof.**



### WARNING

**In a rollover crash, an unbelted person is significantly more likely to die than a person wearing a seat belt. Make sure all passengers are wearing their seat belts.**

## WINTER DRIVING

The severe weather conditions of winter quickly wear out tires and cause other problems. To minimize winter driving problems, you should take the following suggestions:

### Snow or icy conditions

You need to keep sufficient distance between your vehicle and the vehicle in front of you.

Apply the brakes gently. Speeding, rapid acceleration, sudden brake applications, and sharp turns are potentially very hazardous practices. Sudden brake applications on snowy or icy roads may cause the vehicle to skid.

To drive your vehicle in deep snow, it may be necessary to install tire chains on your tires.

Always carry emergency equipment. Some of the items you may want to carry include tire chains, tow straps or chains, a flashlight, emergency flares, sand, a shovel, jumper cables, a window scraper, gloves, ground cloth, coveralls, a blanket, etc.

### Snow tires



#### WARNING

**Snow tires should be equivalent in size and type to the vehicle's standard tires. Otherwise, the safety and handling of your vehicle may be adversely affected.**

We recommend that you use snow tires when road temperature is below 7°C (45°F). Refer to the below chart, and mount the recommended snow tire for your vehicle.

Standard tire		Recommended snow tire	
Tire size	Wheel size	Tire size	Wheel size
235/55 R19	8.0J x 19	235/55 R19	8.0J x 19
265/45 R20	8.5J x 20	265/45 R20	8.5J x 20

If you mount snow tires on your vehicle, make sure to use the same Inflation pressure as the original tires. Mount snow tires on all four wheels to balance your vehicle's handling in all weather conditions. The traction provided by snow tires on dry roads may not be as high as your vehicle's original equipment tires. Check with the tire dealer for maximum speed recommendations.

### **Summer tires**

- Summer tires are used to maximize the driving performance on dry roads.
- If the temperature is below 7°C (44°F) or you are driving on snowy or icy roads, the summer tires lose their brake performance and traction as the tire grip weakens significantly.
- If the temperature is below 7°C (44°F) or you are driving on snowy or icy roads, mount snow tires or all-season tires of the same size with your vehicle's standard tire for safe driving. Both snow and all-season tires have M+S markings.
- When using the M+S tires, use tires with the same tread produced by the same manufacturer for safe driving.
- When driving with the M+S tires with the lower maximum allowable speed than that of the vehicle's standard summer tire, be careful not to exceed the speed allowed for the M+S tires.

### **Tire chains (Auto sock)**



Since the sidewalls of radial tires are thinner, they can be damaged by mounting some types of snow chains on them. Therefore, the use of snow tires is recommended instead of snow chains.

Do not mount tire chains on vehicle equipped with aluminum wheels; snow chains may cause damage to the wheels. If possible, use AutoSock (fabric snow chain). Damage to your vehicle caused by improper snow chain use is not covered by your vehicle manufacturer's warranty.

When using tire chains, install tire chains only on the rear tires.



## WARNING

The use of AutoSock (fabric snow chain) may adversely affect vehicle handling:

- Drive less than 30 km/h (20 mph) or the chain manufacturer's recommended speed limit, whichever is lower.
- Drive carefully and avoid bumps, holes, sharp turns, and other road hazards, which may cause the vehicle to bounce.
- Avoid sharp turns or locked wheel braking.



## Information

- Install AutoSock (fabric snow chain) only in pairs and on the rear tires. It should be noted that installing AutoSock (fabric snow chain) on the tires will provide a greater driving force, but will not prevent side skids.
- Do not install studded tires without first checking local and municipal regulations for possible restrictions against their use.

## Chain Installation

When installing tire chains, follow the manufacturer's instructions and mount them as tightly possible. Drive slowly (less than 30 km/h (20 mph)) with chains installed. If you hear the chains contacting the body or chassis, stop and tighten them. If they still make contact, slow down until the noise stops. Remove the tire chains as soon as you begin driving on cleared roads.

When mounting snow chains, park the vehicle on level ground away from traffic. Turn on the vehicle Hazard Warning Flasher and place a triangular emergency warning device behind the vehicle (if available). Always place the vehicle in P (Park), apply the parking brake and turn off the vehicle before installing snow chains.

## NOTICE

When using AutoSock (fabric snow chain):

- Wrong size chains or improperly installed chains can damage your vehicle's brake lines, suspension, body and wheels.
- If you hear noise caused by chains contacting the body, retighten the chain to prevent contact with the vehicle body.
- To prevent body damage, retighten the chains after driving 0.5~1.0 km (0.3~0.6 miles).

## Winter precautions

### Check battery and cables

Winter temperatures affect battery performance. **Inspect the battery and cables, as specified in chapter 9.** We recommend that the battery charging level be checked by an authorized retailer of Genesis Branded products or in a service station.

### To prevent locks from freezing

To prevent the locks from being frozen, spray approved de-icing fluid or glycerin into key holes. When a lock opening is already covered with ice, spray approved de-icing fluid over the ice to remove it. When an internal part of a lock freezes, try to thaw it with a heated key. Carefully use the heated key to avoid an injury.

### Use approved window washer anti-freeze solution in system

To prevent the window washer from being frozen, add authorized window washer anti-freeze solution, as specified on the window washer container. We recommend that the window washer anti-freeze solution is available from an authorized retailer of Genesis Branded products, and most vehicle accessory outlets. Do not use coolant or other types of anti-freeze solution, to prevent any damage to the vehicle paint.

### Do not let your parking brake freeze

Under some conditions your parking brake can freeze in the engaged position. This is most likely to happen when there is an accumulation of snow or ice around or near the rear brakes or if the brakes are wet. When there is the risk that your parking brake may freeze, temporarily apply it with the gear in P (Park). Also, block the rear wheels in advance, so the vehicle may not roll. Then, release the parking brake.

### Do not let ice and snow accumulate underneath

Under some conditions, snow and ice can build up under the fenders and interfere with the steering. When driving in such conditions during the severe winter, you should check underneath the vehicle on a regular basis, to ensure that the front wheels and the steering components is unblocked.

### Carry emergency equipment

In accordance with weather conditions, you should carry appropriate emergency equipment, while driving. Some of the items you may want to carry include tire chains, tow straps or chains, flashlight, emergency flares, sand, shovel, jumper cables, window scraper, gloves, ground cloth, coveralls, blanket, etc.

### Do not place objects or materials in the motor compartment

Putting objects or materials in the motor compartment may cause an motor failure. Such damage will not be covered by the manufacturer's warranty.

### **Do not let your parking brake freeze**

Under some conditions your parking brake can freeze in the engaged position. This is most likely to happen when there is an accumulation of snow or ice around or near the rear brakes or if the brakes are wet. When there is the risk that your parking brake may freeze, temporarily apply it with the gear in P (Park). Also, block the rear wheels in advance, so the vehicle may not roll. Then, release the parking brake.

### **Do not let ice and snow accumulate underneath**

Under some conditions, snow and ice can build up under the fenders and interfere with the steering. When driving in such conditions during the severe winter, you should check underneath the vehicle on a regular basis, to ensure that the front wheels and the steering components is unblocked.

### **Carry emergency equipment**

In accordance with weather conditions, you should carry appropriate emergency equipment, while driving. Some of the items you may want to carry include tire chains, tow straps or chains, flashlight, emergency flares, sand, shovel, jumper cables, window scraper, gloves, ground cloth, coveralls, blanket, etc.

### **Do not place objects or materials in the motor compartment**

Putting objects or materials in the motor compartment may cause an motor failure or combustion, because they may block the motor cooling. Such damage will not be covered by the manufacturer's warranty.



## TRAILER TOWING

If you are considering to tow with your vehicle, you should first your country's legal requirements. As laws vary the requirements for towing trailers, cars, or other types of vehicles or apparatus may differ. Ask an authorized retailer of Genesis Branded products for further details before towing.

Remember that trailering is different than just driving your vehicle by itself. Trailering means changes in handling, durability, and fuel economy. Successful, safe trailering requires correct equipment, and it has to be used properly. Damage to your vehicle caused by improper trailer towing is not covered by your vehicle manufacturer's warranty. This section contains many time-tested, important trailering tips and safety rules. Many of these are important for your safety and that of your passengers. Please read this section carefully before you pull a trailer.



### WARNING

Take the following precautions:

- **If you don't use the correct equipment and/or drive improperly, you can lose control of the vehicle when you are pulling a trailer. For example, if the trailer is too heavy, the braking performance may be reduced. You and your passengers could be seriously or fatally injured. Pull a trailer only if you have followed all the steps in this section.**
- **Before towing, make sure the total trailer weight, GCW (Gross Combination Weight), GVW (Gross Vehicle Weight), GAW (Gross Axle Weight) and trailer tongue load are all within the limits.**

### *i* Information - For Europe

- **The technically permissible maximum load on the rear axle(s) may be exceeded by not more than 15 % and the technically permissible maximum laden mass of the vehicle may be exceeded by not more than 10% or 100 kg (220.4 lbs), whichever value is lower. In this case, do not exceed 100 km/h (62.1 mph) for vehicle of category M1 or 80 km/h (49.7 mph) for vehicle of category N1.**
- **When a vehicle of category M1 is towing a trailer, the additional load imposed at the trailer coupling device may cause the tire maximum load ratings to be exceeded, but not by more than 15%. In this case, do not exceed 100 km/h (62.1 mph) and increase the tire inflation pressure by at least 0.2 bar.**
- \* M1: passenger vehicle (9-seater or under)
- \* N1: commercial vehicle (3.5 ton or under)

### If you decide to pull a trailer?

Here are some important points if you decide to pull a trailer:

- Consider using a sway control. You can ask a trailer hitch dealer about sway control.
- Do not do any towing with your vehicle during its first 2,000 km (1,200 miles) in order to allow the motor to properly break in. Failure to heed this caution may result in serious motor or reduction gear damage.
- When towing a trailer, be sure to consult an authorized retailer of Genesis Branded products for further information on additional requirements such as a towing kit, etc.
- Always drive your vehicle at a moderate speed (less than 100 km/h (60 mph)) or posted towing speed limit.
- On a long uphill grade, do not exceed 70 km/h (45 mph) or the posted towing speed limit, whichever is lower.
- Carefully observe the weight and load limits provided in the following pages.

### Trailer weight

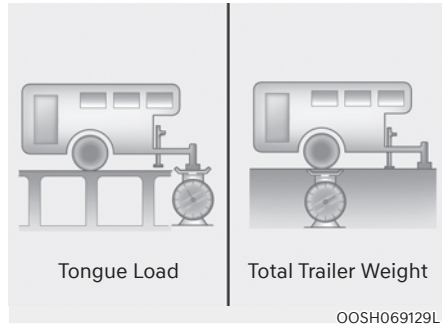

What is the maximum safe weight of a trailer? It should never weigh more than the maximum trailer weight with trailer brakes. But even that can be too heavy. It depends on how you plan to use your trailer. For example, speed, altitude, road grades, outside temperature and how often your vehicle is used to pull a trailer are all important. The ideal trailer weight can also depend on any special equipment that you have on your vehicle.

### Tongue load

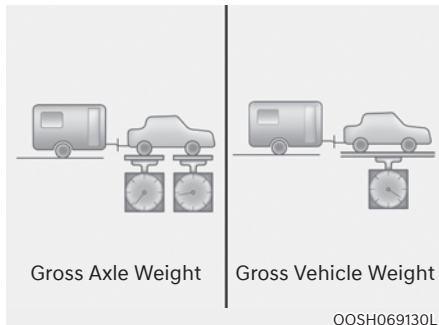

The tongue load is an important weight to measure because it affects the total Gross Vehicle Weight (GVW) of your vehicle. The trailer tongue should weigh a maximum of 10% of the total loaded trailer weight, within the limits of the maximum trailer tongue load permissible.

After you've loaded your trailer, weigh the trailer and then the tongue, separately, to see if the weights are proper. If they aren't, you may be able to correct them simply by moving some items around in the trailer.



### WARNING

Take the following precautions:

- Never load a trailer with more weight in the rear than in the front. The front should be loaded with approximately 60% of the total trailer load; the rear should be loaded with approximately 40% of the total trailer load.
- Never exceed the maximum weight limits of the trailer or trailer towing equipment. Improper loading can result in damage to your vehicle and/or personal injury. Check weights and loading at a commercial scale or highway patrol office equipped with scales.

**Reference weight and distance hen towing a trailer**

Item		Without trailer package	With trailer package
Maximum trailer weight kg (lbs.)	With brake system	-	1,800 (3,970)
	Without brake system	-	750 (1653)
Maximum permissible static vertical load on the coupling device kg (lbs.)		-	180 (397)
Recommended distance from rear wheel center to coupling point mm (inch)		-	1075 (42.32)

## Trailer towing equipment

### Hitches

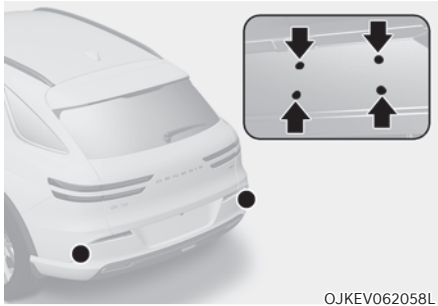

OJKEV062058L

### **i** Information

**The mounting hole for hitches are located on both sides of the underbody behind the rear tires.**

It's important to have the correct hitch equipment. Crosswinds, large trucks going by, and rough roads are a few reasons why you'll need the right hitch. Here are some rules to follow:

- Do you have to make any holes in the body of your vehicle when you install a trailer hitch? If you do, then be sure to seal the holes later when you remove the hitch. If you don't seal them, carbon monoxide (CO) from your exhaust can get into your vehicle, as well as dirt and water.
- The bumpers on your vehicle are not intended for hitches. Do not attach rental hitches or other bumper-type hitches to them. Use only a frame-mounted hitch that does not attach to the bumper.
- Any part of the rear number plate or lighting devices of the vehicle must not be obscured by the mechanical coupling device.  
If the rear number plate and/or lighting devices can be obscured partially by any part of the mechanical coupling device, mechanical coupling devices that can not be easily removed or repositioned without use of any tools, except an easily operated (for example, an effort not exceeding 20Nm) release key which is supplied by the manufacturer of the coupling device, are not permitted for use.  
Please note that the mechanical coupling device that is fitted and not in use must always be removed or repositioned if the rear number plate and/or rear lighting devices are obscured by any part of the mechanical coupling device.
- A Genesis Branded Vehicle trailer hitch accessory is available at an authorized retailer of Genesis Branded products.

### Safety chains

You should always attach chains between your vehicle and your trailer.

Instructions about safety chains may be provided by the hitch manufacturer or trailer manufacturer. Follow the manufacturer's recommendation for attaching safety chains. Always leave just enough slack so you can turn with your trailer. And, never allow safety chains to drag on the ground.

### Trailer brakes

If your trailer is equipped with a braking system, make sure it conforms to your country's regulations and that it is properly installed and operating correctly.

If your trailer weighs more than the maximum trailer weight without trailer brakes loaded, then it needs its own brakes and they must be adequate. Be sure to read and follow the instructions for the trailer brakes so you'll be able to install, adjust and maintain them properly. Be sure not to modify your vehicle's brake system.



### WARNING

**Do not use a trailer with its own brakes unless you are absolutely certain that you have properly set up the brake system. This is not a task for amateurs. Use an experienced, competent trailer shop for this work.**

### Driving with a trailer

Towing a trailer requires a certain amount of experience. Before setting out for the open road, you must get to know your trailer. Acquaint yourself with the feel of handling and braking with the added weight of the trailer. And always keep in mind that the vehicle you are driving is now longer and not nearly as responsive as your vehicle is by itself.

Before you start, check the trailer hitch and platform, safety chains, electrical connector(s), lights, tires and brakes.

During your trip, occasionally check to be sure that the load is secure, and that the lights and trailer brakes are still working.



### Information

**When the ambient temperature is lower than 0°C (32°F) and the remaining high voltage battery is low, the power of the vehicle with a trailer can be dropped, causing a trouble in acceleration or drop of the speed when driving hills.**

**When driving with a trailer, be sure to charge the high voltage battery more than 50% if the ambient temperature is lower than 0°C (32°F).**

Eco drive mode towing is a mode for light loads. If the towing weight is large or climbing, the vehicle may not have enough power. In this case, it is necessary to shift to the normal drive mode and drive.

### ***Distance***

Stay at least twice as far behind the vehicle ahead as you would when driving your vehicle without a trailer. This can help you avoid situations that require heavy braking and sudden turns.

### ***Passing***

You will need more passing distance up ahead when you're towing a trailer. And, because of the increased vehicle length, you'll need to go much farther beyond the passed vehicle before you can return to your lane.

### ***Backing up***

Hold the bottom of the steering wheel with one hand. Then, to move the trailer to the left, move your hand to the left. To move the trailer to the right, move your hand to the right. Always back up slowly and, if possible, have someone guide you.

### ***Making turns***

When you're turning with a trailer, make wider turns than normal. Do this so your trailer won't strike soft shoulders, curbs, road signs, trees, or other objects. Avoid jerky or sudden maneuvers. Signal well in advance.

### ***Turn signals***

When you tow a trailer, your vehicle has to have a different turn signal flasher and extra wiring. The green arrows on your instrument panel will flash whenever you signal a turn or lane change. Properly connected, the trailer lights will also flash to alert other drivers you're about to turn, change lanes, or stop.

When towing a trailer, the green arrows on your instrument panel will flash for turns even if the bulbs on the trailer are burned out. Thus, you may think drivers behind you are seeing your signals when, in fact, they are not. It's important to check occasionally to be sure the trailer bulbs are still working. You must also check the lights every time you disconnect and then reconnect the wires.



### **WARNING**

**Do not connect a trailer lighting system directly to your vehicle's lighting system. Use an approved trailer wiring harness. Failure to do so could result in damage to the vehicle electrical system and/or personal injury. Consult an authorized retailer of Genesis Branded products for assistance.**

### ***Driving on hills***

Reduce speed before you start down a long or steep downgrade.

On a long uphill grade, reduce your speed to around 70 km/h (45 mph) to reduce the possibility of motor overheating.

### **NOTICE**

#### **To prevent motor overheating:**

- **If you tow a trailer with the maximum gross vehicle weight and maximum trailer weight, it can cause the motor to overheat. When driving in such conditions, allow the motor to idle until it cools down. You may proceed once the motor has cooled sufficiently.**
- **When towing a trailer, your vehicle speed may be much slower than the general flow of traffic, especially when climbing an uphill grade. Use the right hand lane when towing a trailer on an uphill grade. Choose your vehicle speed according to the maximum posted speed limit for vehicles with trailers, the steepness of the grade, and your trailer weight.**

### ***Parking on hills***

Generally, if you have a trailer attached to your vehicle, you should not park your vehicle on a hill.

However, if you ever have to park your trailer on a hill, here's how to do it:

1. Pull the vehicle into the parking space.  
Turn the steering wheel in the direction of the curb (right if headed down hill, left if headed up hill).
2. Shift the gear to P (Park).
3. Set the parking brake and shut off the vehicle.
4. Place wheel chocks under the trailer wheels on the down hill side of the wheels.
5. Start the vehicle, hold the brakes, shift to neutral, release the parking brake and slowly release the brakes until the trailer chocks absorb the load.
6. Reapply the brakes and parking brakes.
7. Shift the gear to P (Park).
8. Shut off the vehicle and release the vehicle brakes but leave the parking brake set.



### **WARNING**

#### **To prevent serious or fatal injury:**

- **Do not get out of the vehicle without the parking brake firmly set. If you have left the vehicle running, the vehicle can move suddenly. You and others could be seriously or fatally injured.**
- **Do not apply the accelerator pedal to hold the vehicle on an uphill.**



### ***Driving the vehicle after it has been parked on a hill***

1. With the gear in P (Park), apply your brakes and hold the brake pedal down while you:
  - Start your vehicle;
  - Shift into gear; and
  - Release the parking brake.
2. Slowly remove your foot from the brake pedal.
3. Drive slowly until the trailer is clear of the chocks.
4. Stop and have someone pick up and store the chocks.

### **Maintenance when towing a trailer**

Your vehicle will need service more often when you regularly pull a trailer. Important items to pay particular attention to include reduction gear fluid, axle lubricant and cooling system fluid. Brake condition is another important item to frequently check. If you're trailering, it's a good idea to review these items before you start your trip. Don't forget to also maintain your trailer and hitch. Follow the maintenance schedule that accompanied your trailer and check it periodically. Preferably, conduct the check at the start of each day's driving. Most importantly, all hitch nuts and bolts should be tight.

#### **NOTICE**

##### **To prevent vehicle damage:**

- **Due to higher load during trailer usage, overheating might occur on hot days or during uphill driving.**
- **When towing check reduction gear fluid more frequently.**

## VEHICLE WEIGHT

Two labels on your driver's door sill show how much weight your vehicle was designed to carry: the Tire and Loading Information Label and the Certification Label.

Before loading your vehicle, familiarize yourself with the following terms for determining your vehicle's weight ratings, from the vehicle's specifications and the Certification Label:

### Base Curb Weight

This is the weight of the vehicle including high voltage battery and all standard equipment. It does not include passengers, cargo, or optional equipment.

### Vehicle Curb Weight

This is the weight of your new vehicle when you picked it up from your dealer plus any aftermarket equipment.

### Cargo Weight

This figure includes all weight added to the Base Curb Weight, including cargo and optional equipment.

### GAW (Gross Axle Weight)

This is the total weight placed on each axle (front and rear) - including vehicle curb weight and all payload.

### GAWR (Gross Axle Weight Rating)

This is the maximum allowable weight that can be carried by a single axle (front or rear). These numbers are shown on the Certification Label. The total load on each axle must never exceed its GAWR.

### GVW (Gross Vehicle Weight)

This is the Base Curb Weight plus actual Cargo Weight plus passengers.

### GVWR (Gross Vehicle Weight Rating)

This is the maximum allowable weight of the fully loaded vehicle (including all options, equipment, passengers and cargo). The GVWR is shown on the Certification Label located on the driver's door sill.

## Overloading



### WARNING

**The Gross Axle Weight Rating (GAWR) and the Gross Vehicle Weight Rating (GVWR) for your vehicle are on the Certification Label attached to the driver's (or front passenger's) door. Exceeding these ratings can cause an accident or vehicle damage. You can calculate the weight of your load by weighing the items (and people) before putting them in the vehicle. Be careful not to overload your vehicle.**

# 7. Driver assistance system

Due to the infotainment software update, the description of each function of the driver assistance system may differ from the owner's manual.

In this case, for detailed information on updates, scan the QR code in the separately supplied simple manual.

## Driving safety

Forward Collision-Avoidance Assist (FCA) .....	7-2
Lane Keeping Assist (LKA) .....	7-27
Blind-Spot Collision-Avoidance Assist (BCA) .....	7-33
Safe Exit Warning (SEW).....	7-46
Safe Exit Assist (SEA) .....	7-51
Manual Speed Limit Assist (MSLA) .....	7-57
Intelligent Speed Limit Assist (ISLA).....	7-60
Driver Attention Warning (DAW) .....	7-66
Forward Attention Warning (FAW).....	7-72
Blind-Spot View Monitor (BVM).....	7-77

## Driving convenience

Smart Cruise Control (SCC) .....	7-79
Navigation-based Smart Cruise Control (NSCC).....	7-97
Lane Following Assist (LFA) .....	7-104
Highway Driving Assist (HDA).....	7-108

## Parking safety

Rear View Monitor (RVM) .....	7-121
Surround View Monitor (SVM) .....	7-126
Rear Cross-Traffic Collision-Avoidance Assist (RCCA) .....	7-131
Forward/Reverse Parking Distance Warning (PDW) .....	7-143
Reverse Parking Collision-Avoidance Assist (PCA) .....	7-149

## Parking Convenience

Remote Smart Parking Assist (RSPA) .....	7-158
--	-------

Declaration of conformity .....	7-185
---------------------------------	-------

## FORWARD COLLISION-AVOIDANCE ASSIST (FCA) (IF EQUIPPED)

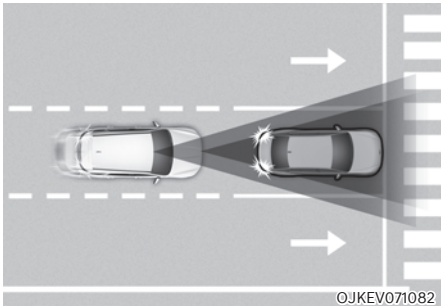

Forward Collision-Avoidance Assist is designed to help detect and monitor the vehicle ahead or help detect a pedestrian or cyclist in the roadway and warn the driver that a collision is imminent with a warning message and warning and application of emergency braking.

In addition, if equipped with front corner radars, when driving at high speeds, Forward Collision-Avoidance Assist will help detect vehicles in front and adjacent lanes. If a collision is imminent when changing lanes, Forward Collision-Avoidance Assist will apply emergency braking to help prevent a collision.

### Junction Turning function

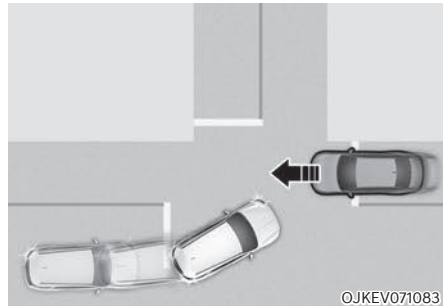

Junction Turning function can help avoid a collision with an oncoming vehicle in an adjacent lane when turning left (left-hand drive) or right (right-hand drive) at a crossroad with the turn signal on by applying emergency braking.

### Junction Crossing function (if equipped)

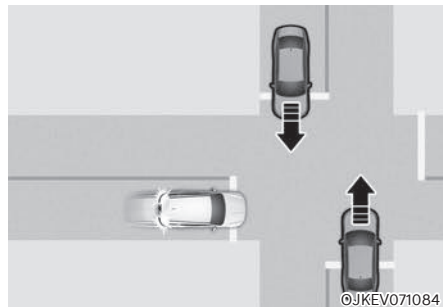

Junction Crossing function can help avoid a collision with oncoming vehicles on the left or right side when crossing an intersection by applying emergency braking.

### Lane-Change Oncoming function (if equipped)

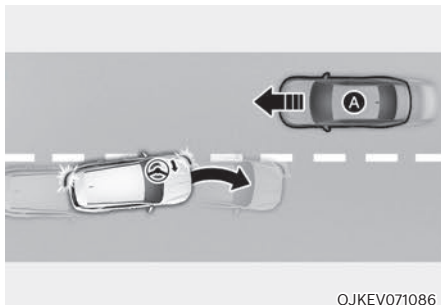

[A]: Oncoming vehicle

Lane-Change Oncoming function helps avoid a collision with an oncoming vehicle when changing lanes by assisting the driver's steering.

### Lane-Change Side function (if equipped)

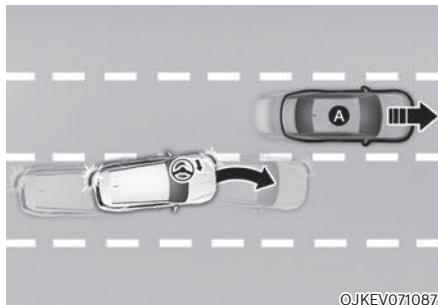

[A]: Front-side vehicle

Lane-Change Side function helps avoid a collision with the vehicle ahead in the next lane when changing lanes by assisting the driver's steering.

### Evasive Steering Assist function (if equipped)

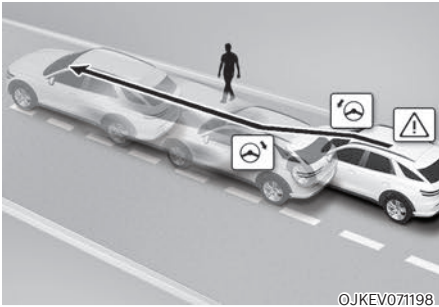

- Driver steering assist  
Evasive Steering Assist function helps avoid a collision with a vehicle, pedestrian or cyclist ahead in the same lane. When a risk of collision is detected, Evasive Steering Assist function will warn the driver and if the driver steers to avoid collision it will assist the driver's steering.
- Evasive steering assist  
Evasive Steering Assist function helps avoid a collision with a pedestrian or cyclist ahead in the same lane. When a risk of collision is detected, Evasive Steering Assist function will warn the driver and if there is space to avoid collision in the lane, it will assist the driver's steering.

### Detecting sensor

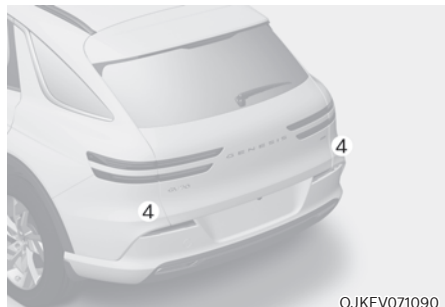

- [1]: Front view camera,
- [2]: Front radar,
- [3]: Front corner radar (if equipped),
- [4]: Rear corner radar (if equipped)

Refer to the picture above for the detailed location of the detecting sensors.



## CAUTION

Take the following precautions to maintain optimal performance of the detecting sensor:

- Never disassemble the detecting sensor or sensor assembly, or cause any damage to it.
  - If the detecting sensors have been replaced or repaired, we recommend that you have your vehicle inspected by an authorized retailer of Genesis Branded products.
  - Never install any accessories or stickers on the front windshield, or tint the front windshield.
  - Exercise extreme caution to keep the front view camera dry.
  - Never place any reflective objects (for example, white paper, mirror) over the dashboard.
  - Do not place any objects near the front windshield or install any accessories on the front windshield. It can affect the performance of the defogging and defrosting function of the climate control system, which may prevent the Driver Assistance systems from operating.
  - Do not apply license plate frame or objects, such as a bumper sticker, film or a bumper guard, near the front radar cover.
  - Do not change the position of the license plate. The front radar's detection and control performance may be affected.
  - Always keep the front radar and cover clean and free of dirt and debris.  
Use only a soft cloth to wash the vehicle. Do not spray pressurized water directly on the sensor or sensor cover.
- If the radar or the area around the radar has been damaged or impacted in any way, Forward Collision-Avoidance Assist may not properly operate even though a warning message does not appear on the cluster. We recommend that the vehicle be inspected by an authorized retailer of Genesis Branded products.
  - Use only genuine parts to repair or replace a damaged front radar cover. Do not apply paint to the front radar cover.
  - Vehicles equipped with front corner radar and/or rear corner radar
    - Do not apply license plate frame or objects, such as a bumper sticker, film or a bumper guard, near the front corner radar or rear corner radar.
    - The function may not work properly when the bumper has been replaced, or the surroundings of the front corner radar or rear corner radar has been damaged or paint has been applied.
    - If a trailer, carrier, etc., is installed, it may adversely affect the performance of the rear corner radar or Forward Collision-Avoidance Assist may not operate properly.

## Forward Collision-Avoidance Assist settings

### Forward safety

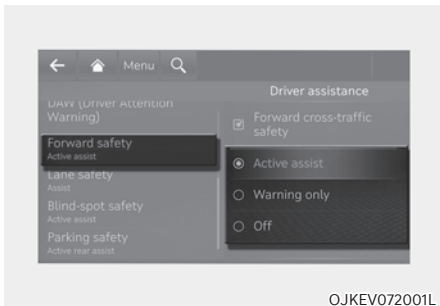

With the vehicle on, select or deselect 'Driver assistance → Forward safety' from the Settings menu to set whether to use each function.

- If 'Active assist' is selected, Forward Collision-Avoidance Assist will warn the driver with a warning message, an audible warning and steering wheel vibration depending on the collision risk levels. Braking assist or steering assist (if equipped) will be applied depending on the collision risk levels.
- If 'Warning only' is selected, Forward Collision-Avoidance Assist will warn the driver with a warning message, an audible warning and steering wheel vibration depending on the collision risk levels. Braking and steering (if equipped) will not be assisted. The driver must apply the brake pedal or steer the vehicle if necessary.
- If 'Off' is selected, Forward Collision-Avoidance Assist will turn off. The warning light  will illuminate on the cluster.

The driver can monitor Forward Collision-Avoidance Assist On/Off status from the Settings menu. If the warning light  remains ON when Forward Collision-Avoidance Assist is on, we recommend that the vehicle be inspected by an authorized retailer of Genesis Branded products.

### Forward cross-traffic safety (if equipped)

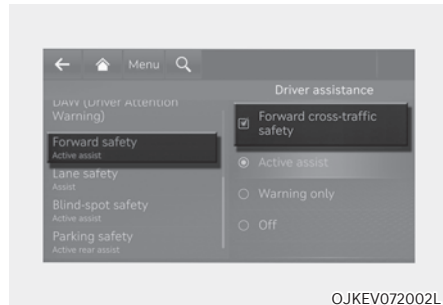

With the vehicle on, select 'Driver assistance → Forward safety → Forward cross-traffic safety' from the Settings menu to turn on Junction Crossing function and deselect to turn off the function.

### WARNING

**When the vehicle is restarted, Forward Collision-Avoidance Assist will always turn on. However, if 'Off' is selected, the driver should always be aware of the surroundings and drive safely.**





## CAUTION

- If 'Warning only' is selected, braking or steering (if equipped) is not assisted.
- The settings for Forward safety include 'Basic function', 'Junction Turning', 'Lane-Change Oncoming', 'Lane-Change Side' and 'Evasive Steering Assist' (if equipped).
- If Forward safety is set to 'Off', Junction Crossing function will not operate even when 'Forward Cross-Traffic Safety' (if equipped) is selected.



## Information

Forward Collision-Avoidance Assist will turn off when ESC is turned off by pressing and holding the ESC OFF button. The  warning light will illuminate on the cluster.

## Warning timing

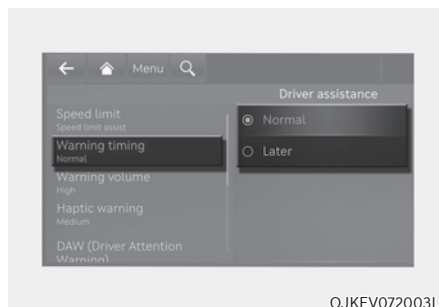

With the vehicle on, select 'Driver assistance → Warning timing' from the Settings menu to change the initial warning activation time for Forward Collision-Avoidance Assist. The warning time can be set to either 'Normal (Standard)' or 'Later'.

- Use 'Normal (Standard)' in normal driving conditions. If the Warning timing seems sensitive, change it to 'Later'.
- If 'Later' is selected, Forward Collision-Avoidance Assist, warns the driver more slowly.



## Information

**If you change the Warning timing, the Warning Timing of other Driver Assistance systems may change.**

### Warning volume

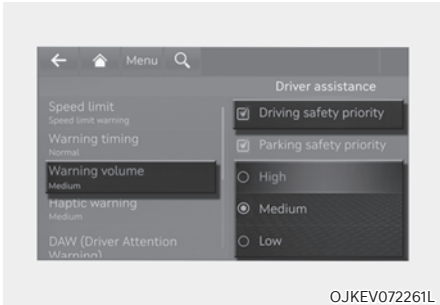

With the vehicle on, select 'Driver assistance → Warning volume' or 'Sound → Driver assistance → Warning volume' from the Settings menu to change the Warning volume to 'High', 'Medium', 'Low' or 'Off' for Forward Collision-Avoidance Assist.

If 'Driving safety priority' is selected, the vehicle lowers all other audio volumes when the warning sounds for safe driving.

### Information

- If the vehicle is restarted, Warning timing and Warning volume will maintain the last setting.
- If 'Off' is selected, the Warning volume of Forward Collision-Avoidance Assist will not turn off, but the volume will sound as 'Low'.
- If you change the Warning volume, the Warning volume of other Driver Assistance systems may change.
- If 'Off' is selected, steering wheel vibration will not turn off.
- Select 'Driver Assistance → Haptic Warning' from the Settings menu to change the steering wheel vibration intensity to 'Strong', 'Medium', 'Light' or 'Off'.

### CAUTION

- The setting of the Warning timing and Warning volume applies to all functions of Forward Collision-Avoidance Assist.
- Even though 'Normal (Standard)' is selected for Warning timing, if a detected vehicle in front suddenly stops, the warning may seem late.
- Select 'Later' for Warning timing when traffic is light and when driving speed is slow.

## Forward Collision-Avoidance Assist operation

### Basic function

The basic function for Forward Collision-Avoidance Assist is to warn and help control the vehicle depending on the collision risk level: 'Collision Warning', 'Emergency Braking' and 'Stopping vehicle and ending brake control'.

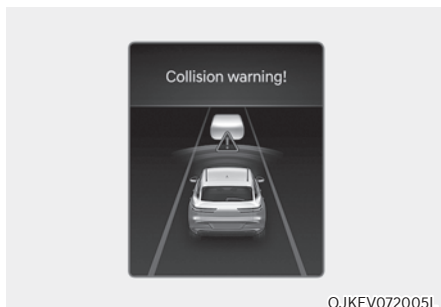

### Collision warning

- To warn the driver of a collision, the 'Collision warning!' warning message will appear on the cluster, an audible warning will sound and the steering wheel will vibrate.
- If a vehicle is detected in front, the function will operate when your vehicle speed is between approximately 10-200 km/h (6-124 mph).
- If a pedestrian or cyclist is detected in front, the function will operate when your vehicle speed is between approximately 10-85 km/h (6-53 mph).

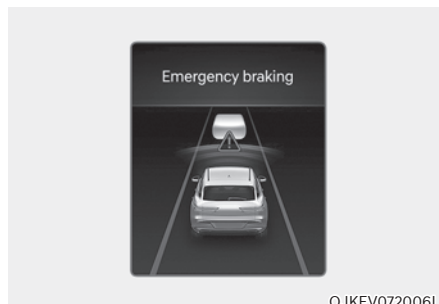

### Emergency braking

- To warn the driver that emergency braking will be assisted, the 'Emergency braking' warning message will appear on the cluster, an audible warning will sound and the steering wheel will vibrate.

Emergency braking will operate under the following conditions.

- Vehicle:

	Driving vehicle	Stopped vehicle
Weak braking power	Approximately 10-200 km/h (6-125 mph) *	
Strong braking power	Approximately 10-130 km/h (6-81 mph) *	Approximately 10-75 km/h (6-47 mph) (10-100 km/h (6-62 mph))*

\*: If Forward Collision-Avoidance Assist judges that avoiding a collision is difficult even by changing the driving lane. The function operate range may decrease due to surroundings of the vehicle. (if equipped)

- Pedestrian or cyclist: The function will operate when your vehicle speed is between approximately 10-65 km/h (6-40 mph).



**Stopping vehicle and ending brake control**

- When the vehicle is stopped due to emergency braking, the 'Drive carefully' warning message will appear on the cluster.  
For your safety, the driver should depress the brake pedal immediately and check the surroundings.
- Brake control will end after the vehicle is stopped by emergency braking for approximately 2 seconds.

**Junction Turning function**

Junction Turning function will warn and control the vehicle depending on the collision risk level: 'Collision Warning', 'Emergency Braking' and 'Stopping vehicle and ending brake control'.

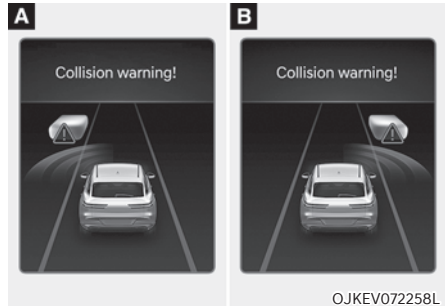

[A]: Left-hand drive, [B]: Right-hand drive

**Collision warning**

- To warn the driver of a collision, the 'Collision warning!' warning message will appear on the cluster, an audible warning will sound and the steering wheel will vibrate.
- The function will operate when your vehicle speed is between approximately 10-30 km/h (6-19 mph) and the oncoming vehicle speed is between approximately 30-70 km/h (19-44 mph).

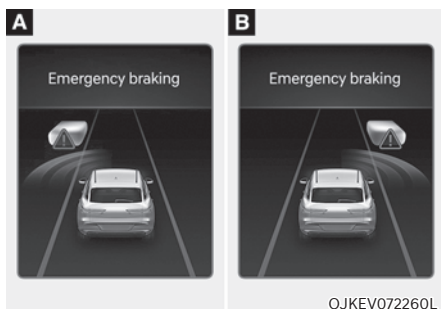

[A]: Left-hand drive, [B]: Right-hand drive

### Emergency braking

- To warn the driver that emergency braking will be assisted, the 'Emergency braking' warning message will appear on the cluster, an audible warning will sound and the steering wheel will vibrate.
- In emergency braking situation, braking is assisted with strong braking power by the function to help prevent collision with the oncoming vehicle.
- The function will operate when your vehicle speed is between approximately 10-30 km/h (6-19 mph) and the oncoming vehicle speed is between approximately 30-70 km/h (19-44 mph).

### **i** Information

**If the driver's seat is on the left side, Junction Turning function will operate only when you turn left. If the driver's seat position is on the right side, the function will operate only when you turn right.**

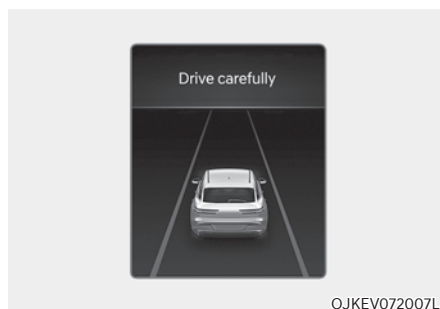

### Stopping vehicle and ending brake control

- When the vehicle is stopped due to emergency braking, the 'Drive carefully' warning message will appear on the cluster.  
For your safety, the driver should depress the brake pedal immediately and check the surroundings.
- Brake control will end after the vehicle is stopped by emergency braking for approximately 2 seconds.

### Junction Crossing function (if equipped)

Junction Crossing function will warn and control the vehicle depending on collision risk level: 'Collision Warning', 'Emergency Braking' and 'Stopping vehicle and ending brake control'

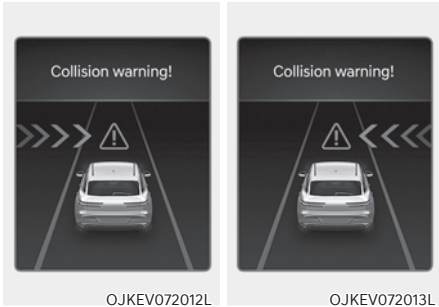

#### Collision warning

- To warn the driver of a collision, the 'Collision warning!' warning message will appear on the cluster, an audible warning will sound and the steering wheel will vibrate.
- The function will operate when your vehicle speed is between approximately 10-30 km/h (6-19 mph) and the crossing vehicle speed is between approximately 10-60 km/h (6-37 mph).

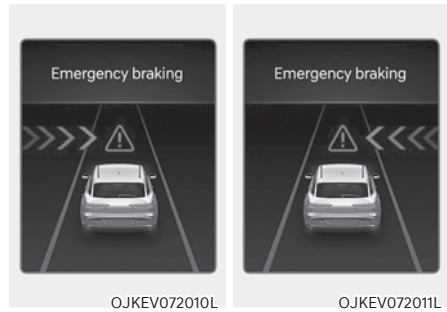

#### Emergency braking

- To warn the driver that emergency braking will be assisted, the 'Emergency braking' warning message will appear on the cluster, an audible warning will sound and the steering wheel will vibrate.
- In emergency braking situation, braking is assisted with strong braking power by the function to help prevent collision with the crossing vehicle.
- The function will operate when your vehicle speed is between approximately 10-30 km/h (6-19 mph) and the crossing vehicle speed is between approximately 10-20 km/h (6-12 mph).

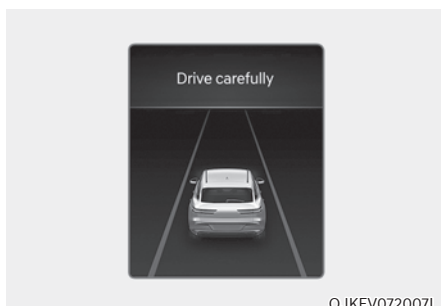

OJKEV072007L

### Stopping vehicle and ending brake control

- When the vehicle is stopped due to emergency braking, the 'Drive carefully' warning message will appear on the cluster.  
For your safety, the driver should depress the brake pedal immediately and check the surroundings.
- Brake control will end after the vehicle is stopped by emergency braking for approximately 2 seconds.



### CAUTION

**If the collision angle with the crossing vehicle is beyond a certain range, Junction Crossing function warning and control may be late or may not operate.**

### Lane-Change Oncoming function (if equipped)

Lane-Change Oncoming function will warn and control the vehicle depending on collision risk level: 'Collision Warning' and 'Emergency Steering'

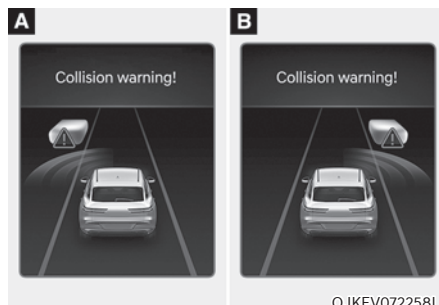

OJKEV072258L

[A]: Left-hand drive, [B]: Right-hand drive

### Collision warning

- To warn the driver of a collision, the 'Collision warning!' warning message will appear on the cluster, an audible warning will sound and the steering wheel will vibrate.
- The function will operate when your vehicle speed is between approximately 40-145 km/h (25-90 mph) and the oncoming vehicle speed is approximately above 10 km/h (6 mph) and the relative speed with your vehicle is approximately below 200 km/h (124 mph).

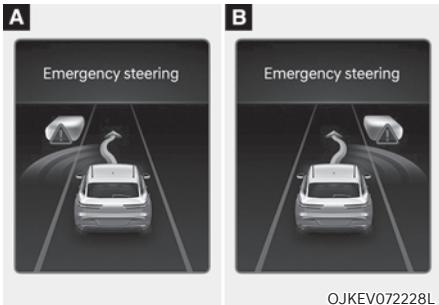

[A]: Left-hand drive, [B]: Right-hand drive

### Emergency steering

- To warn the driver that emergency steering will be assisted, the 'Emergency steering' warning message will appear on the cluster, an audible warning will sound and the steering wheel will vibrate.
- In an emergency steering situation, steering is assisted by the function to help prevent a collision with the oncoming vehicle.
- The function will operate when your vehicle speed is between approximately 40-145 km/h (25-90 mph) and the oncoming vehicle speed is approximately above 10 km/h (6 mph) and the relative speed with your vehicle is approximately below 200 km/h (124 mph).

### Lane-Change Side function (if equipped)

Lane-Change Side function will warn and control the vehicle depending on collision risk level: 'Collision Warning' and 'Emergency Steering'



### Collision warning

- To warn the driver of a collision, the 'Collision warning!' warning message will appear on the cluster, an audible warning will sound and the steering wheel will vibrate.
- The function will operate when your vehicle speed is between approximately 40-145 km/h (25-90 mph).





### Emergency steering

- To warn the driver that emergency steering will be assisted, the 'Emergency steering' warning message will appear on the cluster, an audible warning will sound and the steering wheel will vibrate.
- In emergency steering situation, steering is assisted by the function to help prevent collision with the front-side vehicle.
- The function will operate when your vehicle speed is between approximately 40-145 km/h (25-90 mph) and front-side vehicle is driving.



### CAUTION

**Lane-Change Side function does not operate if the vehicle speed of the preceding vehicle from the front side is 0 km/h (0 mph).**

### *Evasive Steering Assist function (if equipped)*

Evasive Steering Assist function will warn and control the vehicle with 'Emergency steering'.

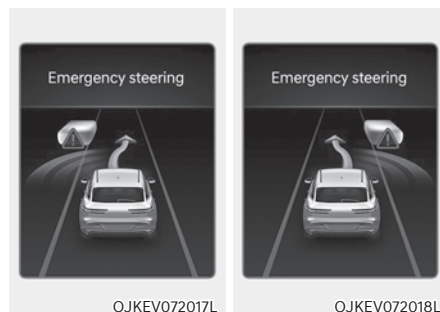

### Emergency steering (Driver steering assist)

- To warn the driver that emergency steering will be assisted, the 'Emergency steering' message will appear on the cluster, an audible warning will sound and the steering wheel will vibrate.
- If there is a risk of collision with a vehicle, pedestrian and cyclist in front, the steering will be assisted to help prevent collision when the driver steers the vehicle to avoid collision.
- The function will operate when your vehicle speed is between approximately 40-85 km/h (25-53 mph).

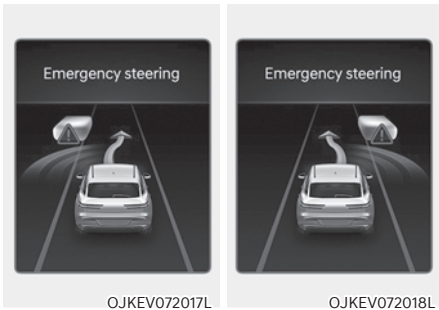

**Emergency steering (Evasive steering assist)**

- To warn the driver that emergency steering will be assisted, the ‘Emergency steering’ message will appear on the cluster, an audible warning will sound and the steering wheel will vibrate.
- If there is high risk of collision with a pedestrian and cyclist in front, and the vehicle speed to operate emergency braking is within the operation range, the steering will be assisted to help prevent collision when there is space to avoid collision in the driving lane.
- The function will operate when your vehicle speed is between approximately 65-75 km/h (40-47 mph).



**CAUTION**

- The steering wheel may turn automatically when emergency steering is operating.
- Emergency steering will automatically cancel when risk factors disappear. If necessary, the driver must steer the vehicle.
- Emergency steering may not operate or may cancel during operation if the steering wheel is held tight or steered in the opposite direction.
- When steering is assisted to avoid collision with a vehicle, pedestrian and cyclist, evasive steering assist will be cancelled if collisions with other objects (vehicles, pedestrians, or cyclists) are expected.
- Evasive steering assist may not operate if space to avoid collision in the driving lane is insufficient.



**Information**

For more details on warning messages, refer to Collision Warning in “Basic Function”.

**WARNING**

Take the following precautions when using Forward Collision-Avoidance Assist:

- For your safety, only change the Settings after parking the vehicle at a safe location.
- With 'Active Assist' or 'Warning only' selected, when ESC is turned off by pressing and holding the ESC OFF button, Forward Collision-Avoidance Assist will turn off automatically. In this case, Forward Collision-Avoidance Assist cannot be set from the Settings menu and the warning light will illuminate on the cluster which is normal. If ESC is turned on by pressing the ESC OFF button, Forward Collision-Avoidance Assist will maintain the last setting.
- Forward Collision-Avoidance Assist does not operate in all situations and cannot avoid all collisions.
- The driver has the responsibility to control the vehicle. Do not solely depend on Forward Collision-Avoidance Assist. Rather, maintain a safe braking distance, and if necessary, depress the brake pedal to reduce driving speed or to stop the vehicle.
- Never deliberately operate Forward Collision-Avoidance Assist on people, objects, etc. It may cause serious injury or death.
- Forward Collision-Avoidance Assist may not operate if the driver depresses the brake pedal to avoid collision.
- Depending on the road and driving conditions, Forward Collision-Avoidance Assist may warn the driver late or may not warn the driver.
- During Forward Collision-Avoidance Assist operation, the vehicle may stop suddenly injuring passengers and shifting loose objects. Always have the seat belt on and keep loose objects secured.
- If any other system's warning message is displayed or audible warning is generated, Forward Collision-Avoidance Assist warning message may not be displayed and audible warning may not be generated.
- You may not hear the warning sound of Forward Collision-Avoidance Assist if the surrounding is noisy.
- Forward Collision-Avoidance Assist may turn off or may not operate properly or may operate unnecessarily depending on the road conditions and the surroundings.

**WARNING**

- Even if there is a problem with Forward Collision-Avoidance Assist, the vehicle's basic braking performance will operate properly.
- During emergency braking, braking control by Forward Collision-Avoidance Assist will automatically cancel when the driver excessively depresses the accelerator pedal or sharply steers the vehicle.



### CAUTION

- Depending on the condition of the vehicle, pedestrian and cyclist in front and the surroundings, the speed range to operate Forward Collision-Avoidance Assist may reduce. Forward Collision-Avoidance Assist may only warn the driver, or it may not operate.
- Forward Collision-Avoidance Assist will operate under certain conditions by judging the risk level based on the condition of the oncoming vehicle, driving direction, speed and surroundings.
- Only Forward Collision-Avoidance Assist warning and collision mitigation are possible depending on the detectable distance.
- When a collision with a surrounding vehicle is expected, Lane-Change Oncoming, Lane-Change Side and Evasive Steering Assist will not assist you with steering but only warn you of a collision (if equipped).





### Information

- In a situation where collision is imminent, braking may be assisted by Forward Collision-Avoidance Assist when braking is insufficient by the driver.
- The images and colors in the instrument cluster may differ depending on the cluster type or theme selected from the settings menu.

## Forward Collision-Avoidance Assist malfunction and limitations

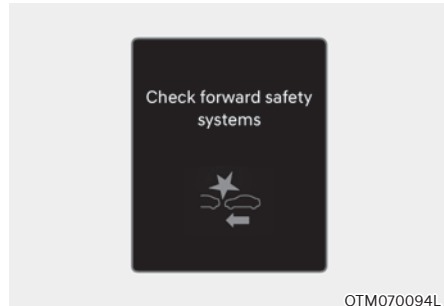
### *Forward Collision-Avoidance Assist malfunction*



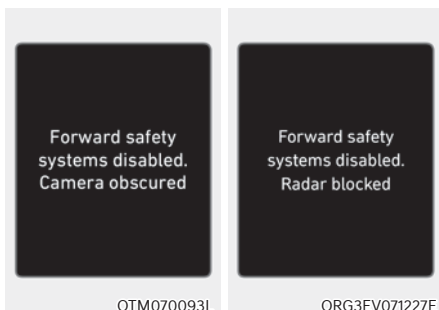

When Forward Collision-Avoidance Assist is not working properly, the 'Check Forward safety system' warning message will appear, and the  and  warning lights will illuminate on the cluster. We recommend that the vehicle be inspected by an authorized retailer of Genesis Branded products.

### Forward Collision-Avoidance Assist disabled



When the front windshield where the front view camera is located, front radar cover, bumper or sensor is covered with foreign material, such as snow or rain, it can reduce the detecting performance and temporarily limit or disable Forward Collision-Avoidance Assist.

If this occurs the 'Forward safety system(s) disabled. Camera obscured' or the 'Forward safety system(s) disabled. Radar blocked' warning message, and the  and  warning lights will illuminate on the cluster.

Forward Collision-Avoidance Assist will operate properly when snow, rain or foreign material is removed.

If Forward Collision-Avoidance Assist does not operate properly after obstruction (snow, rain, or foreign material) is removed (including trailer, carrier, etc., from the rear bumper), we recommend that the vehicle be inspected by an authorized retailer of Genesis Branded products.



### WARNING

- Even though the warning message or warning light does not appear on the cluster, Forward Collision-Avoidance Assist may not properly operate.
- Forward Collision-Avoidance Assist may not properly operate in an area (for example, open terrain), where any objects are not detected after turning ON the vehicle.

### Limitations of Forward Collision-Avoidance Assist

Forward Collision-Avoidance Assist may not operate properly, or it may operate unexpectedly under the following circumstances:

- The detecting sensor or the surroundings are contaminated or damaged
- The temperature around the front view camera is high or low due to surrounding environment
- The camera lens is contaminated due to tinted, filmed or coated windshield, damaged glass, or sticky foreign material (sticker, bug, etc.) on the glass
- Moisture is not removed or frozen on the windshield
- Washer fluid is continuously sprayed, or the wiper is on
- Driving in heavy rain or snow, or thick fog
- The field of view of the front view camera is obstructed by sun glare
- Street light or light from an oncoming traffic is reflected on the wet road surface, such as a puddle on the road
- An object is placed on the dashboard
- Your vehicle is being towed
- The surrounding is very bright

- The surrounding is very dark, such as in a tunnel, etc.
- The brightness changes suddenly, for example when entering or exiting a tunnel
- The brightness outside is low, and the headlamps are not on or are not bright
- Driving through steam, smoke or shadow
- Only part of the vehicle, pedestrian or cyclist is detected
- The vehicle in front is a bus, heavy truck, truck with an unusually shaped cargo, trailer, etc.
- The vehicle in front has no tail lights, tail lights are located unusually, etc.
- The brightness outside is low, and the tail lamps are not on or are not bright
- The rear of the front vehicle is small or the vehicle does not look normal, such as when the vehicle is tilted, overturned, or the side of the vehicle is visible, etc.
- The front vehicle's ground clearance is low or high
- A vehicle, pedestrian or cyclist suddenly cuts in front
- The bumper around the front radar is impacted, damaged or the front radar is out of position
- The temperature around the front radar is high or low
- Driving through a tunnel or iron bridge
- Driving in vast areas where there are few vehicles or structures (for example, desert, meadow, suburb, etc.)
- Driving near areas containing metal substances, such as a construction zone, railroad, etc.
- A material is near that reflects very well on the front radar, such as a guardrail, nearby vehicle, etc.
- The cyclist in front is on a bicycle made of material that does not reflect on the front radar
- The vehicle in front is detected late
- The vehicle in front is suddenly blocked by an obstacle
- The vehicle in front suddenly changes lane or suddenly reduces speed
- The vehicle in front is bent out of shape
- The front vehicle speed is fast or slow
- The vehicle in front steers in the opposite direction of your vehicle to avoid a collision
- With a vehicle in front, your vehicle changes lane at low speed
- The vehicle in front is covered with snow
- You are departing or returning to the lane
- Unstable driving
- You are on a roundabout and the vehicle in front is not detected
- You are continuously driving in a circle
- The vehicle in front has an unusual shape
- The vehicle in front is driving uphill or downhill
- The pedestrian or cyclist is not fully detected, for example, if the pedestrian is leaning over or is not fully walking upright
- The pedestrian or cyclist is wearing clothing or equipment that makes it difficult to detect



The illustration above shows the image the front view camera and front radar are capable of detecting as a vehicle, pedestrian and cyclist.

- The pedestrian or cyclist in front is moving very quickly
- The pedestrian or cyclist in front is short or is posing a low posture
- The pedestrian or cyclist in front has impaired mobility
- The pedestrian or cyclist in front is moving intersected with the driving direction
- There is a group of pedestrians, cyclists or a large crowd in front
- The pedestrian or cyclist is wearing clothing that easily blends into the background, making it difficult to detect
- The pedestrian or cyclist is difficult to distinguish from the similarly shaped structure in the surroundings
- You are driving by a pedestrian, cyclist, traffic signs, structures, etc., near the intersection
- Driving in a parking lot
- Driving through a tollgate, construction area, unpaved road, partial paved road, uneven road, speed bumps, etc.

- Driving on an incline road, curved road, etc.
- Driving through a roadside with trees or streetlights
- The adverse road conditions cause excessive vehicle vibrations while driving
- Your vehicle height is low or high due to heavy loads, abnormal tire pressure, etc.
- Driving through a narrow road where trees or grass are overgrown
- There is interference by electromagnetic waves, such as driving in an area with strong radio waves or electrical noise

#### **Junction Crossing, Lane-Change Oncoming, Lane-Change Side, Evasive Steering Assist function (if equipped)**

- The temperature around the front corner radar or rear corner radar is high or low
- A trailer or carrier is installed around the rear corner radar
- The front corner radar or rear corner radar is covered with snow, rain, dirt, etc.
- The bumper around the front corner radar or rear corner radar is covered with objects, such as a bumper sticker, bumper guard, bike rack, etc.
- The bumper around the front corner radar or rear corner radar is impacted, damaged or the radar is out of position
- The front corner radar or rear corner radar is blocked by other vehicles, walls or pillars

- Driving on a highway (or motorway) ramp or driving through a tollgate
- Driving on a road where the guardrail or wall is in double structure
- The other vehicle drives very close behind your vehicle, or the other vehicle passes by your vehicle in close proximity
- The speed of the other vehicle is very fast that it passes by your vehicle in a short time
- Your vehicle passes by the other vehicle
- Your vehicle has started at the same time as the vehicle next to you and has accelerated
- The vehicle in the next lane moves two lanes away from you, or when the vehicle two lanes away moves to the next lane from you
- A motorcycle or bicycle is detected
- A vehicle such as a flat trailer is detected
- A big vehicle such as a bus or truck is detected
- A small moving obstacle such as a pedestrian, animal, shopping cart or a baby stroller is detected
- A vehicle with low height such as a sports car is detected
- The lane is difficult to see due to foreign material, such as rain, snow, dust, sand, oil and water puddles
- The color of the lane marking is not distinguishable from the road
- There are markings on the road near the lane or the markings on the road looks similar to the lane markings
- The shadow is on the lane marking by a median strip, trees, guardrail, noise barriers, etc.
- The lane number increases or decreases, or the lane markings are crossing
- There are more than two lane markings on the road
- The lane markings are complicated or a structure substitutes for the lines, such as a construction area
- There are road markings, such as zigzag lanes, crosswalk markings and road signs
- The lane suddenly disappears, such as at the intersection
- The lane is very wide or narrow
- There is a curb or road edges without a lane
- The vehicle in front is driving with one side on the lane marking
- The distance to the front vehicle is extremely short



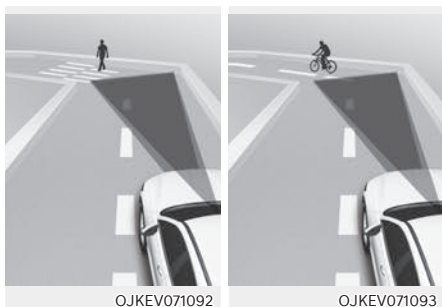

**WARNING**

- Driving on a curved road

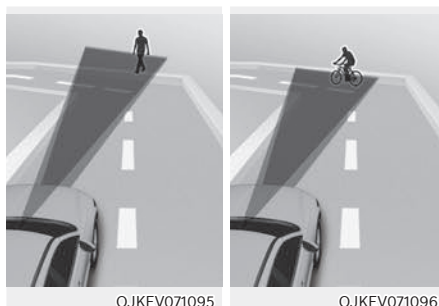

**Forward Collision-Avoidance Assist may not detect other vehicles, pedestrians or cyclists in front of you when driving on curved roads adversely affecting the performance of the sensors. This may result in no warning, braking assist or steering assist (if equipped) when necessary.**

**When driving on a curve, you must maintain a safe braking distance, and if necessary, steer the vehicle and depress the brake pedal to reduce your driving speed in order to maintain a safe distance.**



**Forward Collision-Avoidance Assist may detect a vehicle, pedestrian or cyclist in the next lane or outside the lane when driving on a curved road.**

**If this occurs, Forward Collision-Avoidance Assist may unnecessarily warn the driver and control the brake or steering wheel (if equipped). Always check the traffic conditions around the vehicle.**

- **Driving on an inclined road**



**Forward Collision-Avoidance Assist may not detect other vehicles, pedestrians or cyclists in front of you while driving uphill or downhill, adversely affecting the performance of the sensors.**

**This may result in unnecessary warning, braking assist or steering assist (if equipped) or no warning, braking assist or steering assist (if equipped) when necessary.**

**Also, vehicle speed may rapidly decrease when a vehicle, pedestrian or cyclist ahead is suddenly detected.**

**Always have your eyes on the road while driving uphill or downhill and if necessary, steer your vehicle and depress the brake pedal to reduce your driving speed in order to maintain a safe distance.**

- Changing lanes



[A]: Your vehicle,  
[B]: Lane changing vehicle

**When a vehicle moves into your lane from an adjacent lane, it cannot be detected by the sensor until it is in the sensor's detection range. Forward Collision-Avoidance Assist may not immediately detect the vehicle when the vehicle changes lanes abruptly. In this case, you must maintain a safe braking distance, and if necessary, steer your vehicle and depress the brake pedal to reduce your driving speed in order to maintain a safe distance.**



[A]: Your vehicle,  
[B]: Lane changing vehicle,  
[C]: Same lane vehicle

**When a vehicle in front of you merges out of the lane, Forward Collision-Avoidance Assist may not immediately detect the vehicle that is now in front of you. In this case, you must maintain a safe braking distance, and if necessary, steer your vehicle and depress the brake pedal to reduce your driving speed in order to maintain a safe distance.**

- **Detecting vehicle**

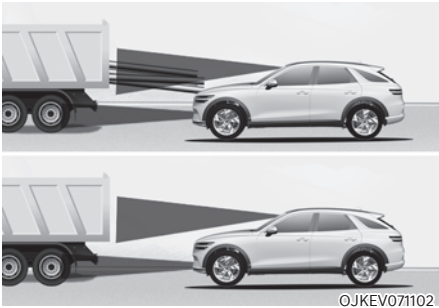

If the vehicle in front of you has cargo that extends rearward from the cab, or when the vehicle in front of you has higher ground clearance, additional special attention is required. Forward Collision-Avoidance Assist may not be able to detect the cargo extending from the vehicle. In these instances, you must maintain a safe braking distance from the rearmost object, and if necessary, steer your vehicle and depress the brake pedal to reduce your driving speed in order to maintain distance.

 **WARNING**

- When you are towing a trailer or another vehicle, turn off Forward Collision-Avoidance Assist for safety reasons.
- Forward Collision-Avoidance Assist may operate if objects that are similar in shape or characteristics to vehicles, pedestrians and cyclists are detected.
- Forward Collision-Avoidance Assist does not operate on bicycles, or smaller wheeled objects, such as luggage bags, shopping carts, or strollers.
- Forward Collision-Avoidance Assist may not operate properly if interfered by strong electromagnetic waves.
- Forward Collision-Avoidance Assist may not operate for 15 seconds after the vehicle is started, or the front view camera is initialized.

## LANE KEEPING ASSIST (LKA) (IF EQUIPPED)

Lane Keeping Assist is designed to help detect lane markings (or road edges) while driving over a certain speed. Lane Keeping Assist will warn the driver if the vehicle leaves the lane without using the turn signal, or will automatically assist the driver's steering to help prevent the vehicle from departing the lane.

### Detecting sensor



OJKEV051076

[1]: Front view camera

The front view camera is used as a detecting sensor to detect lane markings (or road edges).

Refer to the picture above for the detailed location of the detecting sensor.

### CAUTION

For more details on the precautions of the front view camera, refer to “Forward Collision-Avoidance Assist (FCA)” section in this chapter.

## Lane Keeping Assist settings

### Lane safety

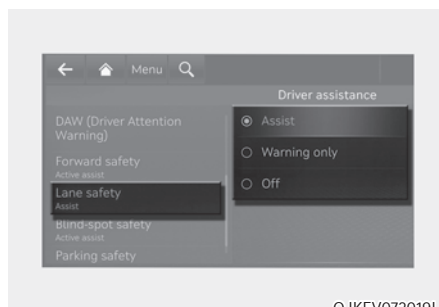

OJKEV072019L

With the vehicle on, select or deselect ‘Driver assistance → Lane safety’ from the Settings menu to set whether to use each function.

- If ‘Assist’ is selected, Lane Keeping Assist will automatically assist the driver’s steering when lane departure is detected to help prevent the vehicle from moving out of its lane.
- If ‘Warning only’ is selected, Lane Keeping Assist will warn the driver with an audible warning and steering wheel vibration when lane departure is detected. The driver must steer the vehicle.
- If ‘Off’ is selected, Lane Keeping Assist will turn off. The  indicator light will turn off on the cluster.

### WARNING

- If ‘Warning only’ is selected, steering is not assisted.
- Lane Keeping Assist does not control the steering wheel when the vehicle is driven in the middle of the lane.
- The driver should always be aware of the surroundings and steer the vehicle if ‘Off’ is selected.

### Warning volume

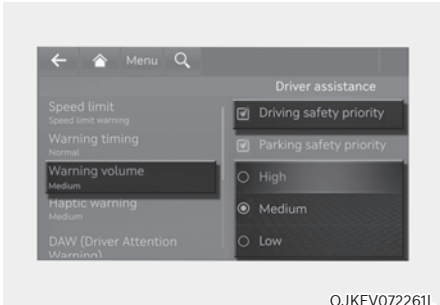



With the vehicle on, select 'Driver assistance → Warning volume' or 'Sound → Driver assistance → Warning volume' from the Settings menu to change the Warning volume to 'High', 'Medium', 'Low' or 'Off' for Lane Keeping Assist. If 'Driving safety priority' is selected, the vehicle lowers all other audio volumes when the warning sounds for safe driving.

#### **i** Information

- If you change the Warning volume, the Warning volume of other Driver Assistance systems may change.
- If 'Off' is selected, steering wheel vibration will not turn off.

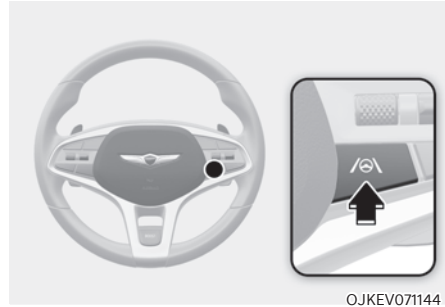
### Lane Keeping Assist operation Turning Lane Keeping Assist On/Off



- For Europe  
Whenever the vehicle is turned on, Lane Keeping Assist will always turn on. The grey  indicator light will illuminate on the cluster.  
When Lane Keeping Assist is on, press and hold the Lane Driving Assist button to turn off the function.

#### **i** Information

When the Lane Driving Assist button is pressed shortly, Lane Following Assist will turn on and off.

Lane Keeping Assist will warn and help control the vehicle with Lane Departure Warning and Lane Keeping Assist.

### Warning and control

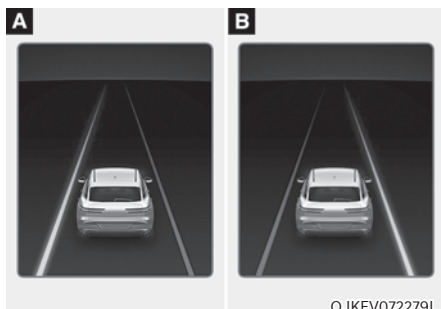

[A]: Left, [B]: Right

### Lane Departure Warning

- To warn the driver that the vehicle is departing from the projected lane in front, the green  indicator light will blink on the cluster, the lane line will blink on the cluster depending on which direction the vehicle is veering, and an audible warning will sound. Also, the steering wheel will vibrate.
- Lane Keeping Assist will operate when your vehicle speed is between approximately 60-200 km/h (40-120 mph).

### Lane Keeping Assist

- To warn the driver that the vehicle is departing from the projected lane in front, the green  indicator light will blink on the cluster, and the steering wheel will make adjustments to keep vehicle inside the lane.
- Lane Keeping Assist will operate when your vehicle speed is between approximately 60-200 km/h (40-120 mph).

### Hands-off warning

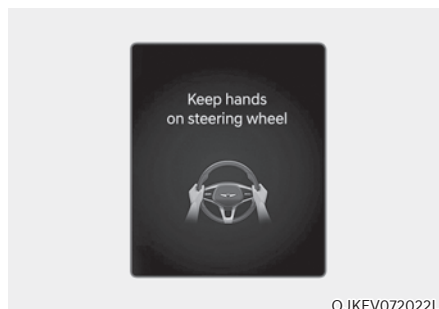

If the driver takes their hands off the steering wheel for several seconds, the 'Keep hands on steering wheel' warning message will appear on the cluster, and an audible warning will sound in stages.

**⚠ WARNING**

- The steering wheel may not be assisted if the steering wheel is held very tight or the steering wheel is steered over a certain degree.
- Lane Keeping Assist does not operate at all times. It is the responsibility of the driver to safely steer the vehicle and to maintain the vehicle in its lane.
- The hands-off warning message may appear late depending on road conditions. Always have your hands on the steering wheel while driving.
- If the steering wheel is held very lightly, the hands-off warning message may appear because Lane Keeping Assist may not recognize that the driver has their hands on the steering wheel.
- If you attach objects to the steering wheel, the hands-off warning may not work properly.

**i Information**

- For more details on instrument cluster settings, refer to “LCD display control” section in chapter 4.
- When lane markings (or road edges) are detected, the lane lines on the cluster will change from grey to white and the green  indicator light will illuminate.
- When the lane markings (or road edges) are detected and Highway Lane Change Assist is on, the lane lines on the cluster may change to green.

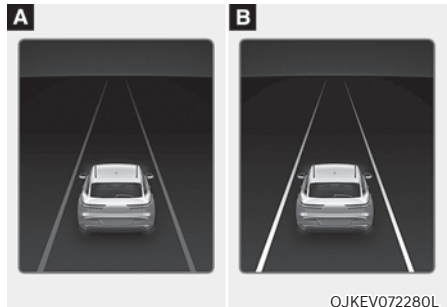

[A]: Lane undetected, [B]: Lane detected

- The images and colors in the instrument cluster may differ depending on the cluster type or theme selected from the settings menu.
- Even though the steering is assisted by Lane Keeping Assist, the driver may control the steering wheel.
- The steering wheel may feel heavier or lighter when the steering wheel is assisted by Lane Keeping Assist than when it is not.



## Lane Keeping Assist malfunction and limitations

### Lane Keeping Assist malfunction

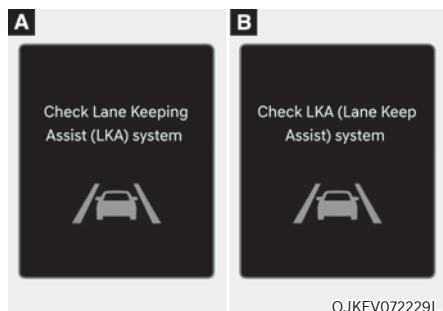

When Lane Keeping Assist is not working properly, the 'Check Lane Keeping Assist (LKA) systems' (or 'Check LKA (Lane Keep Assist) system') warning message will appear and the yellow  indicator light will illuminate on the cluster. If this occurs, we recommend that the vehicle be inspected by an authorized retailer of Genesis Branded products.

### Limitations of Lane Keeping Assist

Lane Keeping Assist may not operate properly or may operate unexpectedly under the following circumstances:

- The lane is contaminated or difficult to detect because:
  - The lane markings (or road edge) are covered with rain, snow, dirt, oil, etc.
  - The color of the lane marking (or road edge) is not distinguishable from the road

- There are markings (or road edges) on the road near the lane or the markings (or road edges) on the road look similar to the lane markings (or road edge)
- The lane marking (or road edge) is indistinct or damaged
- The shadow is on the lane marking (or road edge) by a median strip, trees, guardrail, noise barriers, etc.
- The lane number increases or decreases, or the lane markings (or road edges) are crossing
- There are more than two lane markings (or road edges) on the road
- The lane markings (or road edges) are complicated or a structure substitutes for the lines, such as a construction area
- There are road markings, such as zigzag lanes, crosswalk markings and road signs
- The lane suddenly disappears, such as at the intersection
- The lane (or road width) is very wide or narrow
- There is a road edge without a lane
- There is a boundary structure in the roadway, such as a tollgate, sidewalk, curb, etc.
- The distance to the front vehicle is extremely short or the vehicle in front is covering the lane marking (or road edge)

### Information

For more details on the limitations of the front view camera, refer to "Forward Collision-Avoidance Assist (FCA)" section in this chapter.



## **WARNING**

Take the following precautions when using Lane Keeping Assist:

- The driver has the responsibility to safely drive and control the vehicle. Do not solely rely on Lane Keeping Assist and drive dangerously.
  - The operation of Lane Keeping Assist can be cancelled or not work properly depending on road conditions and surroundings. Always be cautious while driving.
  - Refer to “Limitations of Lane Keeping Assist” if the lane is not detected properly.
  - When you are towing a trailer or another vehicle, turn off Lane Keeping Assist for safety reasons.
  - If the vehicle is driven at high speed, the steering wheel will not be controlled. The driver must always follow the speed limit when using Lane Keeping Assist.
  - If any other system’s warning message is displayed or audible warning is generated, Lane Keeping Assist warning message may not be displayed and audible warning may not be generated.
- You may not hear the warning sound of Lane Keeping Assist if the surrounding is noisy.
  - If you attach objects to the steering wheel, steering may not be assisted properly.
  - Lane Keeping Assist may not operate for 15 seconds after the vehicle is started, or the front view camera is initialized.
  - Lane Keeping Assist will not operate when:
    - The turn signal or hazard warning flasher is turned on.
    - The vehicle is not driven in the center of the lane when Lane Keeping Assist is turned on or right after changing a lane.
    - ESC (Electronic Stability Control) or VSM (Vehicle Stability Management) is activated.
    - The vehicle is driven on a sharp curve.
    - Vehicle speed is below 55 km/h (35 mph) or above 210 km/h (130 mph).
    - The vehicle makes sudden lane changes.
    - The vehicle brakes suddenly.

## BLIND-SPOT COLLISION-AVOIDANCE ASSIST (BCA) (IF EQUIPPED)

Blind-Spot Collision-Avoidance Assist is designed to help detect and monitor approaching vehicles in the driver's blind spot area and warn the driver of a possible collision with a warning message and audible warning.

In addition, if there is a risk of collision when changing lanes or driving forward out of a parking space, Blind-Spot Collision-Avoidance Assist can help avoid a collision by applying the brake.

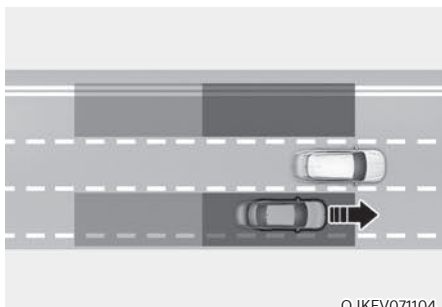

OJKEV071104

Blind-Spot Collision-Avoidance Assist helps detect and informs the driver that a vehicle is in the blind spot.

### CAUTION

The detecting range may vary depending on the speed of your vehicle. Even if there is a vehicle in the blind spot area, Blind-Spot Collision-Avoidance Assist may not warn you when you pass by at high speeds.

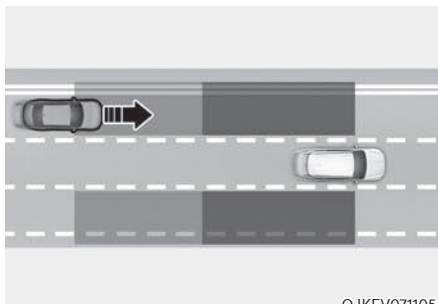

OJKEV071105

Blind-Spot Collision-Avoidance Assist helps detect and informs the driver that a vehicle is approaching at high speed from the blind spot area.

### CAUTION

Warning timing may vary depending on the speed of the vehicle approaching at high speed.

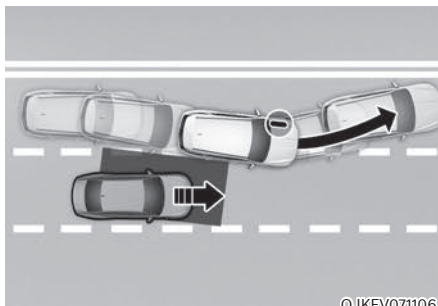

OJKEV071106

When changing lanes by detecting the lane ahead, if Blind-Spot Collision-Avoidance Assist detects that there is a collision risk with an approaching vehicle in the blind spot, it can help avoid collision by applying the brake.

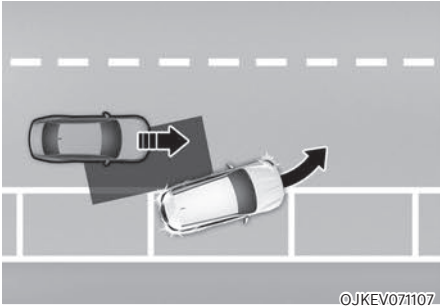

When you are driving forward out of a parking space, if Blind-Spot Collision-Avoidance Assist judges that there is a collision risk with an approaching vehicle in the blind spot, it can help avoid collision by applying the brake.

### Detecting sensor

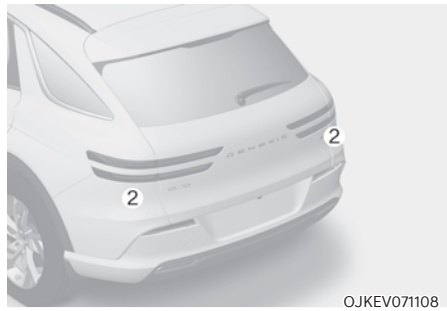

- [1]: Front view camera
- [2]: Rear corner radar

Refer to the picture above for the detailed location of the detecting sensors.



## CAUTION

Take the following precautions to maintain optimal performance of the detecting sensor:

- Never disassemble the detecting sensor assembly, or cause any damage to it.
- If the detecting sensor or the area near the sensor has been damaged or impacted in any way, even though the warning message does not appear on the cluster, Blind-Spot Collision-Avoidance Assist may not operate properly. We recommend that the vehicle be inspected by an authorized retailer of Genesis Branded products.
- If the detecting sensors have been replaced or repaired, we recommend that the vehicle be inspected by an authorized retailer of Genesis Branded products.
- Use only genuine parts to repair the front bumper or rear bumper where the rear corner radar is located.
- Rear bumper genuine parts with rear corner radars have proven their performance. Replacing or painting the rear bumper may result in poor performance of Blind-Spot Collision-Avoidance Assist. When the parts need to be replaced or modified, make sure to use qualified products.
- Do not apply license plate frame or objects, such as a bumper sticker, film or a bumper guard near the rear corner radar.
- Blind-Spot Collision-Avoidance Assist may not work properly if the bumper has been replaced, or the surroundings of the rear corner radar has been damaged or paint has been applied.

- If a trailer, carrier, etc., is installed, it may adversely affect the performance of the rear corner radar or Blind-Spot Collision-Avoidance Assist may not operate.
- For more details on the precautions of the front view camera, refer to “Forward Collision-Avoidance Assist (FCA)” section in this chapter.

## Blind-Spot Collision-Avoidance Assist settings

### *Blind-spot safety*

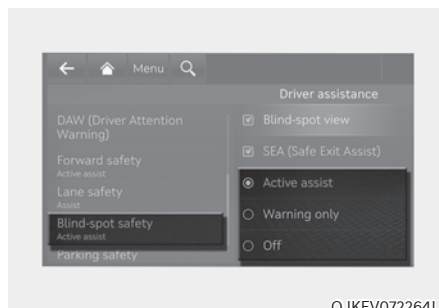

With the vehicle on, select or deselect ‘Driver assistance → Blind-spot safety’ from the Settings menu to set whether to use each function.

- If ‘Active assist’ is selected, Blind-Spot Collision-Avoidance Assist will warn the driver with a warning message, an audible warning and steering wheel vibration depending on the collision risk levels. Braking assist will be applied depending on the collision risk levels.
- If ‘Warning only’ is selected, Blind-Spot Collision-Avoidance Assist will warn the driver with a warning message, an audible warning and steering wheel vibration depending on the collision risk levels. Braking will not be assisted.
- If ‘Off’ is selected, Blind-Spot Collision-Avoidance Assist will turn off.

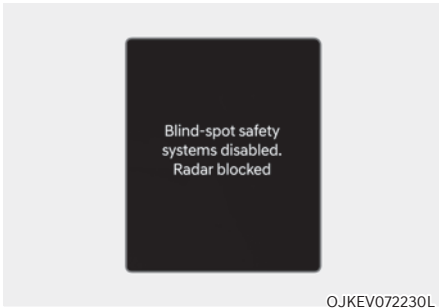

OJKEV072230L

When the vehicle is restarted with Blind-Spot Collision-Avoidance Assist off, the 'Blind-spot safety system is Off' message will appear on the cluster.

If you change the setting from 'Off' to 'Active assist' or 'Warning only', the warning light on the outside rearview mirror will blink for three seconds.

In addition, if the vehicle is turned on, when Blind-Spot Collision-Avoidance Assist is set to 'Active assist' or 'Warning only', the warning light on the outside rearview mirror will blink for three seconds.



### WARNING

- If 'Warning only' is selected, braking is not assisted.
- If 'Off' is selected, the driver should always be aware of the surroundings and drive safely.



### Information

If the vehicle is restarted, Blind-Spot Collision-Avoidance Assist will maintain the last setting.

## Warning timing

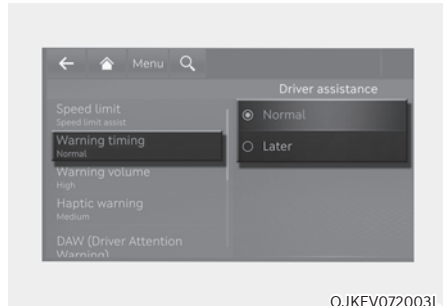

OJKEV072003L

With the vehicle on, select 'Driver assistance → Warning timing' from the Settings menu to change the initial warning activation time for Blind-Spot Collision-Avoidance Assist. The warning time can be set to either 'Normal (Standard)' or 'Later'.

- Use 'Normal (Standard)' in normal driving conditions. If the Warning timing seems sensitive, change it to 'Later'.
- If 'Later' is selected, Blind-Spot Collision-Avoidance Assist, warns the driver more slowly.



### Information

If you change the Warning timing, the Warning timing of other Driver Assistance systems may change.

## Warning volume

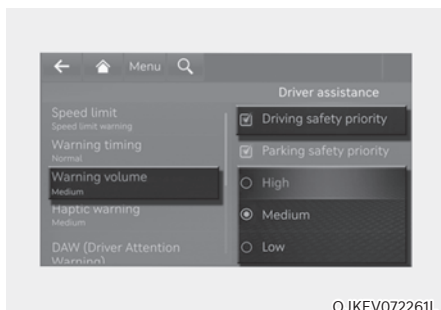

With the vehicle on, select 'Driver assistance → Warning volume' or 'Sound → Driver assistance → Warning volume' from the Settings menu to change the Warning volume to 'High', 'Medium', 'Low' or 'Off' for Blind-Spot Collision-Avoidance Assist.

If 'Driving safety priority' is selected, the vehicle lowers all other audio volumes when the warning sounds for safe driving.

## **i** Information

- If you change the Warning volume, the Warning volume of other Driver Assistance systems may change.
- If 'Off' is selected, steering wheel vibration will not turn off.

## **⚠** CAUTION

- The setting of the Warning timing and Warning volume applies to all functions of Blind-Spot Collision-Avoidance Assist.
- Even though 'Normal (Standard)' is selected for Warning timing, if a vehicle approaches at high speed, the warning may seem late.
- Select 'Later' for Warning timing when traffic is light and when driving speed is slow.

## Blind-Spot Collision-Avoidance Assist operation

### Vehicle detection



- To warn the driver a vehicle is detected, the warning light on the outside rearview mirror and head-up display (if equipped) will illuminate.
- Blind-Spot Collision-Avoidance Assist will operate when your vehicle speed is above 20 km/h (12 mph) and the speed of the vehicle in the blind spot area is above 10 km/h (7 mph).

### Collision warning

- Collision warning will operate when the turn signal is turned on in the direction of the detected vehicle.
- To warn the driver of a collision, the warning light on the outside rearview mirror and head-up display (if equipped) will blink. At the same time, an audible warning will sound and the steering wheel will vibrate.
- When the turn signal is turned off or you move away from the lane, the collision warning will be cancelled and Blind-Spot Collision-Avoidance Assist will return to vehicle detection state.

### Information

If 'Warning only' is selected from the Settings menu, the collision warning will operate when your vehicle approaches the lane the blind spot vehicle is detected.

### WARNING

- The detecting range of the front corner radar or rear corner radar is determined by a standard road width, therefore, on a narrow road, Blind-Spot Collision-Avoidance Assist may detect other vehicles in the next next lane and warn you. In contrast, on a wide road, Blind-Spot Collision-Avoidance Assist may not be able to detect a vehicle driving in the next lane and may not warn you.
- When the hazard warning flasher is on, the collision warning by the turn signal will not operate.

### Collision-Avoidance Assist (while driving)



- To warn the driver of a collision, the warning light on the outside rearview mirror will blink and a warning message will appear on the cluster. At the same time, an audible warning will sound, warning light on the head-up display (if equipped) will blink and the steering wheel will vibrate.
- Emergency braking will be assisted to help prevent collision with the vehicle in the blind spot area.
- Blind-Spot Collision-Avoidance Assist will operate when your vehicle speed is between 60-200 km/h (37-124 mph) and both lane markings of the driving lane are detected.





## CAUTION

- **Collision-avoidance assist will be cancelled under the following circumstances:**
  - your vehicle enters the next lane by a certain distance
  - your vehicle is away from the collision risk
  - the steering wheel is sharply steered
  - the brake pedal is depressed
  - Forward Collision-avoidance assist is operating
- **After Blind-spot Collision-avoidance assist operation or lane change, you must drive to the center of the lane. Blind-spot Collision-avoidance assist will not operate if the vehicle is not driven in the center of the lane.**

### *Collision-avoidance assist (while departing)*



OJKEV072110L

- To warn the driver of a collision, the warning light on the outside rearview mirror will blink and a warning message will appear on the cluster. At the same time, an audible warning will sound, warning light on the head-up display will blink and the steering wheel will vibrate.

- Emergency braking will be assisted to help prevent collision with the vehicle in the blind spot area.
- Blind-Spot Collision-Avoidance Assist will operate when your vehicle speed is below 3 km/h (2 mph) and the speed of the vehicle in the blind spot area is above 5 km/h (3 mph).

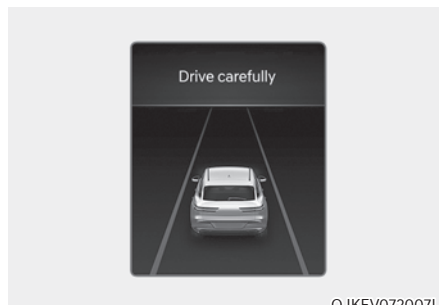

OJKEV072007L

- When the vehicle is stopped due to emergency braking, the 'Drive carefully' warning message will appear on the cluster. For your safety, the driver should depress the brake pedal immediately and check the surroundings.
- Brake control will end after the vehicle is stopped by emergency braking for approximately 2 seconds.



## **WARNING**

Take the following precautions when using Blind-Spot Collision-Avoidance Assist:

- For your safety, only change the Settings after parking the vehicle at a safe location.
- If any other system's warning message is displayed or audible warning is generated, Blind-Spot Collision-Avoidance Assist's warning message may not be displayed and audible warning may not be generated.
- You may not hear the warning sound of Blind-Spot Collision-Avoidance Assist if the surrounding is noisy.
- Blind-Spot Collision-Avoidance Assist may not operate if the driver applies the brake pedal to avoid a collision.
- When Blind-Spot Collision-Avoidance Assist is operating, braking control by the function will automatically cancel when the driver excessively depresses the accelerator pedal or sharply steers the vehicle.
- During Blind-Spot Collision-Avoidance Assist operation, the vehicle may stop suddenly injuring passengers and shifting loose objects. Always have the seat belt on and keep loose objects secured.
- Even if there is a problem with Blind-Spot Collision-Avoidance Assist, the vehicle's basic braking performance will operate properly.

- Blind-Spot Collision-Avoidance Assist does not operate in all situations and cannot avoid all collisions.
- Blind-Spot Collision-Avoidance Assist may warn the driver late or may not warn the driver depending on the road and driving conditions.
- Driver should maintain control of the vehicle at all times. Do not depend on Blind-Spot Collision-Avoidance Assist. Maintain a safe braking distance, and if necessary, depress the brake pedal to reduce driving speed or to stop the vehicle.
- Never operate Blind-Spot Collision-Avoidance Assist on people, animal, objects, etc. It may cause serious injury or death.



## **WARNING**

The brake control may not operate properly depending on the status of ESC (Electronic Stability Control).

There will only be a warning when:

- The ESC (Electronic Stability Control) warning light is on
- ESC (Electronic Stability Control) is engaged in a different function

## Blind-Spot Collision-Avoidance Assist malfunction and limitations

### *Blind-Spot Collision-Avoidance Assist malfunction*

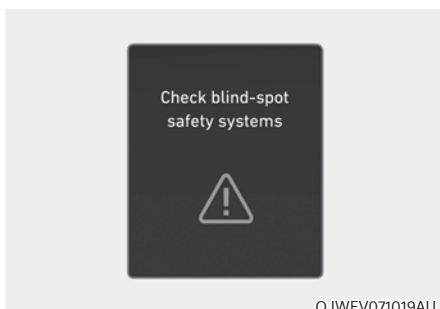

OJWEV071019AU

When Blind-Spot Collision-Avoidance Assist is not working properly, the 'Check blind-spot Safety system(s)' warning message will appear on the cluster for several seconds, and the master (⚠) warning light will illuminate on the cluster. If this occurs, we recommend that the vehicle be inspected by an authorized retailer of Genesis Branded products.

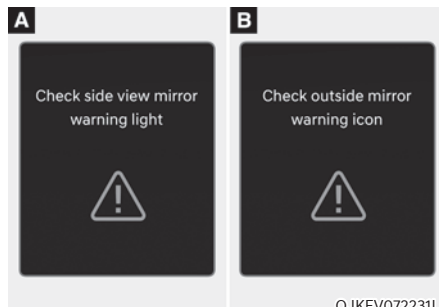

OJKEV072231L

When the outside rearview mirror warning light is not working properly, the 'Check outside mirror warning icon' (or 'Check side view mirror warning light') warning message will appear on the cluster for several seconds, and the master (⚠) warning light will illuminate on the cluster. If this occurs, we recommend that the vehicle be inspected by an authorized retailer of Genesis Branded products.

### **Blind-Spot Collision-Avoidance Assist disabled**

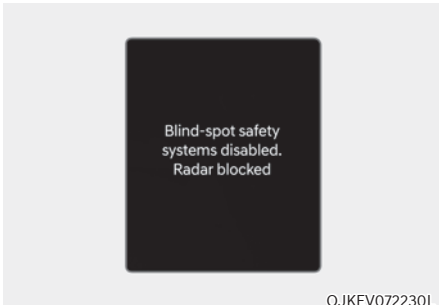

When the rear bumper around the rear corner radar or sensor is covered with foreign material, such as snow or rain, or installing a trailer or carrier, it can reduce the detecting performance and temporarily limit or disable Blind-Spot Collision-Avoidance Assist.

If this occurs, the 'Blind-spot safety system(s) disabled. Radar blocked' warning message will appear on the cluster.

Blind-Spot Collision-Avoidance Assist will operate properly when such foreign material or trailer, etc., is removed, and then the vehicle is restarted.

If Blind-Spot Collision-Avoidance Assist does not operate properly after it is removed, we recommend that the vehicle be inspected by an authorized retailer of Genesis Branded products.

### **WARNING**

- Even though the warning message does not appear on the cluster, Blind-Spot Collision-Avoidance Assist may not properly operate.
- Blind-Spot Collision-Avoidance Assist may not properly operate in an area (for example, open terrain) where any objects are not detected right after the vehicle is turned on, or when the detecting sensor is blocked with foreign material right after the vehicle is turned on.

### **CAUTION**

**Turn off Blind-Spot Collision-Avoidance Assist to install or remove a trailer, carrier, or another attachment. Turn on Blind-Spot Collision-Avoidance Assist when finished.**

### **Limitations of Blind-Spot Collision-Avoidance Assist**

Blind-Spot Collision-Avoidance Assist may not operate properly, or it may operate unexpectedly under the following circumstances:

- There is inclement weather, such as heavy snow, heavy rain, etc.
- The detecting sensor is covered with snow, rain, dirt, etc.
- The temperature around the detecting sensor is high or low due to surrounding environment.
- The detecting sensor is blocked while driving near a vehicle, pillar, or wall.
- Driving on a highway (or motorway) ramp or driving through a tollgate.

- The road pavement (or the peripheral ground) abnormally contains metallic components (for example, possibly due to subway construction).
- There is a fixed object near the vehicle, such as sound barriers, guardrails, central dividers, entry barriers, street lamps, signs, tunnels, walls, etc. (including double structures)
- Driving through a narrow road where trees or grass are overgrown
- Driving in vast areas where there are few vehicles or structures (for example, desert, meadow, suburb, etc.)
- The lane is difficult to see due to foreign material, such as rain, snow, dust, sand, oil and water puddles
- The color of the lane marking is not distinguishable from the road
- There are markings on the road near the lane or the markings on the road look similar to the lane markings
- The shadow is on the lane marking by a median strip, trees, guardrail, noise barriers, etc.
- The lane number increases or decreases, or the lane markings are crossing
- There are more than two lane markings on the road
- The lane markings are complicated or a structure substitutes for the lines, such as a construction area
- There are road markings, such as zigzag lanes, crosswalk markings and road signs
- The lane suddenly disappears, such as at the intersection
- The lane is very wide or narrow
- There is a curb or road edges without a lane
- The vehicle in front is driving with one side on the lane marking
- The distance to the front vehicle is extremely
- The other vehicle drives very close behind your vehicle, or the other vehicle passes by your vehicle in close proximity
- The speed of the other vehicle is very fast that it passes by your vehicle in a short time
- Your vehicle passes by the other vehicle
- Your vehicle changes lane
- Your vehicle has started at the same time as the vehicle next to you and has accelerated
- The vehicle in the next lane moves two lanes away from you, or when the vehicle two lanes away moves to the next lane from you
- A trailer, carrier or other attachment is installed around the rear corner radar
- The bumper around the rear corner radar is covered with objects, such as a bumper sticker, bumper guard, bike rack, etc.
- The bumper around the rear corner radar is impacted, damaged or the radar is out of position
- Your vehicle height is low or high due to heavy loads, abnormal tire pressure, etc.

Blind-Spot Collision-Avoidance Assist may not operate properly, or it may operate unexpectedly when the following objects are detected:

- A motorcycle or bicycle is detected
- A vehicle such as a flat trailer is detected
- A big vehicle such as a bus or truck is detected
- A moving obstacle such as a pedestrian, animal, shopping cart or a baby stroller is detected
- A vehicle with low height such as a sports car is detected

Braking control may not work, driver's attention is required in the following circumstances:

- The vehicle severely vibrates while driving over a bumpy road, uneven road or concrete patch
- Driving on a slippery surface due to snow, water puddle, ice, etc.
- The tire pressure is low or a tire is damaged
- The braking system has been modified
- The vehicle makes abrupt lane changes

**i Information**

For more details on the limitations of the front view camera, refer to “Forward Collision-Avoidance Assist (FCA)” and “Lane Keeping Assist (LKA)” section in this chapter.

• **Driving on a curved road**

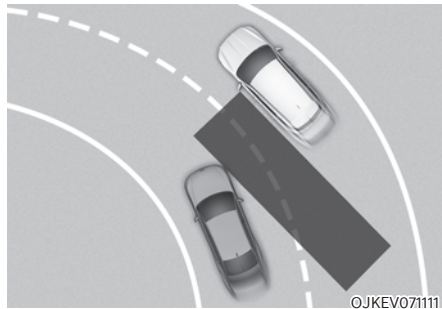

**Blind-Spot Collision-Avoidance Assist may not operate properly when driving on a curved road. The function may not detect the vehicle in the next lane.**

**Always pay attention to road and driving conditions while driving.**

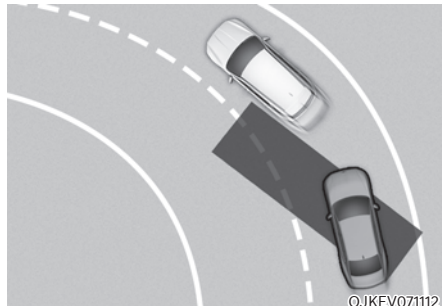

**Blind-Spot Collision-Avoidance Assist may not operate properly when driving on a curved road. The function may recognize a vehicle in the same lane.**

**Always pay attention to road and driving conditions while driving.**

- Driving on an inclined road

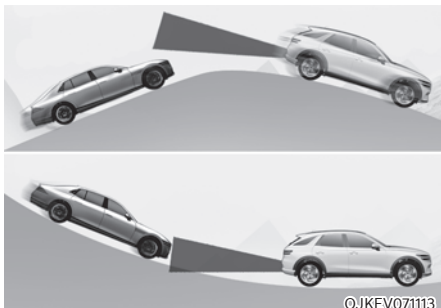

©JKEV071113

**Blind-Spot Collision-Avoidance Assist** may not operate properly when driving on a slope. The function may not detect the vehicle in the next lane or may incorrectly detect the ground or structure. Always pay attention to road and driving conditions while driving.

- Driving where the road is merging/ dividing

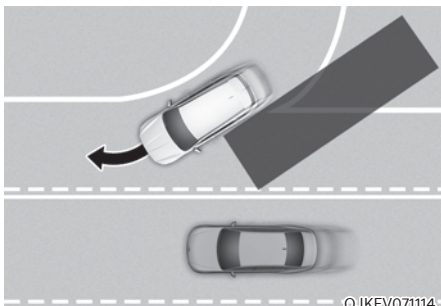

©JKEV071114

**Blind-Spot Collision-Avoidance Assist** may not operate properly when driving where the road merges or divides. The function may not detect the vehicle in the next lane. Always pay attention to road and driving conditions while driving.

- Driving where the heights of the lanes are different

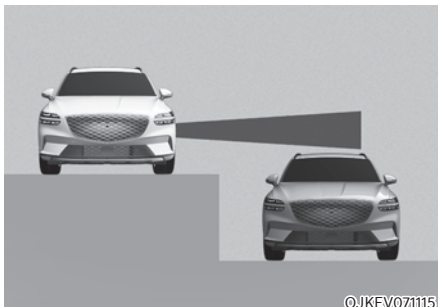

©JKEV071115

**Blind-Spot Collision-Avoidance Assist** may not operate properly when driving where the heights of the lanes are different. The function may not detect the vehicle on a road with different lane heights (underpass joining section, grade separated intersections, etc.).

Always pay attention to road and driving conditions while driving.



## WARNING

- When you are towing a trailer or another vehicle, make sure that you turn off **Blind-Spot Collision-Avoidance Assist**.
- **Blind-Spot Collision-Avoidance Assist** may not operate properly if interfered by strong electromagnetic waves.
- **Blind-Spot Collision-Avoidance Assist** may not operate for 15 seconds after the vehicle is started, or the front view camera or rear corner radars are initialized.

## SAFE EXIT WARNING (SEW) (IF EQUIPPED)

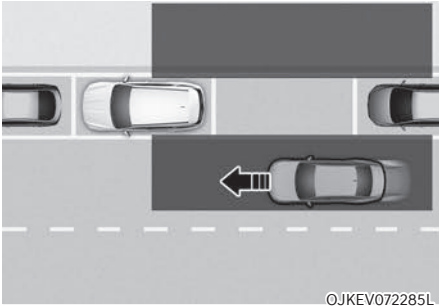

After the vehicle stops, when an approaching vehicle from the rear area is detected after a passenger opens the door, Safe Exit Warning will warn the driver with a warning message and an audible warning to help prevent a collision.

### CAUTION

Warning timing may vary depending on the speed of the approaching vehicle.

### Detecting sensor

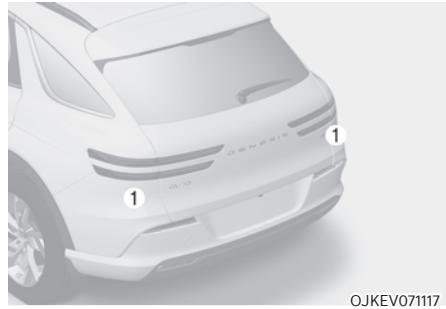

[1] : Rear corner radar

Refer to the picture above for the detailed location of the detecting sensors.

### CAUTION

For more details on the precautions of the rear corner radars, refer to “Blind-Spot Collision-Avoidance Assist (BCA)” section in this chapter.



## Safe Exit Warning settings

### Setting features

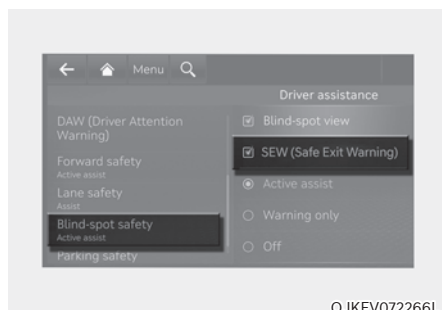

### Safe Exit Warning

With the vehicle on, select 'Driver assistance → Blind-spot safety → SEW (Safe Exit Warning)' from the Settings menu to turn on Safe Exit Warning and deselect to turn off the function.



### WARNING

The driver should always be aware of the surroundings. If 'Safe Exit Warning' is deselected, Safe Exit Warning cannot assist you.



### Information

If the vehicle is restarted, Safe Exit Warning will maintain the last setting.

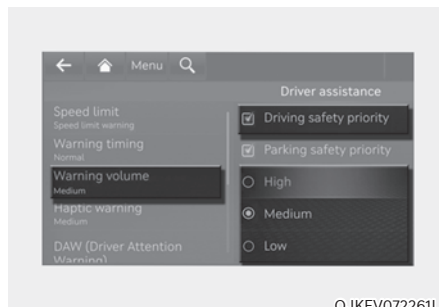

### Warning volume

With the vehicle on, select 'Driver assistance → Warning volume' or 'Sound → Driver assistance → Warning volume' from the Settings menu to change the Warning volume to 'High', 'Medium', 'Low' or 'Off' for Safe Exit Warning.

If 'Driving safety priority' is selected, the vehicle lowers all other audio volumes when the warning sounds for safe driving.



### Information

- If you change the Warning volume, the Warning volume of other Driver Assistance systems may change.
- If 'Off' is selected, the Warning volume of Safe Exit Assist will not turn off, but the volume will sound as 'Low'.



### CAUTION

- The setting of the Warning timing and Warning volume applies to all functions of Safe Exit Warning.

## Safe Exit Warning operation

### Safe Exit Warning

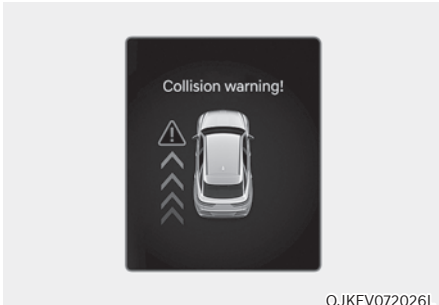

OJKEV072026L

#### Collision warning when exiting vehicle

- When an approaching vehicle from the rear is detected at the moment a door is opened, the 'Collision warning!' warning message will appear on the cluster, and an audible warning will sound.
  - Safe Exit Warning will warn the driver when your vehicle speed is below 3 km/h (2 mph), and the speed of the approaching vehicle from the rear is above 6 km/h (4 mph).
- Safe Exit Warning does not operate in all situations and cannot prevent all collisions.
  - Safe Exit Warning may warn the driver late or may not warn the driver depending on the road and driving conditions. Always check vehicle surroundings.
  - The driver and passengers are responsible for accidents that occur while exiting the vehicle. Always check the surroundings before you exit the vehicle.
  - Never deliberately operate Safe Exit Warning. Doing so may lead to serious injury or death.
  - Safe Exit Warning does not operate if there is a problem with Blind-Spot Collision-Avoidance Assist. The warning message of Blind-Spot Collision-Avoidance Assist will appear when:
    - Blind-Spot Collision-Avoidance Assist sensor or the sensor surrounding is polluted or covered
    - Blind-Spot Collision-Avoidance Assist fails to warn passengers or falsely warn passengers



### WARNING

Take the following precautions when using Safe Exit Warning:

- For your safety, only change the Settings after parking the vehicle at a safe location.
- If any other system's warning message is displayed or audible warning is generated, Safe Exit Warning's warning message may not be displayed and audible warning may not be generated.
- You may not hear the warning sound of Safe Exit Warning if the surroundings are noisy.



### Information

After the vehicle is turned off, Safe Exit Warning operates approximately for 3 minutes, but turns off immediately if the doors are locked.

## Safe Exit Warning malfunction and limitations

### Safe Exit Warning malfunction

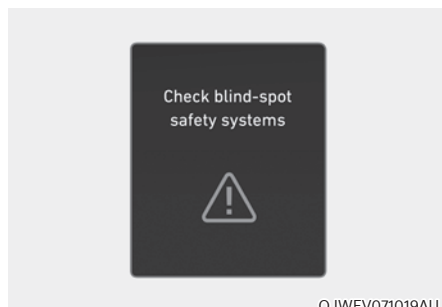

When Safe Exit Warning is not working properly, the 'Check blind-spot safety system(s)' warning message will appear on the cluster for several seconds, and the master (⚠) warning light will illuminate on the cluster. If this occurs, we recommend that the vehicle be inspected by an authorized retailer of Genesis Branded products.

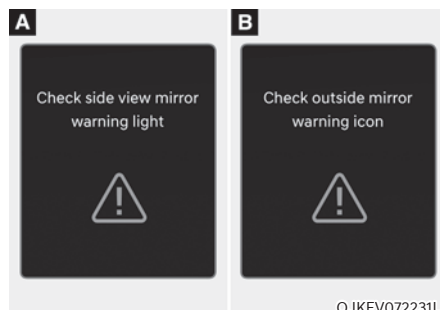

When the outside rearview mirror warning light is not working properly, the 'Check side view mirror warning light' (or 'Check outside mirror warning icon') warning message will appear on the cluster for several seconds, and the master (⚠) warning light will illuminate on the cluster. If this occurs, we recommend that the vehicle be inspected by an authorized retailer of Genesis Branded products.

### Safe Exit Warning disabled

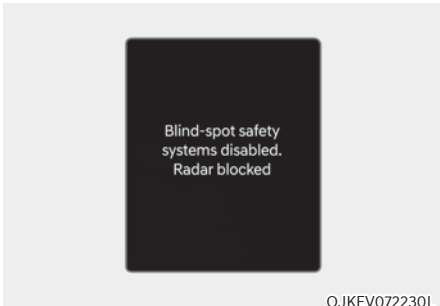

When the rear bumper around the rear corner radar or sensor is covered with foreign material, such as snow or rain, or installing a trailer or carrier, it can reduce the detecting performance and temporarily limit or disable Safe Exit Warning.

If this occurs, the 'Blind-spot safety system(s) disabled. Radar blocked' warning message will appear on the cluster.

Safe Exit Warning will operate properly when such foreign material or trailer, etc., is removed, and then the vehicle is restarted.

If Safe Exit Warning does not operate properly after it is removed, we recommend that the vehicle be inspected by an authorized retailer of Genesis Branded products.

### WARNING

- Even though the warning message does not appear on the cluster, Safe Exit Warning may not properly operate.
- Safe Exit Warning may not properly operate in an area (for example, open terrain) where any objects are not detected right after the vehicle is turned on, or when the detecting sensor is blocked with foreign material right after the vehicle is turned on.

### CAUTION

Turn off Safe Exit Warning to install or remove a trailer, carrier, or another attachment. Turn on Safe Exit Warning when finished.

### Limitations of Safe Exit Warning

Safe Exit Warning may not operate properly, or it may operate unexpectedly under the following circumstances:

- Getting out of the vehicle where trees or grass are overgrown
- Getting out of the vehicle where the road is wet
- The approaching vehicle is very fast or very slow

### Information

For more details on the limitations of the rear corner radar, refer to "Blind-Spot Collision-Avoidance Assist (BCA)" section in this chapter.

### WARNING

- Safe Exit Warning may not operate properly if interfered by strong electromagnetic waves.
- Safe Exit Warning may not operate for 3 seconds after the vehicle is started, or the rear corner radars are initialized.

## SAFE EXIT ASSIST (SEA) (IF EQUIPPED)

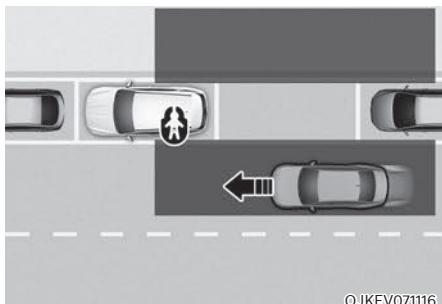

OJKEV071116

After the vehicle stops, when an approaching vehicle from the rear area is detected after a passenger opens the door, Safe Exit Assist will warn the driver with a warning message and an audible warning to help prevent a collision.



OJKEV051019

In addition, when the electronic child safety lock button is in the LOCK position and an approaching vehicle from the rear area is detected, the electronic child safety lock button will not unlock even if the driver presses the button to prevent the rear doors from opening.

### CAUTION

- Warning timing may vary depending on the speed of the approaching vehicle.
- Do not use Safe Exit Assist instead of the electronic child safety lock button. To protect rear seat passengers, use the electronic child safety lock button.

For more details on, refer to "Electronic Child Safety Lock" section in chapter 5.

### *Detecting sensor*

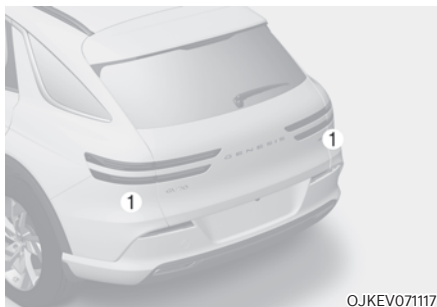

OJKEV071117

[1]: Rear corner radar

Refer to the picture above for the detailed location of the detecting sensors.

### CAUTION

For more details on the precautions of the rear corner radars, refer to "Blind-Spot Collision-Avoidance Assist (BCA)" section in this chapter.

## Safe Exit Assist settings

### Safe Exit Assist

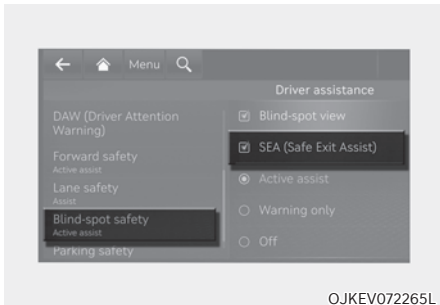

With the vehicle on, select 'Driver assistance → Blind-spot safety → SEA (Safe Exit Assist)' from the Settings menu to turn on Safe Exit Assist and deselect to turn off the function.

### WARNING

The driver should always be aware of his or her surroundings. If 'SEA (Safe Exit Assist)' is deselected, Safe Exit Assist cannot assist you.

### Information

If the vehicle is restarted, Safe Exit Assist will maintain the last setting.

## Warning volume

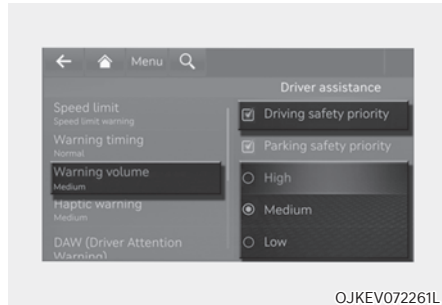

With the vehicle on, select 'Driver assistance → Warning volume' or 'Sound → Driver assistance → Warning volume' from the Settings menu to change the Warning volume 'High', 'Medium', 'Low' or 'Off' for Safe Exit Assist.

If 'Driving safety priority' is selected, the vehicle lowers all other audio volumes when the warning sounds for safe driving.

### Information

- If you change the Warning volume, the Warning volume of other Driver Assistance systems may change.
- If 'Off' is selected, the Warning volume of Safe Exit Assist will not turn off, but the volume will sound as 'Low'.

### CAUTION

The setting of the Warning timing and Warning volume applies to all functions of Safe Exit Assist.

## Safe Exit Assist operation

### Collision warning when exiting vehicle

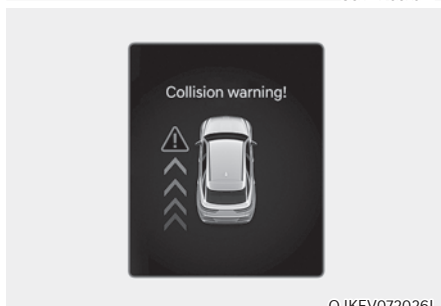

- When an approaching vehicle from the rear is detected at the moment a door is opened, the 'Collision warning!' warning message will appear on the cluster, and an audible warning will sound.
- Safe Exit Assist will warn the driver when your vehicle speed is below 3 km/h (2 mph), and the speed of the approaching vehicle from the rear is above 6 km/h (4 mph).

## Safe Exit Assist linked with Electronic child safety lock

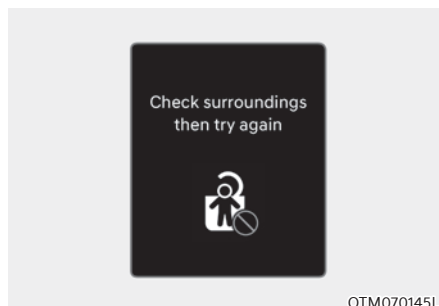

- When Electric child safety lock is operating and an approaching vehicle from the rear area is detected, the rear doors cannot be unlocked even if the driver tries to unlock the rear doors using the electronic child safety lock button. The warning light on the outside rearview mirror will blink and 'Check surroundings then try again' warning message will appear on the cluster.
- Safe Exit Assist will warn the driver when vehicle speed is below 3 km/h (2 mph) and the speed of the approaching vehicle from the rear is above 6 km/h (4 mph).

### **i** Information

**For more details on electric child safety lock button, refer to "Electronic Child Safety Lock" section in chapter 5.**



### CAUTION

If the driver presses the electronic child safety lock button again within 10 seconds after the warning message appears, Safe Exit Assist judges that the driver has unlocked the doors acknowledging the rear status. The electronic child safety lock will turn off (button indicator OFF) and the rear doors will unlock. Always check the surroundings before turning off the electronic child safety lock button.



### Information

If a rear door is opened from the outside, it will open regardless of Safe Exit Assist operation.



### WARNING

Take the following precautions when using Safe Exit Assist:

- For your safety, change the Settings after parking the vehicle at a safe location.
- If any other system's warning message is displayed or audible warning is generated, Safe Exit Assist warning message may not be displayed and audible warning may not be generated.
- You may not hear the warning sound of Safe Exit Assist if the surrounding is noisy.
- Safe Exit Assist does not operate in all situations or cannot prevent all collisions.
- Safe Exit Assist may warn the driver late or may not warn the driver depending on the road and driving conditions. Always check vehicle surroundings.
- The driver and passengers are responsible for accidents that occurs while exiting the vehicle. Always check the surroundings before you exit the vehicle.
- Never deliberately operate Safe Exit Assist. Doing so may lead to serious injury or death.



### Information

- After the vehicle is turned off, Safe Exit Assist operates approximately for 3 minutes, but turns off immediately if the doors are locked.
- The images and colors in the instrument cluster may differ depending on the cluster type or theme selected from the settings menu.



## Safe Exit Assist malfunction and limitations

### Safe Exit Assist malfunction

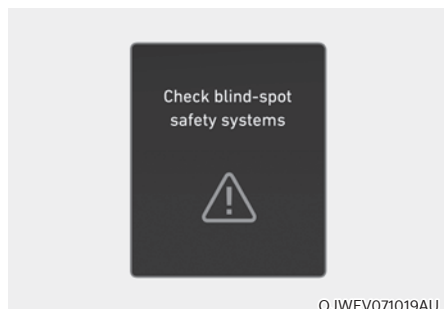

When Safe Exit Assist is not working properly, the 'Check Blind-spot safety system(s)' warning message will appear on the cluster for several seconds, and the master (⚠) warning light will illuminate on the cluster. If this occurs, we recommend that the vehicle be inspected by an authorized retailer of Genesis Branded products.

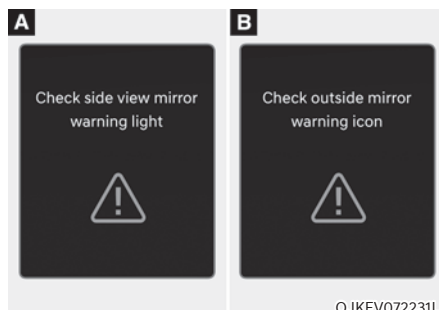

When the outside rearview mirror warning light is not working properly, the 'Check outside mirror warning icon' (or 'Check side view mirror warning light') warning message will appear on the cluster for several seconds, and the master (⚠) warning light will illuminate on the cluster. If this occurs, we recommend that the vehicle be inspected by an authorized retailer of Genesis Branded products.

### Safe Exit Assist disabled

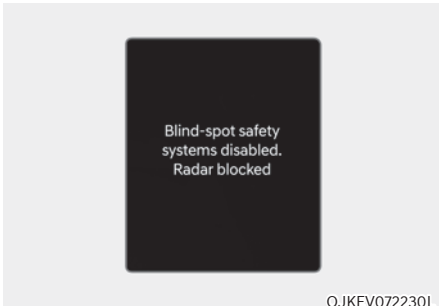

When the rear bumper around the rear corner radar or sensor is covered with foreign material, such as snow or rain, or installing a trailer or carrier, it can reduce the detecting performance and temporarily limit or disable Safe Exit Assist.

If this occurs, the 'Blind-spot safety system(s) disabled. Radar blocked' warning message will appear on the cluster.

Safe Exit Assist will operate properly when such foreign material or trailer, etc., is removed, and then the vehicle is restarted.

If Safe Exit Assist does not operate properly after it is removed, we recommend that the vehicle be inspected by an authorized retailer of Genesis Branded products.

### WARNING

- Even though the warning message does not appear on the cluster, Safe Exit Assist may not properly operate.
- Safe Exit Assist may not properly operate in an area (for example, open terrain) where any objects are not detected right after the vehicle is turned on, or when the detecting sensor is blocked with foreign material right after the vehicle is turned on.

### CAUTION

Turn off Safe Exit Assist to install or remove a trailer, carrier, or another attachment. Turn on Safe Exit Assist when finished.

### Limitations of Safe Exit Assist

Safe Exit Assist may not operate properly, or it may operate unexpectedly under the following circumstances:

- Getting out of the vehicle where trees or grass are overgrown
- Getting out of the vehicle where the road is wet
- The approaching vehicle is very fast or very slow

### Information

For more details on the limitations of the rear corner radar, refer to “Blind-Spot Collision-Avoidance Assist (BCA)” section in this chapter.

### WARNING

- Safe Exit Assist may not operate properly if interfered by strong electromagnetic waves.
- Safe Exit Assist may not operate for 3 seconds after the vehicle is started, or the rear corner radars are initialized.

## MANUAL SPEED LIMIT ASSIST (MSLA)



- (1) Speed Limit indicator
- (2) Set speed

You can set the speed limit when you do not want to drive over a specific speed.

If you drive over the preset speed limit, Manual Speed Limit Assist operates (set speed limit will blink and chime will sound) until the vehicle speed returns within the speed limit.

### Manual Speed Limit Assist operation

#### Setting speed limit



1. Press and hold Driving Assist ( (1)) button at the desired speed. The Speed Limit ( LIMIT) indicator will illuminate on the cluster.

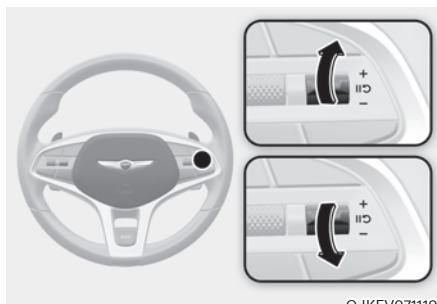

2. Push the + switch up or - switch down, and release it at the desired speed.

Push the + switch up or - switch down and hold it. The speed will increase or decrease to the nearest multiple of ten (multiple of five in mph) at first, and then increase or decrease by 10 km/h (5 mph).





3. The set speed limit will be displayed on the cluster.  
If you would like to drive over the preset speed limit, depress the accelerator pedal beyond the pressure point to activate the kickdown function.  
The set speed limit will blink and chime will sound until you return the vehicle speed within the speed limit.

**i** Information

**When the accelerator pedal is not depressed beyond the pressure point, vehicle speed will maintain within the speed limit.**

**Temporarily pausing Manual Speed Limit Assist**



Press the  switch to temporarily pause the set speed limit. The set speed limit will turn off but the Speed Limit () indicator will stay on.

### Resuming Manual Speed Limit Assist





To resume Manual Speed Limit Assist after the function was paused, operate the +, -,  switch.

If you push the + switch up or - switch down, vehicle speed will be set to the current speed on the cluster.

If you press the  switch, vehicle speed will resume to the preset speed.

### Turning off Manual Speed Limit Assist



Press the Driving Assist () button to turn Manual Speed Limit Assist off. The Speed Limit () indicator will go off.

### WARNING

Take the following precautions when using Manual Speed Limit Assist:

- Always set the vehicle speed under the speed limit in your area.
- Keep Manual Speed Limit Assist off when the function is not in use, to avoid inadvertently setting a speed. Check that the Speed Limit () indicator is off.
- Manual Speed Limit Assist does not substitute for proper and safe driving. It is the responsibility of the driver to always drive safely and be aware of unexpected and sudden situations. Pay attention to the road conditions at all times.

## INTELLIGENT SPEED LIMIT ASSIST (ISLA) (IF EQUIPPED)

Intelligent Speed Limit Assist uses information from the detected road sign and navigation system to inform the driver of the speed limit and additional information of the current road. Also, Intelligent Speed Limit Assist helps the driver to maintain within the speed limit of the road.

### CAUTION

- **Intelligent Speed Limit Assist may not operate properly if the function is used in other countries.**
- **If a navigation is applied to your vehicle, the navigation needs to be regularly updated for Intelligent Speed Limit Assist to operate properly.**

### Detecting sensor



OJKEV051076

[1]: Front view camera

Refer to the picture above for the detailed location of the detecting sensor.

### CAUTION

For more details on the precautions of the front view camera, refer to “Forward Collision-Avoidance Assist (FCA)” section in this chapter.

## Intelligent Speed Limit Assist settings

### Speed Limit

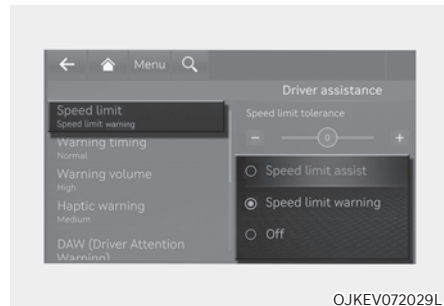

OJKEV072029L

With the vehicle on, select or deselect ‘Driver assistance → Speed limit’ from the Settings menu to set whether to use each function.

- If ‘Speed limit assist’ is selected, Intelligent Speed Limit Assist will inform the driver of speed limit and additional road signs. In addition, Intelligent Speed Limit Assist will inform the driver to change set speed of Manual Speed Limit Assist and/or Smart Cruise Control to help the driver stay within the speed limit.
- If ‘Speed limit warning’ is selected, Intelligent Speed Limit Assist will inform the driver of speed limit and additional road signs. In addition, Intelligent Speed Limit Assist will warn the driver when the vehicle is driven faster than the speed limit.
- If ‘Off’ is selected, Intelligent Speed Limit Assist will turn off.

## Speed Limit Offset

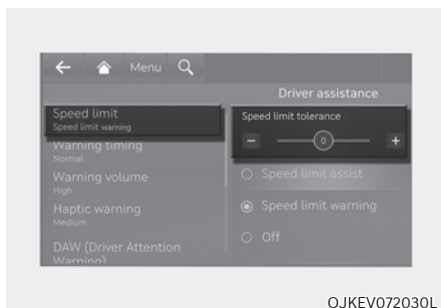

With the vehicle on, when 'Driver assistance → Speed limit → Speed limit tolerance (Speed Limit Offset)' is selected, the Speed Limit Offset can be changed. Speed Limit Warning and Speed Limit Assist will operate by applying the Speed Limit Offset setting to the detected speed limit.



### WARNING

For your safety, only change the Settings after parking the vehicle at a safe location.



### Information

- The setting of 'Speed Offset' is not reflected in Navigation-based Smart Cruise Control (NSCC).
- Speed Limit Assist function operates based on the Offset setting added to the speed limit. If you want to change the set speed according to the speed limit, adjust the offset to '0'.
- Speed Limit Warning function warns the driver when driving speed exceeds the speed at which the set Offset is added to speed limit. If you want Speed Limit Warning to warn you immediately when the driving speed exceeds the speed limit, adjust the offset to '0'.

## Intelligent Speed Limit Assist operation

Intelligent Speed Limit Assist will warn and control the vehicle by 'Displaying speed limit', 'Warning overspeed' and 'Changing set speed'.



### Information

Intelligent Speed Limit Assist warning and control are described based on the Offset adjust to '0'. For details on Offset setting, refer to the "Intelligent Speed Limit Assist Settings".

### Displaying speed limit



OJKEV072031L

Speed limit information is displayed on the instrument cluster.

### **i** Information

- If speed limit information of the road cannot be recognized, '---' sign will be displayed. Refer to "Limitations of Intelligent Speed Limit Assist" if the road signs are difficult to recognize.
- Intelligent Speed Limit Assist provides additional road sign information in addition to speed limit. The additional road sign information provided may vary according to your country.
- Supplementary sign displayed under the speed limit or overtaking restriction sign means the conditions under which the signs must be followed. If the supplementary sign is not recognized, it is displayed as blank.
- The images and colors in the instrument cluster may differ depending on the cluster type or theme selected from the settings menu.

### Warning overspeed

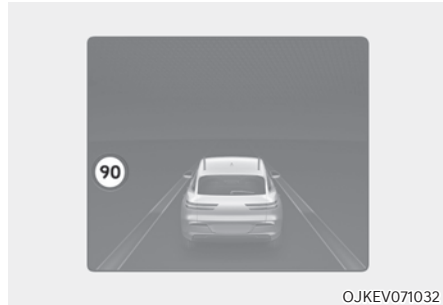

OJKEV071032

When driving at a speed higher than the displayed speed limit, the speed limit is displayed in red.

### Changing set speed



OJKEV072033L

OJKEV072034L

If the speed limit of the road changes during the operation of Manual Speed Limit Assist or Smart Cruise Control, an arrow in the direction of up or down is displayed to inform the driver that the set speed needs to be changed. At this time, the driver can change the set speed according to the speed limit by using the + or - switch on the steering wheel.



## WARNING

- If the Offset is adjusted over '0', the set speed will change to a higher speed than the speed limit of the road. If you want to drive below the speed limit, adjust the Offset under '0' or use the – switch on the steering wheel to lower the set speed.
- Even after changing the set speed according to the speed limit of the road, the vehicle can still be driven over the speed limit. If necessary, depress the brake pedal to reduce your driving speed.
- If the speed limit of the road is under 30 km/h (20 mph), the set speed change function will not work.
- Intelligent Speed Limit Assist operates using the speed unit in the instrument cluster set by the driver. If the speed unit is set to a unit other than the speed unit used in your area, Intelligent Speed Limit Assist may not operate properly.

## Information

- For more details on Manual Speed Limit Assist operation, refer to “Manual Speed Limit Assist (MSLA)” section in this chapter.
- For more details on Smart Cruise Control operation, refer to “Smart Cruise Control (SCC)” section in this chapter.

## Intelligent Speed Limit Assist malfunction and limitations

### *Intelligent Speed Limit Assist malfunction*

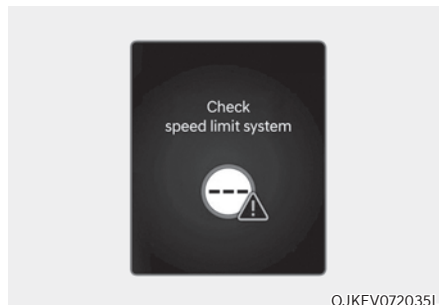

When Intelligent Speed Limit Assist is not working properly, the 'Check speed limit system' warning message will appear on the cluster for several seconds, and the master () warning light will illuminate on the cluster. If this occurs, we recommend that the vehicle be inspected by an authorized retailer of Genesis Branded products.

### Intelligent Speed Limit Assist disabled

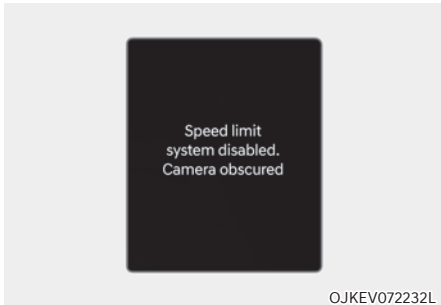

When the front windshield where the front view camera is located is covered with foreign material, such as snow or rain, it can reduce the detecting performance and temporarily limit or disable Intelligent Speed Limit Assist. If this occurs, the 'Speed limit system disabled. Camera obscured' warning message will appear on the cluster.

Intelligent Speed Limit Assist will operate properly when snow, rain or foreign material is removed.

If Intelligent Speed Limit Assist does not operate properly after it is removed, we recommend that the vehicle be inspected by an authorized retailer of Genesis Branded products.



#### **WARNING**

**If the detecting sensor is contaminated immediately after starting the vehicle, Intelligent Speed Limit Assist may not operate properly.**

### Limitations of Intelligent Speed Limit Assist

Intelligent Speed Limit Assist may not operate properly, or it may operate unexpectedly under the following circumstances:

- The road sign is contaminated or indistinguishable
  - The road sign is difficult to see due to bad weather, such as rain, snow, fog, etc.
  - The road sign is not clear or damaged
  - The road sign is partially obscured by surrounding objects or shadow
- The road signs do not conform to the standard
  - The text or picture on the road sign is different from the standard
  - The road sign is installed between the main line and the exit road or between diverging roads
  - There is no conditional road signs on the road sign located on the exit road
  - A sign is attached to another vehicle
- The distance between the vehicle and the road signs is too far
- The vehicle encounters illuminant road signs
- Intelligent Speed Limit Assist incorrectly recognizes numbers or pictures in the street signs or other signs as the speed limit
- A road sign near the road you are driving is detected
- Multiple signs are installed close together
- The minimum speed limit sign is misrecognized

- The minimum speed limit sign is on the road
- The brightness changes suddenly, for example when entering or exiting a tunnel or passing under a bridge
- Headlamps are not used or the brightness of the headlamps are weak at night or in the tunnel
- Road signs are difficult to recognize due to the reflection of sunlight, street lights, or oncoming vehicles
- The navigation information or GPS information contain errors.
- The driver does not follow the guide of the navigation.
- The driver is driving a new road that is not in the navigation system yet.
- The field of view of the front view camera is obstructed by sun glare
- Driving on a road that is sharply curved or continuously curved
- Driving through speed bumps, or driving up and down or left to right on steep inclines
- The vehicle is shaking heavily
- Driving on a newly opened road



## WARNING

- **Intelligent Speed Limit Assist is a supplemental function that helps the driver to comply with the speed limit on the road, and may not display the correct speed limit or control the driving speed properly.**
- **Always set the vehicle speed to the speed limit in your area.**
- **Intelligent Speed Limit Assist may not operate for 15 seconds after the vehicle is started, or the front view camera is initialized.**



## Information

**For more details on the limitations of the front view camera, refer to “Forward Collision-Avoidance Assist (FCA)” section in this chapter.**

## DRIVER ATTENTION WARNING (DAW) (IF EQUIPPED)

### Basic function

Driver Attention Warning can help determine the driver's attention level by analyzing driving pattern and driving time while the vehicle is driven. Driver Attention Warning will recommend a break when the driver's attention level falls below a certain level.

### Leading vehicle departure alert function

Leading Vehicle Departure Alert function will inform the driver when a detected vehicle in front departs.

### Detecting sensor



OJKEV051076

[1]: Front view camera

The front view camera is used as a detecting sensor to help detect driving patterns and front vehicle departure while vehicle is being driven.

Refer to the picture above for the detailed location of the detecting sensor.



### CAUTION

- Always keep the front view camera in good condition to maintain optimal performance of Driver Attention Warning.
- For more details on the precautions of the front view camera, refer to "Forward Collision-Avoidance Assist (FCA)" section in this chapter.

### Driver Attention Warning settings Driver Attention Warning

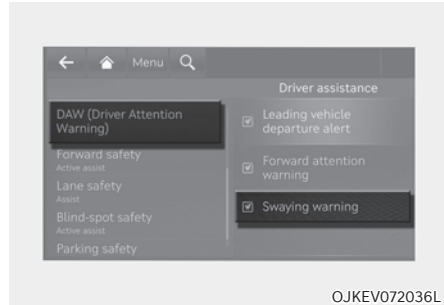

OJKEV072036L

With the vehicle on, select or deselect 'Driver assistance → DAW (Driver Attention Warning)' from the Settings menu to set whether to use each function.

- If 'Swaying warning (Inattentive Driving Warning)' is selected, Driver Attention Warning will recommend taking a break when the level falls below a certain level.

### Information

**Whenever the vehicle is turned on, Inattentive Driving Warning will always turn on. (For Europe)**

## Leading vehicle departure alert

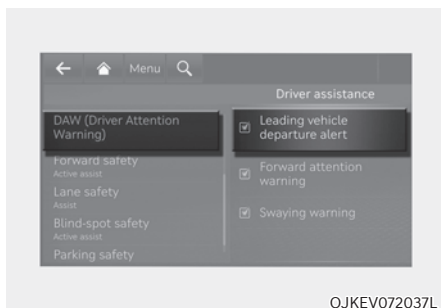

- If 'Leading vehicle departure alert' is selected, the function will inform the driver when a detected vehicle in front departs from a stop.

## Warning timing

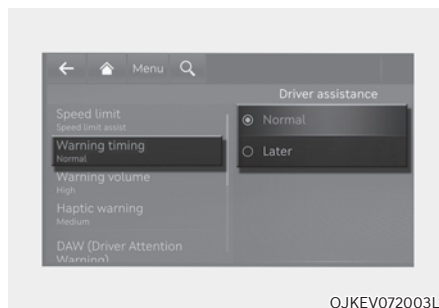

With the vehicle on, select 'Driver assistance → Warning timing' from the Settings menu to change the initial warning activation time for Driver Attention Warning. The warning time can be set to either 'Normal (Standard)' or 'Later'.

- Use 'Normal (Standard)' in normal driving conditions. If the Warning timing seems sensitive, change it to 'Later'.
- If 'Later' is selected, Driver Attention Warning, warns the driver more slowly.

### **i** Information

- **If you change the Warning timing, the Warning timing of other Driver Assistance systems may change.**
- **If the vehicle is restarted, Driver Attention Warning will maintain the last setting.**

## Driver Attention Warning operation

### Basic function

The basic function of Driver Attention Warning is to warn the driver 'Consider taking a break'.

### Taking a break

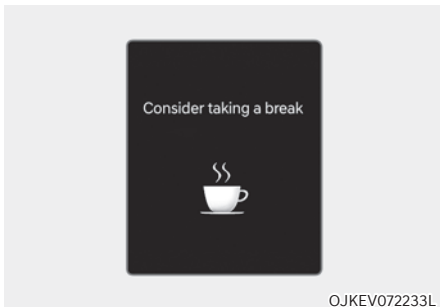

- The 'Consider taking a break' message will appear on the cluster and an audible warning will sound to suggest that the driver take a break, when the driver's attention level is below a certain level.
- Driver Attention Warning will not suggest a break when the total driving time is shorter than 10 minutes or 10 minutes has not passed after the last break was suggested.
- The 'Taking a brake' will operate when your vehicle speed is between approximately 0-200 km/h (0-124 mph)

### WARNING

For your safety, only change the Settings after parking the vehicle at a safe location.

### CAUTION

- Driver Attention Warning may suggest a break depending on the driver's driving pattern or habits, even if the driver doesn't feel fatigued.
- Driver Attention Warning is a supplemental function and may not be able to determine whether the driver is inattentive.
- A driver who feels fatigued should take a break at a safe location, even though there is no break suggestion by Driver Attention Warning.

### Information

- For more details on instrument cluster settings, refer to "LCD display control" section in chapter 4.

### Leading vehicle departure alert function

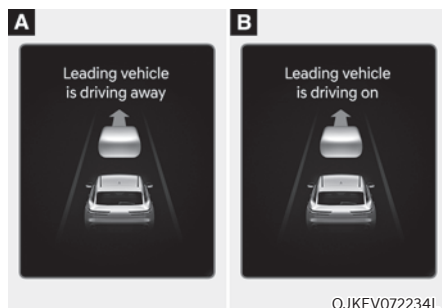

OJKEV072234L

When a detected vehicle in front departs from a stop, Leading Vehicle Departure Alert will inform the driver by displaying the 'Leading vehicle is driving away' (or 'Leading vehicle is driving on') message on the cluster and an audible warning will sound.

### WARNING

- **If any other system's warning message is displayed or audible warning is generated, Leading Vehicle Departure Alert's warning message may not be displayed and audible warning may not be generated.**
- **The driver has the responsibility to safely drive and control the vehicle.**

### CAUTION

- **Leading Vehicle Departure Alert is a supplemental function and may not alert the driver whenever the front vehicle departs from a stop.**
- **Always check the front of the vehicle and road conditions before departure.**

### Information

The images and colors in the instrument cluster may differ depending on the cluster type or theme selected from the settings menu.

### Driver Attention Warning malfunction and limitations

#### *Driver Attention Warning malfunction*

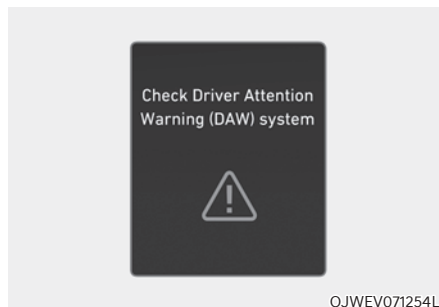

OJWEV071254L

When Driver Attention Warning is not working properly, the 'Check Driver Attention Warning (DAW) system' warning message will appear on the cluster for several seconds, and the master () warning light will illuminate on the cluster. If this occurs, we recommend that the vehicle be inspected by an authorized retailer of Genesis Branded products.

### Limitations of Driver Attention Warning

Driver Attention Warning may not work properly in the following situations:

- The vehicle is driven violently
- The vehicle intentionally crosses over lanes frequently
- The vehicle is controlled by Driver Assistance system, such as Lane Keeping Assist

### Leading vehicle departure alert function

- When the vehicle cuts in

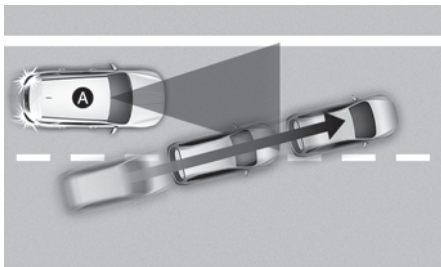

OJKEV072121L

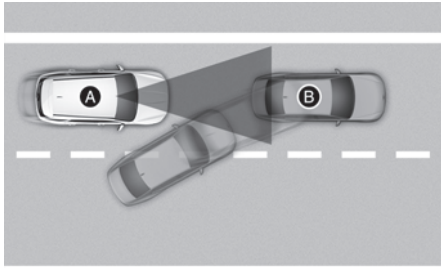

OJKEV072122L

[A]: Your vehicle, [B]: Front vehicle

If a vehicle cuts in front of your vehicle, Leading Departure Alert may not operate properly.

- When the vehicle ahead sharply steers

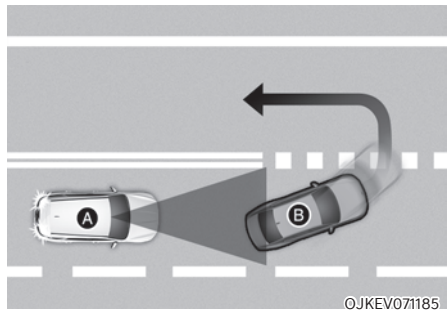

OJKEV071185

[A]: Your vehicle, [B]: Front vehicle

If the vehicle in front makes a sharp turn, such as to turn left or right or make a U-turn, etc., Leading Vehicle Departure Alert may not operate properly.

- When the vehicle ahead abruptly departs

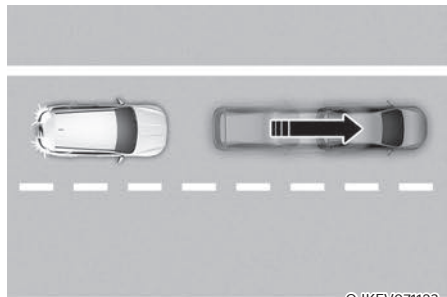

OJKEV071123

If the vehicle in front abruptly departs, Leading Vehicle Departure Alert may not operate properly.



- When a pedestrian or bicycle is between you and the vehicle ahead

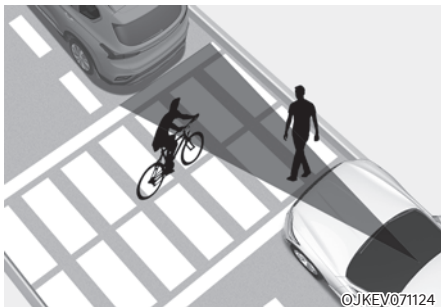

If there is a pedestrian(s) or bicycle(s) in between you and the vehicle in front, Leading Vehicle Departure Alert may not operate properly.

- When in a parking lot

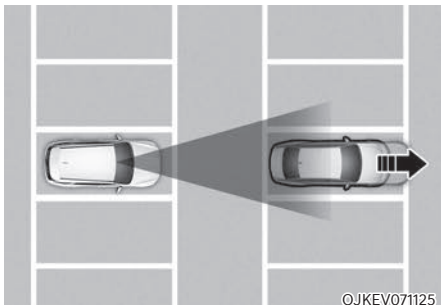

If a vehicle parked in front drives away from you, Leading Vehicle Departure Alert may alert you that the parked vehicle is driving away.

- When driving at a tollgate or intersection, etc.

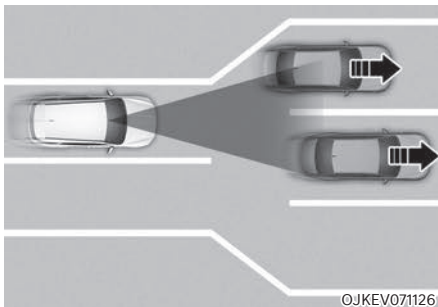

If you pass a tollgate or intersection with lots of vehicles or you drive where lanes are merged or divided frequently, Leading Vehicle Departure Alert may not operate properly.

### **i** Information

- For more details on the precautions of the front view camera, refer to “Forward Collision-Avoidance Assist (FCA)” section in this chapter.
- Driver Attention Warning may not operate for 15 seconds after the vehicle is started, or the front view camera is initialized.

## FORWARD ATTENTION WARNING (FAW) (IF EQUIPPED)

Forward Attention Warning can warn the driver to help prevent the driver from being distracted while using the interior view camera installed in the instrument cluster.

### Forward Attention Warning settings

#### Setting features

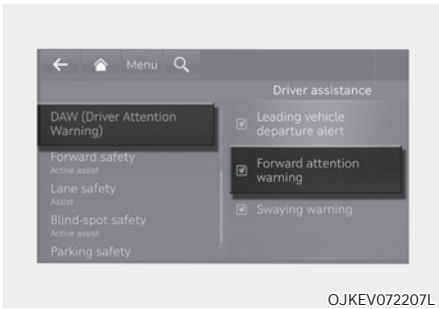

#### Forward Attention Warning

With the vehicle on, select 'Driver assistance → DAW (Driver Attention Warning) → Forward attention warning' from the Settings menu to turn on Forward Attention Warning and deselect to turn off the function.

#### WARNING

If the vehicle is restarted, Forward Attention Warning will maintain the last setting. If 'Off' is selected, the driver should always be aware of the surroundings and drive safely.



#### Warning timing

With the vehicle on, select 'Driver assistance → Warning timing' from the Settings menu to change the initial warning activation time for Forward Attention Warning.

When the vehicle is first delivered, Warning timing is set to 'Normal (Standard)'. If you change the Warning timing, the warning time of other Driver Assistance systems may change.

#### CAUTION

- Select 'Later' for Warning timing when traffic is light and when driving speed is slow.
- While Smart Cruise Control or Highway Driving Assist is operating, Forward Attention Warning may warn later than the set warning time.

#### CAUTION

The setting of the Warning timing applies to all functions of Forward Attention Warning.

## Forward Attention Warning operation

### Operating conditions

Forward Attention Warning will operate when the following conditions are satisfied:

- Vehicle speed is above 1 km/h (0.6 mph)
- The gear is in D (Drive) or N (Neutral)

### Forward Attention Warning

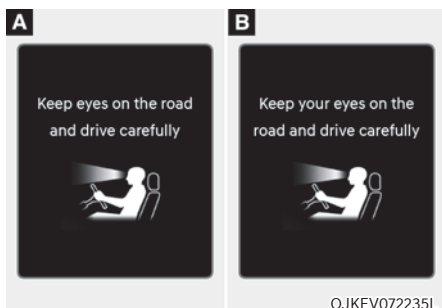

Forward Attention Warning determines whether the driver is focused on the road depending on information, such as the amount of time the driver is looking elsewhere, the amount of time the eyes are closed, how frequently the driver yawns, etc. If Forward Attention Warning judges the driver is not focused, the 'Keep your eyes on the road and drive carefully' (or 'Keep eyes on the road and drive carefully') warning message will appear on the cluster, and an audible warning will sound.

### WARNING

If any other system's warning message is displayed or audible warning is generated, Forward Attention Warning's warning message may not be displayed and audible warning may not be generated.

### CAUTION

- Forward Attention Warning may warn the driver even though the driver is focused on the road due to driving style and driving pattern.
- Forward Attention Warning is a supplemental function and may not be able to determine whether the driver is distracted while driving.
- The driver has the responsibility to safely drive and focus on the road.

### Information

Forward Attention Warning does not transmit recorded videos outside of the vehicle or store the video.

### **Forward Attention Warning malfunction and limitations** *Forward Attention Warning malfunction*



When Forward Attention Warning is not working properly, the 'Check forward attention warning system' warning message will appear on the cluster for several seconds, and the master  warning light will illuminate on the cluster. If this occurs, we recommend that the vehicle be inspected by an authorized retailer of Genesis Branded products.

### *Forward Attention Warning disabled*

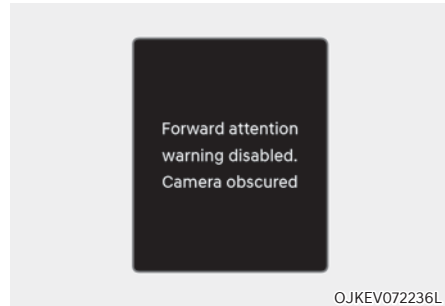

When there is an object right in front of the camera or between the driver and the camera for a certain period of time, Forward Attention Warning will not operate properly, and the 'Forward attention warning disabled. Camera obscured' warning message will appear on the cluster.

After the warning message appears, if the object is removed, or Forward Attention Warning is able to detect the driver's face, the function will operate properly.

 **CAUTION**

[A] : Interior view camera

- Do not impact the surface of the instrument cluster, camera or around the area of the camera. If the interior view camera is damaged, Forward Attention Warning may not work properly.
  - Do not place a mobile phone or an object in front of the camera. The surface of the instrument cluster or the camera might be damaged due to an impact while driving.
  - Do not place anything on the camera or in front of the camera while driving. The interior view camera may not operate properly.
  - If anything else is placed in front of the camera, Forward Attention Warning may not operate properly.
- When cleaning the instrument cluster or camera, wipe with a soft and clean cloth to prevent damages on the surface of the cluster or camera lens. In addition, you should not use sharp tools near the cluster or camera, or use chemicals to clean the cluster or camera.
  - Always keep the camera and around the area of the interior view camera clean and dry.
  - Do not apply foreign objects, such as a sticker, around the infrared LED located near the camera.
  - The 3D cluster may flicker when adjusting to the driver's eyes or when the instrument cluster's camera view is blocked by the steering wheel or other objects.

 **Information**

Two red lights may appear on the camera in the following conditions when:

- The outside brightness is dim or driving at night
- The vehicle drives inside a building, such as a basement parking lot, garage or tunnel
- The camera case of the instrument cluster is partially broken

 **WARNING**

Do not look toward the camera within 20 cm (8 in.) for longer than a minute.

### ***Limitations of Forward Attention Warning***

Forward Attention Warning may be limited or may not operate properly in the following circumstances:

- The driver is wearing sunglasses, special glasses, infrared cutoff glasses, refracting glasses or thick glasses
- The driver has heavy eye makeup (eyeliner, mascara, color makeup, false eyelash) or eye piercing
- The driver's view is blocked by his/her hair, hat, etc.
- The driver is winking or wearing an eye patch on one eye
- The driver's face is covered partially by a mask, muffler, etc.
- The driver's view is blocked by incoming light from outside of the vehicle
- Light from outside, sunlight or infrared LED light of the camera is reflected by glasses or sunglasses
- The driver turns or lowers his/her head so that the face or an eye is hidden from the camera
- The camera is out of the range to monitor or close within 20 cm (8 in.)
- The driver shakes his/her head up and down, or adverse road conditions cause excessive vehicle vibrations while driving
- The driver is improperly positioned in the driver's seat so that the driver's face is not detected
- The driver is too tall or short
- The camera is blocked by the adjusted steering wheel height or the turned steering wheel
- More than two people are looking at the instrument cluster simultaneously from the driver's seat
- The driver's eyes are narrowed due to laughing or sun glare
- Misrecognize a picture or mannequin that has a similar size of the driver's face
- There are other devices using infrared light in the vehicle

## BLIND-SPOT VIEW MONITOR (BVM) (IF EQUIPPED)

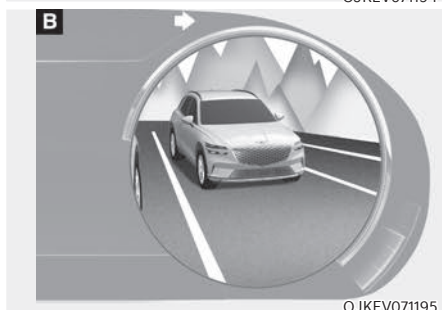
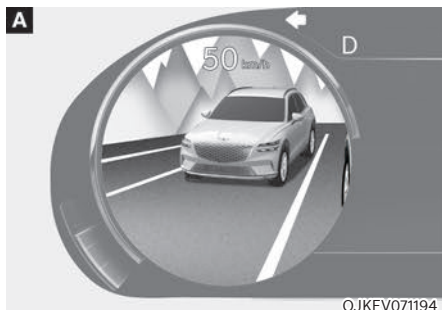

[A]: Left side, [B]: Right side

Blind-Spot View Monitor displays the rear blind spot area of the vehicle in the cluster when the turn signal is turned on to help safely change lanes.

### Detecting sensor

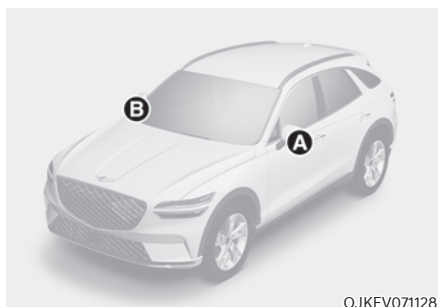

[A], [B]: Wide-side view camera

Refer to the picture above for the detailed location of the detecting sensors.

## Blind-Spot View Monitor settings

### Setting features

#### Blind-Spot View

With the vehicle on, select 'Driver assistance → Blind-spot safety → Blind-spot view' from the Settings menu to turn on Blind-Spot View Monitor and deselect to turn off the function.

## Blind-Spot View Monitor operation

### Operating switch

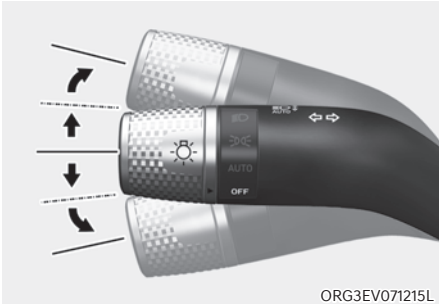

### Turn signal switch

Blind-Spot View Monitor will turn on and off when the turn signal is turned on and off.

## Blind-Spot View Monitor

### Operating conditions

When the left or right side turn signal turns on, the image in that direction is displayed on the instrument cluster.

### Off conditions

- When the turn signal turns off, the image on the instrument cluster will turn off.
- When the hazard warning flasher is on, Blind-Spot View Monitor will turn off, regardless of the turn signal status.
- When other important warning is displayed on the instrument cluster, Blind-Spot View Monitor may turn off.

## Blind-Spot View Monitor malfunction

When Blind-Spot View Monitor is not working properly, or the cluster display flickers, or the camera image does not display properly, we recommend that the vehicle be inspected by an authorized retailer of Genesis Brand products.



### WARNING

- The image shown on the cluster may differ from the actual distance of the object. Make sure to directly check the vehicle's surroundings for safety.
- Always keep the camera lens clean. If the lens is covered with foreign material, it may adversely affect camera performance and Blind-Spot View Monitor may not operate properly.



## SMART CRUISE CONTROL (SCC) (IF EQUIPPED)

Smart Cruise Control is designed to help detect the vehicle ahead and help maintain the desired speed and minimum distance between the vehicle ahead.

### Overtaking Acceleration Assist

While Smart Cruise Control is operating, if the function judges that the driver is determined to overtake the vehicle in front, acceleration will be assisted.

### Based on Driving Style (if equipped)

Smart Cruise Control will operate based on the driver's driving style, such as inter-vehicle distance, acceleration, reaction speed.

### Detecting sensor

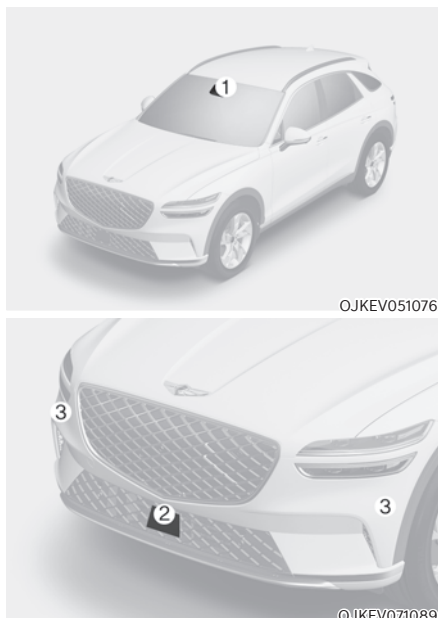

[1]: Front view camera, [2]: Front radar  
[3]: Front corner radar (if equipped)

The front view camera, front radar and front corner radar (if equipped) are used as a detecting sensor to detect front vehicles.

Refer to the picture above for the detailed location of the detecting sensor.



### CAUTION

**Always keep the front view camera and front radar in good condition to maintain optimal performance of Smart Cruise Control.**

**For more details on the precautions of the front view camera, front radar and front corner radar (if equipped), refer to “Forward Collision-Avoidance Assist (FCA)” section in this chapter.**

### Smart Cruise Control settings Smart Cruise Control

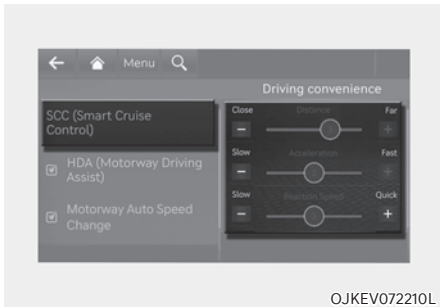

With the vehicle on, select 'Driver assistance → Driving convenience → SCC (Smart Cruise Control)' from the setting menu, to change Distance, Acceleration, Reaction Speed manually.

### Based on Driving Style (if equipped)

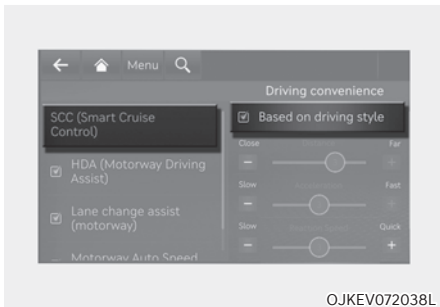

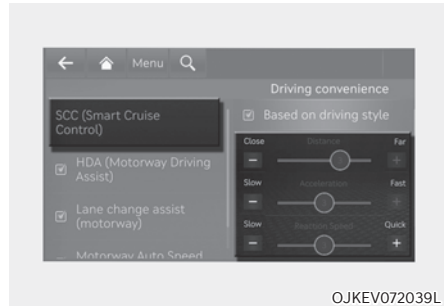

With the vehicle on, if 'Driver assistance → Driving convenience → SCC (Smart Cruise Control) → Based on driving style' is selected from the Settings menu, Smart Cruise Control will operate based on the driver's driving style, such as vehicle distance, acceleration, reaction speed.

### Driving Style settings (if equipped)



With the vehicle on, select 'Driver assistance → Driving convenience → SCC (Smart Cruise Control)' from the Settings menu to check the driver's driving style, and to change each driving style manually.

### **i** Information

- While Smart Cruise Control is operating with 'Based on Driving Style' selected, if you press and hold the Vehicle Distance () button, 'Based on Driving Style' will deactivate. If you press and hold the Vehicle Distance () button again, 'Driving Style Setting' will activate.
- Based on Driving Style setting continuously learns when the driver drives the vehicle.
- When Based on Driving Style is deactivated, the driver's driving style such as vehicle distance, acceleration, reaction speed will maintain in the same stage.
- Even if the steps of the driver's driving style such as vehicle distance, acceleration, reaction speed displayed when the Base on Driving Style is activated or deactivated are the same, the driving style to be controlled may be differently.

## Warning volume

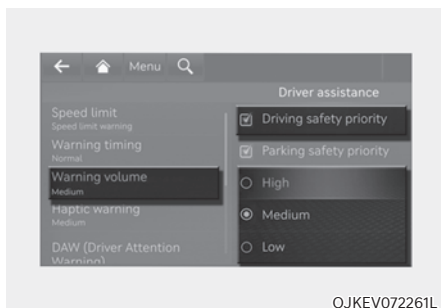

With the vehicle on, select 'Driver assistance → Warning volume' or 'Sound → Driver assistance → Warning volume' from the Settings menu to change the Warning volume 'High', 'Medium', 'Low' or 'Off' for Smart Cruise Control.

If 'Driving safety priority' is selected, the vehicle lowers all other audio volumes when the warning sounds for safe driving.

### **i** Information

- If the vehicle is restarted, **Warning volume will maintain the last setting.**
- If 'Off' is selected, **steering wheel vibration will not turn off.**
- If you change the **Warning volume, the Warning volume of other Driver Assistance systems may change.**

## Smart Cruise Control operation

### *Operating conditions for basic function*

#### Basic function

Smart Cruise Control operates when the following conditions are satisfied.

- The gear is in D (Drive)
- Your vehicle speed is within the operating speed range
  - 10-200 km/h (5-120 mph): when there is no vehicle in front
  - 0-200 km/h (0-120 mph): when there is a vehicle in front
- ESC (Electronic Stability Control) or ABS (Anti-Lock Braking System) is on

Smart Cruise Control does not operate in the following conditions.

- The driver's door is opened
- Your vehicle is in power down mode (Ⓜ)
- EPB (Electronic Parking Brake) is applied
- ESC (Electronic Stability Control) or ABS (Anti-Lock Braking System) is controlling the vehicle
- Forward Collision-Avoidance Assist brake control is operating
- Remote Smart Parking Assist brake control is operating (if equipped)
- Hands-off warning for Lane Keeping Assist and Highway Driving Assist is on

### **i** Information

**When stopped behind another vehicle, the driver can turn on Smart Cruise Control while the brake pedal is depressed.**

### Operating conditions for Acceleration Assist

Overtaking Acceleration Assist operates when the turn signal indicator is turned on to the left (left-hand drive) or turned on to the right (right-hand drive) while Smart Cruise Control is operating, and the following conditions are satisfied:

- Your vehicle speed is above 60 km/h (40 mph)
- A vehicle is detected in front of your vehicle

Overtaking Acceleration Assist does not operate in the following conditions.

- The hazard warning flasher is on
- Vehicle speed is reduced to maintain distance with the vehicle in front

#### **WARNING**

- **When the turn signal indicator is turned on to the left (left-hand drive) or turned on to the right (right-hand drive) while there is a vehicle ahead, the vehicle may accelerate temporarily. Pay attention to the road conditions at all times.**
- **Regardless of the driving direction in your country, Overtaking Acceleration Assist will operate when the conditions are satisfied. When using the function in countries with different driving direction, always check the road conditions at all times.**

### Turning on Smart Cruise Control



- Press the Driving Assist button to turn on Smart Cruise Control. The speed will be set to the current speed on the cluster.
- If there is no vehicle in front of you, the set speed will be maintained, but if there is a vehicle in front of you, the speed may decrease to maintain the distance to the vehicle ahead. If the vehicle ahead accelerates, your vehicle will travel at a steady cruising speed after accelerating to the set speed.

#### **Information**

**If your vehicle speed is between 0-30 km/h (0-20 mph) when you press the Driving Assist button, the Smart Cruise Control speed will be set to 30 km/h (20 mph).**

### Setting vehicle distance



Each time the button is pressed, the headway changes as follows:

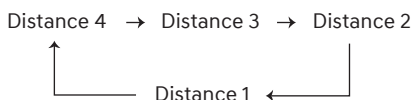

#### **i** Information

- If you drive at 90 km/h (56 mph), the distance is maintained as follows:
  - Distance 4 - approximately 53 m (172 ft.)
  - Distance 3 - approximately 40 m (130 ft.)
  - Distance 2 - approximately 30 m (106 ft.)
  - Distance 1 - approximately 25 m (82 ft.)
- The distance is set to the last set distance when the vehicle is restarted, or when Smart Cruise Control was temporarily cancelled.

### Increasing set speed



- Push the + switch up and release it immediately. The set speed will increase by 1 km/h (1 mph) each time the switch is operated in this manner.
- Push the + switch up and hold it while monitoring the set speed on the cluster. The set speed will increase by 10 km/h (5 mph) each time the switch is operated in this manner. Release the switch when the desired speed is shown, and the vehicle will accelerate to that speed. You can increase the set speed to 200 km/h (120 mph).

#### **⚠** WARNING

Check the driving condition before using the + switch. Driving speed may sharply increase when you push up and hold the + switch.

### Decreasing set speed



- Push the - switch down and release it immediately. The set speed will decrease by 1 km/h (1 mph) each time the switch is operated in this manner.
- Push the - switch down and hold it while monitoring the set speed on the cluster. The set speed will decrease by 10 km/h (5 mph) each time the switch is operated in this manner.

Release the switch at the speed you want to maintain. You can decrease the set speed to 30 km/h (20 mph).

### Temporarily cancelling Smart Cruise Control

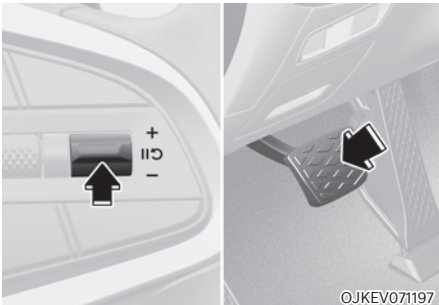

Press the  switch or depress the brake pedal to temporarily cancel Smart Cruise Control.

### Resuming Smart Cruise Control

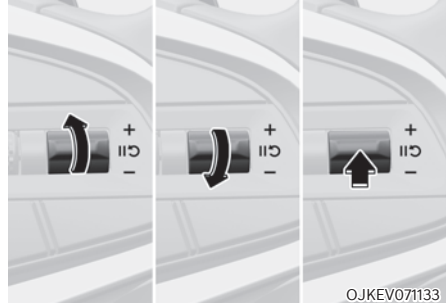



To resume Smart Cruise Control after the function was cancelled, operate the +, - or  switch.

If you push the + switch up or - switch down, the set speed will be set to the current speed on the cluster.

If you press the  switch, vehicle speed will resume to the preset speed.

### WARNING

**Check the driving condition before using the  switch. Driving speed may sharply increase or decrease when you press the  switch.**

### Turning off Smart Cruise Control



OJKEV071118

Press the Driving Assist button to turn Smart Cruise Control off.



#### Information

If your vehicle is equipped with Manual Speed Limit Assist, press and hold the Driving Assist button to turn off Smart Cruise Control. However Manual Speed Limit Assist will turn on.



#### CAUTION

Do not use the switches and buttons at the same time. Smart Cruise Control may not operate properly.

### Displaying operating status

You can see the status of the Smart Cruise Control operation in the Driving Assist view on the cluster. Refer to “View Modes” section in chapter 4.

Smart Cruise Control will be displayed as below depending on the status of the function.

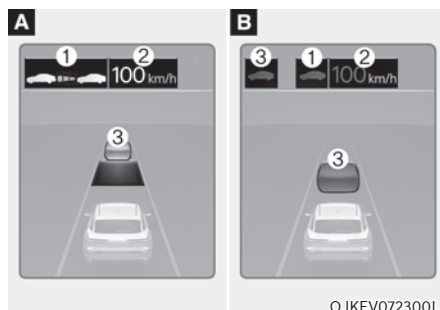

OJKEV072300L

[A]: Operating, [B]: Temporarily cancelled

- When operating
  - (1) Whether there is a vehicle ahead and the selected distance level
  - (2) Set speed
  - (3) Whether there is a vehicle ahead and the target vehicle distance
  
- When temporarily cancelled
  - (1) Your vehicle (shaded)
  - (2) Previous set speed (shaded)
  - (3) Vehicle ahead and distance level (shaded) (if equipped)

**i** Information

- The distance of the front vehicle on the cluster is displayed according to the actual distance between your vehicle and the vehicle ahead.
- The target distance may vary according to the vehicle speed and the set distance level. If the vehicle speed is low, even though the vehicle distance have changed, the change of the target vehicle distance may be small.
- The images and colors in the instrument cluster may differ depending on the cluster type or theme selected from the settings menu.

**Accelerating temporarily**



If you want to speed up temporarily without altering the set speed while Smart Cruise Control is operating, depress the accelerator pedal. While the accelerator pedal is depressed, the set speed, distance level and target distance will blink on the cluster.

However, if the accelerator pedal is depressed insufficiently, the vehicle may decelerate.

**⚠** WARNING

Be careful when accelerating temporarily, because the speed and distance is not controlled automatically even if there is a vehicle in front of you.

**Based on Driving Style operation**

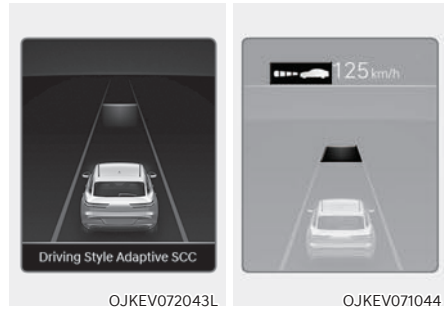

When Based on Driving Style is operating, 'Driving Style Adaptive SCC' message will appear on the cluster for 2 seconds, and the distance level and target distance will be displayed based on the driving style.



### Temporarily cancelling Smart Cruise Control

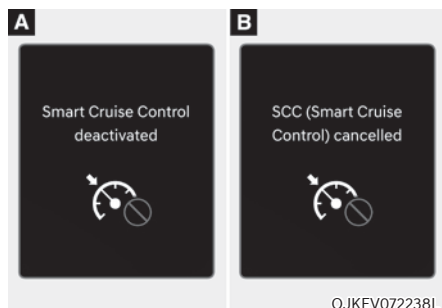

Smart Cruise Control will be temporarily cancelled automatically when:

- The vehicle speed is above 210 km/h (130 mph)
- The vehicle is stopped for a certain period of time
- The accelerator pedal is continuously depressed for a certain period of time
- The conditions for the Smart Cruise Control to operate is not satisfied

If Smart Cruise Control is temporarily cancelled automatically, the 'Smart Cruise Control deactivated' (or 'SCC (Smart Cruise Control) cancelled') warning message will appear on the cluster, and an audible warning will sound to warn the driver.

### **i** Information

**If Smart Cruise Control is temporarily cancelled while the vehicle is at a standstill with the function activated, EPB (Electronic Parking Brake) maybe applied.**

### **⚠** WARNING

When Smart Cruise Control is temporarily cancelled, distance with the front vehicle will not be maintained. Always have your eyes on the road while driving, and if necessary, depress the brake pedal to reduce your driving speed in order to maintain a safe distance.

### Smart Cruise Control conditions not satisfied

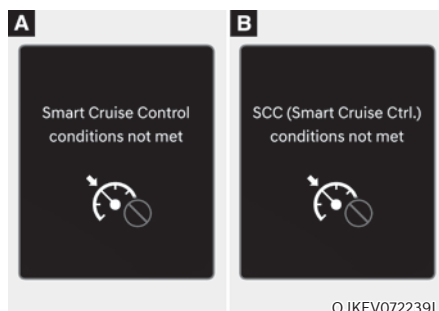

If the Driving Assist button, + switch, - switch or  switch is operated when Smart Cruise Control operating conditions are not satisfied, the 'Smart Cruise Control conditions not met' (or 'SCC (Smart Cruise Ctrl.) conditions not met') will appear on the cluster, and an audible warning will sound.

### In traffic situation



In traffic, your vehicle will stop if the vehicle ahead of you stops. Also, if the vehicle ahead of you starts moving, your vehicle will start as well. In addition, after the vehicle has stopped and a certain time have passed, the 'Use switch or pedal to accelerate' message will appear on the cluster. Depress the accelerator pedal or operate the + switch, - switch or  switch to start driving.

### Warning road conditions ahead

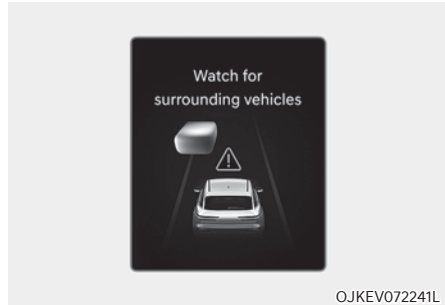

In the following situation, the 'Watch for surrounding vehicles' warning message will appear on the cluster, and an audible warning will sound to warn the driver of road conditions ahead.

- The vehicle in front disappears when Smart Cruise Control is maintaining the distance with the vehicle ahead while driving below a certain speed.

### **WARNING**

**Always pay attention to vehicles or objects that may suddenly appear in front of you, and if necessary, depress the brake pedal to reduce your driving speed in order to maintain a safe distance.**

### Collision warning

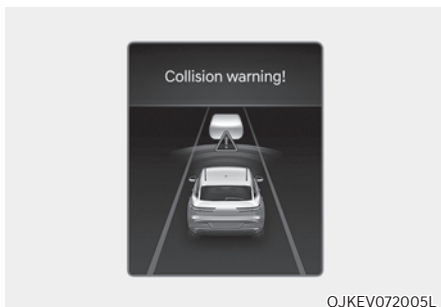

While Smart Cruise Control is operating, when the collision risk with the vehicle ahead is high, the 'Collision warning!' warning message will appear on the cluster, and an audible warning will sound to warn the driver. Always have your eyes on the road while driving, and if necessary, depress the brake pedal to reduce your driving speed in order to maintain a safe distance.

### WARNING

In the following situations, Smart Cruise Control may not warn the driver of a collision.

- The distance from the front vehicle is near, or the vehicle speed of the front vehicle is faster or similar to your vehicle
- The speed of the front vehicle is very slow or is at a standstill
- The accelerator pedal is depressed right after Smart Cruise Control is turned on

### WARNING

Take the following precautions when using Smart Cruise Control:

- Smart Cruise Control does not substitute for proper and safe driving. It is the responsibility of the driver to always check the speed and distance to the vehicle ahead.
- Smart Cruise Control may not recognize unexpected and sudden situations or complex driving situations, so always pay attention to driving conditions and control your vehicle speed.
- Keep Smart Cruise Control off when the function is not in use to avoid inadvertently setting a speed.
- Do not open the door or leave the vehicle when Smart Cruise Control is operating, even if the vehicle is stopped.
- Always be aware of the selected speed and headway distance.
- Keep a safe distance according to road conditions and vehicle speed. If the headway distance is too close during high-speed driving, a serious collision may result.

- When maintaining distance with the vehicle ahead, if the front vehicle disappears, Smart Cruise Control may suddenly accelerate to the set speed. Always be aware of unexpected and sudden situations from occurring.
- Vehicle speed may decrease on an upward slope and increase on a downward slope.
- Always be aware of situations such as when a vehicle cuts in suddenly.
- When you are towing a trailer or another vehicle, turn off Smart Cruise Control for safety reasons.
- Turn off Smart Cruise Control when your vehicle is being towed.
- Smart Cruise Control may not operate properly if interfered by strong electromagnetic waves.
- Smart Cruise Control may not detect an obstacle in front and lead to a collision. Always look ahead cautiously to prevent unexpected and sudden situations from occurring.
- Vehicles moving in front of you with a frequent lane change may cause a delay in Smart Cruise Control reaction or may cause Smart Cruise Control to react to a vehicle actually in an adjacent lane. Always drive cautiously to prevent unexpected and sudden situations from occurring.
- Always be aware of the surroundings and drive safely, even though a warning message does not appear or an audible warning does not sound.
- If any other system's warning message is displayed or warning sound is generated, Smart Cruise Control warning message may not be displayed and warning sound may not be generated.
- You may not hear the warning sound of Forward Collision-Avoidance Assist if the surrounding is noisy.
- The vehicle manufacturer is not responsible for any traffic violation or accidents caused by the driver.
- Always set the vehicle speed under the speed limit in your area.
- Vehicle distance, acceleration and reaction speed may change if the driver's driving style changes.

### CAUTION

- The vehicle must be driven sufficiently to reflect the actual driving style of the driver, such as inter-vehicle distance, acceleration and reaction speed.
- Based on Driving style does not reflect whether the driver has changed when determining the driver's driving style.
- If you are driving in special conditions, such as snow, rain, fog or steep slopes, the vehicle may not be driven according to the driver's driving style.

### Information

- Smart Cruise Control may not operate for 15 seconds after the vehicle is started or the front view camera or front radar is initialized.
- You may hear a sound when the brake is controlled by Smart Cruise Control.
- Based on Driving Style may not reflect the driver's driving style or driving conditions that affects driving safety.
- Based on Driving Style does not reflect any other driving style other than inter-vehicle distance, acceleration and reaction speed.

### Smart Cruise Control malfunction and limitations

#### Smart Cruise Control malfunction

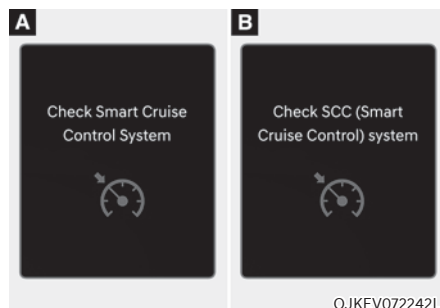

When Smart Cruise Control is not working properly, the 'Check Smart Cruise Control System' (or 'Check SCC (Smart Cruise Control) system') warning message will appear, and the  warning light will illuminate on the cluster. If this occurs, we recommend that the vehicle be inspected by an authorized retailer of Genesis Branded products.

### Smart Cruise Control disabled

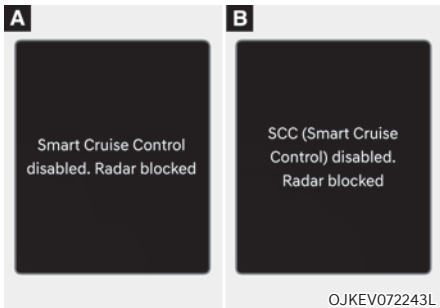

When the front radar cover or sensor is covered with snow, rain, or foreign material, it can reduce the detecting performance and temporarily limit or disable Smart Cruise Control.

If this occurs the 'Smart Cruise Control disabled. Radar blocked' (or 'SCC (Smart Cruise Control) disabled. Radar blocked') warning message will appear for a certain period of time on the cluster.

Smart Cruise Control will operate properly when snow, rain or foreign material is removed.



#### **WARNING**

**Even though the warning message does not appear on the cluster, Smart Cruise Control may not properly operate.**



#### **CAUTION**

**Smart Cruise Control may not properly operate in an area (for example, open terrain), where any objects are not detected after turning ON the vehicle.**

### Limitations of Smart Cruise Control

Smart Cruise Control may not operate properly, or it may operate unexpectedly under the following circumstances:

- The detecting sensor or the surroundings are contaminated or damaged
- Washer fluid is continuously sprayed, or the wiper is on
- The camera lens is contaminated due to tinted, filmed or coated windshield, damaged glass, or sticky foreign material (sticker, bug, etc.) on the glass
- Moisture is not removed or frozen on the windshield
- The field of view of the front view camera is obstructed by sun glare
- Street light or light from an oncoming vehicle is reflected on the wet road surface, such as a puddle on the road
- The temperature around the front view camera is high or low
- An object is placed on the dashboard
- The surrounding is very bright
- The surrounding is very dark, such as in a tunnel, etc.
- The brightness changes suddenly, for example when entering or exiting a tunnel
- The brightness outside is low, and the headlamps are not on or are not bright
- Driving in heavy rain or snow, or thick fog
- Driving through steam, smoke or shadow

- Only part of the vehicle is detected
- The vehicle in front has no tail lights, tail lights are located unusually, etc.
- The brightness outside is low, and the tail lamps are not on or are not bright
- The rear of the front vehicle is small or does not look normal (for example, tilted, overturned, etc.)
- The front vehicle's ground clearance is low or high
- A vehicle suddenly cuts in front
- Your vehicle is being towed
- Driving through a tunnel or iron bridge
- Driving near areas containing metal substances, such as a construction zone, railroad, etc.
- An object reflecting off the front radar such as a guardrail, nearby vehicle, etc.
- The bumper around the front radar is impacted, damaged or the front radar is out of position
- The temperature around the front radar is high or low
- Driving in vast areas where there are few vehicles or structures (for example, desert, meadow, suburb, etc.)
- The vehicle in front is made of material that does not reflect on the front radar
- Driving near a highway (or motorway) interchange or tollgate
- Driving on a slippery surface due to snow, water puddle, ice, etc.
- Driving on a curved road
- The vehicle in front is detected late
- The vehicle in front is suddenly blocked by an obstacle
- The vehicle in front suddenly changes lane or suddenly reduces speed
- The vehicle in front is bent out of shape
- The front vehicle's speed is fast or slow
- With a vehicle in front, your vehicle changes lane at low speed
- The vehicle in front is covered with snow
- Unstable driving
- You are on a roundabout and the vehicle in front is not detected
- You are continuously driving in a circle
- Driving in a parking lot
- Driving through a construction area, unpaved road, partial paved road, uneven road, speed bumps, etc.
- Driving on an incline road, curved road, etc.
- Driving through a roadside with trees or streetlights
- The adverse road conditions cause excessive vehicle vibrations while driving
- Your vehicle height is low or high due to heavy loads, abnormal tire pressure, etc.
- Driving through a narrow road where trees or grass are overgrown
- There is interference by electromagnetic waves, such as driving in an area with strong radio waves or electrical noise

- Driving on a curved road



On curves, Smart Cruise Control may not detect a vehicle in the same lane, and may accelerate to the set speed. Also, vehicle speed may rapidly decrease when the vehicle ahead is detected suddenly.

Select the appropriate set speed on curves and apply the brake pedal or accelerator pedal according to the road and driving conditions ahead.



Your vehicle speed can be reduced due to a vehicle in the adjacent lane.

Apply the accelerator pedal and select the appropriate set speed. Check to be sure that the road conditions permit safe operation of the Smart Cruise Control.

- Driving on an inclined road



During uphill or downhill driving, the Smart Cruise Control may not detect a moving vehicle in your lane, and cause your vehicle to accelerate to the set speed. Also, vehicle speed will rapidly decrease when the vehicle ahead is detected suddenly.

Select the appropriate set speed on inclines and apply the brake pedal or accelerator pedal according to the road and driving conditions ahead.



- Changing lanes



[A]: Your vehicle, [B]: Lane changing vehicle

When a vehicle moves into your lane from an adjacent lane, it cannot be detected by the sensor until it is in the sensor's detection range. Smart Cruise Control may not immediately detect the vehicle when the vehicle changes lanes abruptly. In this case, you must maintain a safe braking distance, and if necessary, depress the brake pedal to reduce your driving speed in order to maintain a safe distance.

- Situations when detecting are limited

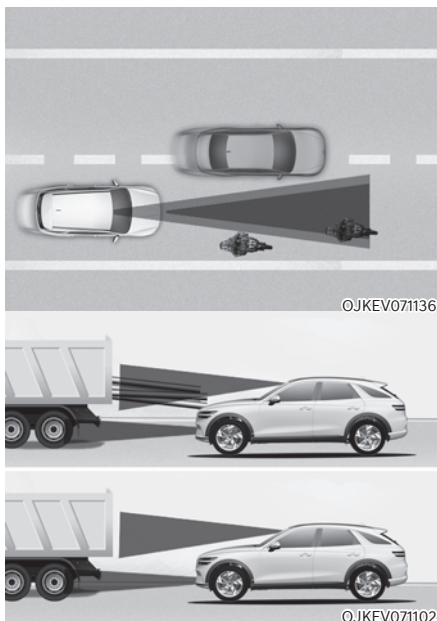

In the following cases, some vehicles, pedestrians or animals in your lane cannot be detected by the sensor:

- Vehicles offset to one side
- Slow-moving vehicles or sudden-decelerating vehicles
- Vehicles with higher ground clearance or vehicles carrying loads that stick out of the back of the vehicle
- Vehicles that has the front lifted due to heavy loads
- Vehicles within approximately 2 m (6 ft.) from your vehicle
- Oncoming vehicles
- Stopped vehicles
- Vehicles with small rear profile, such as trailers

- Narrow vehicles, such as motorcycles or bicycles
- Special vehicles
- Animals and pedestrians

Adjust your vehicle speed by depressing the brake pedal according to the road and driving conditions ahead.

In the following cases, the vehicle in front cannot be detected by the sensor:

- You are steering your vehicle
- Driving on narrow or sharply curved roads

Adjust your vehicle speed by depressing the brake pedal according to the road and driving conditions ahead.

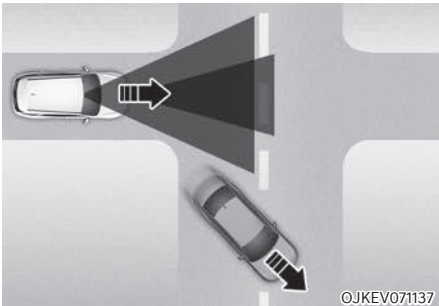

- When a vehicle ahead disappears at an intersection, your vehicle may accelerate.

Always pay attention to road and driving conditions while driving.

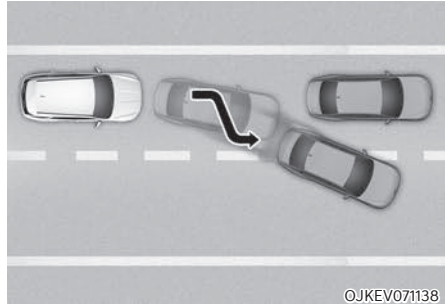

- When a vehicle in front of you merges out of the lane, Smart Cruise Control may not immediately detect the new vehicle that is now in front of you. Always pay attention to road and driving conditions while driving.

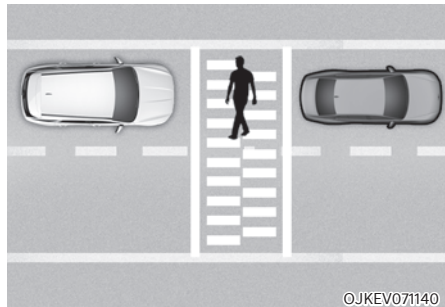

- Always look out for pedestrians when your vehicle is maintaining a distance with the vehicle ahead.

## NAVIGATION-BASED SMART CRUISE CONTROL (NSCC) (IF EQUIPPED)

Navigation-based Smart Cruise Control can help drive at a certain speed according to the road conditions when driving on highways (or motorways) by using road information from the navigation system while Smart Cruise Control is operating.

### **i** Information

- **Navigation-based Smart Cruise Control is available only on controlled access road of certain highways.**
  - \* **Controlled access road indicates roads with limited entrances and exits that allow uninterrupted high speed traffic flow. Only passenger cars and motorcycles are allowed on controlled access roads.**
- **Additional highways may be expanded by future navigation updates.**

### **i** Information

Navigation-based Smart Cruise Control operates on main roads of highways (or motorways), and does not operate on interchanges or junctions.

#### Highway Curve Zone Auto Slowdown

If vehicle speed is high, Highway Curve Zone Auto Slowdown function will temporarily decelerate your vehicle or limit acceleration to help you drive safely on a curve based on the curve information from the navigation.

#### Highway Set Speed Auto Change

Highway Set Speed Auto Change function automatically changes Smart Cruise Control set speed based on the speed limit information from the navigation.

## Navigation-based Smart Cruise Control settings

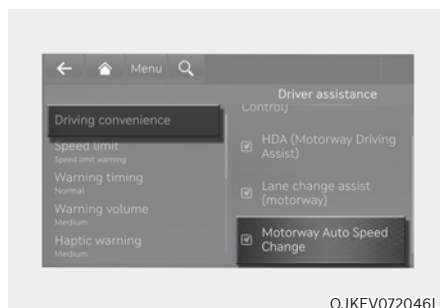

OJKEV072046L

With the vehicle on, select 'Driver assistance → Driving convenience → Motorway Auto Speed Change (Highway Auto Speed Change)' from the Settings menu to turn on Navigation-based Smart Cruise Control and deselect to turn off the function.

### **i** Information

**When there is a problem with Navigation-based Smart Cruise Control, the function cannot be set from the Settings menu.**

## Navigation-based Smart Cruise Control operation

### Operating conditions

Navigation-based Smart Cruise Control is ready to operate if all of the following conditions are satisfied:

- Smart Cruise Control is operating
- Driving on main roads of highways (or motorways)

### Information

For more details on how to operate Smart Cruise Control, refer to “Smart Cruise Control (SCC)” section in this chapter.

### Navigation-based Smart Cruise Control display and control

When Navigation-based Smart Cruise Control operates, it will be displayed on the cluster as follows:



### Navigation-based Smart Cruise Control standby

If the operating conditions are satisfied, the white **NAV** symbol will illuminate.



### Navigation-based Smart Cruise Control operating

If temporary deceleration is required in the standby state and Navigation-based Smart Cruise Control is operating, the green **NAV** symbol will illuminate on the cluster.

If the Highway Set Speed Auto Change function operates, the **NAV** symbol and set speed will illuminate in green on the cluster, and an audible warning will sound.

## WARNING



**'Drive carefully' warning message will appear in the following circumstances:**

- **Navigation-based Smart Cruise Control is not able to slow down your vehicle to a safe speed**

## Information



- **Highway Curve Zone Auto Slowdown and Highway Set Speed Auto Change function uses the same **NAV** symbol.**
- **The images and colors in the instrument cluster may differ depending on the cluster type or theme selected from the settings menu.**

### Highway Curve Zone Auto Slowdown

- Depending on the curve ahead on the highway (or motorway), the vehicle will decelerate, and after passing the curve, the vehicle will accelerate to Smart Cruise Control set speed.
- Vehicle deceleration time may differ depending on the vehicle speed and the degree of the curve on the road. The higher the driving speed, deceleration will start faster.

### Highway Set Speed Auto Change

- Highway Set Speed Auto Change function will operate when Smart Cruise Control set speed and the highway (or motorway) speed limit is matched.
- While Highway Set Speed Auto Change function is operating, when the highway (or motorway), speed limit changes, Smart Cruise Control set speed automatically changes to the changed speed limit.
- If Smart Cruise Control set speed is adjusted different from the speed limit, Highway Set Speed Auto Change function will be in the standby state.
- If Highway Set Speed Auto Change function has changed to the standby state by driving on a road other than the highway (or motorway) main road, Highway Set Speed Auto Change function will operate again when you drive on the main road again without setting the set speed.

- If Highway Set Speed Auto Change function has changed to the standby state by depressing the brake pedal or pressing the  switch on the steering wheel, press the  switch to restart the function.
- Highway Set Speed Auto Change function does not operate on highway interchanges or junctions.

 **Information**

- **Highway Set Speed Auto Change function only operates based on the speed limits of the highway (or motorway), it does not work with the speed cameras.**
- **When Highway Set Speed Auto Change function is operating, the vehicle automatically accelerates or decelerates when the highway (or motorway) speed limit changes.**
- **The maximum set speed for Highway Set Speed Auto Change function is 140 km/h (86 mph).**
- **If the speed limit of a new road is not updated in the navigation, Highway Set Speed Auto Change function may not operate properly.**
- **If the speed unit is set to a unit other than the speed unit used in your country, Highway Set Speed Auto Change function may not operate properly.**

**Limitations of Navigation-based Smart Cruise Control**

Navigation-based Smart Cruise Control may not operate properly under the following circumstances:

- The navigation is not working properly
- Map information is not transmitted due to infotainment system's abnormal operation
- Speed limit and road information in the navigation is not updated
- The map information and the actual road is different because of real-time GPS data or map information error
- The navigation searches for a route while driving
- GPS signals are blocked in areas such as a tunnel
- A road that divides into two or more roads and joins again

- The driver goes off course the route set in the navigation
- The route to the destination is changed or cancelled by resetting the navigation
- The vehicle enters a service station or rest area
- Android Auto or Car Play is operating
- The navigation cannot detect the current vehicle position (for example, elevated roads including overpass adjacent to general roads or nearby roads exist in a parallel way)
- The navigation is being updated while driving
- The navigation is being restarted while driving
- The speed limit of some sections changes according to the road situations
- Driving on a road under construction
- Driving on a road that is controlled
- There is bad weather, such as heavy rain, heavy snow, etc.
- Driving on a road that is sharply curved

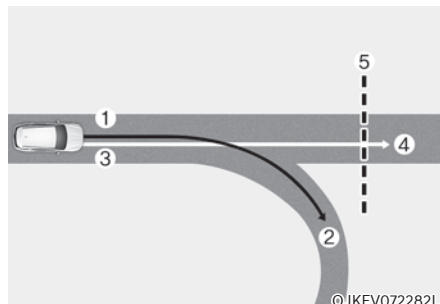

[1]: Set route, [2]: Branch line, [3]: Driving route, [4]: Main road, [5]: Curved road section

- When there is a difference between the navigation set route (branch line) and the driving route (main road), Highway Curve Zone Auto Slowdown function may not operate until the driving route is recognized as the main road.
- When the vehicle's driving route is recognized as the main road by maintaining the main road instead of the navigation set route, Highway Curve Zone Auto Slowdown function will operate. Depending on the distance to the curve and the current vehicle speed, vehicle deceleration may not be sufficient or may decelerate rapidly.

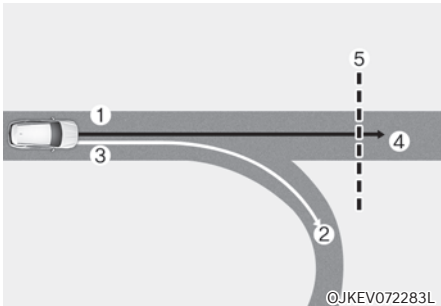

[1]: Set route, [2]: Branch line, [3]: Driving route, [4]: Main road, [5]: Curved road section

- When there is a difference between the navigation route (main road) and the driving route (branch line), Highway Curve Zone Auto Slowdown function will operate based on the curve information on the main road.
- When it is judged that you are driving out of the route by entering the highway interchange or junction, Highway Curve Zone Auto Slowdown function will not operate.

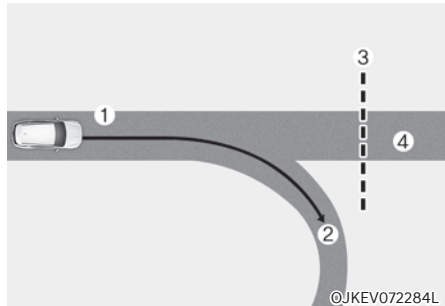

[1]: Driving route, [2]: Branch line, [3]: Curved road section, [4]: Main road

- If there is no destination set on the navigation, Highway Curve Zone Auto Slowdown function will operate based on the curve information on the main road.
- Even if you depart from the main road, Highway Curve Zone Auto Slowdown function may temporarily operate due to navigation information of the highway curve section.





## WARNING

- Navigation-based Smart Cruise Control is not a substitute for safe driving practices, but a convenience function. Always have your eyes on the road, and it is the responsibility of the driver to avoid violating traffic laws.
- The navigation's speed limit information may differ from the actual speed limit information on the road. It is the driver's responsibility to check the speed limit on the actual driving road or lane.
- Navigation-based Smart Cruise Control will automatically be cancelled when you leave the highway (or motorway) main road. Always pay attention to road and driving conditions while driving.
- Navigation-based Smart Cruise Control may not operate due to the existence of leading vehicles and the driving conditions of the vehicle. Always pay attention to road and driving conditions while driving.
- When you are towing a trailer or another vehicle, turn off Navigation-based Smart Cruise Control for safety reasons.
- After you pass through a tollgate on a highway (or motorway), Navigation-based Smart Cruise Control will operate based on the first lane. If you enter one of the other lanes, Navigation-based Smart Cruise Control might not operate properly.
- The vehicle will accelerate if the driver depresses the accelerator pedal while Navigation-based Smart Cruise Control is operating, and the function will not decelerate the vehicle. However, if the accelerator pedal is depressed insufficiently, the vehicle may decelerate.
- If the driver accelerates and releases the accelerator pedal while Navigation-based Smart Cruise Control is operating, the vehicle may not decelerate sufficiently or may rapidly decelerate to a safe speed.
- If the curve is too large or too small, Navigation-based Smart Cruise Control may not operate.



## Information

- A time gap could occur between the navigation's guidance and when Navigation-based Smart Cruise Control operation starts and ends.
- The speed information on the cluster and navigation may differ.
- Even if you are driving at a speed lower than Smart Cruise Control set speed, acceleration may be limited by the curve sections ahead.
- If Navigation-based Smart Cruise Control is operating while leaving the main road to enter an interchange, junction, rest area, etc., the function may operate for a certain period of time.
- Deceleration by Navigation-based Smart Cruise Control may feel it is not sufficient due to road conditions such as uneven road surfaces, narrow lanes, etc.

## LANE FOLLOWING ASSIST (LFA) (IF EQUIPPED)

Lane Following Assist is designed to help detect lane markings and/or vehicles on the road, and assists the driver's steering to help center the vehicle in the lane.

### Detecting sensor



OJKEV051076

[1]: Front view camera

The front view camera is used as a detecting sensor to detect lane markings and front vehicles.

Refer to the picture above for the detailed location of the detecting sensor.



### CAUTION

For more details on the precautions of the front view camera, refer to “Forward Collision-Avoidance Assist (FCA)” section in this chapter.

## Lane Following Assist settings

### Warning volume

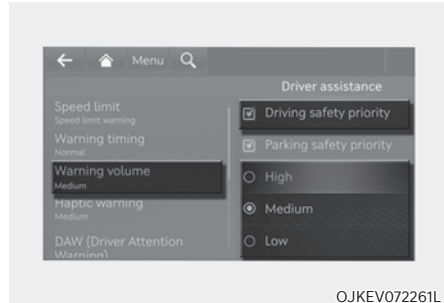

OJKEV072261L

With the vehicle on, select 'Driver assistance → Warning volume' or 'Sound → Driver assistance → warning volume' from the Settings menu to change the Warning Volume to 'High', 'Medium', 'Low' or 'Off' for Hands-off warning.

If 'Driving safety priority' is selected, the vehicle lowers all other audio volumes when the warning sounds for safe driving.



### Information

- If 'Off' is selected, the Hands-off Warning volume will not turn off, but the volume will sound as 'Low'.
- If you change the Warning volume, the Warning volume of other Driver Assistance systems may change.

## Lane Following Assist operation

### Turning Lane Following Assist On/Off



OJKEV071144

With the vehicle on, shortly press the Lane Driving Assist button located on the steering wheel to turn on Lane Following Assist. The grey or green  indicator light will illuminate on the cluster.

Press the button again to turn off the function.

## Lane Following Assist

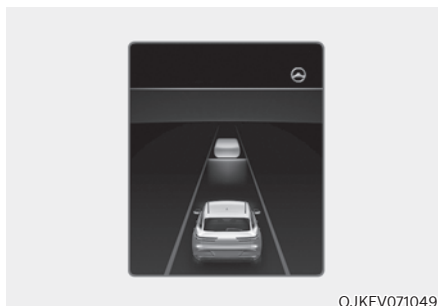

OJKEV071049

If the vehicle ahead and/or both lane markings are detected and your vehicle speed is below 200 km/h (120 mph), the green  indicator light illuminates on the cluster, and Lane Following Assist helps center the vehicle in the lane by assisting the steering wheel.



### CAUTION

**When the steering wheel is not assisted, the white  indicator light blinks and change to grey.**

### Hands-off warning

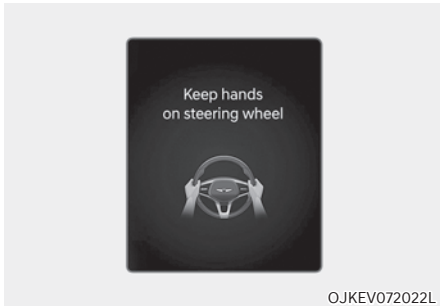

If the driver takes their hands off the steering wheel for several seconds, the 'Keep hands on steering wheel' warning message will appear and an audible warning will sound in stages.

First stage: Warning message

Second stage: Warning message (red steering wheel) and audible warning

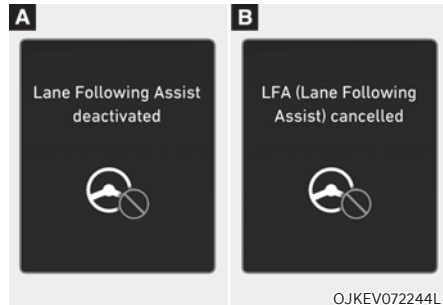

If the driver still does not have their hands on the steering wheel after the hands-off warning, the 'LFA (Lane Following Assist) cancelled' (or 'Lane Following Assist deactivated') warning message will appear and Lane Following Assist will be automatically cancelled.

### WARNING

- **The steering wheel may not be assisted if the steering wheel is held very tight or the steering wheel is steered over a certain degree.**
- **Lane Following Assist does not operate at all times. It is the responsibility of the driver to safely steer the vehicle and to maintain the vehicle in its lane.**
- **The hands-off warning message may appear late depending on road conditions. Always have your hands on the steering wheel while driving.**
- **If the steering wheel is held very lightly the hands-off warning message may appear because Lane Following Assist may not recognize that the driver has their hands on the steering wheel.**
- **If you attach objects to the steering wheel, the hands-off warning may not work properly.**

### **i** Information

- For more details on instrument cluster settings, refer to “LCD display control” section in chapter 4.
- When both lane markings are detected, the lane lines on the cluster will change from grey to white.

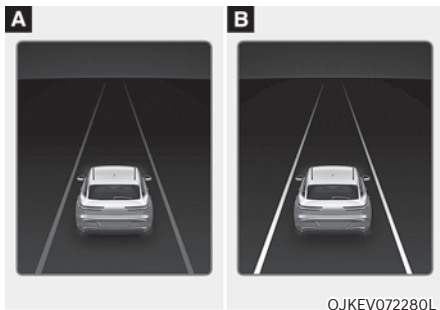



[A]: Lane undetected, [B]: Lane detected

- The images and colors in the instrument cluster may differ depending on the cluster type or theme selected from the settings menu.
- If lane markings are not detected, steering wheel control by Lane Following Assist can be limited depending on whether a vehicle is in front or the driving conditions of the vehicle.
- Even though the steering is assisted by Lane Following Assist, the driver may control the steering wheel.
- The steering wheel may feel heavier or lighter when the steering wheel is assisted by Lane Following Assist than when it is not.

## Lane Following Assist malfunction and limitations

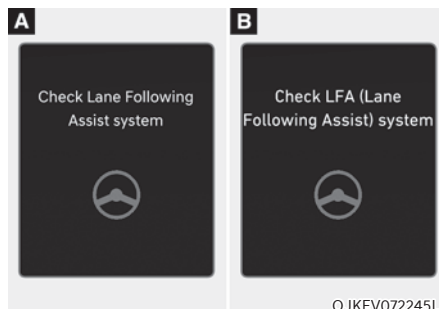
### *Lane Following Assist malfunction*



When Lane Following Assist is not working properly, the ‘Check LFA (Lane Following Assist) system’ (or ‘Check Lane Following Assist system’) warning message will appear for several seconds, and the master () warning light will illuminate on the cluster. If this occurs, we recommend that the vehicle be inspected by an authorized retailer of Genesis Branded products.

### *Limitations of Lane Following Assist*

For more details on Lane Following Assist limitations, refer to “Lane Keeping Assist (LKA)” section in this chapter.

### **i** Information

**For more details on Lane Following Assist precautions, refer to “Lane Keeping Assist (LKA)” section in this chapter.**

## HIGHWAY DRIVING ASSIST (HDA) (IF EQUIPPED)

### Basic function

Highway Driving Assist is designed to do the following while driving on the highway:

- Help detect vehicles ahead
- Help detect lanes ahead
- Help maintain distance from the vehicle ahead
- Help maintain set speed
- Help center the vehicle in the lane

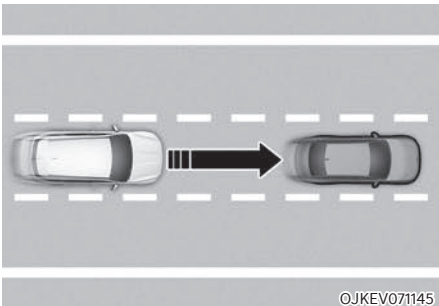

### Highway Lane Change Assist (if equipped)

Highway Lane Change Assist function helps change lanes to the direction the driver slightly moves the turn signal switch if the function judges that lane change is possible.

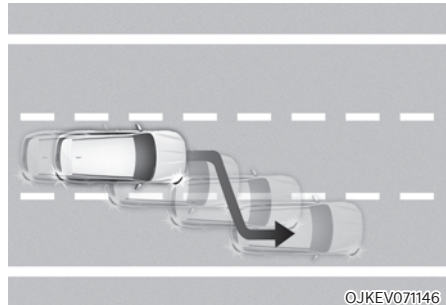

### **i** Information

- **Highway Driving Assist is available only on controlled access road of certain highways.**
  - \* **Controlled access road indicates roads with limited entrances and exits that allow uninterrupted high speed traffic flow. Only passenger cars and motorcycles are allowed on controlled access roads.**
- **Additional highways may be expanded by future navigation updates.**

### **i** Information

**Highway Driving Assist operates on main roads of highways (or motorways), and does not operate on interchanges or junctions.**

## Detecting sensor

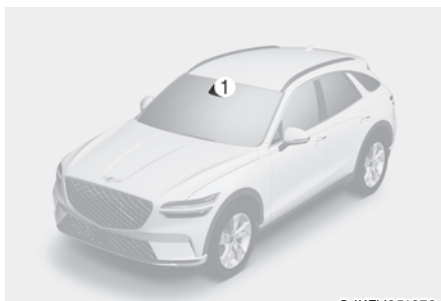

OJKEV051076



OJKEV071089

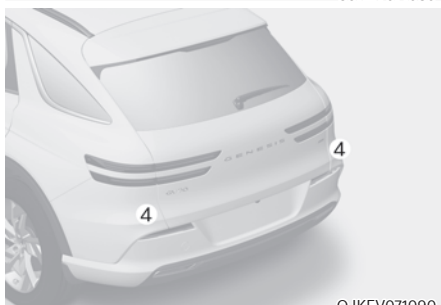

OJKEV071090

- [1]: Front view camera, [2]: Front radar,  
[3]: Front corner radar (if equipped),  
[4]: Rear corner radar (if equipped)

Refer to the picture above for the detailed location of the detecting sensors.

## CAUTION

For more details on the precautions of the detecting sensors, refer to “Forward Collision-Avoidance Assist (FCA)” section in this chapter.

## Highway Driving Assist settings

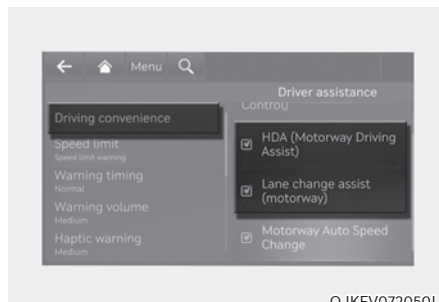

OJKEV072050L

With the vehicle on, select or deselect ‘Driver assistance → Driving convenience’ from the Settings menu to set whether to use each function.

### Basic function

If ‘HDA (Motorway Driving Assist)’ is selected, it helps maintain distance from the vehicle ahead, maintain the set speed, and helps center the vehicle in the lane.

### Highway Lane Change Assist (if equipped)

If ‘Lane change assist (motorway)’ is selected, it helps the driver change lanes.

**i** Information

- When 'HDA (Motorway Driving Assist)' is deselected, the setting for 'Lane change assist (motorway)' cannot be changed.
- If there is a problem with the functions, the settings cannot be changed. We recommend that the vehicle be inspected by an authorized retailer of Genesis Branded products.
- If the vehicle is restarted, the functions will maintain the last setting.

**⚠** WARNING

For your safety, only change the Settings after parking the vehicle at a safe location.

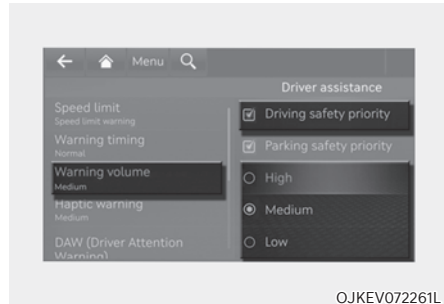

**Warning volume**

With the vehicle on, select 'Driver assistance → Warning volume' or 'Sound → Driver assistance → Warning volume' from the Settings menu to change the Warning Volume to 'High', 'Medium', 'Low' or 'Off' for Highway Driving Assist.

If 'Driving safety priority' is selected, the vehicle lowers all other audio volumes when the warning sounds for safe driving.

**i** Information

- If 'Off' is selected, the Hands-off Warning volume will not turn off, but the volume will sound as 'Low'.
- If you change the Warning volume, the Warning volume of other Driver Assistance systems may change.



## Highway Driving Assist operation

### Basic function

#### Displaying operating status

You can see the status of the Highway Driving Assist operation in the Driving Assist view on the cluster. Refer to “View Modes” section in chapter 4.

Highway Driving Assist will be displayed as below depending on the status of the function.

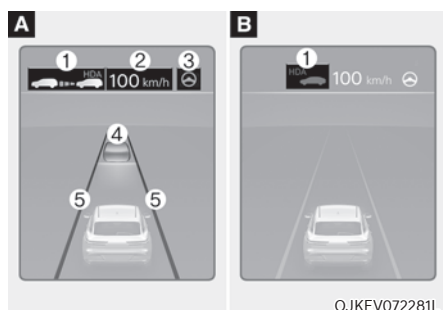

[A]: Operating state, [B]: Standby state

- (1) Highway Driving Assist indicator, whether there is a vehicle ahead and the selected distance level are displayed.
  - \* Highway Driving Assist indicator
    - Green HDA : Operating state
    - Grey HDA : Standby state
    - White HDA blink: Accelerator depressed state
- (2) Set speed
- (3) Lane Following Assist indicator
- (4) Whether there is a vehicle ahead and the selected headway
- (5) Whether the lane is detected or not

### **i** Information

- For more details on the display refer to “Smart Cruise Control (SCC)” and “Lane Following Assist (LFA)” sections in this chapter.
- The images and colors in the instrument cluster may differ depending on the cluster type or theme selected from the settings menu.

### Highway Driving Assist operation

Highway Driving Assist operates when:

- Driving on the main road of highways, and turning on Highway Driving Assist by pressing the Driving Assist button.
- Entering the main road of highways while Lane Following assist and Smart Cruise Control are operating

### Restarting after stopping



When Highway Driving Assist is operating, your vehicle will stop if the vehicle ahead of you stops. Also, if the vehicle ahead of you starts moving within 30 seconds after the stop, your vehicle will start as well. In addition, after the vehicle has stopped and 30 seconds have passed, the 'Use switch or pedal to accelerate' message will appear on the cluster. Depress the accelerator pedal or operate the + switch, - switch or  to start driving.

### Hands-off warning

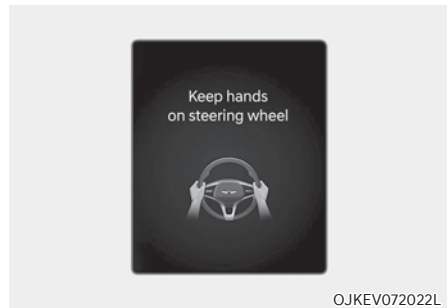

If the driver takes their hands off the steering wheel for several seconds, the 'Keep hands on steering wheel' warning message will appear and an audible warning will sound in stages.  
First stage: Warning message  
Second stage: Warning message (red steering wheel) and audible warning

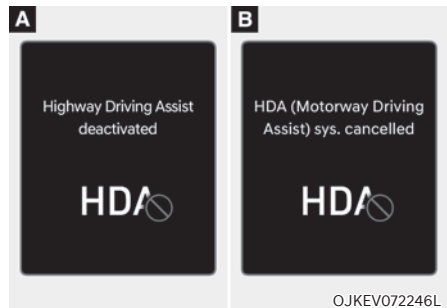

If the driver still does not have their hands on the steering wheel after the hands-off warning, 'HDA (Motorway Driving Assist) sys. cancelled' (or 'Highway Driving Assist deactivated') warning message will appear and Highway Driving Assist and Lane Change Assist will be automatically cancelled.

## Driving speed limit

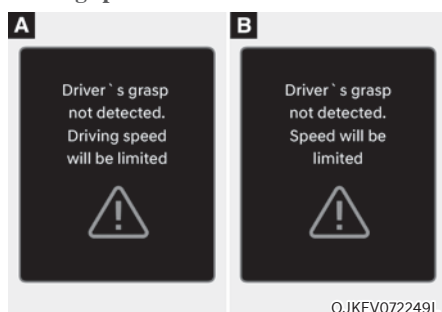

When Highway Driving Assist is cancelled by the hands-off warning, The driving speed will be limited.

While Driving Speed Limit function is operating, the 'Driver's grasp not detected. Speed will be limited' (or 'Driver's grasp not detected. Driving speed will be limited') warning message will appear on the cluster, and an audible warning will sound continuously.

## Driving to one side within lane (if equipped)

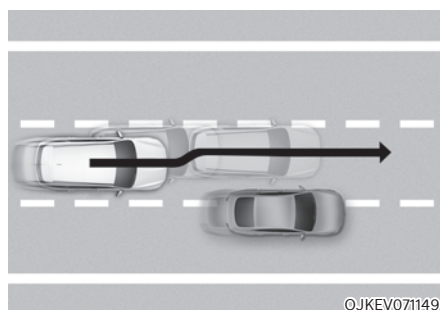

When vehicle speed is above 60 km/h (40 mph), if a vehicle around you is driving at a close distance, your vehicle will control steering in the opposite direction of the vehicle to assist in safe driving.

If there are vehicles in both sides of the lane that are driving close to you, the function will not veer to the opposite side of the lane.

## Highway Driving Assist standby

When the Smart Cruise Control is temporarily cancelled while Highway Driving Assist is operating, Highway Driving Assist will be in the standby state. At this time, Lane Following Assist will operate properly.

**i Information**

- **Driving Speed Limit helps you drive below 60 km/h (40 mph). At this time, the vehicle decelerates due to the vehicle ahead. After the vehicle has decelerated, it cannot automatically accelerate.**
- **Driving Speed Limit will cancel in the following circumstances:**
  - **When the driver grabs the steering wheel again**
  - **When the driver turns on Lane Following Assist by pressing the Lane Driving Assist button**
  - **When +, -, || ↻ switch or  button is operated, or the accelerator pedal or the brake pedal is depressed**

**Highway Lane Change Assist (if equipped)**



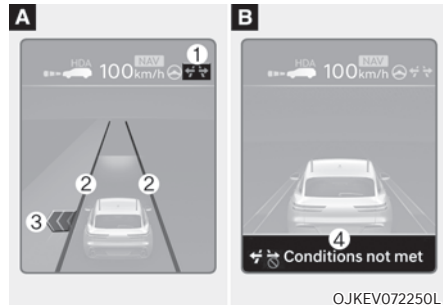

**Displaying operating status**

You can see the status of the Highway Lane Change Assist function operation in the Driving Assist view on the cluster. Refer to “View Modes” section in chapter 4.

Highway Lane Change Assist function will be displayed as below depending on the status of the function.



[A]: Ready/Operating, [B]: Standby/Cancelled

- (1) Highway Lane Change Assist indicator
  - Green  on : Ready state
  - Green  blink : Operating state
  - Grey  on : Standby state
  - White  blink : Canceled state (display  only a certain time)
- (2) Lane line
 

The lane line is displayed same as the Highway Lane Change Assist indicator (1). However, if the function is on standby, it displays whether the lane line is detected.
- (3) Green arrow and shade
 

The green arrow is displayed when a certain amount of time has passed after the function has started operating, and until the lane change has completed.
- (4) Message
  - Message is displayed when the function does not operate even though the turn signal is used.
  - Message is displayed when the function is cancelled while operating.

OJKEV072250L

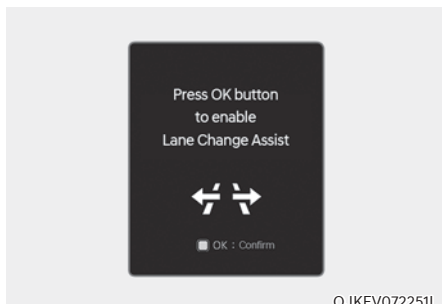

OJKEV072251L

### To turn on Highway Lane Change Assist

Highway Lane Change Assist function will turn on when the following conditions are satisfied.

- The Driving Assist button or Lane Driving Assist button is used to turn on Highway Driving Assist.
- The OK button is pressed on the steering wheel while a message asking to use Highway Lane Change Assist is displayed on the cluster.

### Highway Lane Change Assist ready to operate

While Highway Lane Change Assist function is on, the function will be ready to operate when all the following conditions are satisfied:

- Highway Driving Assist is operating
- Lane Following Assist is operating
- A vehicle in the rear area of your vehicle is detected more than once after the vehicle is turned on
- Your vehicle speed is above 80 km/h (50 mph)
- Hands-off warning is not displayed on the cluster
- Hazard warning flasher is off

### **i** Information

- While Lane Change Assist function is turned on (indicator on), Lane Following Assist will not cancel even if the turn signal indicator or hazard warning flasher is operating.
- Lane Change Assist function turns off automatically when driven in the following road conditions:
  - One driving lane
  - A road with an intersection or crosswalk ahead
  - A road with no structure, such as a medium strip, guardrails, etc.
  - There is a pedestrian or cyclist on the road ahead
- When the function is in the ready state, and vehicle speed is below 55 km/h (34 mph), the function will change to the standby state.



### **WARNING**

When Highway Lane Change Assist function turns off while operating, steering assist will be temporarily cancelled. Always be cautious while driving.

### Highway Lane Change Assist operating

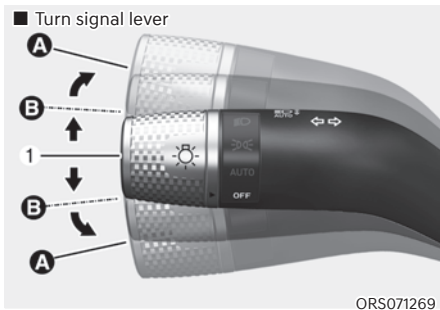

[1]: Center

Highway Lane Change Assist function will operate, when you push the turn signal lever up or down to the A or B position while the function is in the ready state (☀ indicator is green), and all of the following conditions are satisfied:

- The driver has his/her hand on the steering wheel
- There is no collision risk in the direction of lane change
- There is a single dotted lane line in the direction of lane change
- There are no Forward Collision-Avoidance Assist and Blind Spot Collision-Avoidance Assist warnings
- The vehicle is driven in the middle of the lane (should not be driving close to one side of the lane)
- The road you are driving on, or the road you are about to change lane is a road that the function can operate

### **i** Information

- Highway Lane Change Assist operates when the turn signal lever is positioned at A. If the turn signal lever is released to the center (1) before stepping on the lane, Highway Lane Change Assist cancels. If the turn signal lever is released to the center (1) after stepping on the lane, Highway Lane Change Assist changes the lane and turns off the turn signal after lane change is complete.
- When the turn signal lever is placed at B position for a certain period of time, the green arrow will appear. At this time, even when the lever is released and returns to its original position (1), lane change will still be assisted.
- While lane change is being made by the function, the turn signal indicator will blink even when the turn signal lever is not held, and the turn signal indicator will turn off when lane change is complete.

- **Highway lane change assist does not operate on the entrance or exit of the highway.**

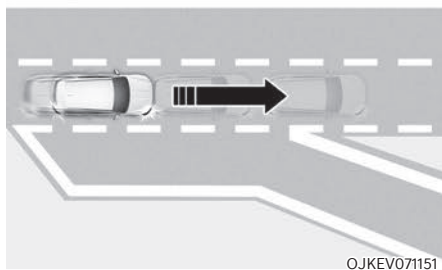
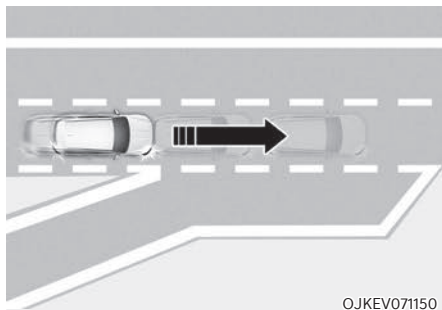

#### Highway Lane Change Assist standby

Highway Lane Change Assist function will be in the standby state when one of the ready state condition is not satisfied, or when entering or driving on one of the following roads:

- Road within a certain distance from the tollgate on the main road of the highway (or motorway)
- The road ahead ends without an interchange or junction
- Road with sharp curves
- Road with narrow lanes
- Road that is under construction

#### Highway Lane Change Assist cancel

The function will be cancelled when:

- The turn signal lever is moved to the A position while the Highway Lane Change Assist function is operating and placed in the center (1) before stepping on the lane line.
- The turn signal lever is turned on in the opposite direction of lane change
- The steering wheel is steered sharply



## **WARNING**

- While the function is operating, the function will cancel if one of the following occurs:
  - Highway Driving Assist is turned off
  - Lane Following Assist or Smart Cruise Control is turned off or temporarily cancelled
  - Hands-off warning message is displayed on the cluster
  - The hazard warning flasher is turned on
  - Forward Collision-Avoidance Assist or Blind-Spot Collision-Avoidance Assist warning message is displayed
  - Possible collision is detected in the next lane, even though there are no Forward Collision-Avoidance Assist and Blind Spot Collision-Avoidance Assist warning
  - Entering a road under construction
  - The target lane to make a lane change disappears
  - The target lane to make a lane change is not detected
  - There is a problem with turn signal lamps
- Highway Lane Change Assist function is off (The function turns off when the function is turned off from the settings menu, when the road changes to a one-way road, when there is a intersection or crosswalk ahead, when you enter a road with no structure, such as a medium strip, guardrail, etc., or when there is a pedestrian or cyclist on the driving lane.)
- Your vehicle speed is below 75 km/h (45 mph)
- While the function is operating, when the function is cancelled, depending on the driving conditions, the vehicle may drive to the middle of the driving lane or steering assist may stop. Always pay attention to road and driving conditions while driving.
- The function may not operate properly on roads with pedestrians or cyclists, such as an intersection or crosswalk. Always pay attention to road and driving conditions while driving.



## Highway Driving Assist malfunction and limitations

### Highway Driving Assist malfunction

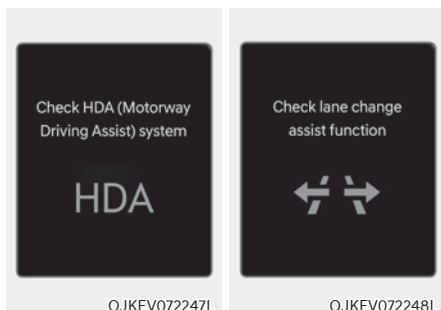

When Highway Driving Assist or Highway Lane Change function is not working properly, the 'Check HDA (Motorway Driving Assist) system' warning message will appear, and the  warning light will illuminate on the cluster. We recommend that the vehicle be inspected by an authorized retailer of Genesis Branded products



### WARNING

- The driver is responsible for controlling the vehicle for safe driving.
- Always have your hands on the steering wheel while driving.
- Highway Driving Assist is a supplemental function that assists the driver in driving the vehicle and is not a complete autonomous driving system. Always check road conditions, and if necessary, take appropriate actions to drive safely.
- Always have your eyes on the road, and it is the responsibility of the driver to avoid violating traffic laws. The vehicle manufacturer is not responsible for any traffic violation or accidents caused by the driver.
- Highway Driving Assist may not be able to recognize all traffic situations. Highway Driving Assist may not detect possible collisions due to limitations of the function. Always be aware of the limitations of the function. Obstacles such as vehicles, motorcycles, bicycles, pedestrians, or unspecified objects or structures such as guardrails, tollgate, etc., that may collide with the vehicle may not be detected.
- Highway Driving Assist will turn off automatically under the following situations:
  - Driving on roads that Highway Driving Assist does not operate, such as a rest area, intersection, junction, etc.
  - The navigation does not operate properly such as when the navigation is being updated or restarted
- Highway Driving Assist may inadvertently operate or turn off depending on road conditions (navigation information) and surroundings.
- Lane Following Assist function may be temporarily disabled when the front view camera cannot detect lanes properly or the hands-off warning is on.
- You may not hear the warning sound of Highway Driving Assist if the surrounding is noisy.

- **If the vehicle is driven at high speed above a certain speed at a curve, your vehicle may drive to one side or may depart from the driving lane.**
  - **When you are towing a trailer or another vehicle, turn off Highway Driving Assist for safety reasons.**
  - **The hands-off warning message may appear early or late depending on how the steering wheel is held or road conditions. Always have your hands on the steering wheel while driving.**
  - **For your safety, please read the owner's manual before using the Highway Driving Assist.**
  - **Highway Driving Assist will not operate when the vehicle is started, or when the detecting sensors or navigation is being initialized.**
- GPS signals are blocked in areas such as a tunnel
  - The driver goes off course or the route to the destination is changed or cancelled by resetting the navigation
  - The vehicle enters a service station or rest area
  - Android Auto or Car Play is operating
  - The navigation cannot detect the current vehicle position (for example, elevated roads including overpass adjacent to general roads or nearby roads exist in a parallel way)
  - White single dotted lane line or road edge cannot be detected
  - The road is temporarily controlled due to construction, etc.
  - There is no structure, such as a medium strip, guardrails, etc., on the road
  - There is a changeable lane in the direction of lane change

### **Limitations of Highway Driving Assist**

Highway Driving Assist and Highway Lane Change function may not operate properly, or it may not operate under the following circumstances:

- The map information and the actual road is different because the navigation is not updated
- The map information and the actual road is different because of real-time GPS data or map information error
- The infotainment system is overloaded by simultaneously performing functions such as route search, video playback, voice recognition, etc.

### **Information**

**For more details on the limitations of the front view camera, front radar, front corner radar and rear corner radar, refer to “Forward Collision-Avoidance Assist (FCA)” section in this chapter.**

## REAR VIEW MONITOR (RVM) (IF EQUIPPED)

Rear View Monitor shows the area behind the vehicle to assist you when parking or backing up.

### Detecting sensor



[1]: Wide-rear view camera

Refer to the picture above for the detailed location of the detecting sensor.

## Rear View Monitor settings

### Warning volume

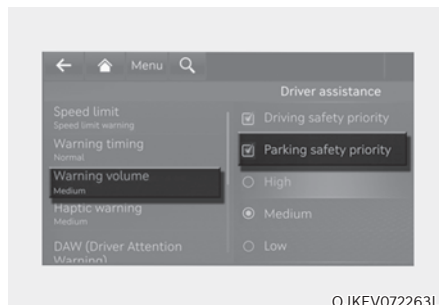

With the vehicle on, select 'Driver assistance → Warning volume → Parking safety priority' or 'Sound → Driver assistance → parking safety priority' from the Setting menu.

If 'Parking safety priority' is selected, the vehicle lowers all other audio volumes when the Rear View Monitor is operating for safe parking.

## Camera settings

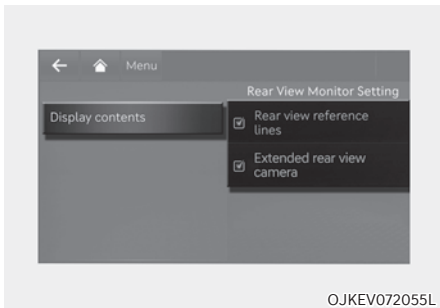

You can change Rear View Monitor 'Display contents' by touching the setup icon (⚙️) on the screen while Rear View Monitor is operating, or selecting 'Driver assistance → parking safety → Camera Settings' from the Settings menu while the vehicle is on.

- If 'Display contents' is selected, you may set whether to use 'Rear view reference lines (Rear View Parking Guide Lines)' or 'Extended rear view camera'.

## Rear View Parking Guide Lines

If 'Rear view reference lines (Rear View Parking Guide Lines)' is selected, the rear view parking guide lines and rear top view guide lines will be displayed at the left side of the infotainment system screen.

### Information

- **The horizontal guideline of the Rear View Parking Guidance shows the distance of 0.5 m (1.6 ft.), 1 m (3.3 ft.) and 2.3 m (7.6 ft.) from the vehicle.**
- **The horizontal guideline of the Rear Top View Parking Guidance shows the tailgate opening distance and the distance of 1.5 m (4.9 ft.) from the vehicle.**

## Extended Rear View Monitor

With the vehicle on, select 'Driver assistance → parking safety → Camera Settings' from the infotainment system Settings menu to turn on Extended Rear View function and deselect to turn off the function.

## Rear View Monitor operation

### Parking/View button

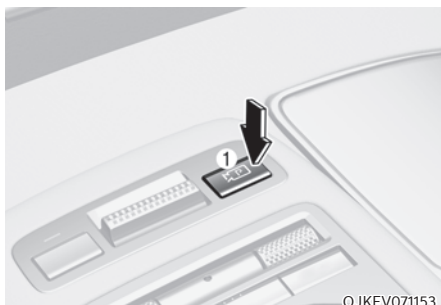

Press the Parking/View button (1) to turn on Rear View Monitor.

Press the button again to turn off the function.

## Rear View function



### Operating conditions

- Shift the gear to R (Reverse), the image will appear on the screen.
- Press the Parking/View button (1) while the gear is in P (Park), the image will appear on the screen.

### Operating conditions

- The rear view cannot be turned off when the gear is in R (Reverse).
- Press the Parking/View button (1) again while the gear is in P (Park) with the rear view on the screen, the rear view will turn off.
- Shift the gear from R (Reverse) to P (Park), the rear view will turn off.

### **Extended Rear View function**

Extended Rear View function maintains showing the rear view when the gear is R (Reverse), N (Neutral) or D (Drive).

Extended Rear View will turn on under the following conditions:

- The gear is in P (Park), N (Neutral) or D (Drive), and vehicle speed is 10 km/h (6 mph) or less.

Extended Rear View will turn off under the following conditions:

- The gear is shifted to P (Park).
- The Parking/View button (1) is pressed.
- Vehicle speed is above 10 km/h (6 mph).

### **Rear View while driving**



The driver is able to check the rear view on the screen while driving, it is to assist with backing up.

### **Operating conditions**

Press the Parking/View button (1) while the gear is in D (Drive) or N (Neutral), the driving rear view will appear on the screen.

### **Off conditions**

- Press the Parking/View button (1) again, the driving rear view will turn off.
- Press one of the infotainment system button (2), the driving rear view will turn off.
- Shift the gear to P (Park), the driving rear view will turn off.

### **When operating**

If the gear is shifted to R (Reverse), while Driving rear view is displayed on the screen, the screen will change to rear view.

### Rear Top View



When you touch the  icon, the top view is displayed on the screen and shows the distance from the vehicle in the back of your vehicle while parking.

## Rear View Monitor malfunction and limitations

### Rear View Monitor malfunction

When Rear View Monitor is not working properly, or the screen flickers, or the camera image does not display properly, we recommend that the vehicle be inspected by an authorized retailer of Genesis Branded products.



### WARNING

- **The rear view camera does not cover the complete area behind the vehicle. The driver should always check the rear area directly through the inside and outside rearview mirror before parking or backing up.**
- **The image shown on the screen may differ from the actual distance of the object. Make sure to directly check the vehicle's surroundings for safety.**
- **Always keep the rear view camera lens clean. If the lens is covered with foreign material, it may adversely affect camera performance and Rear View Monitor may not operate properly. However, do not use chemical solvents such as strong detergents containing high alkaline or volatile organic solvents (gasoline, acetone etc.). This may damage the camera lens.**

## SURROUND VIEW MONITOR (SVM) (IF EQUIPPED)

Surround View Monitor can assist in parking by allowing the driver to see around the vehicle.

### Detecting sensor

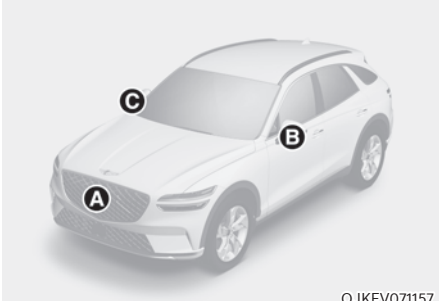

OJKEV071157

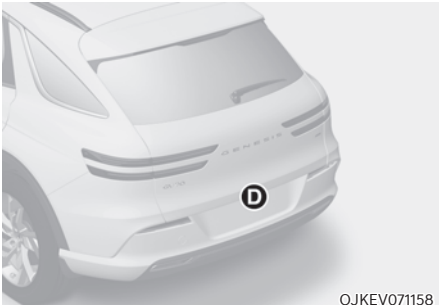

OJKEV071158

- [A]: Wide-front view camera,
- [B],[C]: Wide-side view camera  
(Below the outside rearview mirror),
- [D]: Wide-rear view camera

Refer to the picture above for the detailed location of the detecting sensors.

### Surround view Monitor settings Warning volume

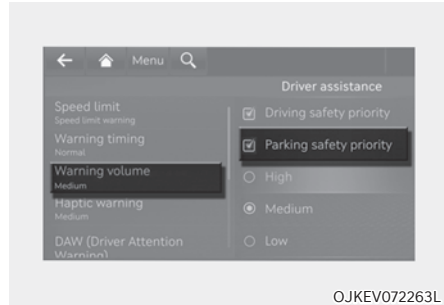

OJKEV072263L

With the vehicle on, select 'Driver assistance → Warning volume → Parking safety priority' or 'Sound → Driver assistance → Parking safety priority' from the Setting menu.

If 'Parking safety priority' is selected, the vehicle lowers all other audio volumes when Rear View Monitor is operating for safe parking.



## Camera settings

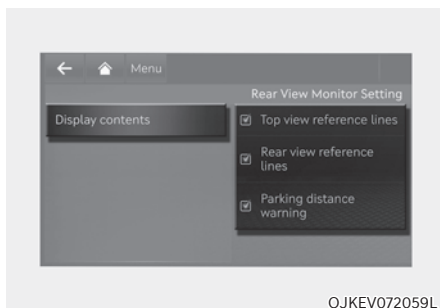

You can change Surround View Monitor 'Display Contents' or 'Display Settings' by touching the setup icon (⚙️) on the screen while Surround View Monitor is operating, or selecting 'Driver assistance → parking safety → Camera Settings' from the Settings menu while the vehicle is on.

- If 'Display Contents' is selected, you may set whether to use 'Top view reference lines (Top View Parking Guide Lines), Rear view reference lines (Rear View Parking Guide Lines), Parking Distance warning'.

### Top View Parking Guide Lines

When the 'Top view reference lines (Top View Parking Guide Lines)' is selected, parking guidance is displayed on the right side of the Surround View Monitor screen.

#### **i** Information

The horizontal guideline of the Rear Top View Parking Guidance shows the tailgate opening distance and the distance of 2 m (6.6 ft.) from the vehicle.

### Rear View Parking Guide Lines

When the 'Rear view reference lines (Rear View Parking Guide Lines)' is selected, parking guidance is displayed in the rear view.

#### **i** Information

The horizontal guideline shows the distance of 0.5 m (1.6 ft.), 1 m (3.3 ft.) and 2.3 m (7.6 ft.) from the vehicle.

### Parking Distance Warning

When the 'Parking Distance Warning' is selected, parking distance warning is displayed on the right side of the Surround View Monitor screen.

- The image will be displayed only when Parking Distance Warning is warning the driver.

### Surround view monitor auto On

With the vehicle on, select 'Driver assistance → Parking safety → Surround view monitor auto On' from the Settings menu to use the function.

#### **i** Information

For more details on Surround view monitor auto On, refer to "Surround View Monitor operation" in this section.

## Surround View Monitor operation

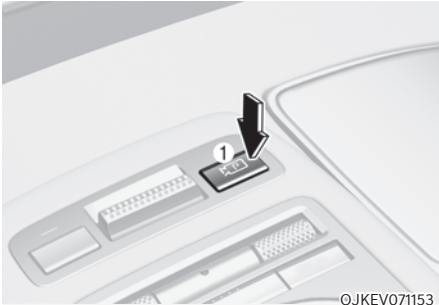

Press the Parking/View button (1) to turn on Surround View Monitor.  
Press the button again to turn off the function.

### Front view

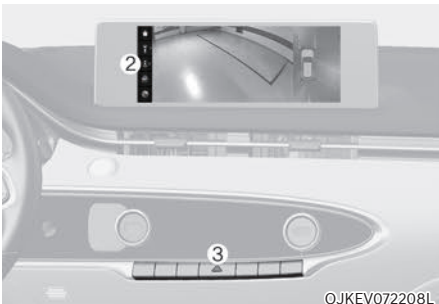

The front image is displayed on the screen when the gear is in N (Neutral) or D (Drive) to assist in parking. Using the view button (2) you may select top view, front view, side view and 3D view.

The front view function will turn on under the following conditions:

- The gear is in N (Neutral) or D (Drive), and vehicle speed is 15 km/h (9 mph) or less.
- The Parking/View button (1) is pressed, while the gear is in N (Neutral) or D (Drive), and vehicle speed is 15 km/h (9 mph) or less.
- Surround view monitor auto On function will operate when the following conditions are satisfied:
  - With 'Driver assistance → Parking safety → Surround view monitor auto On' selected from the Settings menu, the front view screen is displayed when Parking Distance Warning warns the driver while driving in D (Drive).

### **i** Information

**When the front view is turned on, the previous view mode will be displayed.**

The front view function will turn off under the following conditions:

- The Parking/View button (1) or the infotainment system button (3) is pressed.
- Vehicle speed is above 15 km/h (9 mph).
- The gear is shifted to P (Park).

### **i** Information

**Surround View Monitor will turn off when vehicle speed is above 15 km/h (9 mph). However, Surround View Monitor will not turn on again although vehicle speed drops below 10 km/h (6 mph).**

## Rear view



The rear image is displayed on the screen when the gear is in P (Park) to assist in parking. Using the view button (2) you may select top view, rear view, side view and 3D view.

The rear view function will turn on under the following conditions:

- The gear is shifted to R (Reverse).
- The Parking/View button (1) button is pressed when gear is in P (Park).

The rear view function will turn off under the following conditions:

- The gear is shifted from R (Reverse) to P (Park).
- The Parking/View button (1) button is pressed when gear is in P (Park).

### **i** Information

**When the gear is in R (Reverse), the rear view does not turn off even if the infotainment system button (3) is pressed.**

## Rear View while driving

The driver can check the rear view on the screen while driving. The rear view while driving consist of a rear view while driving and a rear wide view while driving. Also, you can change the view mode you want to select by pressing the view button (2) on the infotainment system screen.

Rear View while driving function will turn on under the following conditions:

- The Parking/View button (1) is pressed, while driving above 15 km/h (9 mph).
- **i** is selected among the view buttons (2) when vehicle speed is 15 km/h (9 mph) or less.

Rear View while driving function will turn off under the following conditions:

- The Parking/View button (1) or the infotainment system button (3) is pressed.
- The gear is shifted to P (Park).
- Other view modes are selected when vehicle speed is 15 km/h (9 mph) or less.

### **i** Information

**When the rear view while driving is turned on again, the previous view mode will be displayed.**

## Surround View Monitor malfunction and limitations

### *Surround View Monitor malfunction*

When Surround View Monitor is not working properly, or the screen flickers, or the camera image does not display properly, we recommend that the vehicle be inspected by an authorized retailer of Genesis Branded products.

### *Limitations of Surround View Monitor*

The screen may be displayed abnormally, and an icon will appear at the top left side of the screen under the following circumstances:

- The tailgate is opened
- The driver or front passenger door is opened
- The outside rearview mirror is folded



## WARNING

- **ALWAYS** look around your vehicle to make sure there are no objects or obstacles before moving the vehicle. What you see on the screen may differ from the actual vehicle's location.
- The image shown on the screen may differ from the actual distance of the object. Make sure to directly check the vehicle's surroundings for safety.
- Surround View Monitor is designed to be used on a flat surface. Therefore, if used on roads with different heights such as curbs and speed bumps, the image in the screen may not look correct.
- Always keep the camera lens clean. If the lens is covered with foreign material, it may adversely affect camera performance and Surround View Monitor may not operate properly. However, do not use chemical solvents such as strong detergents containing high alkaline or volatile organic solvents (gasoline, acetone etc.). This may damage the camera lens.



## Information

- When Rear View while driving is on, it stays on while driving regardless of vehicle speed.
- When Rear View while driving is on while backing up, the screen changes to the rear view.

## REAR CROSS-TRAFFIC COLLISION-AVOIDANCE ASSIST (RCCA) (IF EQUIPPED)

Rear Cross-Traffic Collision-Avoidance Assist is designed to help detect vehicles approaching from the left and right side while your vehicle is reversing. When a vehicle is detected, the system will warn the driver that a collision is imminent with a visual and audible warning. The system can also provide braking assist to help prevent a collision.



[A]: Rear Cross-Traffic Collision Warning operating range,

[B]: Rear Cross-Traffic Collision-Avoidance Assist operating range



### CAUTION

Warning timing may vary depending on the speed of the approaching vehicle.

### Detecting sensor

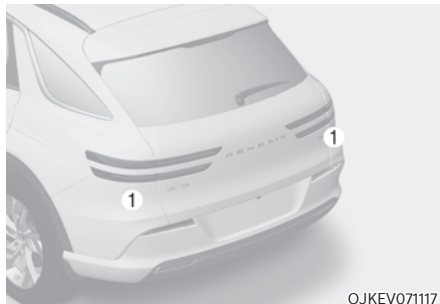

[1]: Rear corner radar

Refer to the picture above for the detailed location of the detecting sensors.



### Information

For more details on the precautions of the rear corner radar, refer to “Blind-Spot Collision-Avoidance Assist (BCA)” section in this chapter.

## Rear Cross-Traffic Collision-Avoidance Assist settings

### Rear cross-traffic safety

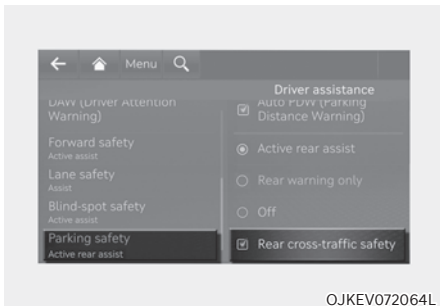

With the vehicle on, select 'Driver assistance → parking safety → Rear cross-traffic safety' from the Settings menu to turn on Rear Cross-Traffic Collision-Avoidance Assist and deselect to turn off the function.

### **WARNING**

When the vehicle is restarted, Rear Cross-Traffic Collision-Avoidance Assist will always turn on. However, if 'Off' is selected after the vehicle is restarted, the driver should always be aware of the surroundings and drive safely.

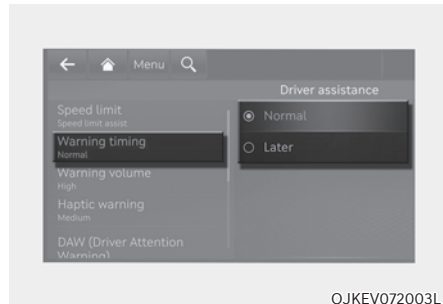

### Warning timing

With the vehicle on, select 'Driver assistance → Warning timing' from the Settings menu to change the initial warning activation time for Rear Cross-Traffic Collision-Avoidance Assist. The warning time can be set to either 'Standard (Normal)' or 'Later'.

- Use 'Standard' in normal driving conditions. If the Warning timing seems sensitive, change it to 'Later'.
- If 'Later' is selected, Rear Cross-Traffic Collision-Avoidance Assist, warns the driver more slowly.

### **Information**

If you change the Warning timing, the Warning timing of other Driver Assistance systems may change.

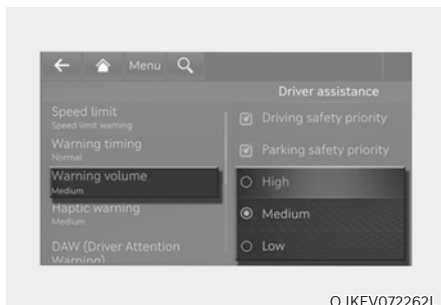

### Warning volume

With the vehicle on, select 'Driver assistance → Warning volume' or 'Sound → Driver assistance → Warning volume' from the Settings menu to change the Warning volume to 'High', 'Medium', 'Low' or 'Off' for Rear Cross-Traffic Collision-Avoidance Assist.

### **i** Information

- **If you change the Warning volume, the Warning volume of other Driver Assistance systems may change.**
- **If 'Off' is selected, steering wheel vibration will not turn off.**

### **!** CAUTION

- **The setting of the Warning timing and Warning volume applies to all functions of Rear Cross-Traffic Collision-Avoidance Assist.**
- **Even though 'Normal (Standard)' is selected for Warning timing, if the vehicles from the left and right side approaches at high speed, the warning may seem late.**
- **Select 'Later' for Warning timing when traffic is light and when driving speed is slow.**

### **i** Information

**If the vehicle is restarted, Warning timing and Warning volume will maintain the last setting.**

### Rear Cross-Traffic Collision-Avoidance Assist operation

Rear Cross-Traffic Collision-Avoidance Assist will warn and control the vehicle depending on collision risk level: 'Collision Warning', 'Emergency Braking' and 'Stopping vehicle and ending brake control'.



OJKEV051027

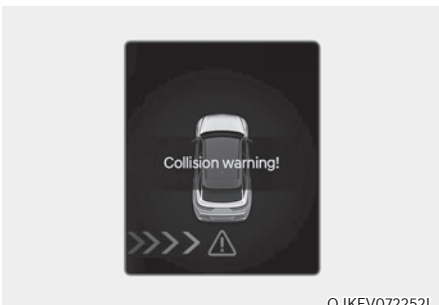

OJKEV072252L

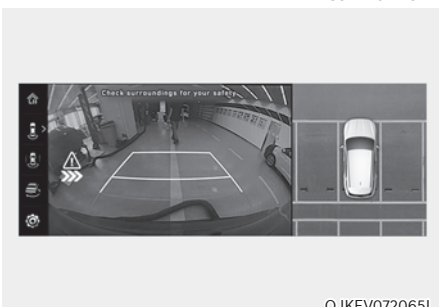

OJKEV072065L

### Collision warning

- To warn the driver of an approaching vehicle from the rear left/right side of your vehicle, the warning light on the outside rearview mirror will blink and a warning will appear on the cluster. At the same time, an audible warning will sound and the steering wheel will vibrate. If the Rear View Monitor is operating, a warning will also appear on the infotainment system screen.
- Rear Cross-Traffic Collision-Avoidance Assist will operate when all the following conditions are satisfied:
  - The gear is shifted to R (Reverse)
  - Vehicle speed is below 8 km/h (5 mph)
  - The approaching vehicle is within approximately 25 m (82 ft.) from the left and right side of your vehicle
  - The speed of the vehicle approaching from the left and right is above 5 km/h (3 mph)

### **i** Information

- **If the operating conditions are satisfied, there will be a warning whenever the vehicle approaches from the left or right side even though your vehicle speed is 0 km/h (0 mph).**
- **The images and colors in the cluster may differ depending on the cluster type or theme selected from the cluster.**



## Emergency braking



©JKEV051027

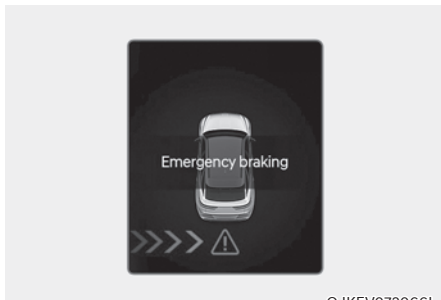

OJKEV072066L

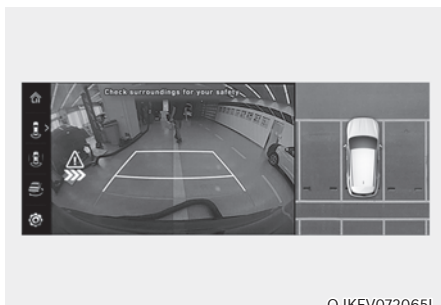

OJKEV072065L

- To warn the driver of an approaching vehicle from the rear left/right side of your vehicle, the warning light on the outside rearview mirror will blink and a warning message will appear on the cluster. At the same time, an audible warning will sound and the steering wheel will vibrate. A warning will also appear on the infotainment system screen.

- Rear Cross-Traffic Collision-Avoidance Assist will operate when all the following conditions are satisfied:
  - The gear is shifted to R (Reverse)
  - Vehicle speed is below 8 km/h (5 mph)
  - The approaching vehicle is within approximately 1.5 m (5 ft.) from the left and right side of your vehicle
  - The speed of the vehicle approaching from the left and right is above 5 km/h (3 mph)
- Emergency braking will be assisted to help prevent collision with approaching vehicles from the left and right.

### **WARNING**

**Brake control ends when the conditions of the approaching vehicle from the rear left or right side are as below:**

- The approaching vehicle is out of the detecting range
- The approaching vehicle passes behind your vehicle
- The approaching vehicle does not drive toward your vehicle
- The approaching vehicle speed slows down
- The driver depresses the brake pedal with sufficient power

### Stopping vehicle and ending brake control



- When the vehicle is stopped due to emergency braking, the 'Drive carefully' warning message will appear on the cluster.
- For your safety, the driver should depress the brake pedal immediately and check the surroundings.
- Brake control will end after the vehicle is stopped by emergency braking for approximately 2 seconds.
- During emergency braking, braking control by Rear Cross-Traffic Collision-Avoidance Assist will automatically cancel when the driver excessively depresses the brake pedal.

### **WARNING**

Take the following precautions when using Rear Cross-Traffic Collision-Avoidance Assist:

- For your safety, only change the Settings after parking the vehicle at a safe location.
- If any other system's warning message is displayed or audible warning is generated, Rear Cross-Traffic Collision-Avoidance Assist's warning message may not be displayed and audible warning may not be generated.
- You may not hear the warning sound of Rear Cross-Traffic Collision-Avoidance Assist if the surrounding is noisy.
- Rear Cross-Traffic Collision-Avoidance Assist may not operate if the driver applies the brake pedal to avoid collision.
- During Rear Cross-Traffic Collision-Avoidance Assist operation, the vehicle may stop suddenly injuring passengers and shifting loose objects. Always have the seat belt on and keep loose objects secured.
- Even if there is a problem with Rear Cross-Traffic Collision-Avoidance Assist, the vehicle's basic braking performance will operate properly.
- When Rear Cross-Traffic Collision-Avoidance Assist is operating, braking control by function will automatically cancel when the driver excessively depresses the accelerator pedal.
- Rear Cross-Traffic Collision-Avoidance Assist does not operate in all situations or cannot avoid all collisions.

- Rear Cross-Traffic Collision-Avoidance Assist may warn the driver late or may not warn the driver depending on the road and driving conditions.
- The driver has the responsibility to control the vehicle. Do not solely depend on Rear Cross-Traffic Collision-Avoidance Assist. Rather, maintain a safe braking distance, and if necessary, depress the brake pedal to reduce driving speed or to stop the vehicle.
- Never deliberately operate Rear Cross-Traffic Collision-Avoidance Assist on people, animal, objects, etc. It may cause serious injury or death.



### CAUTION

The brake control may not operate properly depending on the status of ESC (Electronic Stability Control).

There will only be a warning when:

- The ESC (Electronic Stability Control) warning light is on
- ESC (Electronic Stability Control) is engaged in a different function



### Information

If braking is assisted by Rear Cross-Traffic Collision-Avoidance Assist, the driver must immediately depress the brake pedal and check vehicle surroundings.

- Brake control will end when the driver depresses the brake pedal with sufficient power.
- After shifting the gear to R (Reverse), braking control will operate once for left and right vehicle approach.

## Rear Cross-Traffic Collision-Avoidance Assist malfunction and limitations

### Rear Cross-Traffic Collision-Avoidance Assist malfunction

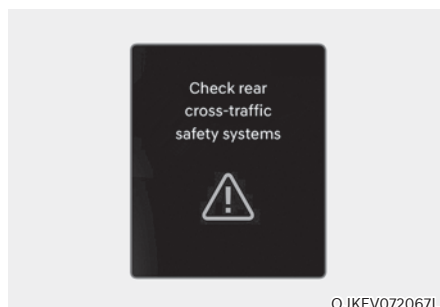

OJKEV072067L

When Rear Cross-Traffic Collision-Avoidance Assist is not working properly, the 'Check rear cross-traffic safety systems' warning message will appear on the cluster for several seconds, and the master (⚠) warning light will illuminate on the cluster. If this occurs, we recommend that the vehicle be inspected by an authorized retailer of Genesis Branded products.

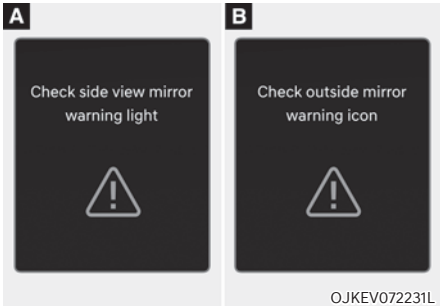

When the outside rearview mirror warning light is not working properly, the ‘Check outside mirror warning icon’ (or ‘Check side view mirror warning light’) warning message will appear on the cluster for several seconds, and the master (⚠) warning light will illuminate on the cluster. If this occurs, we recommend that the vehicle be inspected by an authorized retailer of Genesis Branded products.

### ***Rear Cross-Traffic Collision-Avoidance Assist disabled***



When the rear bumper around the rear-side radar or sensor is covered with foreign material, such as snow or rain, or installing a trailer or carrier, it can reduce the detecting performance and temporarily limit or disable Rear Cross-Traffic Collision-Avoidance Assist.

If this occurs, the ‘Rear cross-traffic safety functions disabled. Radar blocked’ warning message will appear on the cluster.

Rear Cross-Traffic Collision-Avoidance Assist will operate properly when such foreign material or trailer, etc., is removed.

If Rear Cross-Traffic Collision-Avoidance Assist does not operate properly after it is removed, we recommend that the vehicle be inspected by an authorized retailer of Genesis Branded products.



## WARNING

- Even though the warning message does not appear on the cluster, Rear Cross-Traffic Collision-Avoidance Assist may not operate properly.
- Rear Cross-Traffic Collision-Avoidance Assist may not operate properly in an area (for example, open terrain), where any substance are not detected after turning ON the vehicle.



## CAUTION

Turn off Rear Cross-Traffic Collision-Avoidance Assist to install or remove a trailer, carrier, or another attachment. Turn on Rear Cross-Traffic Collision-Avoidance Assist when finished.

### *Limitations of Rear Cross-Traffic Collision-Avoidance Assist*

Rear Cross-Traffic Collision-Avoidance Assist may not operate properly, or it may operate unexpectedly under the following circumstances:

- Departing from where trees or grass are overgrown
- Departing from where roads are wet
- Speed of the approaching vehicle is fast or slow

Braking control may not work, driver's attention is required in the following circumstances:

- The vehicle severely vibrates while driving over a bumpy road, uneven road or concrete patch
- Driving on a slippery surface due to snow, water puddle, ice, etc.
- The tire pressure is low or a tire is damaged
- The brake is modified
- Remote Smart Parking Assist is operating (if equipped)



## Information

For more details on the limitations of the rear corner radar, refer to “Blind-Spot Collision-Avoidance Assist (BCA)” section in this chapter.

 **WARNING**

- Driving near a vehicle or structure

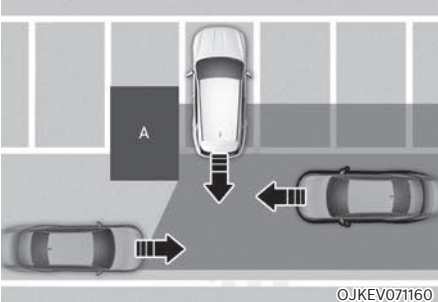

[A]: Structure

Rear Cross-Traffic Collision-Avoidance Assist may be limited when driving near a vehicle or structure, and may not detect the vehicle approaching from the left or right. If this occurs, the function may not warn the driver or control the brakes when necessary.

Always check your surroundings while backing up.

- When the vehicle is in a complex parking environment

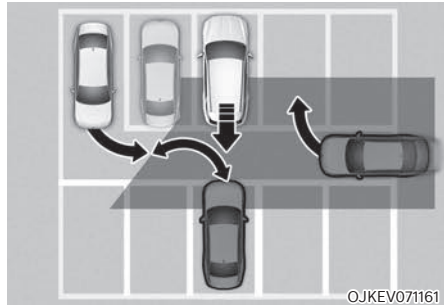

OJKEV071161

Rear Cross-Traffic Collision-Avoidance Assist may detect vehicles which are parking or pulling out near your vehicle (example, a vehicle leaving beside your vehicle, a vehicle parking or pulling out in the rear area, a vehicle approaching your vehicle making a turn, etc.). If this occurs, the function may unnecessarily warn the driver and control the brake.

Always check your surroundings while backing up.

- When the vehicle is parked diagonally



Rear Cross-Traffic Collision-Avoidance Assist may be limited when backing up diagonally, and may not detect the vehicle approaching from the left or right. If this occurs, the function may not warn the driver or control the brakes when necessary.

Always check your surroundings while backing up.

- When the vehicle is on or near a slope

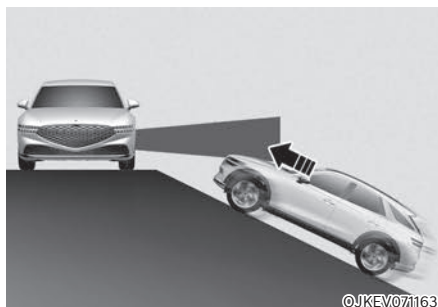

Rear Cross-Traffic Collision-Avoidance Assist may be limited when the vehicle is on an uphill or downhill slope, or near it, and may not detect the vehicle approaching from the left or right. If this occurs, the function may not warn the driver or control the brakes when necessary.

Always check your surroundings while backing up.

- Pulling into the parking space where there is a structure

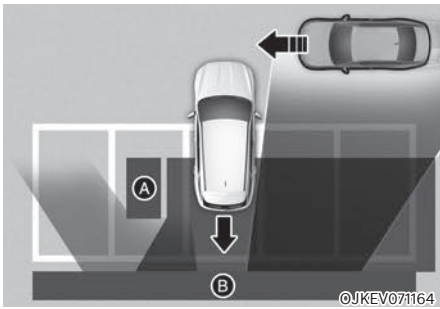

[A]: Structure, [B]: Wall

**Rear Cross-Traffic Collision-Avoidance Assist** may detect vehicles passing by in front of you when parking in reverse into a parking space with a wall or structure in the rear or side area. If this occurs, the function may unnecessarily warn the driver and control the brake.

Always check your surroundings while backing up.

- When the vehicle is parked rearward

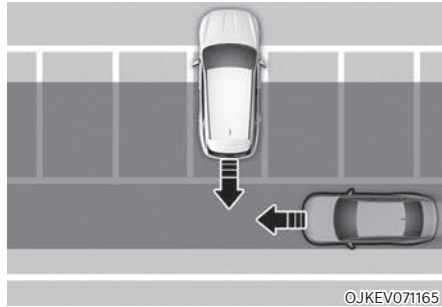

**Rear Cross-Traffic Collision-Avoidance Assist** may detect vehicles passing by behind you when parking in reverse into a parking space. If this occurs, the function may unnecessarily warn the driver and control the brake.

Always check your surroundings while backing up.

 **WARNING**

- When you are towing a trailer or another vehicle, turn off **Rear Cross-Traffic Collision-Avoidance Assist** for safety reasons.
- **Rear Cross-Traffic Collision-Avoidance Assist** may not operate properly if interfered by strong electromagnetic waves.
- **Rear Cross-Traffic Collision-Avoidance Assist** may not operate for 3 seconds after the vehicle is started, or the rear corner radars are initialized.



## FORWARD/REVERSE PARKING DISTANCE WARNING (PDW) (IF EQUIPPED)

Forward/Reverse Parking Distance Warning can help warn the driver if an obstacle is detected within a certain distance when the vehicle is moving forward or in reverse at low speeds.

### Detecting sensor

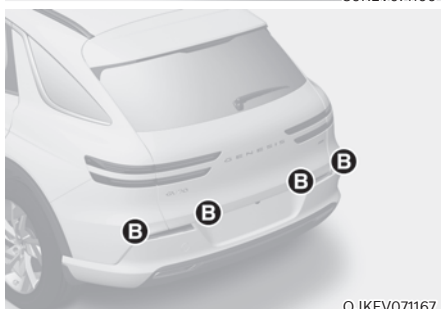

[A]: Front ultrasonic sensors,  
[B]: Rear ultrasonic sensors

Refer to the picture above for the detailed location of the detecting sensors.

## Forward/Reverse Parking Distance Warning settings

### Warning volume

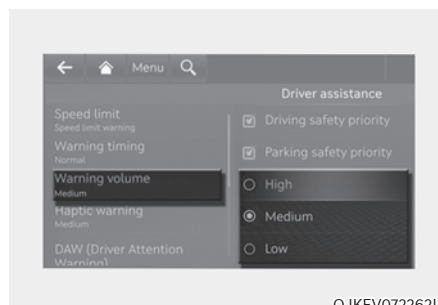

With the vehicle on, select 'Driver assistance → Warning volume' from the Settings menu to change the Warning volume to 'High', 'Medium', 'Low' or 'Off' for Parking Distance Warning.

### *i* Information

- If 'Off' is selected, the Warning volume of Parking Distance Warning will not turn off, but the volume will sound as 'Low'.
- If you change the Warning volume, the Warning volume of other Driver Assistance systems may change.

### **Parking Distance Warning Auto On**

To use Parking Distance Warning Auto On function, select 'Driver assistance → Parking safety → Auto PDW (Parking Distance Warning)' from the infotainment system Settings menu.

#### ***i* Information**

**When Parking Distance Warning Auto On is selected, the Parking Safety button indicator (PWA) stays on.**

### **Parking Distance Warning operation**

#### **Parking Safety button**



- Press the Parking Safety (PWA) button to turn on Forward/Reverse Parking Distance Warning. Press the button again to turn off the function.
- When the gear is shift to R (Reverse), Parking Distance Warning will automatically turn on (Parking Safety button indicator on).
- When the gear is in R (Reverse), Parking Distance Warning does not turn off even if the Parking Safety button (PWA) is pressed.



### **Forward Parking Distance Warning**

Forward Parking Distance Warning will operate under the following conditions.

- The gear is shifted from R (Reverse) to D (Drive) with Reverse Parking Distance Warning on
- The gear is in D (Drive) and the Parking Safety (PWA) button indicator light is on
- 'Auto PDW (Parking Distance Warning)' is selected from the Settings menu and the gear is in D (Drive)

#### ***i* Information**

- **Reverse Parking Distance Warning operates when the vehicle's speed is below 10 km/h (6 mph).**
- **Forward Parking Distance Warning is deactivated if the vehicle speed reaches above 30km/h (18mph). It will not reactivate although the vehicle speed drops below 10km/h (6mph). (Only when Parking Warning Auto On is not selected)**

Distance from object	Warning indicator when driving forward	Warning sound
60–100 cm (24–40 in.)		Buzzer beeps intermittently
30–60 cm (12–24 in.)		Beeps more frequently
within 30 cm (12 in.)		Beeps continuously

- The corresponding indicator will illuminate whenever each ultrasonic sensor detects a person, animal or object in its sensing range. Also an audible warning will sound.
- When more than two objects are detected at the same time, the closest one will be warned with an audible warning.
- The shape of the indicator in the illustration may differ from the actual vehicle.



### Reverse Parking Distance Warning

Reverse Parking Distance Warning will operate under the following conditions.

- The gear is shifted to R (Reverse).

### **i** Information

**Forward Parking Distance Warning operates when the vehicle's speed is below 10 km/h (6 mph).**

Distance from object	Warning indicator when driving backward	Warning sound
60–120 cm (24–48 in.)		Buzzer beeps intermittently
30–60 cm (12–24 in.)		Beeps more frequently
within 30 cm (12 in.)		Beeps continuously

- The corresponding indicator will illuminate whenever each ultrasonic sensor detects a person, animal or object in its sensing range. Also an audible warning will sound.
- When more than two objects are detected at the same time, the closest one will be warned with an audible warning.
- The shape of the indicator in the illustration may differ from the actual vehicle.

## Forward/Reverse Parking Distance Warning malfunction and limitations

### *Parking Distance Warning malfunction*

After starting the vehicle, a beep will sound when the gear is shifted to R (Reverse) to indicate Parking Distance Warning is operating properly.

However, if one or more of the following occurs, first check whether the ultrasonic sensor is damaged or blocked with foreign material. If it still does not work properly, we recommend that the vehicle be inspected by an authorized retailer of Genesis Branded products.

- The audible warning does not sound.
- The buzzer sounds intermittently.
- The 'Ultrasonic sensor error or blockage' warning message appears on the cluster.

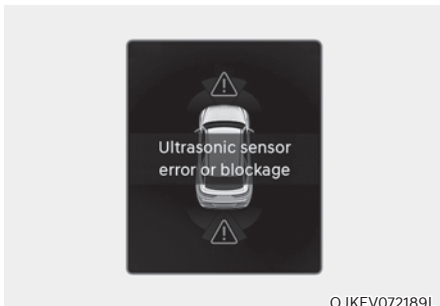

### *Parking Distance Warning disabled*



If this occurs the 'Parking Distance Warning system limited. Ultrasonic sensor blocked' warning message appears on the cluster. Parking Distance Warning will operate properly when snow, rain or foreign material is removed. If Parking Distance Warning does not operate properly after obstruction (snow, rain, or foreign material) is removed (including trailer, carrier, etc., from the rear bumper), we recommend that the vehicle be inspected by an authorized retailer of Genesis Branded products.

### ***Limitations of Parking Distance Warning***

- Parking Distance Warning may not operate properly when:
  - There is excessive moisture or frost on the sensor
  - Sensor is covered with foreign substance, such as snow or water (Parking Distance Warning will operate properly when such substance is removed.)
  - The weather is extremely hot or cold
  - The sensor or sensor assembly is disassembled
  - The surface of the sensor is pressed hard or hit with a hard object
  - The surface of the sensor is scratched with a sharp object
  - The sensors or its surrounding area is directly sprayed with high pressure washer
- Parking Distance Warning may malfunction when:
  - Heavy rain or water spray is present
  - Water flows on the surface of the sensor
  - Affected by another vehicle's sensors
  - The sensor is covered with snow or ice
  - Driving on uneven road, gravel roads or bushes
  - Objects that generates ultrasonic waves are near the sensor
  - License plate is installed in a different spot from the original location
  - The vehicle bumper height or ultrasonic sensor installation has been modified
  - Attaching equipment or accessories next to the ultrasonic sensors
- The following objects may not be detected:
  - Sharp or slim objects, such as ropes, chains or small poles.
  - Narrow objects, such as corners of a square column
  - Objects, which tend to absorb sensor frequency, such as clothes, spongy material or snow.
  - Objects smaller than 100 cm (40 in.) in length and narrower than 14 cm (6 in.) in diameter.
  - Pedestrians, animals or objects that are very close to the ultrasonic sensors
  -



## **WARNING**

- **Parking Distance Warning is a supplemental function. The operation of Parking Distance Warning can be affected by several factors (including environmental conditions). It is the responsibility of the driver to always check the front and rear views before and while parking.**
- **Your new vehicle warranty does not cover any accidents or damage to the vehicle due to the malfunction of Parking Distance Warning.**
- **Pay close attention when driving near objects, pedestrians, and especially children. Some objects may not be detected by the ultrasonic sensors, due to the objects distance, size or material, all of which can limit the effectiveness of the sensor.**
- **Parking Distance Warning does not warn you in the order of detection. It varies depending on the speed of the vehicle or the shape of a person, animal, or object.**
- **If the Parking Distance Warning does not operate properly, we recommend that the vehicle be inspected by an authorized retailer of Genesis Branded products.**

## REVERSE PARKING COLLISION-AVOIDANCE ASSIST (PCA) (IF EQUIPPED)

Reverse Parking Collision-Avoidance Assist can warn the driver or assist with braking to help reduce the possibility of collision with a pedestrian or an object while driving at low speed.

### Detecting sensor

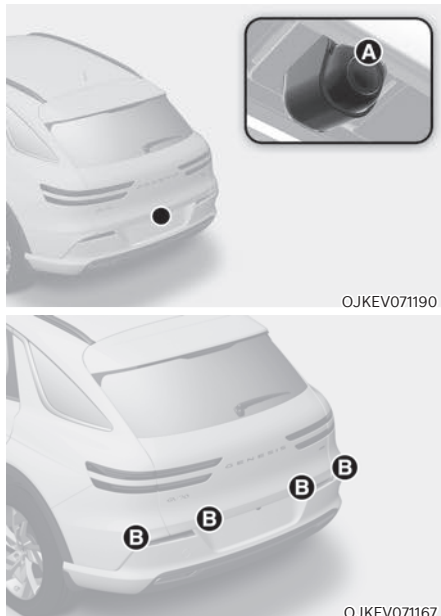

[A]: Wide-rear view camera,  
[B]: Rear ultrasonic sensor

Refer to the picture above for the detailed location of the detecting sensors.

### Reverse Parking Collision-Avoidance Assist settings

#### Parking safety

With the vehicle on, select or deselect 'Driver Assistance → Parking safety' from the Settings menu to set whether to use each function.

- If 'Active rear assist' (or 'Rear Active Assist') is selected, Reverse Parking Collision-Avoidance Assist will warn the driver and assist with braking when a collision with a pedestrian or an object is imminent.
- If 'Rear warning only' is selected, Reverse Parking Collision-Avoidance Assist will warn the driver when a collision with a pedestrian or an object is imminent. Braking will not be assisted.
- If 'Off' is selected, Reverse Parking Collision-Avoidance Assist will turn off.

### Turning Reverse Parking Collision Avoidance Assist On/Off



OJKEV071168

Press and hold the Parking Safety (PWA) button more than 2 seconds, 'Active rear assist' or to turn the Parking Collision-Avoidance Assist on or off.

### Warning timing

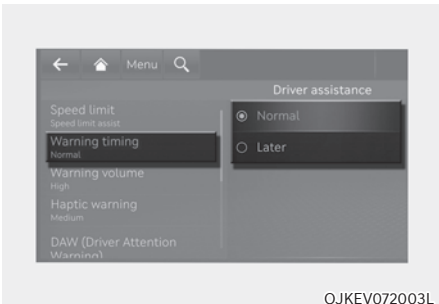

OJKEV072003L

With the vehicle on, select 'Driver assistance → Warning timing' from the Settings menu to change the initial warning activation time for Collision-Avoidance Assist. The warning time can be set to either 'Normal (Standard)' or 'Later'.

- Use 'Normal (Standard)' in normal driving conditions. If the Warning timing seems too sensitive, change it to 'Later'.
- If 'Later' is selected, Parking Collision-Avoidance Assist warns the driver more slowly.

### **i** Information

If you change the Warning timing, the Warning timing of other Driver Assistance systems may change.

### Warning volume

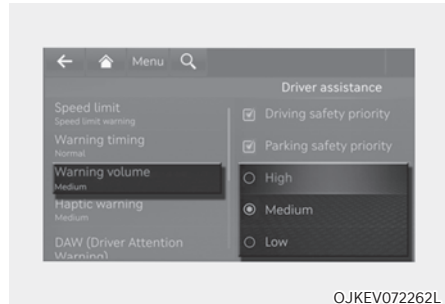

OJKEV072262L

With the vehicle on, select 'Driver assistance → Warning volume' from the Settings menu to change the Warning volume to 'High', 'Medium', 'Low' or 'Off' for Reverse Parking Collision-Avoidance Assist.

### **i** Information

- If 'Off' is selected, the Warning volume of Parking Collision-Avoidance Assist will not turn off, but the volume will sound as 'Low'.
- If you change the Warning volume, the Warning volume of other Driver Assistance systems may change.



## Reverse Parking Collision-Avoidance Assist operation

### Operating conditions

If 'Active rear assist' or 'Rear warning only' is set from the Settings menu, Reverse Parking Collision-Avoidance Assist will be in the ready status when the following conditions are satisfied:

- The tailgate is closed
- The gear is shifted to R (Reverse)
- Vehicle speed is below 10 km/h (6 mph)
- Reverse Parking Collision-Avoidance Assist components such as the rear view camera and the rear ultrasonic sensors are in normal conditions.

When Reverse Parking Collision Avoidance Assist activates, a line appears behind the vehicle image in the instrument cluster. Reverse Parking Collision-Avoidance Assist operates only once after the gear is shifted to R (Reverse). To reactivate Reverse Parking Collision-Avoidance Assist, shift the gear from another gear to R (Reverse).

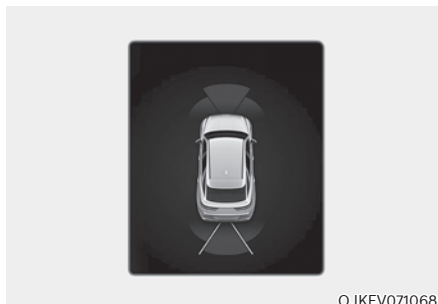

OJKEV071068

### Rear Active Assist

- If Reverse Parking Collision-Avoidance Assist detects a risk of collision with a pedestrian or an object, Reverse Parking Collision-Avoidance Assist will warn the driver with an audible warning and warning message on the cluster. When Rear View Monitor is operating, a warning will appear on the infotainment system screen.
- If Reverse Parking Collision-Avoidance Assist detects an imminent collision with a pedestrian or an object behind the vehicle, Reverse Parking Collision Avoidance Assist will assist you with braking. The driver needs to pay attention and apply the brakes as the brake assist will last for 5 minutes. The driver must immediately depress the brake pedal and check vehicle surroundings.
- Brake control will end when:
  - The gear is shifted to P (Park) or D (Drive).
  - The driver depresses the brake pedal with sufficient power
  - Braking assist has last for approximately 5 minutes

### **i** Information

**Braking control is released after 5 minutes from the initial braking, and Electronic Parking Brake(EPB) is engaged immediately.**

## Reverse Parking Collision-Avoidance Assist malfunction and limitations

### Reverse Parking Collision-Avoidance Assist malfunction



When Reverse Parking Collision-Avoidance Assist or other related functions are not working properly, the 'Check Parking Safety system' warning message will appear on the cluster, and Reverse Parking Collision-Avoidance Assist will turn off automatically. We recommend that the vehicle be inspected by an authorized retailer of Genesis Branded products.

## Reverse Parking Collision-Avoidance Assist disabled

### Detecting sensors



[A]: Wide angle-rear view camera

The wide angle cameras are used as detecting sensors to detect pedestrians. If the camera lens is covered with foreign material, such as snow or rain, it may adversely affect camera performance and Parking Collision-Avoidance Assist may not operate properly. Always keep the camera lens clean.

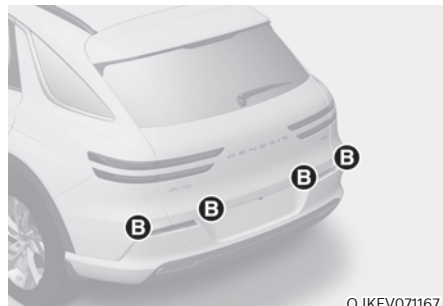

[B]: Rear ultrasonic sensor

The ultrasonic sensors detect objects around the vehicle. If the sensors are covered with foreign material, such as snow or rain, it may adversely affect sensor performance and Parking Collision-Avoidance Assist may not operate properly. Always keep the rear bumper clean.

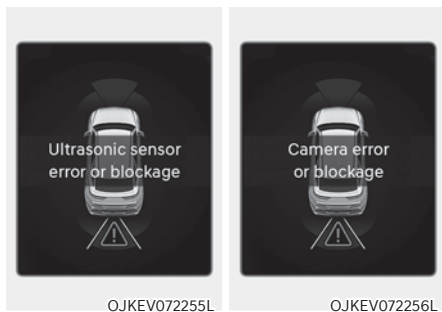

[A]: Camera, [B]: Ultrasonic sensor

### Warning message

The 'Camera error or blockage' or 'Ultrasonic sensor error or blockage' warning message will appear on the cluster if the following situations occur:

- The camera(s) or ultrasonic sensor(s) is covered with foreign material, such as snow or rain, etc.
- There is inclement weather, such as heavy snow, heavy rain, etc.

If this occurs, Reverse Parking Collision-Avoidance Assist may turn off or may not operate properly. Check whether the cameras and ultrasonic sensors are clean.

### Limitations of Reverse Parking Collision-Avoidance Assist

Reverse Parking Collision-Avoidance Assist may not assist braking or warn the driver even if there are pedestrians or objects under the following circumstances:

- Problems with vehicle
  - Any non-factory equipment or accessory is installed
  - Your vehicle is unstable due to an accident or other causes
  - Bumper height or rear ultrasonic sensor installation has been modified
  - Wide-rear view camera(s) or ultrasonic sensor(s) is damaged
  - Wide-rear view camera(s) or the ultrasonic sensor(s) is stained with foreign material, such as snow, dirt, etc.
  - Wide-rear view camera(s) is obscured by a light source or by inclement weather, such as heavy rain, fog, snow, etc.

- Problems with the surroundings
  - The surrounding is very bright or very dark
  - Outside temperature is very high or very low
  - The wind is either strong (above 20 km/h (12 mph)) or blowing perpendicular to the rear bumper
  - Objects generating excessive noise, such as vehicle horns, loud motorcycle vehicles or truck air brakes, are near your vehicle
  - An ultrasonic sensor with similar frequency is near your vehicle
  - The road is slippery or inclined
  - The image of the pedestrian in the front view camera is indistinguishable from the background
- Problems with pedestrian or object
  - The pedestrians are difficult to detect
  - There is ground height difference between the vehicle and the pedestrian
  - The pedestrian is near the rear edge of the vehicle
  - The pedestrian is not standing upright
  - The pedestrian is either very short or very tall to detect
  - The pedestrian or cyclist is wearing clothing that easily blends into the background, making it difficult to detect
  - The pedestrian is wearing clothing that does not reflect ultrasonic waves well
  - Size, thickness, height, or shape of the object does not reflect ultrasonic waves well (for example, low object, narrow object, circular pillar, small pillar, corners of a square pillar, bush, curbs, carts, edge of a wall, etc.)
  - The pedestrian or the object is moving
  - The pedestrian or the object is very close to the rear of the vehicle
  - There is a large object such as a wall is behind the pedestrian or the object
  - The object is not located at the front or rear center of your vehicle
  - The object is not parallel to the rear bumper
  - The sensors cannot detect the pedestrians and objects

- Problems with driving condition
  - The driver drives the vehicle immediately after shifting to R (Reverse) or D (Drive)
  - The driver accelerates or circles the vehicle
  - The vehicle is driven immediately after starting the vehicle

Reverse Parking Collision-Avoidance Assist may unnecessarily warn the driver or assist with braking even if there are no pedestrians or objects under the following circumstances:

- Problems with vehicle
  - Any non-factory equipment or accessory is installed
  - Your vehicle is unstable due to an accident or other causes
  - Bumper height or rear ultrasonic sensor installation has been modified
  - Your vehicle height is low or high due to heavy loads, abnormal tire pressure, etc.
  - Wide-rear view camera(s) or the rear ultrasonic sensor(s) is stained with foreign material, such as snow, dirt, etc.
- Problems with the surroundings
  - The pattern on the road is mistaken for a pedestrian
  - There is shadow or light reflecting on the ground
  - Pedestrians or objects are around the path of the vehicle
  - Objects generating excessive noise, such as vehicle horns, loud motorcycle vehicles or truck air brakes, are near your vehicle
  - Your vehicle is backing towards a narrow passage or parking space
  - Your vehicle is backing towards an uneven road surface, such as an unpaved road, gravel, bump, gradient, etc.
  - A trailer or carrier is installed on the rear of your vehicle
  - An ultrasonic sensor with similar frequency is near your vehicle
- Problems with pedestrian or object
  - The pedestrian or the object is moving
- Problems with driving condition
  - The driver accelerates or circles the vehicle
  - The vehicle moves forward and backward repeatedly



## WARNING

Take the following precautions when using Reverse Parking Collision-Avoidance Assist:

- Always exercise extreme caution while driving. The driver is responsible for braking and safe driving.
- Always pay attention to road and traffic conditions while driving, whether or not there is a warning.
- Always look around your vehicle to make sure there are no pedestrians or objects before moving the vehicle.
- The performance of Reverse Parking Collision-Avoidance Assist may vary under certain conditions. If vehicle speed is above 4 km/h (2 mph), Reverse Parking Collision-Avoidance Assist will provide collision avoidance assist only when pedestrians are detected. Always look around and pay attention when driving your vehicle.
- Reverse Parking Collision-Avoidance Assist may operate differently under certain conditions. If the vehicle moves forward and backward repeatedly, Reverse Parking Collision-Avoidance Assist may fail to assist braking or to warn the driver. Always pay attention when driving your vehicle.
- Some objects may not be detected by the rear ultrasonic sensors due to the objects distance, size or material, all of which can limit the effectiveness of the sensor.

- Reverse Parking Collision-Avoidance Assist may not operate properly or may operate unnecessarily depending on the road conditions and the surroundings.
- Do not solely rely on Parking Collision-Avoidance Assist. Doing so may lead to vehicle damage or injuries.



## CAUTION

- Noise may be heard when sudden braking occurs to avoid a collision.
- If any other warning sound such as the seat belt warning chime is already generated, Parking Collision-Avoidance Assist warning may not sound.
- Parking Collision-Avoidance Assist may not work properly if the bumper has been damaged, replaced or repaired.
- Parking Collision-Avoidance Assist may not operate properly if interfered by strong electromagnetic waves.
- Playing the vehicle audio system at high volume may prevent passengers from hearing Parking Collision-Avoidance Assist warning sounds.
- Turn off Parking Collision-Avoidance Assist when towing a trailer. If towing and moving in reverse, Parking Collision-Avoidance Assist will activate as it detects the trailer.
- The brake control may not operate properly depending on the status of ESC (Electronic Stability Control).  
There will only be a warning when:
  - The ESC (Electronic Stability Control) warning light is on
  - ESC (Electronic Stability Control) is engaged in a different function



## CAUTION

Take the following precautions to maintain optimal performance of the detecting sensors:

- Always keep the wide-rear view cameras and ultrasonic sensors clean.
- Do not use any cleanser containing acid or alkaline detergents when cleaning the camera lens. Use only a mild soap or neutral detergent, and rinse thoroughly with water.
- Do not spray the wide-rear view cameras or the rear ultrasonic sensors or their surrounding area directly with a high pressure washer. It may cause the wide angle cameras or the ultrasonic sensors to malfunction.
- Do not apply objects, such as a bumper sticker or a bumper guard, near the wide angle cameras or ultrasonic sensors or apply paint to the bumper. Doing so may adversely affect the performance of Parking Collision-Avoidance Assist.
- Never disassemble or apply impact on the wide angle cameras or the ultrasonic sensors components.
- Do not apply unnecessary force on the wide-rear view cameras or the ultrasonic sensors. Reverse Parking Collision-Avoidance Assist may not operate properly if the wide angle cameras or the ultrasonic sensor(s) is forcibly moved out of proper alignment. We recommend that the vehicle be inspected by an authorized retailer of Genesis Branded products.



## Information

Reverse Parking Collision-Avoidance Assist can detect a pedestrian or an object when:

- A pedestrian is standing behind the vehicle
- A large obstacle, such as a vehicle, is parked in the rear center of your vehicle

## REMOTE SMART PARKING ASSIST (RSPA) (IF EQUIPPED)

Remote Smart Parking Assist uses vehicle sensors to help the driver park and exit parking spaces remotely from outside the vehicle by controlling the steering wheel, vehicle speed, and gearshifts

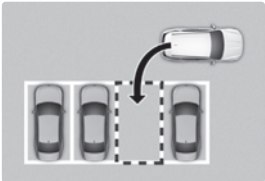
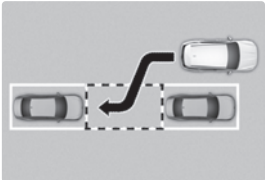
Function	Description
Remote Operation	<p>Remotely moving forward or backward</p>  <p>OJKEV071169</p>
Smart Parking or Remote Smart Parking	<p>Perpendicular reverse parking</p>  <p>OJKEV071170</p>
	<p>Parallel reverse parking</p>  <p>OJKEV071171</p>

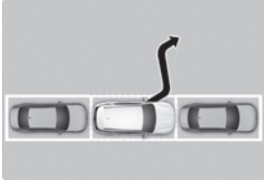
Function	Description
Smart Exit	<p>Parallel forward exit</p>  <p>OJKEV071172</p>

- Remote Smart Parking and Remote Operation function may be operated from outside the vehicle using the smart key.
- Smart Parking and Remote Smart Parking function may be operated from inside the vehicle.
- Smart Parking and Remote Smart Parking function helps the driver with perpendicular reverse parking, diagonal reverse parking and parallel reverse parking.
- Smart Exit function helps the driver with parallel forward exit.
- When Remote Smart Parking Assist operates, Parking Distance Warning, and Surround View Monitor will also operate. For more details, refer to “Parking Distance Warning (PDW)” and “Surround View Monitor (SVM)” sections in this chapter.



## Detecting sensors

### Ultrasonic sensors

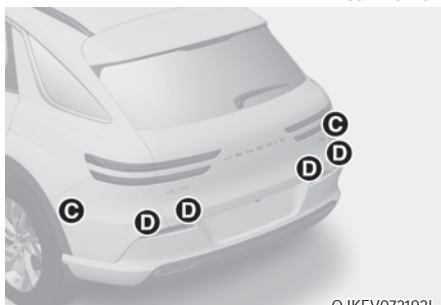
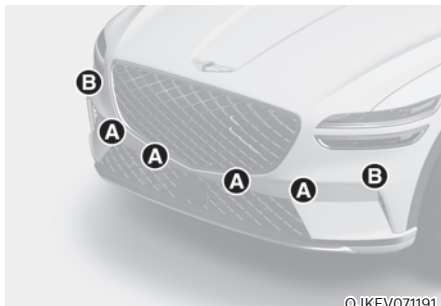

- [A]: Front ultrasonic sensors,  
 [B]: Front corner ultrasonic sensors,  
 [C]: Rear corner ultrasonic sensors,  
 [D]: Rear ultrasonic sensors

Refer to the picture above for the detailed location of the detecting sensors.



### CAUTION

Take the following precautions to maintain optimal performance of the detecting sensors:

- Never disassemble the detecting sensor or sensor assembly, or cause any damage to it.
- If the detecting sensors need repair, we recommend that you have your vehicle inspected by an authorized retailer of Genesis Branded products.
- Remote Smart Parking Assist may malfunction if the vehicle bumper height or ultrasonic sensor installation has been modified or damaged. Any non-factory installed equipment or accessories may also interfere with the sensor performance.
- When the ultrasonic sensor is frozen or stained with snow, dirt, or water, the sensor may not operate until the stains are removed using a soft cloth.
- Do not push, scratch, or strike the ultrasonic sensor. Sensor damage could occur.
- Do not spray the ultrasonic sensors or its surrounding area directly with a high pressure washer.

## Remote Smart Parking Assist settings

### Settings features

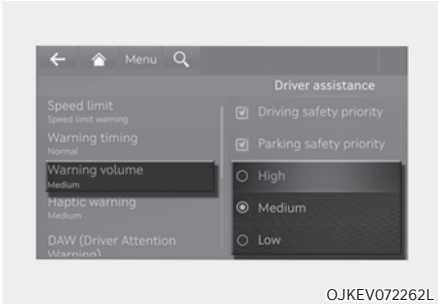

### Warning volume

With the vehicle on, select 'Driver assistance → Warning volume' from the Settings menu to change the Warning volume to 'High', 'Medium', 'Low' or 'Off' for Remote Smart Parking Assist.





### **i** Information

- **If 'Off' is selected, the Warning volume of Remote Smart Parking Assist will not turn off, but the volume will sound as 'Low'.**
- **If you change the Warning volume, the Warning volume of other Driver Assistance systems may change**

## Remote Smart Parking Assist operation

### Remote Smart Parking Assist button

Parking/View button, Parking Safety button	Smart key
 <p data-bbox="283 667 379 683">OJKEV071153</p>	 <p data-bbox="524 667 626 683">OJKEV071168</p>
 <p data-bbox="971 651 1067 667">OJKEV071193</p>	

Location	Name	Symbol	Description
Inside vehicle	Parking/View button		<ul style="list-style-type: none"> <li>Press and hold the Parking/View button to turn on Remote Smart Parking Assist. Also, Forward/Reverse Parking Distance warning will automatically turn on.</li> <li>However, functions may differ depending on the situations. Refer to each function's description for more details in the following pages.</li> <li>Press and hold the Parking/View button while Smart Parking or Smart Exit function is on to operate the function.</li> </ul>
	Parking Safety button		<ul style="list-style-type: none"> <li>Press the Parking Safety button while Remote Smart Parking Assist is operating to end Remote Smart Parking Assist operation.</li> </ul>
Smart key	Remote Start button		<ul style="list-style-type: none"> <li>Press the Remote Start button after the door is locked with the vehicle off to start the vehicle remotely.</li> <li>Press the Remote Start button while Remote Smart Parking or Remote Operation function is operating to end function operation.</li> </ul>
	Forward button		<ul style="list-style-type: none"> <li>When using Remote Smart Parking function, regardless of which direction button is pressed, parking is supported while the button is pressed.</li> </ul>
	Backward button		<ul style="list-style-type: none"> <li>When using the Remote Operation function, the vehicle moves in the direction of the button while the button is pressed.</li> </ul>

## Remote Operation

### Operating order

Remote Operation functions in the following order:

1. Getting ready to remotely move forward and backward
2. Remotely moving forward and backward

### 1. Getting ready to remotely move forward and backward

There are two ways to operate Remote Operation function.

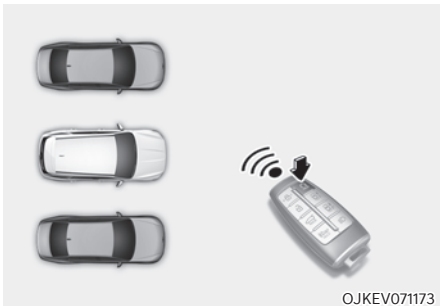

Method (1) Using the function with vehicle off

- (1) Within a certain range from the vehicle press the door lock (🔒) button on the smart key and lock all doors.
- (2) Press and hold the Remote Start button (🔑<sub>HOLD</sub>) within 4 seconds until the vehicle starts.

For more details on remotely starting the vehicle, refer to “Remote Start” section in chapter 6.

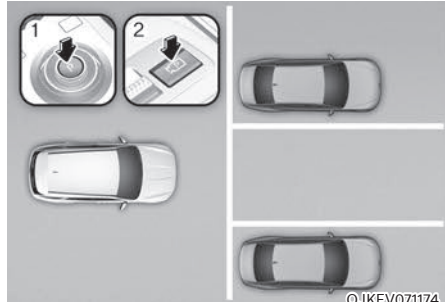

Method (2) Using the function with vehicle on

- (1) Park the vehicle in front of the space where you want to use Remote Operation function, and shift the gear to P (Park).
- (2) Press and hold the Parking/View Assist (P) button to turn on Smart Parking Assist. A message ‘Remote Parking Instructions’ will appear on the infotainment system screen.
- (3) Get out of the vehicle with the smart key and close all doors.

- 'Agree' must be selected on the infotainment system screen and the infotainment system has to operate properly to use Remote Operation function.
- Method (2) can be used after the vehicle has been driven above 5 km/h (3 mph).
- If the function is turned on again after parking is completed by Remote Smart Parking Assist, Remote Operation function can be used with Method (2).
- Check that all smart keys are outside the vehicle when using Remote Operation function.

## 2. Remotely moving forward and backward

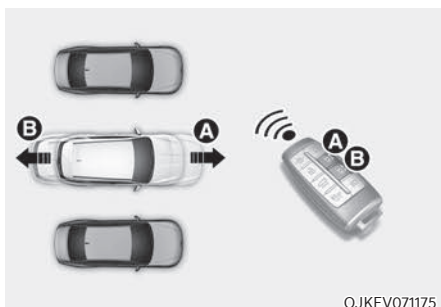

- (1) Press and hold one of the Forward (⏪) or Backward (⏩) button on the smart key. Remote Smart Parking Assist will automatically control the steering wheel, vehicle speed and gearshift. The vehicle will move in the direction of the button pressed.
  - (2) While Remote Operation function is operating, if you do not hold down the Forward (⏪) or Backward (⏩) button, the vehicle will stop and function control will pause. The function will start operating again when the button is pressed and held again.
  - (3) When the vehicle reaches the target location, release the smart key Forward or Backward button.
  - (4) When the driver gets in the vehicle with the smart key, a message will appear informing the driver Remote Operation function is complete on the infotainment system screen and the vehicle will remain on.
- In addition, when the Remote Start (⏻) button is pressed on the smart key from outside the vehicle, a message will appear informing the driver Remote Operation function is complete and the vehicle will turn off.

 **Information**

- Check that all smart keys are outside the vehicle when using Remote Operation function.
- Remote Operation function will operate only when the smart key is within 4 m (13 ft.) from the vehicle. If there is no vehicle movement even when the Forward or Backward button is pressed on the smart key, check the distance to the vehicle and press the button again.
- The detecting range of the smart key may vary depending on the surroundings that are affected by radio waves such as transmission tower, broadcast station, etc.
- When remotely moving forward using method (1), it is recognized as an exit situation, and the vehicle moves 4 m (13 ft.) to check for parking lines, pedestrians, animals or objects around the vehicle. After confirmation, the steering wheel is controlled according to the condition ahead.
- When remotely moving forward using method (2), it is recognized as a parking situation, and will immediately control the steering wheel according to the condition ahead to assist with entering the parking space and aligning the vehicle. However, performance may reduce depending on the parking lines pedestrians, animals, shape of objects, location, etc., around the vehicle.
- For moving remotely backward, both method (1) and (2) aligns the steering wheel first, and then will only move the vehicle straight.
- When remotely moving forward or backward is completed, the vehicle will automatically shift to P (Park) and engage EPB (Electronic Parking Brake).

 **CAUTION**

- When using Remote Operation function, make sure that all passengers have gotten out of the vehicle.
- If the vehicle's battery is discharged or Remote Smart Parking Assist malfunctions when parked in a narrow parking space, Remote Operation function will not operate. Always park your vehicle in a space wide enough for you to get in or out of your vehicle.
- Depending on the parking space, you may not be able to exit from the space you have entered by using Remote Operation function.
- After parking, the surrounding may change due to the movement of surrounding vehicles. If this occurs, Remote Operation function may not operate.
- Before leaving the vehicle, close windows and sunroofs, and make sure the vehicle is off before locking the doors.

### Remote Operation function operation status

Operation status	Smart key LED	Hazard warning light
Under control	Green LED continuously blinks	-
Pause	Red LED continuously blinks	Blinks
Off	Red LED illuminates for 4 seconds and then turns off	Blinks 3 times and turns off
Complete	Green LED illuminates for 4 seconds and then turns off	Blinks 1 time and turns off

\* Operation status by the hazard warning light may not be applicable based on the regulation of your country.

\* If the smart key is not within the operating range from the vehicle (approximately 4m (13 ft.)), the smart key LED will not illuminate or blink. Use the smart key within the operating range.

### How to turn off Remote Operation function while operating

- Press the Parking/View (P) button while the infotainment system screen guides the driver using method 2.
- Shift the gear from P (Park) to any other position while the infotainment system screen guides the driver using method 2.
- Press the Parking Safety (P) button or select 'Cancel' on the infotainment system screen.
- Press the Remote Start (HOLD) button on the smart key while the vehicle is being controlled by Remote Operation function. Remote Operation function will turn off. At this time, the vehicle will turn off.
- Get on the vehicle with the smart key. Remote Operation function will turn off. At this time, the vehicle will remain on.

### The function will pause in the following conditions when:

- There is a pedestrian, animal or object in the direction the vehicle is moving
- The door or tailgate is open
- The Forward (F) or Backward (B) button is not continuously pressed
- Simultaneously pressing multiple buttons on a smart key
- The smart key is not operated within 4 m (13 ft.) from the vehicle
- Button of another smart key is pressed in addition to the operating smart key
- Blind-Spot Collision-Avoidance Assist or Rear Cross-Traffic Collision-Avoidance Assist operates while the vehicle is being controlled in the reverse direction.

- The vehicle moves 7 m (22 ft.) while the smart key is pressed with Remote Operation function (maximum travel distance per button press)

When Remote operation function is paused, the vehicle will stop. If the condition that made the function to pause disappears, the function may operate again.

**The function will cancel in the following conditions when:**

- The steering wheel is steered
  - The gear is shifted while the vehicle is moving
  - Operating EPB while the vehicle is moving
  - The hood is open
  - The brake pedal or accelerator pedal is depressed when all the doors are closed
  - The smart key is outside the vehicle when the brake pedal is depressed while the driver's door is open
  - Rapid acceleration occurs
  - Vehicle skid occurs
  - The wheel is stuck by an obstacle and cannot move
- Approximately 3 minutes and 50 seconds have past after Remote Operation function has started to operate
  - The slope of the road exceeds the operational range
  - The function is paused for more than 1 minute
  - The total travel distance of the vehicle has exceeded 14 m (45 ft.) after Remote Operation function operation
  - The steering wheel, gearshift, braking, and drive controls are not working properly
  - There is a problem with the smart key or the smart key battery is low
  - ABS, TCS or ESC system operates due to slippery road conditions
  - The alarm of the Theft Alarm System sounds
  - The charging door is open

When Remote Operation function is cancelled, the vehicle will automatically stop, shift the gear to P (Park) and engage EPB (Electronic Parking Brake).



## Smart Parking, Remote Smart Parking

### Operating order

Parking function operates in the following order:

1. Getting ready for parking
2. Searching for parking space
3. Select parking type and operating mode
4. Smart Parking
5. Remote Smart Parking

### 1. Getting ready for parking

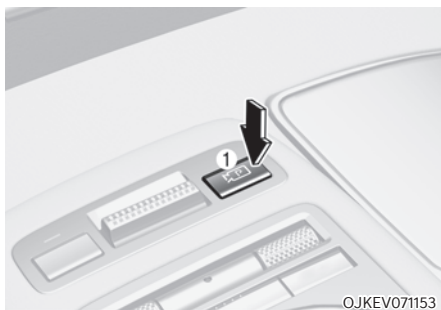

OJKEV071153

- (1) With the vehicle turned on, depress the brake pedal and shift the gear to D (Drive) or N (Neutral).
- (2) Press and hold the Parking/View (P) button to turn on Remote Smart Parking Assist.

### **i** Information

- 'Agree' must be selected on the infotainment system screen and the infotainment system has to operate properly to use Parking function.
- If you drive above 5 km/h (3 mph) with the vehicle on, you may use the Parking function with the gear shifted to N (Neutral).

### 2. Searching for parking space

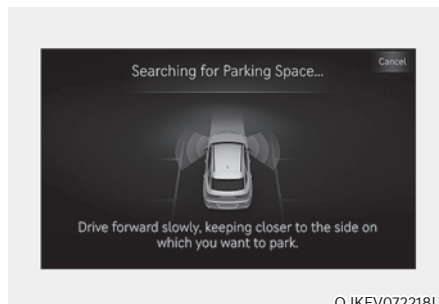

OJKEV072218L

- (1) Slowly drive forward maintaining the distance of approximately 40 in. (100 cm) from the parking lines or parked vehicle.
- (2) When searching for a parking space is complete, a message will appear on the infotainment system screen with an audible sound to notify the search is complete.
- (3) 'Select Parking Type' will be displayed on the infotainment system screen and the selected parking space will appear on the screen of Surround View Monitor.

- Remote Smart Parking Assist searches parking lines or parking spaces that are next to parked vehicles. Remote Smart Parking Assist cannot search parking spaces in front or rear of the vehicle.
- While searching for a parking space, when vehicle speed is above 20 km/h (12 mph), a message will appear on the infotainment system screen informing you to slow down. When vehicle speed is above 30 km/h (18 mph), Parking function will turn off.
- Searching for a parking space will be completed when there is enough space to move the vehicle in addition to the parking space.
- Even if an audible sound is heard to notify that searching for a parking space is complete, search completion can be cancelled immediately depending on surroundings.

**i** Information

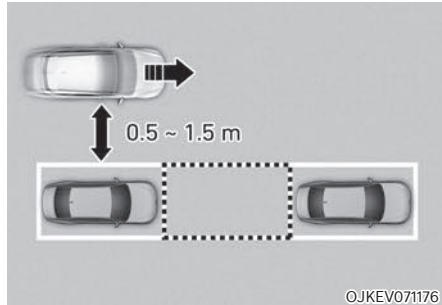

- **If the distance is below 50 cm (20 in.) or over 150 cm (59 in.), Remote Smart Parking Assist may not be able to search for a parking space.**
- **If you do not maintain a certain distance from the parked vehicle, the performance to search for a parking space may reduce.**
- **Due to abnormal performance of the ultrasonic sensor or the influence of the surroundings, Parking function may not be able to search for a parking space even if there is a parking space, or may search for a space that is not suitable for parking.**
- **If the parking space is on an incline or is diagonal, the parking type displayed may be different from the actual parking type which should be selected. If this occurs, do not select the parking type, and search for another parking space.**

### 3. Select parking type and operating mode



OJKEV072219L

- (1) Parking type – Perpendicular reverse (Left/Right), Parallel reverse (Left/Right)

With the vehicle stopped by depressing the brake pedal, touch the infotainment system screen or use the central controller to select the desired parking type.

#### **i** Information

- If you continue to drive without stopping after the parking type selection screen appears, Remote Smart Parking Assist will return to the previous stage and search for a parking space.
- If Parking function is cancelled unintentionally by pressing the Parking/View (**P**) button before the parking type is selected, you can return to the parking type selection stage by pressing and holding the button again while the vehicle is stopped.

#### **!** CAUTION

Before selecting the Parking type, the driver should check whether the parking space is suitable.

If the searched parking space by Remote Smart Parking Assist is narrow or unsuitable for parking, do not select the Parking type and move the vehicle to search for another parking space.

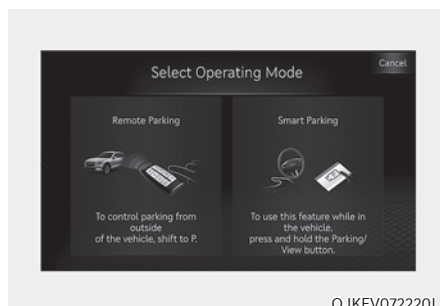

OJKEV072220L

- (2) Operating mode – Remote Parking, Smart Parking

After selecting a parking type, the infotainment system screen will guide you with Remote Smart Parking function and Smart Parking function. Follow the instructions to operate Remote Smart Parking Assist.

#### **i** Information

- Operating instructions will be displayed on the screen for each desired function you select.
- Do not take your foot off the brake pedal during the Parking function guide. When the vehicle moves, Remote Smart Parking Assist will turn off.

**i** Information



**If Remote Smart Parking Assist cannot activate Remote Smart Parking function, only the Smart Parking guide will be displayed on the infotainment system screen.**

**4. Smart Parking**

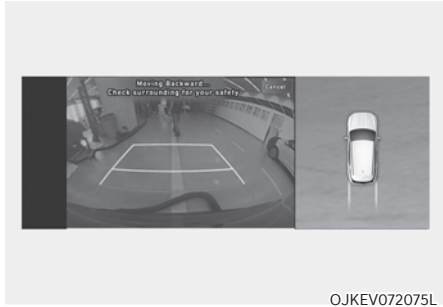
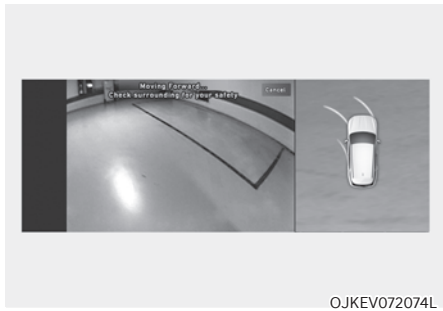

- (1) Press the Parking/View (P) button when the vehicle is stopped by depressing the brake pedal. When the brake pedal is released, Remote Smart Parking Assist will automatically control the steering wheel, vehicle speed and gearshift.
- (2) While Smart Parking function is operating, if you do not hold down the Parking/View button, the vehicle will stop and function control will pause. The function will start operating again when the Parking/View button is pressed and held again.

- (3) When the vehicle reaches the target parking position, a message will appear on the infotainment system screen to inform you that parking is complete.
- (4) If you need to change the vehicle's position or location, manually complete parking your vehicle.

### **i** Information

- **Smart Parking function will not operate if the door is open or the seat belt is not fastened.**
- **The parking location indicator is displayed on Surround View Monitor screen and is displayed until the vehicle enters the parking space for the first time by Smart Parking function.**
- **Vehicle speed can be adjusted by depressing the brake pedal while Smart Parking function is operating. However, the vehicle does not accelerate even when the accelerator pedal is depressed.**
- **Depending on parking environments, if the vehicle is stopped by a stopper, parking may be completed.**
- **If you need to change the vehicle's position or location, manually complete parking your vehicle.**

## 5. Remote Smart Parking

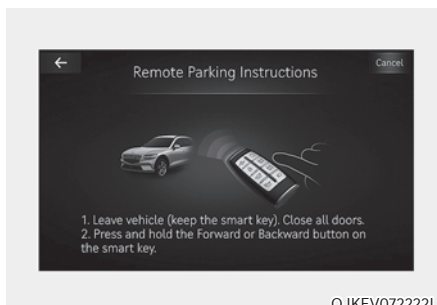

- (1) Shift the gear to P (Park), get out of the vehicle with the smart key, and close all doors.
- (2) Press and hold one of the Forward (⬆) or Backward (⬇) button on the smart key. Remote Smart Parking Assist will automatically control the steering wheel, vehicle speed and gearshift.
- (3) While Remote Smart Parking function is operating, if you do not hold down the Forward (⬆) or Backward (⬇) button, the vehicle will stop and function control will pause. The function will start operating again when the button is pressed and held again.
- (4) When the vehicle reaches the target parking position, a message will appear on the infotainment system screen to inform you that parking is complete. The vehicle will automatically shift to P (Park), engage EPB (Electronic Parking Brake) and the vehicle will turn off.
- (5) If you need to change the vehicle's position or location, manually complete parking your vehicle.

***i*** Information

- When operating Remote Smart Parking function, make sure all smart keys are outside of the vehicle.
- Remote Smart Parking function will operate only when the smart key is within 4 m (13 ft.) from the vehicle. If there is no vehicle movement even when the Remote Forward or Backward button is pressed on the smart key, check the distance to the vehicle and press the button again.
- The detecting range of the smart key may vary depending on the surroundings that are affected by radio waves such as transmission tower, broadcast station, etc.
- The parking location indicator is displayed on Surround View Monitor screen and is displayed until the vehicle enters the parking space for the first time by Remote Smart Parking function.
- Depending on parking environments, if the vehicle is stopped by a stopper, parking may be completed.
- If you need to change the vehicle's position or location, manually complete parking your vehicle.

** CAUTION**

- When using Remote Smart Parking function, make sure that all passengers have gotten out of the vehicle.
- After ending or turning off Remote Smart Parking function, before leaving the vehicle, close windows and sunroofs, and make sure the vehicle is off before locking the doors.

**Parking function operation status**

- Smart Parking function

Operation status	Turn signal
Under control	The turn signal of the parking direction blinks until the first reverse is complete.

- Remote Smart Parking function

Operation status	Smart key LED	Hazard warning light	Turn signal
Under control	Green LED continuously blinks	-	The turn signal of the parking direction blinks until the first reverse is complete.
Pause	Red LED continuously blinks	Blinks	-
Off	Red LED illuminates for 4 seconds and then turns off	Blinks 3 times and turns off	-
Complete	Green LED illuminates for 4 seconds and then turns off	Blinks 1 time and turns off	-

- \* Operation status by the hazard warning light and turn signal may not be applicable based on the regulation of your country.
- \* If the smart key is not within the operating range from the vehicle (approximately 4m (13 ft.)), the smart key LED will not illuminate or blink. Use the smart key within the operating range.

**The function will pause in the following conditions when:**

- Smart Parking
  - There is a pedestrian, animal or object in the direction the vehicle is moving
  - The door or tailgate is open
  - The driver's seat belt is not fastened
  - Blind-Spot Collision-Avoidance Assist or Rear-Cross Traffic Collision-Avoidance Assist operates while the vehicle is being controlled in the reverse direction
  - The Parking/View (P) button is not continuously pressed
  - The vehicle is stopped by depressing the brake pedal
  
- Remote Smart Parking
  - There is a pedestrian, animal or object in the direction the vehicle is moving
  - The door or tailgate is open
  - The Forward (F) or Backward (B) button is not continuously pressed
  - Simultaneously pressing multiple buttons on a smart key
  - The smart key is not operated within 4 m (13 ft.) from the vehicle
  - Button of another smart key is pressed in addition to the operating smart key
  - Blind-Spot Collision-Avoidance Assist or Rear-Cross Traffic Collision-Avoidance Assist operates while the vehicle is being controlled in the reverse direction

When Parking function is paused, the vehicle will automatically stop. If the condition that made the function to pause disappears, the function may operate again.

**How to turn off Parking function while operating**

- Press the Parking/View (P) button in the following stage:
  - Searching for parking space
  - Select parking type
- Shift the gear to R (Reverse) in the following stage:
  - Searching for parking space
  - Select parking type
  - Select operating mode
- Press the Parking Safety (P) button or select 'Cancel' on the infotainment system screen to turn off Parking function.
- While Smart Parking function is operating:
  - If the vehicle is stopped by depressing the brake pedal, and the gear is shifted, Parking function will turn off. At this time, EPB (Electronic Parking Brake) will not be engaged.
- While Remote Smart Parking function is operating:
  - Press the Remote Start (HOLD) button on the smart key. Parking function will turn off.
  - Get on the vehicle with the smart key. Parking function will turn off. At this time, the vehicle will remain on.



***The function will cancel in the following conditions when:***

- Smart Parking
  - The steering wheel is steered
  - The gear is shifted while the vehicle is moving
  - Operating EPB while the vehicle is moving
  - The hood is open
  - The driver opens the door with the seatbelt unfastened
  - Rapid acceleration occurs
  - Vehicle skid occurs
  - The wheel is stuck by an obstacle and cannot move
  - There are pedestrians, animals or objects at the front and rear of the vehicle at the same time
  - Approximately 3 minutes and 50 seconds have past after Smart Parking function has started to operate
  - The slope of the road exceeds the operational range
  - The function is paused for more than 1 minute
  - The steering wheel, gearshift, braking, and drive controls are not working properly
  - ABS, TCS or ESC system operates due to slippery road conditions
  - The charging door is open
- Remote Smart Parking
  - The steering wheel is steered
  - The gear is shifted
  - Operating EPB while the vehicle is moving
  - The hood is open
  - The brake pedal or accelerator pedal is depressed when all the doors are closed
  - The smart key is outside the vehicle when the brake pedal is depressed while the driver's door is open.
  - Rapid acceleration occurs
  - Vehicle skid occurs
  - The wheel is stuck by an obstacle and cannot move
  - There are pedestrians, animals or objects at the front and rear of the vehicle at the same time
  - Approximately 3 minutes and 50 seconds have past after Remote Smart Parking function has started to operate
  - The slope of the road exceeds the operational range
  - The function is paused for more than 1 minute
  - The steering wheel, gearshift, braking, and drive controls are not working properly
  - There is a problem with the smart key or the smart key battery is low
  - ABS, TCS or ESC system operates due to slippery road conditions
  - The alarm of the Theft Alarm System sounds
  - The charging door is open

When Smart Parking function is cancelled, the vehicle will automatically stop, shift the gear to P (Park) and engage EPB (Electronic Parking Brake).

When Remote Smart Parking function is cancelled, the vehicle will automatically stop, shift the gear to P (Park) and engage EPB (Electronic Parking Brake).

## Smart Exit

### Operating order

Smart Exit function operates in the following order:

1. Getting ready for exit
2. Checking space
3. Select exit direction
4. Smart Exit

### 1. Getting ready for exit

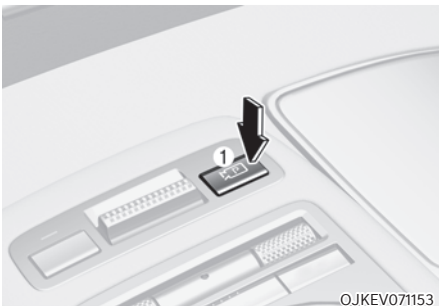

- (1) With the vehicle turned on, depress the brake pedal and shift the gear to P (Park) or N (Neutral).
- (2) Press and hold the Parking/View (P) button to turn on Remote Smart Parking Assist.

### Information

- 'Agree' must be selected on the infotainment system screen and the infotainment system has to operate properly to use Smart Smart Exit function.
- Drive below 5 km/h (3 mph) with the vehicle on and shift the gear to N (Neutral), Smart Exit function can be used.
- If the function is turned on again after parallel parking is completed by Remote Smart Parking Assist, Smart Exit function can be used.

### 2. Checking space

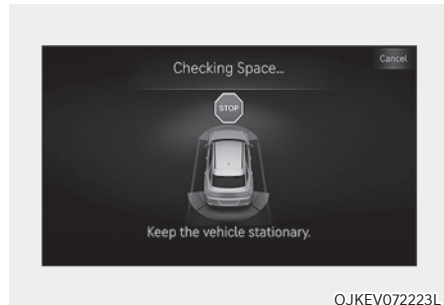

- (1) When the vehicle is stopped by depressing the brake pedal, the vehicle sensors will detect the distance from nearby objects and check for space to exit.
- (2) When checking for space is complete, a message will appear on the infotainment system screen with an audible sound to notify the search is complete.



### WARNING

- While checking for space, if there is a risk of collision with pedestrian, animal or object in the direction of vehicle exit, for your safety, Smart Exit function can be turned off.
- Even if check for space is completed, objects in the blind spot area cannot be detected by the sensors. The driver must directly check the blind spot area and continue using the function.

### **i** Information

Due to abnormal performance of the ultrasonic sensor or the influence of the surroundings, Parking function may not be able to search for an exit space even if there is an exit space, or may search for a space that is not suitable for exiting.

- The parked vehicle has objects attached to the bumper such as bumper guard, trailer hitch, etc.

### 3. Select exit direction

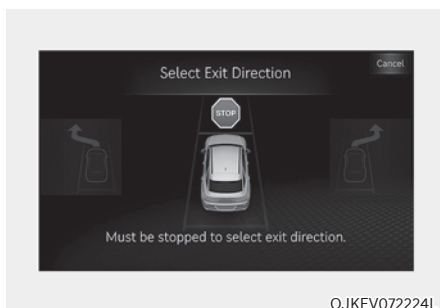

- (1) With the vehicle stopped by depressing the brake pedal, the infotainment system screen displays the possible directions for parallel exit.
- (2) Touch the infotainment system screen or use the central controller to select the desired exit direction.

### **!** CAUTION

- Before selecting the Exit Direction, the driver should check whether the space for exit is suitable.
- If the searched exit space by Remote Smart Parking Assist is narrow or unsuitable (surrounding vehicles are parked vertically, etc.), do not use the Smart Exit function.

### 4. Smart Exit

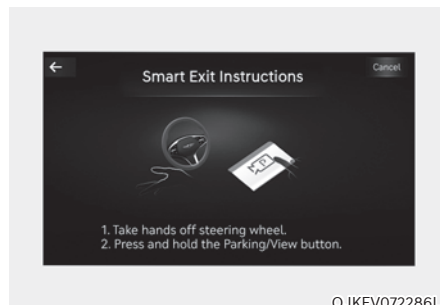

- (1) Press the Parking/View (**P**) button when the vehicle is stopped by depressing the brake pedal. When the brake pedal is released, Remote Smart Parking Assist will automatically control the steering wheel, vehicle speed and gearshift.
- (2) While Smart Exit function is operating, if you do not hold down the Parking/View button, the vehicle will stop and function control will pause. The function will start operating again when the Parking/View button is pressed and held again.
- (3) When the vehicle reaches the target exit location, a message will appear on the infotainment system screen to inform you that exit is complete.

**i Information**

- **Smart Exit function will not operate if the door is open or the seat belt is not fastened.**
- **Vehicle speed can be adjusted by depressing the brake pedal while Smart Exit function is operating. However, the vehicle does not accelerate even when the accelerator pedal is depressed.**
- **If exit is completed while depressing the brake pedal, Smart Exit function will complete with the gear in D (Drive).**
- **If exit is completed while depressing the accelerator pedal, you must take your foot off the accelerator pedal once for the accelerator pedal to operate.**
- **If there is no vehicle operation such as depressing the brake pedal or accelerator pedal within 4 seconds after exit is complete, the vehicle will automatically shift to P (Park) and engage EPB (Electronic Parking Brake).**
- **After Exit function is complete, always check the surroundings before driving.**

**Smart Exit operation status**

Operation status	Turn signal
Under control	The turn signal of the exit direction blinks until the exit is complete or Smart Exit is cancelled.

**How to turn off Smart function while operating**

- Press the Parking/View (P) button in the following stage:
  - Checking space
  - Select exit direction
- Shift the gear to R (Reverse) in the following stage:
  - Checking space
  - Select exit direction
- Press the Parking Safety (P) button or select 'Cancel' on the infotainment system screen to turn off Exit function.
- While Smart Exit function is operating, if the vehicle is stopped by depressing the brake pedal, and the gear is shifted, Exiting function will turn off. At this time, EPB (Electronic Parking Brake) will not be engaged.

**The function will pause in the following conditions when:**

- There is a pedestrian, animal or object in the direction the vehicle is moving
- The door or tailgate is open
- The driver's seat belt is not fastened
- Blind-Spot Collision-Avoidance Assist or Rear-Cross Traffic Collision-Avoidance Assist operates while the vehicle is being controlled in the reverse direction
- The Parking/View (P) button is not continuously pressed
- The vehicle is stopped by depressing the brake pedal

When Exit function is paused, the vehicle will stop. If the condition that made the function to pause disappears, the function may operate again.

The function will cancel in the following conditions when:

- Smart Exit
  - The steering wheel is steered
  - The gear is shifted while the vehicle is moving
  - Operating EPB while the vehicle is moving
  - The hood is open
  - The driver opens the door with the seatbelt unfastened
  - Rapid acceleration occurs
  - Vehicle skid occurs
  - The wheel is stuck by an obstacle and cannot move
  - There are pedestrians, animals or objects at the front and rear of the vehicle at the same time
  - Approximately 3 minutes and 50 seconds have past after Smart Exit function has started to operate
  - The slope of the road exceeds the operational range
  - The function was paused for more than 1 minute
  - The steering wheel, gearshift, braking, and drive controls are not working properly
  - ABS, TCS or ESC system operates due to slippery road conditions
  - The charging door is open

When Smart Exit function is cancelled, the vehicle will automatically stop, shift the gear to P (Park) and engage EPB (Electronic Parking Brake).

## Remote Smart Parking Assist malfunction and limitations

### *Remote Smart Parking Assist malfunction*

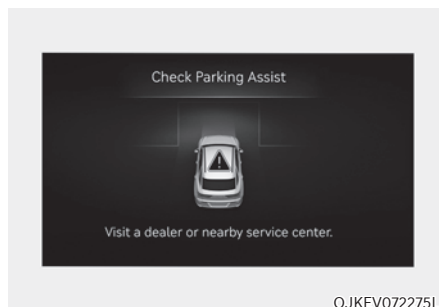

### Remote Smart Parking Assist check

When Remote Smart Parking Assist is not working properly, the 'Check Parking Assist' warning message will appear on the infotainment system screen. If the message appears, stop using Remote Smart Parking Assist, and we recommend that the vehicle be inspected by an authorized retailer of Genesis Branded products.

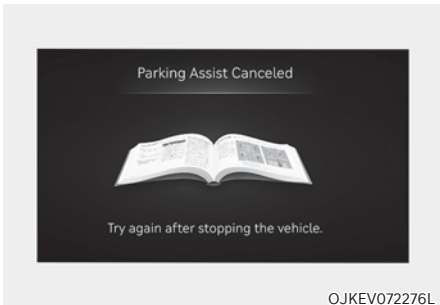

**Remote Smart Parking Assist cancelled**

When Remote Parking Assist is operating, the function can be cancelled, and the 'Parking Assist Canceled' warning message may appear regardless of the parking order. Other messages may appear depending on the situations. Follow the instructions provided on the infotainment system screen while parking your vehicle with Remote Parking Assist. Always look around and pay attention when using Remote Smart Parking Assist.

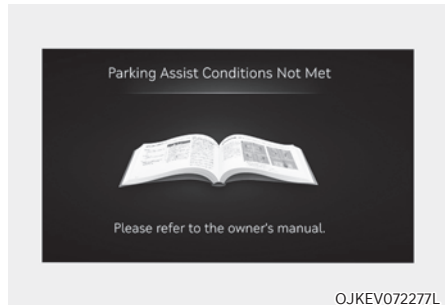

**Remote Smart Parking Assist standby**

'Parking Assist Conditions Not Met' message appears when Parking/View (P) button has been pressed and held while Remote Smart Parking Assist is in standby. After a while, press and hold the Parking/View (P) button again to see if Remote Smart Parking Assist works.

The message appears even when the smart key's battery is low. Check the smart key battery level.

It does not work even when the EV mode is in the Utility mode. For related information refer to Utility Mode in 'Starting your electric vehicle'.

### ***Limitations of Remote Smart Parking Assist***

In the following circumstances, Remote Smart Parking Assist performance to park or exit the vehicle may be limited, there may be a risk of collision, or Remote Smart Parking Assist may turn off. Park or exit the vehicle manually if necessary.

- An object is attached to the steering wheel
- The vehicle is installed with a snow chain, spare tire or different size wheel
- Tire pressure is lower or higher than the standard tire pressure
- Your vehicle is loaded with cargo longer or wider than your vehicle or a trailer is connected to your vehicle
- There is a problem with the wheel alignment
- Your vehicle is leaned severely to one side
- Your vehicle is equipped with a trailer hitch
- The license plate is installed differently from the original location
- There is a person, animal or object above or below the ultrasonic sensor when Remote Smart Parking Assist is activated
- There is an obstacle such as a person, animal or object (trash can, bicycle, motorcycle, shopping cart, narrow pillar, etc.) near the parking space
- There is a circular pillar or narrow pillar, or a pillar surrounded by objects such as fire extinguisher, etc., near the parking space
- The road surface is bumpy (curbstone, speed bump, etc.)
- The road is slippery
- The parking line is too thin or thick
- The parking line is partially erased or blurred
- The parking line is obscured by people, animals, or objects such as snow, boxes, etc.
- There is heavy wind
- Operating Remote Smart Parking Assist on uneven roads, gravel roads, bushes, etc.
- The performance of the ultrasonic sensor is affected by extremely hot or cold weather
- The ultrasonic sensor is covered with snow or water
- An object that generates ultrasonic waves is nearby
- A wireless device with a transmission function operates near the ultrasonic sensors
- Your vehicle is affected by another vehicle's Parking Distance Warning
- The sensor is mounted or positioned incorrectly by an impact to the bumper
- The ultrasonic sensor cannot detect the following objects when:
  - Sharp or slim objects, such as ropes, chains or small poles
  - Objects smaller than 100 cm (40 in.) in length and narrower than 14 cm (6 in.) in diameter
  - Objects which tend to absorb sensor frequency, such as clothes, spongy material or snow
  - A narrow object such as a corner of a square pillar
  - Person, animal or object near the ultrasonic sensor

Remote Smart Parking Assist may not operate properly under the following circumstances:

- Parking on inclines

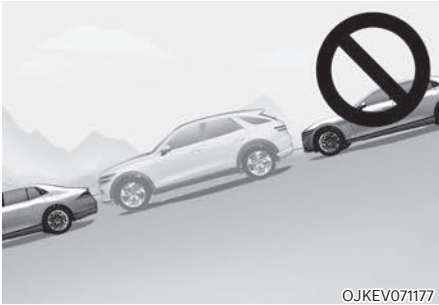

Park manually when parking on inclines.

- Parking in snow



Snow may interfere with sensor operation, or Remote Smart Parking Assist may cancel if the road is slippery while parking.

- Parking on uneven road



Remote Smart Parking Assist may cancel when the vehicle slips, or the vehicle cannot move due to road conditions such as pebbles or fragmented stones.

- Parking behind a truck



Do not use Remote Smart Parking Assist around vehicles with higher ground clearance, such as a bus, truck, etc. It may lead to an accident.



- Parking near a pillar

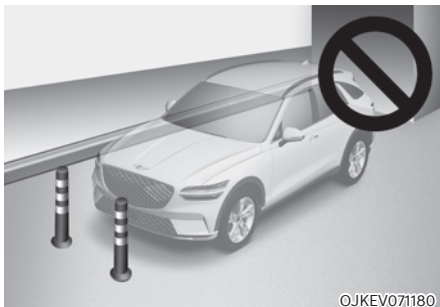

OJKEV071180

Remote Smart Parking Assist performance may reduce or collision with an obstacle may occur when there is a narrow object, circular pillar, square pillar, or a pillar surrounded by objects such as a fire extinguisher, etc., near the parking space. The driver should park the vehicle properly.

- Parking in a parking space with a vehicle on one side only



OJKEV071181

If Remote Smart Parking Assist is used, when parking in a parking space with a vehicle only on one side, your vehicle may cross the parking line to avoid the parked vehicle.

- Parking diagonal

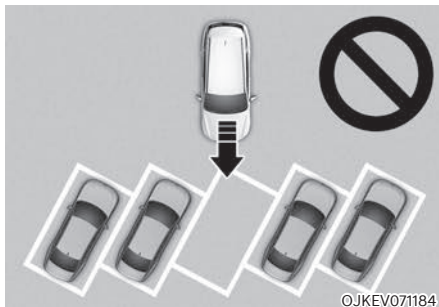

OJKEV071184

Remote Smart Parking Assist does not provide diagonal parking. Even if your vehicle was able to enter the parking space, do not use Remote Smart Parking Assist because the function cannot operate properly.

- Leaving a parking space near a wall or parking in a narrow space



OJKEV071182

- Remote Smart Parking Assist may not operate properly when leaving a parking space that is narrow and near a wall. Always check for pedestrians, animals, objects while leaving.
- For your safety, Remote Smart Parking Assist does not search for parking spaces at areas with narrow parking spaces that are narrower than the minimum space required for parking.



## WARNING

Take the following precautions when using Remote Smart Parking Assist:

- The driver is responsible for safe parking and exit when using Remote Smart Parking Assist.
- When using Remote Smart Parking Assist, stay out of the vehicle's path for your safety
- Always check surroundings when using Remote Smart Parking Assist. You may collide with pedestrians, animals, or objects if they are near the sensor or are in the sensor's blind spot area.
- A collision may occur if a pedestrian, animal, or object suddenly appears while Remote Smart Parking Assist is operating.
- Do not use Remote Smart Parking Assist when under the influence of alcohol.
- Do not let children or other people to use the smart key.
- If Remote Smart Parking Assist is used continuously for a long period, it may adversely affect Remote Smart Parking Assist performance.
- Remote Smart Parking Assist may not operate properly if the vehicle needs wheel alignment adjustment such as when the vehicle tilts to one side. We recommend that the vehicle be inspected by an authorized retailer of Genesis Branded Products.
- Noise may be heard when braking occurs by Remote Smart Parking Assist or when the brake pedal is depressed by the driver.

- Remote Smart Parking Assist may suddenly apply the brake to avoid collision.
- Use Remote Smart Parking Assist only in a parking space that is large enough for the vehicle to move safely.

## NOTICE

- If the 3rd stage warning (continuous beep) of the Forward/Reverse Parking Distance Warning sounds while Remote Smart Parking Assist is operating, it means the obstacle detected is close to your vehicle. At this time, Remote Smart Parking Assist will temporarily stop operating. Make sure there are no pedestrians, animals, or objects around your vehicle.
- Depending on brake operation, the stop lights may come on while the vehicle is moving.
- If the vehicle is remotely started that has been parked in cold weather for a long time, the operation of Remote Smart Parking function may be delayed or cancelled depending on the vehicle condition.

## DECLARATION OF CONFORMITY (IF EQUIPPED)

### Front radar

The radio frequency components (Front Radar) complies:

- For Europe and CE certified countries



Model : LRR-25

Hereby LRR-25 has been so constructed that it can be operated in at least one Member State without infringing applicable requirements of use of radio spectrum. (RED article 10.2)

Hereby, Mando Corp declares that the radio equipment type LRR-25 is in compliance with Directive 2014/53/EU.

The full text of the EU declaration of conformity is available at the following internet address:  
<https://www.mando.com/md/md04.jsp>

OANATEL285

- For Australia



OANATEL287

- For United Arab Emirates



OANATEL288

- For Brazil



OANATEL289

■ For Serbia



■ For Moldova



■ For Ukraine

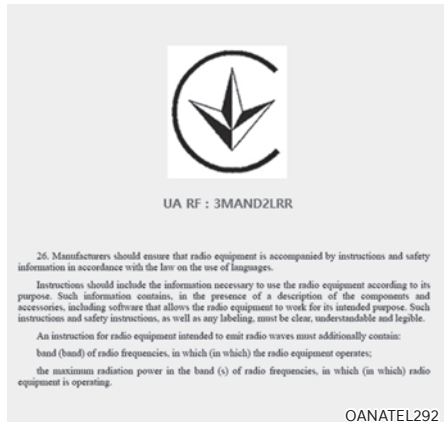

■ For Oman



■ For Israel



■ For Mexico

IFETEL : RCPMALR19-1603

"La operación de este equipo está sujeta a las siguientes dos condiciones:  
 (1) es posible que este equipo o dispositivo no cause interferencia perjudicial y  
 (2) este equipo o dispositivo debe aceptar cualquier interferencia, incluyendo la que pueda causar su operación no deseada."  
 and RCPMALR19-1603

OANATEL295

■ For Singapore

**Complies with  
 IMDA Standards  
 [Dealer's Licence No.]**

Dealer number : DA107248

OANATEL298

■ For Jordan

Model : LRR-25 (Mando)

OANATEL296

■ For Russia

**EAC**

OANATEL299

■ For Malaysia



HIDF16000136

OANATEL297

### Front corner radar/Rear corner radar

The radio frequency components (Front Corner Radar/Rear Corner Radar) complies:

■ For Taiwan



電信法第 48 條、低功率電波輻射性電機管理辦法  
第十二條

經型式認證合格之低功率射頻電機，非經許可，公司、商號或使用者均不得擅自變更頻率、加大功率或變更原設計之特性及功能。

第十四條

低功率射頻電機之使用不得影響飛航安全及干擾合法通信；經發現有干擾現象時，應立即停用，並改善至無干擾時方得繼續使用。

前項合法通信，指依電信法規定作業之無線電通信。低功率射頻電機須忍受合法通信或工業、科學及醫療用電波輻射性電機設備之干擾。

Article 12

Without permission, any company, firm or user shall not alter the frequency, increase the power, or change the characteristics and functions of the original design of the certified lower power frequency electric machinery.

Article 14

The application of low power frequency electric machineries shall not affect the navigation safety nor interface a legal communication, if an interference is found, the service will be suspended until improvement is made and the interference no longer exist.

OANATEL055

■ For Indonesia

59903/SDPPI/2019  
8837

OANATEL056

■ For Malaysia



OANATEL057

■ For Singapore

Complies with  
IMDA Standards  
DA 103787

OANATEL058

■ For Brazil



03981-19-06830

Este equipamento opera em caráter secundário, isto é, não tem direito à proteção contra interferência prejudicial, mesmo de estações do mesmo tipo, e não pode causar interferência a sistemas operando em caráter primário.

OANATEL399

■ For Mexico

IFETEL: RCPAPJ419-0206

"La operación de este equipo está sujeta a las siguientes dos condiciones:

(1) es posible que este equipo o dispositivo no cause interferencia perjudicial y  
(2) este equipo o dispositivo debe aceptar cualquier interferencia, incluyendo la que pueda causar su operación no deseada."

OANATEL059

■ For Ukraine



UA RF: IAPTIV J4TR

справжнім (найменування виробника) заявляє, що тип радіобладнання (позначення типу радіобладнання) в ідповідає Технічному регламенту радіобладнання;

повний текст декларації про відповідність доступний на веб-сайті з такою адресою:  
[www.aptiv.com/automotive-homologation](http://www.aptiv.com/automotive-homologation)

OANATEL060

■ For Jordan

TRC/SS/2019/166

OANATEL062

■ United Arab Emirates

TRA  
REGISTERED No:  
ER70016/19

DEALER No:  
DA0062437/11

OANATEL063

■ Ghana

NCA approved: BR3-1M-GE2-003

OANATEL064

■ Serbia and Montenegro



■ Republic of South Africa



■ For Europe and CE certified countries

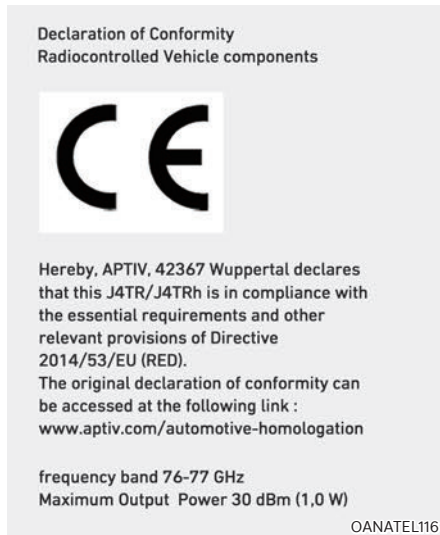

■ For Paraguay





■ For Thailand



เครื่องวิทยุคมนาคมนี้ ได้รับความเห็น ไม่ต้องได้รับใบอนุญาตให้มี ใช้ซึ่งเครื่องวิทยุคมนาคม หรือตั้งสถานีวิทยุคมนาคมตามประกาศ กสทช. เรื่อง เครื่องวิทยุคมนาคม และสถานีวิทยุคมนาคมที่ได้รับความเห็นไม่ต้องได้รับใบอนุญาตวิทยุคมนาคมตามพระราชบัญญัติวิทยุคมนาคม พ.ศ. 2498

**nans.** โทรคมนาคม  
กำกับดูแลเพื่อประชาชน  
Call Center 1200 (InswS)

OANATEL320

■ For Israel

14. התנאים כיוצא בזה:

א. המכשיר יישמש רק לצורכי אישיים. המכשיר אינו מיועד לשימוש מסחרי או צבאי.

ב. אין להשתמש במכשיר לצורך הפעלת אמצעי תקשורת אחרים או לצורך הפעלת אמצעי תקשורת אחרים.

ג. אסור להחליף את האנטנה המקורית של המכשיר, ולא לעשות בו כל שינוי טכני אחר.

חוק מספר: 63-66570:

א. יש להשתמש במכשיר זה על בסיס "משטר" מסוים לפי הפעלה אלקטרונית.

ב. אין להשתמש במכשיר זה לצורך הפעלת אמצעי תקשורת אחרים או לצורך הפעלת אמצעי תקשורת אחרים.

ג. אסור להחליף את האנטנה המקורית של המכשיר, ולא לעשות בו כל שינוי טכני אחר.

ד. האישור הנתון אינו עולה על "output power of the device" הפועל "operating frequencies of the device".

OANATEL400

■ For Morocco

AGREE PAR L'ANRT MAROC  
Numéro d'agrément : MR 18361 ANRT 2018  
Date d'agrément : 24/12/2018

OANATEL401

■ For Australia



OANATEL327

■ For United Kingdom



Hereby, APTIV, 42367 Wuppertal declares that this H5TR is in compliance with the essential requirements and other relevant provisions of Directive Radio Equipment Regulations 2017.

frequency band 76-77 GHz  
Maximum Output Power 30 dBm (1,0 W)

OANATEL362

# 8. Emergency situations

Hazard warning flasher.....	8-2
In case of an emergency while driving.....	8-2
If the vehicle stalls while driving.....	8-2
If the vehicle stalls at a crossroad or crossing .....	8-2
If you have a flat tire while driving .....	8-3
If the vehicle will not start.....	8-3
Confirm the EV battery is not low on the charge gauge .....	8-3
Jump starting (12 V battery).....	8-4
Tire Pressure Monitoring System (TPMS).....	8-8
Check tire pressure .....	8-8
Tire pressure monitoring system.....	8-9
Low tire pressure warning light.....	8-10
Low tire pressure position and tire pressure telltale.....	8-10
TPMS (Tire Pressure Monitoring System) malfunction indicator .....	8-11
Changing a tire with TPMS .....	8-11
If you have a flat tire (with Tire Mobility Kit) .....	8-13
Introduction.....	8-13
Notes on the safe use of the Tire Mobility Kit .....	8-14
Components of the Tire Mobility Kit.....	8-15
Using the Tire Mobility Kit When a tire is flat .....	8-16
How to adjust tire pressure .....	8-19
Towing .....	8-21
Towing service.....	8-21
Removable towing hook.....	8-22
Emergency commodity .....	8-23
Fire extinguisher.....	8-23
First aid kit .....	8-23
Triangle reflector .....	8-23
Tire pressure gauge.....	8-23
Pan-European eCall System.....	8-25
Information on data processing.....	8-27
Pan-European eCall System .....	8-28

## HAZARD WARNING FLASHER

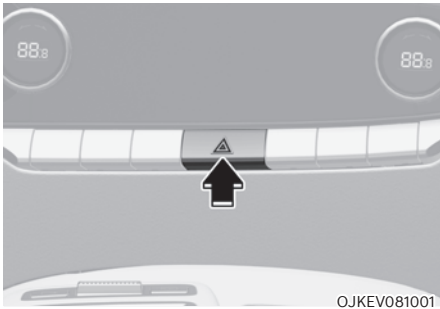

The hazard warning flasher serves as a warning to other drivers to exercise extreme caution when approaching, overtaking, or passing your vehicle.

It should be used whenever emergency repairs are being made or when the vehicle is stopped near the edge of a roadway.

To turn the hazard warning flasher on or off, press the hazard warning flasher button with the Start/Stop button in any position. The hazard warning flasher button is located in the center fascia panel. All turn signal lights will flash simultaneously.

- The hazard warning flasher operates regardless of whether your vehicle is running or not.
- The turn signals do not work when the hazard flasher is on.

## IN CASE OF AN EMERGENCY WHILE DRIVING

### If the vehicle stalls while driving

- Reduce your speed gradually, keeping a straight line. Move cautiously off the road to a safe place.
- Turn on your hazard warning flasher.
- Try to start the vehicle again. If your vehicle will not start, we recommend that you contact an authorized retailer of Genesis Branded products or seek other qualified assistance.

### If the vehicle stalls at a crossroad or crossing

If the vehicle stalls at a crossroads or crossing, if safe to do so, shift the gear to N (Neutral) and then push the vehicle to a safe location.

To stay N (Neutral) while the vehicle is off, refer to 'To stay in N (Neutral) when vehicle is OFF' in chapter 6.

## If you have a flat tire while driving

If a tire goes flat while you are driving:

- Take your foot off the accelerator pedal and let the vehicle slow down while driving straight ahead. Do not apply the brakes immediately or attempt to pull off the road as this may cause loss of vehicle control resulting in an accident. When the vehicle has slowed to such a speed that it is safe to do so, brake carefully and pull off the road. Drive off the road as far as possible and park on firm, level ground. If you are on a divided highway, do not park in the median area between the two traffic lanes.
- When the vehicle is stopped, press the hazard warning flasher button, shift the gear to P (Park), apply the regenerative brake, and press the Start/Stop button to the OFF position.
- Have all passengers get out of the vehicle. Be sure they all get out on the side of the vehicle that is away from traffic.
- When changing a flat tire, follow the instructions provided later in this chapter.

## IF THE VEHICLE WILL NOT START

### Confirm the EV battery is not low on the charge gauge

- Be sure the gear is in P (Park). The vehicle starts only when the gear is in P (Park).
- Check the 12-volt battery connections to be sure they are clean and tight.
- Turn on the interior light. If the light dims or goes out when you operate the starter, the 12 V battery is drained.

Do not push or pull the vehicle to start it. This could cause damage to your vehicle.

See instructions for “Jump Starting” provided in this chapter.

## JUMP STARTING (12 V BATTERY)

Jump starting can be dangerous if done incorrectly. Follow the jump starting procedure in this section to avoid serious injury or damage to your vehicle. If in doubt about how to properly jump start your vehicle, we strongly recommend that you have a service technician or towing service do it for you.



### WARNING

To prevent **SERIOUS INJURY** or **DEATH** to you or bystanders, always follow these precautions when working near or handling the battery:



Always read and follow instructions carefully when handling a battery.



Wear eye protection designed to protect the eyes from acid splashes.



Keep all flames, sparks, or smoking materials away from the battery.



Hydrogen is always present in battery cells, is highly combustible, and may explode if ignited.



Keep batteries out of reach of children.



Batteries contain sulfuric acid which is highly corrosive. Do not allow acid to contact your eyes, skin or clothing.

If acid gets into your eyes, flush your eyes with clean water for at least 15 minutes and get immediate medical attention. If acid gets on your skin, thoroughly wash the area. If you feel pain or a burning sensation, get medical attention immediately.

- When lifting a plastic-cased battery, excessive pressure on the case may cause battery acid to leak. Lift with a battery carrier or with your hands on opposite corners.
- Do not attempt to jump start your vehicle if your battery is frozen.
- NEVER attempt to recharge the battery when the vehicle's battery cables are connected to the battery.
- The electrical ignition system works with high voltage.  
NEVER touch these components with the vehicle running or when the Start/Stop button is in the ON position.
- The electrical ignition system works with high voltage. NEVER touch these components with the (READY) indicator ON or when the START/STOP button is in the ON position.
- Do not allow the (+) and (-) jumper cables to touch. It may cause sparks.
- The battery may rupture or explode when you jump start with a low or frozen battery.
- Do not directly connect the (-) to the jump cable. Connect the (-) to the one of the metallic parts located far from the jump cable in the vehicle. The direct (-) connection to the jump cable may cause an explosion.
- Be sure to use only 12V battery to jump start. Using batteries with other voltages to jump start can damage the battery or even provoke an explosion.

### **WARNING**

- Keep sparks away from the battery as the explosive gas is generated by the sparks while the battery is running.
- When connecting the supplementary battery and the discharged battery with a jump cable because the jump start does not operate with jump start terminal in the motor compartment, do not directly connect the (-) to the jump cable. Connect the (-) to the one of the metallic parts located far from the jump cable in the vehicle. The direct (-) connection to the jumpcable may cause an explosion.
- The battery contains dilute sulfuric acid, which is highly corrosive, so be careful not to let the battery liquid get on your body, clothes, or car body. If dilute sulfuric acid gets on your body or eyes, immediately rinse the area with clean water for about 15 minutes and then consult a doctor.

### *Jump starting procedure*

1. Position the vehicles close enough that the jumper cables will reach, but do not allow the vehicles to touch.
2. Avoid fans or any moving parts in the motor compartment at all times, even when the vehicles are turned off.
3. Turn off all electrical devices such as radios, lights, air conditioning, etc. Put the vehicles in P (Park) and set the parking brake. Turn both vehicles OFF.
4. Open the hood.

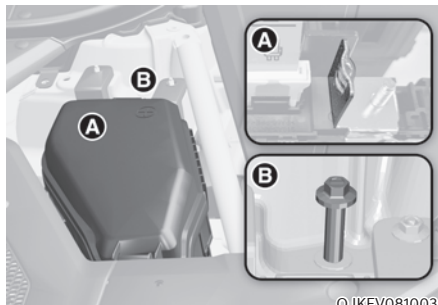

5. Remove the motor compartment fuse box cover.

### **CAUTION**

Before jump starting, make sure to correctly identify the positive (+) and negative (-) terminals to avoid reverse polarity connections.

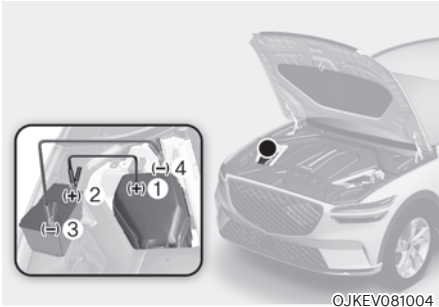

6. Connect the jumper cables in the exact sequence shown in the illustration. First connect one jumper cable to the red, positive (+) jumper terminal of your vehicle (1).
7. Connect the other end of the jumper cable to the red, positive (+) battery/ jumper terminal of the assisting vehicle (2).
8. Connect the second jumper cable to the black, negative (-) battery/ jumper terminal of the assisting vehicle (3).
9. Connect the other end of the second jumper cable to the black, negative (-) chassis ground of your vehicle (4).

Do not allow the jumper cables to contact anything except the correct battery or jumper terminals or the correct ground. Do not lean over the battery when making connections.

 **WARNING**

**Do not connect the jumper cable to the negative (-) jumper terminal of the discharged battery. A spark could cause the battery to explode and lead to a personal injury or vehicle damage.**

10. Start the assisting vehicle and let it run at approximately for a few minutes. Then start your vehicle.
11. Keep your vehicle operating for at least 30 minutes at idle or driving to assure your battery receives enough charge to be able to start on its own after the vehicle is shut off. A completely discharged battery may require as long as 60 minutes runtime to fully recharge it. If the vehicle is run for less, the vehicle may not restart.

If your vehicle will not start after a few attempts, it probably requires service. In this event please seek qualified assistance. If the cause of your battery discharging is not apparent, we recommend that you have your vehicle checked by an authorized retailer of Genesis Branded products.

Disconnect the jumper cables in the exact reverse order you connected them:

1. Disconnect the jumper cable from the black, negative (-) chassis ground of your vehicle (4).
2. Disconnect the other end of the jumper cable from the black, negative (-) battery/chassis ground of the assisting vehicle (3).
3. Disconnect the second jumper cable from the red, positive (+) battery/jumper terminal of the assisting vehicle (2).
4. Disconnect the other end of the jumper cable from the red, positive (+) jumper terminal of your vehicle (1).



### Information



**An inappropriately disposed battery can be harmful to the environment and human health. Dispose of the battery according to your local law(s) or regulations.**

### NOTICE

**To prevent damage to your vehicle:**

- **Only use a 12-volt power supply (battery or jumper system) to jump start your vehicle.**
- **Do not attempt to jump start your vehicle by push-starting.**
- **Always be sure that the battery cover and cable are tightened after finishing jump start your vehicle. Otherwise it may cause damage to the relevant parts, noise trouble, or entrance of foreign substances.**



### WARNING

**While jump starting your vehicle, avoid the positive (+) and negative (-) cables to come in contact. A spark could cause personal injury.**



## TIRE PRESSURE MONITORING SYSTEM (TPMS)



- (1) Low Tire Pressure Telltale/TPMS Malfunction Indicator
- (2) Low Tire Pressure Position Telltale and Tire Pressure Telltale (Shown on the LCD display)

### Check tire pressure



- You can check the tire pressure in the Utility view on the cluster. Refer to the “View Modes” section in chapter 4.
- Tire pressure is displayed after a few minutes of driving after initial vehicle start up.
- If tire pressure is not displayed when the vehicle is stopped, ‘Drive to display’ message will appear. After driving, check the tire pressure.
- The displayed tire pressure values may differ from those measured with a tire pressure gauge.
- You can change the tire pressure unit from the Settings menu in the infotainment system screen. Select:
  - Setup → General Settings → Unit → Tire Air Pressure Unit → psi/kPa/bar

For detailed information, scan the QR code in a separately supplied simple manual.

## Tire pressure monitoring system



### WARNING

**Over-inflation or under-inflation can reduce tire life, adversely affect vehicle handling, and lead to sudden tire failure that may cause loss of vehicle control resulting in an accident.**

Each tire, including the spare (if provided), should be checked monthly when cold and inflated to the inflation pressure recommended by the vehicle manufacturer on the vehicle placard or tire inflation pressure label. (If your vehicle has tires of a different size than the size indicated on the vehicle placard or tire inflation pressure label, you should determine the proper tire inflation pressure for those tires.)

As an added safety feature, your vehicle has been equipped with a tire pressure monitoring system (TPMS) that illuminates a low tire pressure telltale when one or more of your tires is significantly under-inflated. Accordingly, when the low tire pressure telltale illuminates, you should stop and check your tires as soon as possible, and inflate them to the proper pressure. Driving on a significantly under-inflated tire causes the tire to overheat and can lead to tire failure.

Under-inflation also reduces fuel efficiency and tire tread life, and may affect the vehicle's handling and stopping ability.

Please note that the TPMS is not a substitute for proper tire maintenance, and it is the driver's responsibility to maintain correct tire pressure, even if under-inflation has not reached the level to trigger illumination of the TPMS low tire pressure telltale.

Your vehicle has also been equipped with a TPMS malfunction indicator to indicate when the system is not operating properly. The TPMS malfunction indicator is combined with the low tire pressure telltale. When the system detects a malfunction, the telltale will flash for approximately one minute and then remain continuously illuminated. This sequence will continue upon subsequent vehicle start-ups as long as the malfunction exists.

When the malfunction indicator is illuminated, the system may not be able to detect or signal low tire pressure as intended. TPMS malfunctions may occur for a variety of reasons, including the installation of replacement or alternate tires or wheels on the vehicle that prevent the TPMS from functioning properly.

Always check the TPMS malfunction telltale after replacing one or more tires or wheels on your vehicle to ensure that the replacement or alternate tires and wheels allow the TPMS to continue to function properly.

### NOTICE

**If any of the below happens, we recommend that you have the system checked by an authorized retailer of Genesis Branded products.**

- 1. The Low Tire Pressure Telltale/TPMS Malfunction Indicator does not illuminate for 3 seconds when the Start/Stop button is pressed to the ON position or when the vehicle is running.**
- 2. The TPMS Malfunction Indicator remains illuminated after blinking for approximately 1 minute.**
- 3. The Low Tire Pressure Position Telltale remains illuminated.**



## Low tire pressure warning light

### Low tire pressure position and tire pressure telltale



When the tire pressure monitoring system warning indicators are illuminated and a warning message displayed on the cluster LCD display, one or more of your tires is significantly under-inflated. The Low Tire Pressure Position Telltale will indicate which tire is significantly underinflated by illuminating the corresponding position light.

If either telltale illuminates, immediately reduce your speed, avoid hard cornering and anticipate increased stopping distances. You should stop and check your tires as soon as possible. Inflate the tires to the proper pressure as indicated on the vehicle's placard or tire inflation pressure label located on the driver's side center pillar outer panel.

If you cannot reach a service station or if the tire cannot hold the newly added air, replace the low pressure tire with the spare tire (if equipped).

The Low Tire Pressure Telltale will remain on and the TPMS Malfunction Indicator may blink for one minute and then remain illuminated (when the vehicle is driven approximately 10 minutes at speed above 25 km/h (15.5 mph)) until you have the low pressure tire repaired and replaced on the vehicle.



### CAUTION

**In winter or cold weather, the Low Tire Pressure Telltale may be illuminated if the tire pressure was adjusted to the recommended tire inflation pressure in warm weather. It does not mean your TPMS is malfunctioning because the decreased temperature leads to a proportional lowering of tire pressure.**

**When you drive your vehicle from a warm area to a cold area or from a cold area to a warm area, or the outside temperature is greatly higher or lower, you should check the tire inflation pressure and adjust the tires to the recommended tire inflation pressure.**



### WARNING

**Low pressure damage**

**Significantly low tire pressure makes the vehicle unstable and can contribute to loss of vehicle control and increased braking distances.**

**Continued driving on low pressure tires can cause the tires to overheat and fail.**



## TPMS (Tire Pressure Monitoring System) malfunction indicator

The TPMS Malfunction Indicator will illuminate after it blinks for approximately one minute when there is a problem with the Tire Pressure Monitoring System.

We recommend that the system be checked by an authorized retailer of Genesis Branded products as soon as possible.

### **NOTICE**

If there is a malfunction with the TPMS, the Low Tire Pressure Position Telltale will not be displayed even though the vehicle has an under-inflated tire.

### **NOTICE**

The TPMS Malfunction Indicator may illuminate after blinking for one minute if the vehicle is near electric power supply cables or radio transmitters such as police stations, government and public offices, broadcasting stations, military installations, airports, transmitting towers, etc.

Additionally, the TPMS Malfunction Indicator may illuminate if snow chains are used or electronic devices such as computers, chargers, remote starters, navigation, etc. This may interfere with normal operation of the TPMS.

## Changing a tire with TPMS

If you have a flat tire, the Low Tire Pressure and Position telltales will come on. We recommend that the flat tire be repaired by an authorized retailer of Genesis Branded products as soon as possible or replace the flat tire with the spare tire (if equipped).

### **NOTICE**

**It is recommended that you do not use a puncture-repairing agent not approved by an authorized retailer of Genesis Branded products or the equivalent specified for your vehicle to repair and/or inflate a low pressure tire. Tire sealant not approved by an authorized retailer of Genesis Branded products or the equivalent specified for your vehicle may damage the tire pressure sensor.**

The spare tire (if equipped) does not come with a tire pressure monitoring sensor. When the low pressure tire or the flat tire is replaced with the spare tire, the Low Tire Pressure Telltale will remain on. Also, the TPMS Malfunction Indicator will illuminate after blinking for one minute if the vehicle is driven at speed above 25 km/h (15.5 mph) for approximately 10 minutes.

Once the original wheel equipped with a tire pressure monitoring sensor is reinflated to the recommended pressure and reinstalled on the vehicle, the Low Tire Pressure Telltale and TPMS Malfunction Indicator will go off within a few minutes of driving.

If the indicators do not extinguish after a few minutes we recommend to consult an authorized retailer of Genesis Branded products.

Each wheel is equipped with a tire pressure sensor mounted inside the tire behind the valve stem (except for the spare tire). You must use TPMS specific wheels. It is recommended that you always have your tires serviced by an authorized retailer of Genesis Branded products.

You may not be able to identify a tire with low pressure by simply looking at it. Always use a good quality tire pressure gauge to measure. Please note that a tire that is hot (from being driven) will have a higher pressure measurement than a tire that is cold.

A cold tire means the vehicle has been sitting for 3 hours and driven for less than 1.6 km (1 mile) in that 3 hour period.

Allow the tire to cool before measuring the inflation pressure. Always be sure the tire is cold before inflating to the recommended pressure.



### **WARNING**

- **The TPMS cannot alert you to severe and sudden tire damage caused by external factors such as nails or road debris.**
- **If you feel any vehicle instability, immediately take your foot off the accelerator, apply the brakes gradually with light force, and slowly move to a safe position off the road.**



### **WARNING**

**Tampering with, modifying, or disabling the Tire Pressure Monitoring System (TPMS) components may interfere with the system's ability to warn the driver of low tire pressure conditions and/or TPMS malfunctions. Tampering with, modifying, or disabling the Tire Pressure Monitoring System (TPMS) components may void the warranty for that portion of the vehicle.**



### **WARNING**

**For Europe**

- **Do not modify the vehicle; it may interfere with the TPMS function.**
- **The wheels on the market do not have a TPMS sensor.**

**For your safety, we recommend that you use parts for replacement from an authorized retailer of Genesis Branded products.**

- **If you use the wheels on the market, we recommend that you use a TPMS sensor approved by an authorized retailer of Genesis Branded products or the equivalent approved for your vehicle. If your vehicle is not equipped with a TPMS sensor or TPMS does not work properly, you may fail the periodic vehicle inspection conducted in your country.**

## IF YOU HAVE A FLAT TIRE (WITH TIRE MOBILITY KIT)



For safe operation, carefully read and follow the instructions in this manual before use.

- (1) Compressor
- (2) Sealant bottle

The tire mobility kit is a temporary fix to the tire we recommend the tire be inspected by an authorized retailer of Genesis Branded products or the equivalent approved for your vehicle as soon as possible.

### CAUTION

**When two or more tires are flat, do not use the tire mobility kit because the sealant provided with the Tire Mobility Kit must be used for only one flat tire.**

### WARNING

**Do not use the Tire Mobility Kit to repair punctures in the tire walls. This can result in an accident due to tire failure.**

### WARNING

**Have your tire repaired as soon as possible. The tire may lose air pressure at any time after inflating with the Tire Mobility Kit.**

## Introduction

With the Tire Mobility Kit you stay mobile even after experiencing a tire puncture.

The compressor and sealing compound system effectively and comfortably seals most punctures in a passenger car tire caused by nails or similar objects and reinflates the tire.

After you ensure that the tire is properly sealed you can drive cautiously on the tire (distance up to 200 km (120 miles)) at a max. speed of 80 km/h (50 mph) in order to reach a service station or tire dealer for the tire replacement.

It is possible that some tires, especially with larger punctures or damage to the sidewall, cannot be sealed completely.

Air pressure loss in the tire may adversely affect tire performance.

For this reason, you should avoid abrupt steering or other driving maneuvers, especially if the vehicle is heavily loaded or if a trailer is in use.

The Tire Mobility Kit is not designed or intended as a permanent tire repair method and is to be used for one tire only.

This instruction shows you step by step how to temporarily seal the puncture simply and reliably.

Read the section “Notes on the safe use of the Tire Mobility Kit”.



## **WARNING**

**Do not use the TMK if a tire is severely damaged by driving run flat or with insufficient air pressure.**

**Only punctured areas located within the tread region of the tire can be sealed using the TMK.**

### **Notes on the safe use of the Tire Mobility Kit**

- Park your car at the side of the road so that you can work with the Tire Mobility Kit away from moving traffic.
- To be sure your vehicle will not move, even when you're on fairly level ground, always set your parking brake.
- Only use the Tire Mobility Kit for sealing/inflation passenger car tires. Only punctured areas located within the tread region of the tire can be sealed using the tire mobility kit.
- Do not use on motorcycles, bicycles or any other type of tires.
- When the tire and wheel are damaged, do not use Tire Mobility Kit for your safety.
- Use of the Tire Mobility Kit may not be effective for tire damage larger than approximately 4 mm (0.16 in).

We recommend to contact the nearest authorized retailer of Genesis Branded products if the tire cannot be made roadworthy with the tire mobility kit.

- Do not use the Tire Mobility Kit if a tire is severely damaged by driving run flat or with insufficient air pressure.
- Do not remove any foreign objects such as nails or screws that have penetrated the tire.
- Provided the car is outdoors, leave the vehicle running. Otherwise operating the compressor may eventually drain the car battery.
- Never leave the Tire Mobility Kit unattended while it is being used.
- Do not leave the compressor running for more than 10 minutes at a time or it may overheat.
- Do not use the Tire Mobility Kit if the ambient temperature is below -30°C (-22°F).
- In case of skin contact with the sealant, wash the area thoroughly with plenty of water. If the irritation persists, seek medical attention.
- In case of eye contact with the sealant, flush your eyes for at least 15 minutes. If the irritation persists, seek medical attention.
- In case of swallowing the sealant, rinse the mouth and drink plenty of water. However, never give anything to an unconscious person and seek medical attention immediately.
- Long time exposure to the sealant may cause damage to bodily tissue such as kidney, etc.

## Components of the Tire Mobility Kit

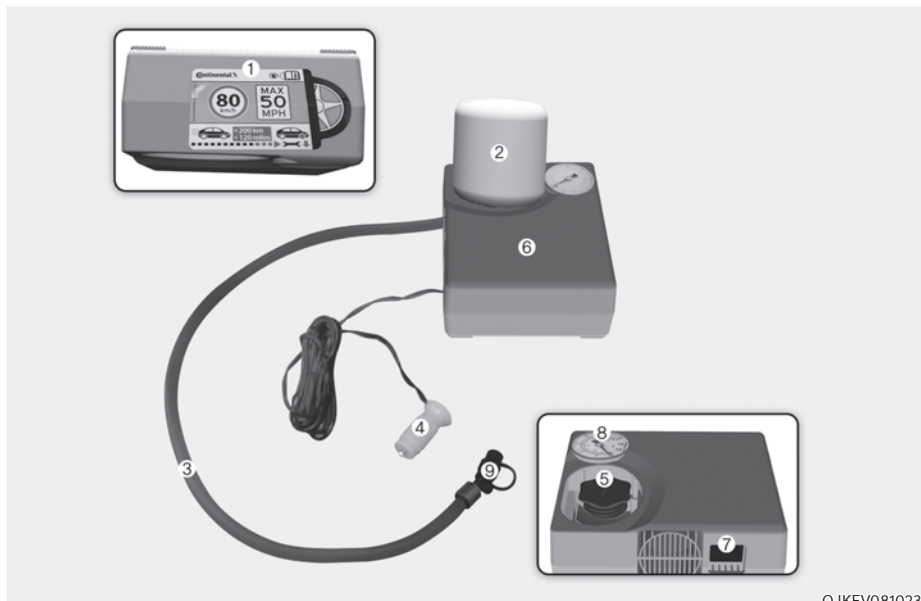

OJKEV081023

- |   |   |
|---|---|
| <ol style="list-style-type: none"> <li>1. Speed restriction label</li> <li>2. Sealant bottle and label with speed restriction</li> <li>3. Filling hose from sealant bottle to wheel</li> <li>4. Connectors and cable for power outlet direct connection</li> <li>5. Holder for the sealant bottle</li> <li>6. Compressor</li> </ol> | <ol style="list-style-type: none"> <li>7. ON/OFF switch</li> <li>8. Pressure gauge for displaying the tire inflation pressure</li> <li>9. Button for reducing the tire inflation pressure</li> </ol> <p>Strictly follow the specified sequence, otherwise the sealant may escape under high pressure.</p> |
|---|---|



### **WARNING**

#### **Expired sealant**

**Do not use the Tire sealant after the sealant has expired (for example, pasted the expiration date on the sealant container). This can increase the risk of tire failure.**



 **WARNING**

**Sealant**

- Keep out of reach of children.
- Avoid contact with eyes.
- Do not swallow.

**Using the Tire Mobility Kit When a tire is flat**

 **CAUTION**

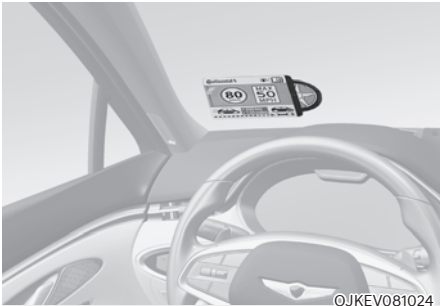

**Detach the speed restriction label from the sealant bottle (2), and place it in a highly visible place inside the vehicle to remind the driver not to drive too fast.**

 **CAUTION**

**If only the tire pressure needs to be adjusted, refer to “How to Adjust Tire Pressure” in this chapter.**

**Before using the Tire Mobility Kit, be fully aware of the explanation on the sealant.**

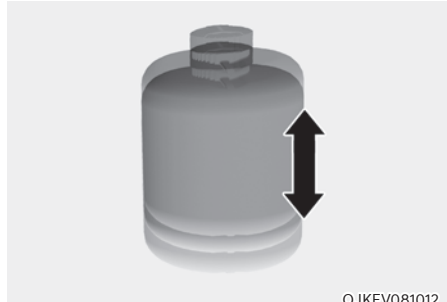

1. Shake the sealant bottle (2).

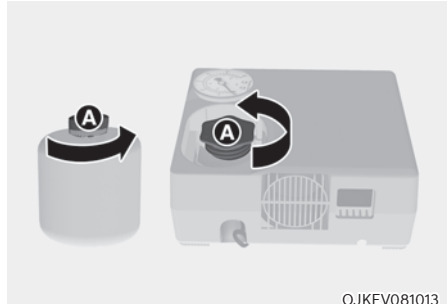

2. Remove the cover (A) of the sealant bottle (2) and compressor (6).



OTM080024

3. Connect the sealant bottle (2) and compressor (6).
4. Make sure that the valve (9) for reducing tire inflation pressure is closed.

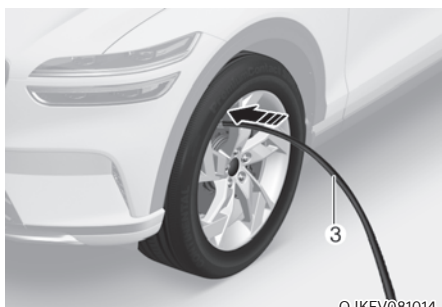

OJKEV081014

5. Unscrew the valve cap from the valve of the defective wheel and screw the filling hose (3) of the sealant bottle onto the valve.

### CAUTION

Securely install the sealant filling hose to the valve. If not, sealant may flow backward, possibly clogging the filling hose.

6. Make sure the compressor turns off by pressing [O] of the main switch (7).



OJKEV081015

7. Plug the compressor power cord (4) into the vehicle power outlet.
8. With the vehicle ON (READY indicator ON), switch on the compressor and let it run for approximately 5~7 minutes to fill the sealant up to proper pressure. (refer to the Tire and Wheels, chapter 2). The inflation pressure of the tire after filling is unimportant and will be checked/corrected later.

Be careful not to overinflate the tire and stay away from the tire when filling it.

 **CAUTION**

**Tire pressure**

**Do not attempt to drive your vehicle if the tire pressure is below 200 kPa (29 psi). This could result in an accident due to sudden tire failure.**

9. Switch off the compressor.
10. Detach the hoses from the sealant bottle connector and from the tire valve.

Return the Tire Mobility Kit to its storage location in the vehicle.

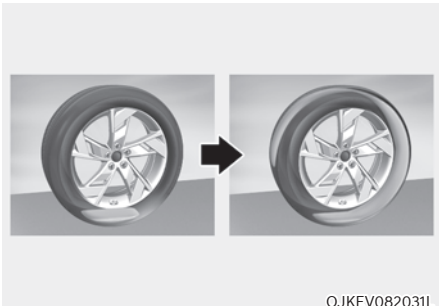

11. Immediately drive approximately 7~10 km (4~6 miles or, about 10min) to evenly distribute the sealant in the tire.

Do not exceed a speed of 80 km/h (50 mph). If possible, do not fall below a speed of 20 km/h (12 mph).

While driving, if you experience any unusual vibration, ride disturbance or noise, reduce your speed and drive with caution until you can safely pull off of the side of the road.

Call for road side service or towing.

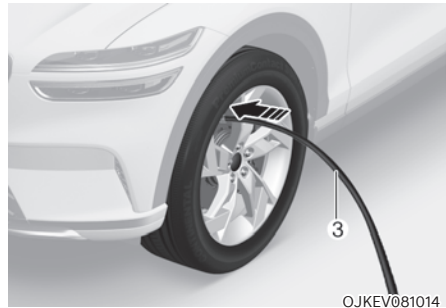

12. After driving approximately 7~10 km (4~6 miles or about 10 min), stop at a safety location.
13. Connect the filling hose (3) of the compressor directly to the tire valve.
14. Connect cables (4) to the battery.
15. Adjust the tire inflation pressure to the recommended tire inflation.

With the Vehicle is ON (READY indicator ON) proceed as follows.

- To increase the inflation pressure : Switch on the compressor. To check the current inflation pressure setting, briefly switch off the compressor.
- To reduce the inflation pressure: Adjust the valve (9) for reducing tire inflation pressure.

**NOTICE**

Do not let the compressor run for more than 10 minutes, otherwise the device will overheat and may be damaged.

**i Information**

The pressure gauge may show higher than actual reading when the compressor is running. To get an accurate tire pressure, the compressor needs to be turned off.

**⚠ CAUTION**

If the inflation pressure is not maintained, drive the vehicle a second time, refer to step 11.

Then repeat steps 12 to 15.

Use of the TMK may be ineffectual for tire damage larger than approximately 4 mm (0.16 in).

We recommend that you contact an authorized retailer of Genesis Branded products if the tire cannot be made roadworthy with the Tire Mobility Kit.

**⚠ WARNING**

The tire inflation pressure must be inflated to the proper pressure (Refer to “Tire and Wheels” section in chapter 2). If it is not, do not continue driving. Call for road side service or towing.

**⚠ CAUTION**

**Tire pressure sensor**

The sealant on the tire pressure sensor and wheel should be removed when you replace the tire with a new one and inspect the tire pressure sensors. We recommend that you get this done at an authorized retailer of Genesis Branded products.

**i Information**

When reinstalling the repaired or replaced tire and wheel on the vehicle, tighten the wheel bolt to 14~16 kgf·m (101~116 lbf·ft).

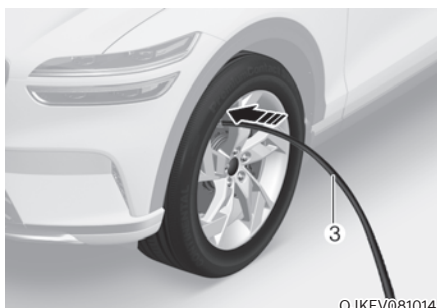
**How to adjust tire pressure**

1. Park your vehicle in a safe location.
2. Connect the filling hose (3) of the compressor directly to the tire valve.
3. Connect cables (4) to the battery.

4. Adjust the tire inflation pressure to the recommended tire inflation.

With the Vehicle is ON (READY indicator ON), proceed as follows.

- To increase the inflation pressure : Switch on the compressor. To check the current inflation pressure setting, briefly switch off the compressor.
- To reduce the inflation pressure: Adjust the valve (9) for reducing tire inflation pressure.

**NOTICE**

**Do not let the compressor run for more than 10 minutes, otherwise the device will overheat and may be damaged.**

 **Information**

- **The pressure gauge may show higher than actual reading when the compressor is running. To get an accurate tire reading, the compressor needs to be turned off.**
- **When reinstalling the repaired or replaced tire and wheel on the vehicle, tighten the wheel bolt to 14~16 kgf·m (101~116 lbf·ft).**

 **CAUTION**

**Do not use the sealant when the tire pressure only needs to be adjusted.**

 **WARNING**

**The tire inflation pressure must be inflated to the proper pressure (Refer to “Tire and Wheels” section in chapter 2). If it is not, do not continue driving. Call for road side service or towing.**

## TOWING

### Towing service

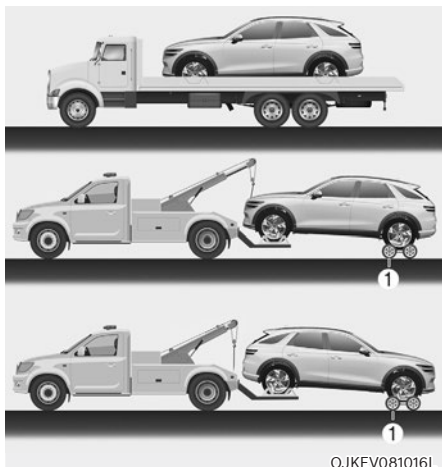

[1]: Dollies

If emergency towing is necessary, we recommend having it done by an authorized retailer of Genesis Branded products or a commercial tow-truck service.

Proper lifting and towing procedures are necessary to prevent damage to the vehicle. The use of wheel dollies or flatbed is recommended.

For AWD vehicles, it must be towed with a wheel lift and dollies or flatbed equipment with all the wheels off the ground.

### *Precautions when moving a short distance before towing a vehicle*

Move short distances within 10 m at a speed of 5 km/h or less only when loading on a tow truck or if the vehicle needs to be repositioned. At this time, the gear must be in the 'N' (neutral) position and the parking brake must be released. If it is impossible to operate the reduction gear and parking brake, move the vehicle with all wheel lifted.

### **NOTICE**

**Do not lift the vehicle by the tow fitting or body and chassis parts. Otherwise the vehicle may be damaged.**

**⚠ CAUTION**

- Do not tow the vehicle with any wheels on the ground as this may cause damage to the vehicle.



- Do not tow with sling-type equipment. Use wheel lift or flatbed equipment.



**⚠ CAUTION**

Failure to shift the gear to 'N' (neutral) may cause internal damage to the reduction gear.

### Removable towing hook

We recommend that your vehicle be towed by an authorized retailer of Genesis Branded products or a commercial tow-truck service. Only use the tow hook to move short distances or to lift the vehicle before towing.

1. Open the tailgate, and remove the towing hook from the tool case.

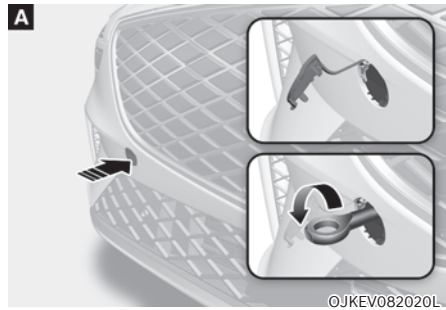

[A]: Front, [B]: Rear

2. Remove the hole cover by pressing the lower part of the cover on the bumper.
3. Install the towing hook by turning it clockwise into the hole until it is fully secured.
4. Remove the towing hook and install the cover after use.

## EMERGENCY COMMODITY (IF EQUIPPED)

Your vehicle is equipped with emergency commodities to help you respond to emergency situation.

### Fire extinguisher

#### NOTICE

**This vehicle is equipped with the powder-type fire extinguisher exclusively for the fire caused by the electricity in the vehicle. Using water or other inappropriate fire extinguisher may cause the electric shock and collateral damage. If the fire cannot be controlled by the fire extinguisher equipped in the vehicle, avoid approaching to the fire and call fire station. Make sure to announce that the fire is caused by the electric vehicle.**

If there is small fire and you know how to use the fire extinguisher, follow these steps carefully.

1. Pull out the safety pin at the top of the extinguisher that keeps the handle from being accidentally pressed.
2. Aim the nozzle towards the base of the fire.
3. Stand approximately 2.5 m (8 ft) away from the fire and squeeze the handle to discharge the extinguisher. If you release the handle, the discharge will stop.
4. Sweep the nozzle back and forth at the base of the fire. After the fire appears to be out, watch carefully since it may re-ignite.

### First aid kit

Supplies for use in giving first aid such as scissors, bandage and adhesive tape, etc., are provided.

### Triangle reflector

Place the triangle reflector on the road to warn oncoming vehicles during emergencies, such as when the vehicle is parked by the roadside due to problems.

### Tire pressure gauge (if equipped)

Tires normally lose some air in day-to-day use, and you may have to add a air periodically and usually it is not a sign of a leaking tire, but of normal wear. Always check tire pressure when the tires are cold because tire pressure increases with temperature.

To check the tire pressure, take the following steps:

1. Unscrew the inflation valve cap that is located on the rim of the tire.
2. Press and hold the gauge against the tire valve. Some air will leak as you begin and more will leak if you don't press the gauge in firmly.
3. A firm non-leaking push will activate the gauge.
4. Read the tire pressure on the gauge to see whether the tire pressure is low or high.
5. Adjust the tire pressure to the specified pressure. Refer to "Tires and Wheels" section in chapter 2.
6. Reinstall the inflation valve cap.





## **WARNING**

- **When an accident occur, park the vehicle to a safe place. To avoid the leak of electricity in high voltage battery, turn the vehicle off and pull the yellow label in the high voltage battery switch to shut down the high voltage battery. Also, disconnect the auxiliary battery (12 V) cable to shut down. Be sure to disconnect both (+) cable and (-) cable.**
- **Do not touch the exposed electric wires. Do not touch high voltage wires (orange), connectors and other electric components.**
- **When an accident occur, the lethal gas and fluid from damaged high voltage battery can be leaked. Be aware not to touch or exposed to the gas and fluid. When flammable or poison gas leak inside the vehicle, open windows and evacuate to a safe place. When leaked fluid comes in contact with your eyes, flush your eyes with clean water. When the fluid contacts with your skin, wash it with salt water. Get immediate medical attention afterward.**
- **When the vehicle is flooded, immediately turn the vehicle off and evacuate to a safe place. For your safety we recommend to call the fire station and or contact an authorized retailer of Genesis Branded products.**
- **When the fire spread to the high voltage battery, the additional fire may occur. In this situation, be sure to accompany a fire truck when the vehicle is being towed.**

## PAN-EUROPEAN ECALL SYSTEM (IF EQUIPPED)

The vehicle is equipped with a device\* connected with the Pan-European eCall system for making emergency call to response teams. The Pan-European eCall system is an automatic emergency call service made in event of a traffic accident or other\*\* accidents on the roads of Europe. (only in countries with regulation on this system)

The system allows contacting with an officer of the single duty dispatch service in case of accidents on the roads of Europe. (only in countries with regulation on this system)

The Pan-European eCall system given conditions, stated in the Owner's Manual as well as Warranty and Service book transmits data to the Public Safety Answering Point (PSAP) including such information as vehicle location, vehicle type, VIN (vehicle identification number of the vehicle).

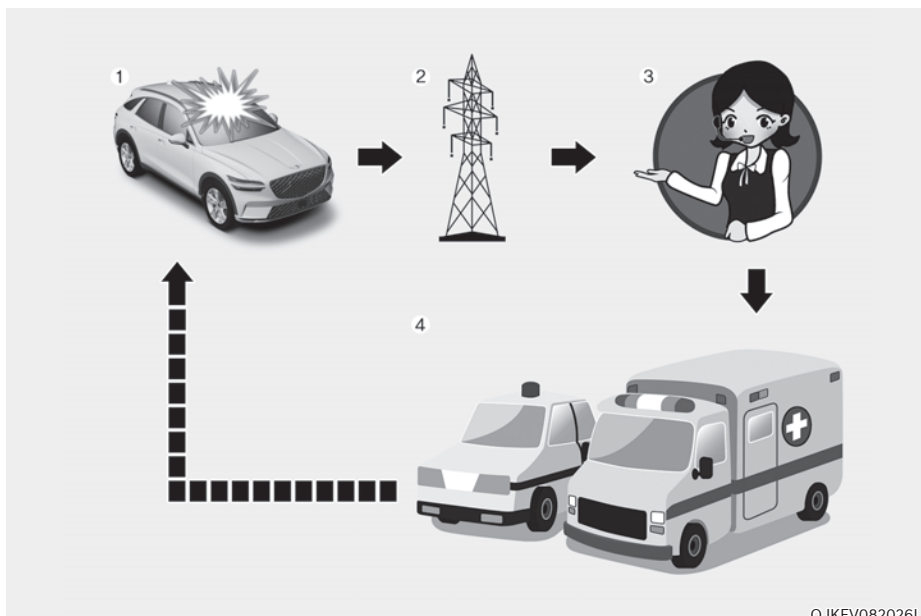

1. Road accident
2. Wireless network
3. Public Safety Answering Point (PSAP)
4. Rescue

\* Pan-European eCall device in the Owner's Manual means equipment, installed in the vehicle, which provides connection with the Pan-European eCall system.

\*\* "Other accidents" mean any accidents on the roads of Europe (only in countries with regulation on this system) resulted in injured people and/or necessity of provision of assistance. In case of registration of any accident, it is necessary to stop a vehicle, press button SOS (location of the button is specified on the picture in the chapter "Pan-European eCall (IF EQUIPPED)") of the Owner's Manual. When making a call, the system gathers information about the vehicle (from which a call was made), after which connects the car with an officer of the Public Safety Answering Point (PSAP) to tell about the reason of the emergency call.

Once the data which is stored in the Pan-European eCall system is delivered to the rescue center to assist the driver and passengers with proper rescue operations, the data will be deleted after rescue operation is completed.

**Description of the ecall in-vehicle system**

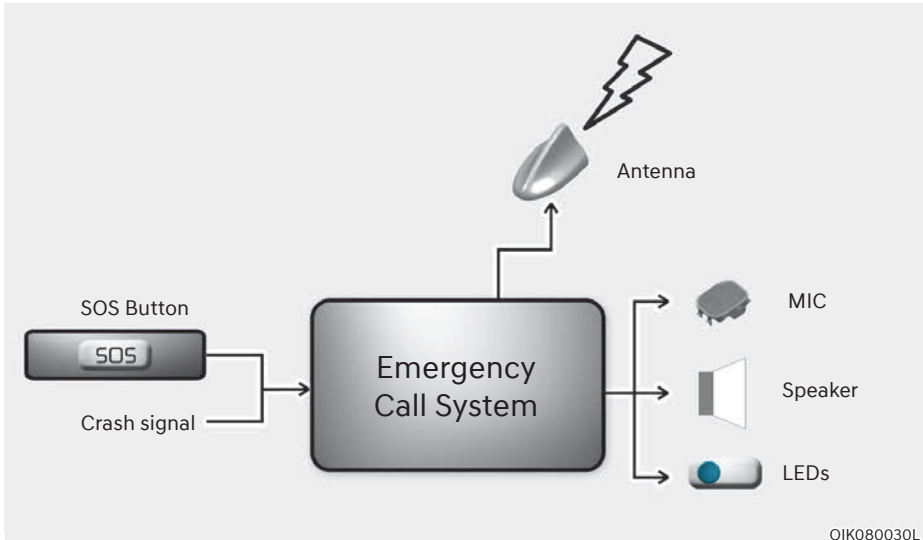

Overview of the 112-based eCall in-vehicle system, its operation and functionalities: refer to this section. The 112-based eCall service is a public service of general interest and is accessible free of charge.

The 112-based eCall in-vehicle system is activated by default. It is activated automatically by means of invehicle sensors in the event of a severe accident.

It will also be triggered automatically when the vehicle is equipped with a TPS system which does not function in the event of a severe accident.

The 112-based eCall in-vehicle system can also be triggered manually, if needed. Instructions for manual activation of the system: refer to this section.

In the event of a critical system failure that would disable the 112-based eCall in-vehicle system, the following warning will be given to the occupants of the vehicle: refer to this section.

## Information on data processing

Any processing of personal data through the 112-based eCall in-vehicle system shall comply with the personal data protection rules provided for in Directives 95/46/EC (1) and 2002/58/EC (2) of the European Parliament and of the Council, and in particular, shall be based on the necessity to protect the vital interests of the individuals in accordance with Article 7(d) of Directive 95/46/EC (3).

Processing of such data is strictly limited to the purpose of handling the emergency eCall to the single European emergency number 112.

### *Types of data and its recipients*

The 112-based eCall in-vehicle system may collect and process only the following data:

- Vehicle Identification Number
- Vehicle type (passenger vehicle or light commercial vehicle)
- Vehicle propulsion storage type (gasoline/diesel/CNG/LPG/electric/hydrogen)
- Vehicle recent locations and direction of travel
- Log file of the automatic activation of the system and its timestamp
- Any additional data (if applicable): Not applicable

Recipients of data processed by the 112-based eCall in-vehicle system are the relevant public safety answering points designated by the respective public authorities of the country on which territory they are located, to first receive and handle eCalls to the single European emergency number 112. Additional information (if available): Not applicable

- (1) Directive 95/46/EC of the European Parliament and of the Council of 24 October 1995 on the protection of individuals with regard to the processing of personal data and on the free movement of such data (OJ L 281, 23.11.1995, p. 31).
- (2) Directive 2002/58/EC of the European Parliament and of the Council of 12 July 2002 concerning the processing of personal data and the protection of privacy in the electronic communications sector (Directive on privacy and electronic communications) (OJ L 201, 31.7.2002, p. 37).
- (3) Directive 95/46/EC is repealed by Regulation (EU) 2016/679 of the European Parliament and of the Council of 27 April 2016 on the protection of natural persons with regard to the processing of personal data and on the free movement of such data (General Data Protection Regulation) (OJ L 119, 4.5.2016, p. 1). The Regulation applies from 25 May 2018.

### *Arrangements for data processing*

The 112-based eCall in-vehicle system is designed in such a way as to ensure that the data contained in the system memory is not available outside the system before an eCall is triggered. Additional remarks (if any): Not applicable

The 112-based eCall in-vehicle system is designed in such a way as to ensure that it is not traceable and not subject to any constant tracking in its normal operation status. Additional remarks (if any): Not applicable

The 112-based eCall in-vehicle system is designed in such a way as to ensure that data in the system internal memory is automatically and continuously removed.

The vehicle location data is constantly overwritten in the internal memory of the system so as always to keep maximum of the last three up-to-date locations of the vehicle necessary for the normal functioning of the system.

The log of activity data in the 112-based eCall in-vehicle system is kept for no longer than necessary for attaining the purpose of handling the emergency eCall and in any case not beyond 13 hours from the moment an emergency eCall was initiated. Additional remarks (if any): Not applicable

### ***Modalities for exercising data subject's rights***

The data subject (the vehicle's owner) has a right of access to data and as appropriate to request the rectification, erasure or blocking of data, concerning him or her, the processing of which does not comply with the provisions of Directive 95/46/EC. Any third parties to whom the data have been disclosed have to be notified of such rectification, erasure or blocking carried out in compliance with this Directive, unless it proves impossible or involves a disproportionate effort.

The data subject has a right to complain to the competent data protection authority if he or she considers that his or her rights have been infringed as a result of the processing of his or her personal data.

Contact service responsible for handling access requests (if any): Not applicable

## **Pan-European eCall System**



Elements of the Pan-European eCall system, installed in passenger compartment:

- (1) SOS button
- (2) LED

SOS button: the driver/passenger makes an emergency call to the single duty dispatch service by pressing the button.

LED: The LED illuminates for 3 seconds when the Start/Stop button is in the ON position. After that they will switch off at normal operation of the system.

If there are some problems in the system, the SOS indicator light illuminates in the instrument cluster.

## Automatic accident reporting



The Pan-European eCall device automatically makes an emergency call to the Public Safety Answering Point (PSAP) for proper rescuing operations in event of vehicle accident.

For proper emergency services and support the Pan-European eCall system automatically transmits the accident data to the Public Safety Answering Point (PSAP) when a traffic accident is detected.

In this case, the emergency call cannot be hung up by pressing the SOS button and the Pan-European eCall system remains connected until the emergency service officer, receiving the call, disconnects the emergency call.

In minor traffic accidents the Pan-European eCall system may not execute an emergency call. However, an emergency call may be made manually by pressing the SOS button.



### CAUTION

**Operation of the system is impossible in case of absence of mobile transmission and GPS and Galileo signals.**

### Manual accident reporting



The driver or passenger manually can make an emergency call in the Public Safety Answering Point (PSAP), by pressing SOS button to call the necessary emergency services.

A call to the emergency services through the Pan-European eCall system can be cancelled by pressing the SOS button again only before the call connection.

After activation of emergency call in the manual mode (for proper emergency services and support), the Pan-European eCall system automatically transmits the road accident data / or data on other accident to the officer of the Public Safety Answering Point (PSAP) (during emergency call) by pressing the SOS button.

If the driver or passenger accidentally presses the SOS button, it can be canceled by pressing the button again. (For Russia)

It can be canceled by pressing the button again in 3 seconds. It can't be canceled after that. (Except Russia)

In case of road accident or other accident for activation of emergency call in manual mode it is necessary:

1. Stop the vehicle in accordance with traffic rules to ensure safety to yourself and other participants of road traffic;
2. Press the SOS button, when pressing the button SOS registration of the device in the wireless telephonic communication networks is carried out, minimum data set about vehicle and its location is collected in accordance with of the technical requirements of the device. After that connection with the officer of the Pan-European eCall system is made for clearing up reasons (conditions) of the emergency call.
3. After clearing up reasons of the emergency call, the officer of the Public Safety Answering Point (PSAP) sends emergency services and completes the emergency call.

If the emergency call is not carried out in accordance with the procedure, mentioned above, the emergency call will be considered as erroneous.

**WARNING**

Emergency power supply of the Pan-European eCall system from the battery

- The Pan-European eCall system battery supplies power during 1 hour in case main power source of the vehicle is cut off due to the collision during the emergency situations.
- The Pan-European eCall system battery should be replaced every 3 years. For more information refer to the Maintenance Schedule in chapter 9.

The SOS indicator light in the instrument cluster (system malfunction)

If the SOS indicator light illuminates in normal driving conditions, this can indicate malfunction of the Pan-European eCall system. We recommend to have the Pan-European eCall system checked at an authorized retailer of Genesis Branded products.

Otherwise correct operation of the Pan-European eCall system device, installed in your vehicle is not guaranteed. Owner of the vehicle incurs liability for consequences, occurred as a result of nonobservance of conditions, mentioned above.

**Arbitrary Removal or Modification**

The Pan-European eCall system calls emergency services for assistance. Thus, any arbitrary removal or changes to the Pan-European eCall system settings may affect your driving safety. Also, it may even make an erroneous emergency call to the Public Safety Answering Point (PSAP). Thereby, we kindly ask you not to make any changes by yourself or by the third parties in the settings of the equipment of the Pan-European eCall system, installed in your vehicle.



# 9. Maintenance

Motor compartment .....	9-3
Maintenance services .....	9-4
Owner's responsibility .....	9-4
Owner maintenance precautions .....	9-4
Owner maintenance .....	9-5
Owner maintenance schedule .....	9-6
Scheduled maintenance services .....	9-7
Normal maintenance schedule .....	9-8
Maintenance under severe usage conditions .....	9-10
Explanation of scheduled maintenance items .....	9-11
Coolant .....	9-12
Brake fluid .....	9-13
Checking the brake fluid level .....	9-13
Reduction gear fluid .....	9-14
Washer fluid .....	9-14
Checking the washer fluid level .....	9-14
Cabin air filter .....	9-15
Filter inspection .....	9-15
Filter replacement .....	9-15
Wiper blades .....	9-17
Blade inspection .....	9-17
Blade replacement .....	9-17
Battery (12 volt) .....	9-20
For best battery service .....	9-21
Battery replacement .....	9-21
Battery capacity label .....	9-22
12V Battery recharging .....	9-22
Reset items .....	9-23

Tires and wheels .....	9-24
Tire care .....	9-24
Recommended cold tire inflation pressures .....	9-24
Check tire inflation pressure .....	9-25
Tire rotation .....	9-26
Wheel alignment and tire balance .....	9-26
Tire replacement .....	9-27
Wheel replacement.....	9-28
Tire traction .....	9-28
Tire maintenance .....	9-28
Tire sidewall labeling.....	9-28
Low aspect ratio tires.....	9-31
Fuses.....	9-32
Instrument panel fuse replacement .....	9-33
Motor compartment panel fuse replacement.....	9-34
Fuse/relay panel description .....	9-35
Light bulbs.....	9-46
Headlamp, position lamp, turn signal lamp, Daytime Running Light (DRL) replacement .....	9-48
Headlamp aiming.....	9-48
Puddle lamp replacement .....	9-51
Rear combination lamp replacement .....	9-51
Rear fog lamp replacement.....	9-51
High mounted stop lamp replacement .....	9-52
License plate lamp replacement.....	9-52
Front trunk lamp replacement .....	9-53
Interior light replacement.....	9-53
Appearance care.....	9-55
Exterior care .....	9-55
Interior care .....	9-60

## MOTOR COMPARTMENT

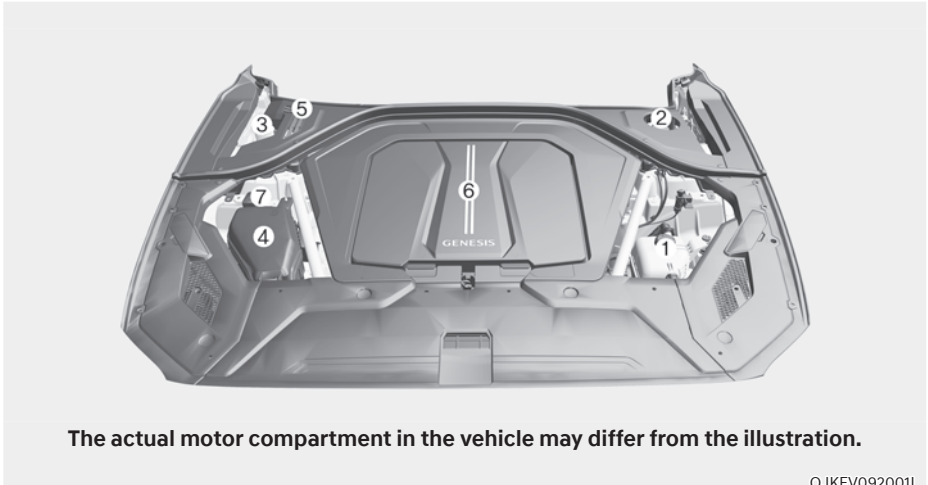

1. Coolant reservoir
2. Brake fluid reservoir
3. Windshield washer fluid reservoir
4. Fuse box
5. Cabin air filter
6. Front trunk
7. Jump-start negative (chassis) terminal

## MAINTENANCE SERVICES

You should exercise the utmost care to prevent damage to your vehicle and injury to yourself whenever performing any maintenance or inspection procedures.

We recommend you have your vehicle maintained and repaired by an authorized retailer of Genesis Branded products. An authorized retailer of Genesis Branded products meets Genesis Branded Vehicle's high service quality standards and receives technical support from Genesis Branded Vehicle in order to provide you with a high level of service satisfaction.

### Owner's responsibility

Maintenance service and record retention are the owner's responsibility.

You should retain documents that show proper maintenance has been performed on your vehicle in accordance with the scheduled maintenance service charts shown on the following pages. You need this information to establish your compliance with the servicing and maintenance requirements of your vehicle warranties.

Repairs and adjustments required as a result of improper maintenance or a lack of required maintenance are not covered.

### Owner maintenance precautions

Inadequate, incomplete or insufficient servicing may result in operational problems with your vehicle that could lead to vehicle damage, an accident, or personal injury. This chapter provides instructions only for the maintenance items that are easy to perform.

Your vehicle should not be modified in any way. Such modifications may adversely affect the performance, safety or durability of your vehicle and may, in addition, violate conditions of the limited warranties covering the vehicle.

### **NOTICE**

**Improper owner maintenance during the warranty period may affect warranty coverage. For details, read the separate Service Passport provided with the vehicle. If you're unsure about any service or maintenance procedure, have it done by an authorized retailer of Genesis Branded products.**

## OWNER MAINTENANCE



### WARNING

Performing maintenance work on a vehicle can be dangerous. If you lack sufficient knowledge and experience or the proper tools and equipment to do the work, we recommend that it is done by an authorized retailer of Genesis Branded products. **ALWAYS** follow these precautions for performing maintenance work:

- **Park your vehicle on level ground. Shift the vehicle to P (Park), apply the parking brake, and press the Start/Stop button to the OFF position.**
- **Block the tires (front and back) to prevent the vehicle from moving. Remove loose clothing or jewelry that can become entangled in moving parts.**
- **Keep flames, sparks, or smoking materials away from the battery parts.**



### WARNING

Make sure to turn the **START/STOP** button to the 'OFF' position to shut down the vehicle before performing maintenance work on the vehicle.

The following lists are vehicle checks and inspections that should be performed by the owner or an authorized retailer of Genesis Branded products at the frequencies indicated to help ensure safe, dependable operation of your vehicle.

Any adverse conditions should be brought to the attention of your dealer as soon as possible.

These Owner Maintenance vehicle checks are generally not covered by warranties and you may be charged for labor, parts and lubricants used.

The electric control system in the vehicle may cause malfunction or other negative impact on the artificial heart and the artificial internal organs. Be sure to inquire the impact of the electric control system on the artificial organs from the medical product corporation.

## Owner maintenance schedule

### *When you stop for charging:*

- Check the coolant level in the coolant reservoir.
- Check the windshield washer fluid level.
- Check for low or under-inflated tires.



### **WARNING**



**Be careful when checking your coolant level if the motor compartment is hot. This may result in coolant being blown out of the opening and cause serious burns and other injuries.**

### *While operating your vehicle:*

- Check for vibrations in the steering wheel. Notice if there is any increased steering effort or looseness in the steering wheel, or change in its straight-ahead position.
- Notice if your vehicle constantly turns slightly or “pulls” to one side when traveling on smooth, level road.
- When stopping, listen and check for unusual sounds, pulling to one side, increased brake pedal travel or “hard-to-push” brake pedal.
- If any slipping or changes in the operation of your gear shift occurs, check the shift gear fluid level.
- Check the shift gear P (Park) function.
- Check the parking brake.
- Check for fluid leaks under your vehicle (water dripping from the air conditioning system during or after use is normal).

### *At least monthly:*

- Check coolant level in the coolant reservoir.
- Check the operation of all exterior lights, including the stoplights, turn signals and hazard warning flashers.
- Check the inflation pressures of all tires including the spare (if equipped) for tires that are worn, show uneven wear, or are damaged.
- Check for loose wheel bolts.

### *At least twice a year: (for example, every Spring and Autumn)*

- Check radiator, heater and air conditioning hoses for leaks or damage.
- Check windshield washer spray and wiper operation. Clean wiper blades with a clean cloth dampened with washer fluid.
- Check headlamp alignment.
- Check the seat belts for wear and function.

### *At least once a year:*

- Clean body and door drain holes.
- Lubricate door hinges and hood hinges.
- Lubricate door and hood locks and latches.
- Lubricate door rubber weather strips.
- Check the air conditioning system.
- Inspect and lubricate shift gear linkage and controls.
- Clean the battery (12 V) and terminals.
- Check the brake fluid level.

## SCHEDULED MAINTENANCE SERVICES

Follow Normal Maintenance Schedule if the vehicle is usually operated where none of the following conditions apply. If any of the following conditions apply, you must follow the Maintenance Under Severe Usage Conditions.

- Repeatedly driving short distance of less than 8 km (5 miles) in normal temperature or less than 16 km (10 miles) in freezing temperature
- Low speed driving for long distances
- Driving on rough, dusty, muddy, unpaved, graveled or salt spread roads
- Driving in areas using salt or other corrosive materials or in very cold weather
- Driving in heavy dust condition
- Driving in heavy traffic area with the ambient temperature higher than 32 °C (90 °F) while consuming more than 50% of electric energy.
- Driving on uphill, downhill, or mountain roads repeatedly
- Using for towing or camping, and driving with loads on the roof
- Driving as a patrol car, taxi, other commercial use or vehicle towing
- Frequently driving under high speed or rapid acceleration/deceleration
- Frequently driving in stop-and-go conditions

If your vehicle is operated under the above conditions, you should inspect, replace or refill more frequently than the following Normal Maintenance Schedule. After the periods or distance shown in the chart, continue to follow the prescribed maintenance intervals.

### Normal maintenance schedule

The following maintenance services must be performed to ensure good vehicle performance. Keep receipts for all vehicle services to protect your warranty. Where both mileage and time are shown, the frequency of service is determined by whichever occurs first.

MAINTENANCE ITEM	MAINTENANCE INTERVALS									
	Number of months or driving distance, whichever comes first									
	Months	24	48	72	96	120	144	168	192	
	Miles x1,000	20	40	60	80	100	120	140	160	
	Km x1,000	30	60	90	120	150	180	210	240	
Cooling system	I	I	I	I	I	I	I	I	I	
Coolant *1	At first, replace at 180,000 km (120,000 miles) or 120 months after that, replace every 30,000 km (25,000 miles) or 24 months.									
Reduction gear fluid	I	I	I	I	I	I	I	I	I	
12V auxiliary battery condition	For Europe	I	I	I	I	I	I	I	I	
	Except Europe	Inspect 15,000 km (10,000 miles) or 12 months								
All electrical system	I	I	I	I	I	I	I	I	I	
Bolt and nuts on chassis and body	I	I	I	I	I	I	I	I	I	
Brake discs and pads	I	I	I	I	I	I	I	I	I	
Brake fluid	R	R	R	R	R	R	R	R	R	
Brake lines, hoses and connections	I	I	I	I	I	I	I	I	I	
Brake pedal	I	I	I	I	I	I	I	I	I	

I: Inspect and if necessary, adjust, correct, clean or replace.

R: Replace or change.

\*1: When replacing or adding coolant, we recommend that you visit an authorized retailer of Genesis Branded products.



## Normal maintenance schedule

MAINTENANCE INTERVALS	Number of months or driving distance, whichever comes first											
	Months	24	48	72	96	120	144	168	192			
MAINTENANCE ITEM	Miles×1,000	20	40	60	80	100	120	140	160			
	Km×1,000	30	60	90	120	150	180	210	240			
Air conditioner compressor		I	I	I	I	I	I	I	I			
Air conditioner refrigerant		I	I	I	I	I	I	I	I			
Cabin air filter	For Europe	R	R	R	R	R	R	R	R			
	Except Europe	Replace every 15,000km (10,000 miles)										
Front suspension ball joints		I	I	I	I	I	I	I	I			
Pan-European eCall system battery (if equipped)		Replace every 3 years										
Parking brake		I	I	I	I	I	I	I	I			
Steering gear rack, linkage and boots		I	I	I	I	I	I	I	I			
Tire (pressure & tread wear)		I	I	I	I	I	I	I	I			
Driveshaft and boots		I	I	I	I	I	I	I	I			

I: Inspect and if necessary, adjust, correct, clean or replace.

R: Replace or change.

### Maintenance under severe usage conditions

The following items must be serviced more frequently on cars mainly used under severe driving conditions.

Refer to the chart below for the appropriate maintenance intervals.

R: Replace

I: Inspect and if necessary, adjust, correct, clean or replace

Maintenance item	Maintenance operation	Maintenance intervals	Driving condition
Cabin air filter	R	Replace more frequently depending on the condition	B, D, F
Disc brakes and pads, calipers and rotors	I	Inspect more frequently depending on the condition	C, D, E, F, G, H, I, J, K
Driveshaft and boots	I	Inspect more frequently depending on the condition	B, C, D, E, F, G, H, I
Front suspension ball joints	I	Inspect more frequently depending on the condition	B, C, D, E, F
Reduction gear fluid	R	Every 120,000 km (80,000 miles)	A, B, E, F, H, J
Steering gear rack, linkage and boots	I	Inspect more frequently depending on the condition	C, D, E, F, G

### Severe driving conditions

- A. Repeatedly driving short distance of less than 8 km (5 miles) in normal temperature or less than 16 km (10 miles) in freezing temperature
- B. Driving on rough, dusty, muddy, unpaved, graveled or salt spread roads
- C. Driving in areas using salt or other corrosive materials or in very cold weather
- D. Driving in heavy dust condition
- E. Driving in heavy traffic area with the ambient temperature higher than 32 °C (90 °F) while consuming more than 50% of electric energy.
- F. Driving on uphill, downhill, or mountain roads repeatedly
- G. Using for towing or camping, and driving with loads on the roof
- H. Driving as a patrol car, taxi, other commercial use or vehicle towing
- I. Frequently driving under high speed or rapid acceleration/deceleration
- J. Frequently driving in stop-and-go conditions

## EXPLANATION OF SCHEDULED MAINTENANCE ITEMS

### Cooling system

Check cooling system components, such as radiator, coolant reservoir, hoses and connections for leakage and damage. Replace any damaged parts.

### Coolant

The coolant should be changed at the intervals specified in the maintenance schedule.

### Reduction gear fluid

The reduction gear fluid should be inspected according to the intervals specified in the maintenance schedule.

### Brake hoses and lines

Visually check for proper installation, chafing, cracks, deterioration and any leakage. Replace any deteriorated or damaged parts immediately.

### Brake fluid

Check the brake fluid level in the brake fluid reservoir. The level should be between the MIN and the MAX marks on the side of the reservoir. Use only hydraulic brake fluid conforming to DOT 4 specification.

### Brake discs, pads, calipers and rotors

Check the pads, the disc, and the rotor for any excessive wear-out. Inspect calipers for any fluid leakage.

For more information on checking the pads or lining wear limit, refer to the Genesis Branded Vehicle web site.

(<http://service.hyundai-motor.com>)

### Suspension mounting bolts

Check the suspension connections for looseness or damage. Retighten to the specified torque.

### Steering gear box, linkage & boots/lower arm ball joint

With the vehicle stopped and the vehicle off, check for excessive free-play in the steering wheel. Check the linkage for bends or damage. Check the dust boots and ball joints for deterioration, cracks, or damage.

Replace any damaged parts.

### Drive shafts and boots

Check the drive shafts, boots and clamps for cracks, deterioration, or damage. Replace any damaged parts and, if necessary, repack the grease.

### Air conditioning refrigerant

Check the air conditioning lines and connections for leakage and damage.

## COOLANT

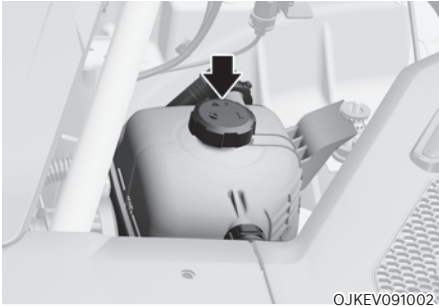

OJKEV091002

Check the condition and connections of all cooling system hoses and heater hoses. Replace any swollen or deteriorated hoses.

The coolant level should be filled between the MAX or F and the MIN or L marks on the side of the coolant reservoir when the parts in the motor compartment is cool.

If the coolant is low, we recommend to have the vehicle inspected by an authorized retailer of Genesis Branded products.

Use only designated coolant water for electric vehicles, adding other types of water or antifreeze can damage the vehicle.

### WARNING



The electric motor for the cooling fan may continue to operate or start up when the vehicle is not running and can cause serious injury.



Keep hands, clothing and tools away from the rotating fan blades of the cooling fan.

The electric motor for the cooling fan is controlled by vehicle coolant temperature, refrigerant pressure and vehicle speed. As the vehicle coolant temperature decreases, the electric motor will automatically shut off. This is a normal condition.

### WARNING

-  Check the coolant level when the motor compartment is cooled. Coolant level is influenced by temperature, and if the coolant reservoir cap is removed when coolant temperature is high, hot coolant and steam may blow out under pressure causing serious injury.
- Make sure the coolant cap is properly closed after refilling coolant. Otherwise the motor could be overheated while driving.

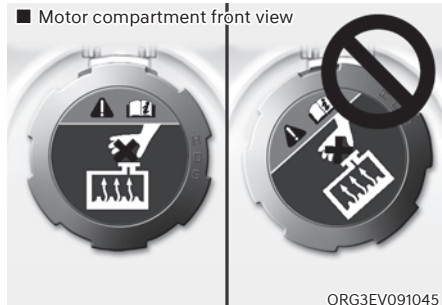

ORG3EV091045

1. Check if the coolant cap label is straight in front.

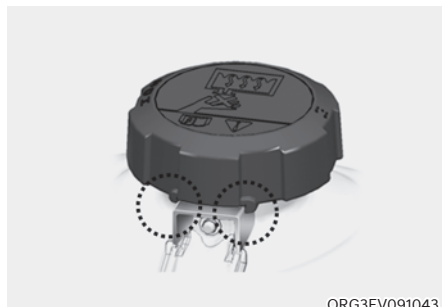

ORG3EV091043

2. Make sure that the tiny protrusions inside the coolant cap are securely interlocked.

## BRAKE FLUID

### Checking the brake fluid level

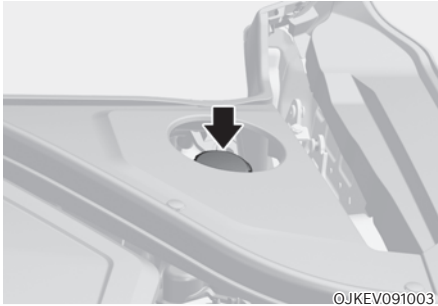

Check the fluid level in the reservoir periodically. The fluid level should be between MAX and MIN marks on the side of the reservoir.

Before removing the reservoir cap and adding brake fluid, clean the area around the reservoir cap thoroughly to prevent brake fluid contamination.

If the level is low, add the specified brake fluid to the MAX level. The level will fall with accumulated kilometers. This is a normal condition associated with the wear of the brake linings. If the fluid level is excessively low, we recommend that the brake system be checked by an authorized retailer of Genesis Branded products.

### WARNING

**If the brake system requires frequent additions of fluid this could indicate a leak in the brake system. We recommend that the vehicle be inspected by an authorized retailer of Genesis Branded products.**

### WARNING

**Do not let brake fluid enter into your eyes. If brake fluid gets in your eyes, flush your eyes with clean water for at least 15 minutes and get immediate medical attention.**

### **NOTICE**

- **Do not allow brake fluid to contact the vehicle's body paint, as it will result in paint damage.**
- **NEVER use brake/clutch fluid which has been exposed to open air for an extended time, as its quality cannot be guaranteed.**
- **Do not use the wrong type of brake fluid. A few drops of mineral based oil in your brake system can damage brake system parts.**

### Information

**Use only the specified brake fluid (refer to “Recommended Lubricants and Capacities” section in chapter 2).**

## REDUCTION GEAR FLUID

There is no reduction gear fluid level gauge in the vehicle. Check the reduction gear fluid every 60,000 km (40,000 miles) regularly. If the vehicle is driven under severe condition, check the maintenance under severe usage condition and we recommend that have you to consult an authorized retailer of Genesis Branded products.

## WASHER FLUID

### Checking the washer fluid level

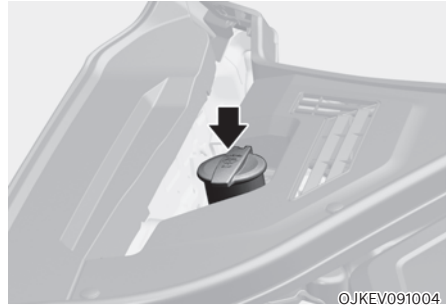

Check the fluid level in the washer fluid reservoir and add fluid if necessary. Plain water may be used if washer fluid is not available. However, use washer solvent with antifreeze characteristics in cold climates to prevent freezing.



### WARNING

To prevent serious injury or death, take the following safety precautions when using washer fluid:

- Do not use coolant or antifreeze in the washer fluid reservoir. Coolant can severely obscure visibility when sprayed on the windshield and may cause loss of vehicle control resulting in an accident or damage to paint and body trim.
- Do not allow sparks or flame to contact the washer fluid or the washer fluid reservoir. Washer fluid may contain alcohol and can be flammable.
- Do not drink washer fluid and avoid contact with skin. Washer fluid is harmful to humans and animals.
- Keep washer fluid away from children and animals.

## CABIN AIR FILTER

### Filter inspection

The cabin air filter should be replaced according to the Maintenance Schedule. If the vehicle is operated in severely air-polluted cities or on dusty rough roads for a long period, it should be inspected more frequently and replaced sooner. Replace the cabin air filter by following the procedure below and be careful to avoid damaging other components.

### Filter replacement



1. Open the glove box and remove the support rod (1).

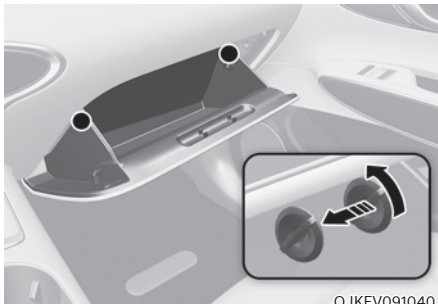

2. Remove the stoppers on both sides to allow the glove box to hang freely on the hinges.

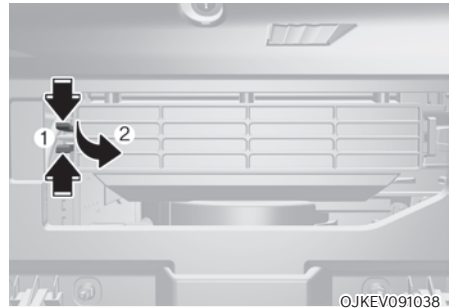

3. Press and hold the lock (1) on the left side of the cover.
4. Pull out (2) the cover.
5. Replace the cabin air filter.
6. Reassemble in the reverse order of disassembly.

**Motor compartment (if equipped)**

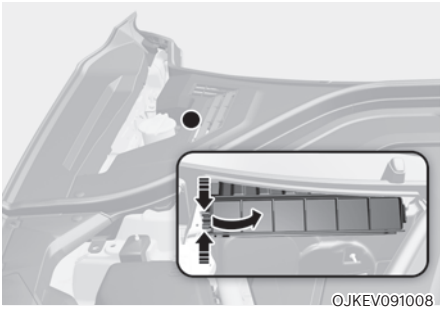

1. Remove the cover covering the cabin air filter by pushing out the retainer clip with a slim tool.
2. Press and hold the lock on the left side of the cover and then pull the cover out.
3. Replace the cabin air filter.
4. Reassemble in the reverse order of disassembly.

**NOTICE**

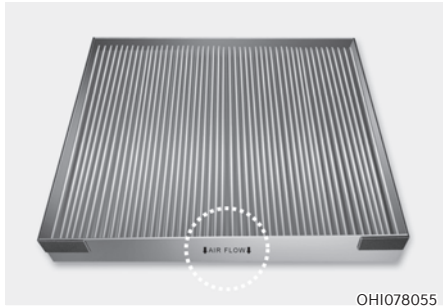

**Install a new cabin air filter in the correct direction with the arrow symbol (↓) facing downwards, to prevent noise and reduce effectiveness.**



## WIPER BLADES

### Blade inspection

Contamination of either the windshield or the wiper blades with foreign matter can reduce the effectiveness of the windshield wipers.

Common sources of contamination are insects, tree sap, and hot wax treatments used by some commercial car washes. If the blades are not wiping properly, clean both the window and the blades with a good cleaner or mild detergent, and rinse thoroughly with clean water.

#### NOTICE

To prevent damage to the wiper blades, arms or other components, do not:

- Use gasoline, kerosene, paint thinner, or other solvents on or near them.
- Attempt to move the wipers manually.
- Use non-specified wiper blades.

#### *i* Information

Commercial hot waxes applied by automatic car washes have been known to make the windshield difficult to clean.

#### *i* Information

Wiper blades are consumable items. Normal wear of the wipers may not be covered by your vehicle warranty.

### Blade replacement

When the wipers no longer clean adequately, the blades may be worn or cracked, and require replacement.

#### NOTICE

- In order to prevent damage to the hood and the wiper arms, the wiper arms should only be lifted when in the top wiping position.
- Always return the wiper arms to the windshield before driving.

### Front windshield wiper blade replacement

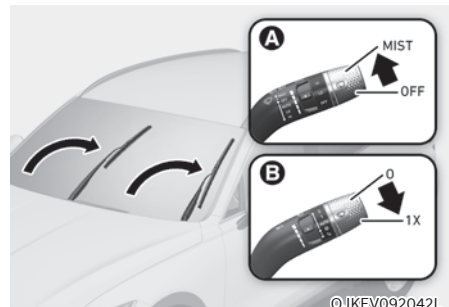

1. Within 20 seconds of turning off the vehicle, lift up (or push down) and hold the wiper lever to the MIST (or 1x) position for about 2 seconds until the wipers move to the top wipe position.
2. At this time you can lift the wipers off the windshield.

#### *i* Information

This vehicle has a “hidden” wiper design which means that the wipers cannot be lifted manually when they are in their bottom resting position.

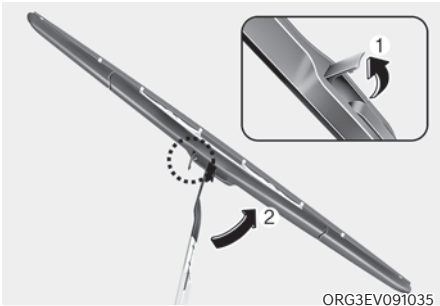

3. Lift up the wiper blade clip (1). Then lift up the wiper blade (2).



- 5. Remove the wiper blade from the wiper arm (5).
- 6. Install the new blade assembly in the reverse order of removal.
- 7. Return the wiper arm on the windshield.

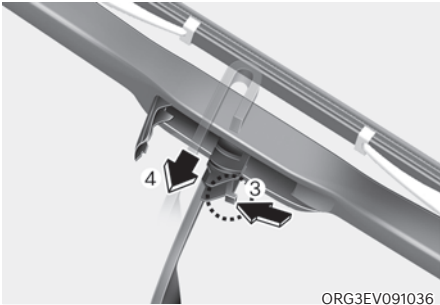

4. While pushing the lock (3), pull down the wiper blade (4).

### Rear window wiper blade replacement

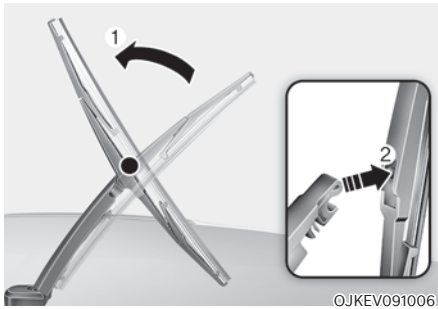

1. Raise the wiper arm and then rotate the wiper blade assembly (1).
2. Pull out the wiper blade assembly (2).

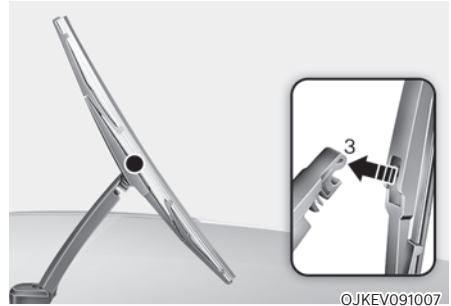

3. Install the new blade assembly by inserting the center part into the slot in the wiper arm until it clicks into place (3).
4. Make sure the blade assembly is installed firmly by trying to pull it slightly.
5. Rotate back the blade assembly so that it aligns with the wiper arm.

To prevent damage to the wiper arms or other components, we recommend that you have the wiper blades replaced by an authorized retailer of Genesis Branded products.

## BATTERY (12 VOLT)

### **WARNING**

To prevent **SERIOUS INJURY** or **DEATH** to you or bystanders, always follow these precautions when working near or handling the battery:



Always read and follow instructions carefully when handling a battery.



Wear eye protection designed to protect the eyes from acid splashes.



Keep all flames, sparks, or smoking materials away from the battery.



Hydrogen is always present in battery cells, is highly combustible, and may explode if ignited.



Keep batteries out of reach of children.



If acid gets into your eyes, flush your eyes with clean water for at least 15 minutes and get immediate medical attention. If acid gets on your skin, thoroughly wash the area. If you feel pain or a burning sensation, get medical attention immediately.

- When lifting a plastic-cased battery, excessive pressure on the case may cause battery acid to leak. Lift with a battery carrier or with your hands on opposite corners.
- Do not attempt to jump start your vehicle if your battery is frozen.
- **NEVER** attempt to recharge the battery when the vehicle's battery cables are connected to the battery.
- The electrical ignition switch works with high voltage. **NEVER** touch these components with the (READY) indicator ON or when the START/STOP button is in the ON position.

### **NOTICE**

- Always follow these instructions when handling your vehicle's battery to prevent damage to your battery.
- When you do not use the vehicle for a long time in a low temperature area, disconnect the battery and keep it indoors.
- Always charge the battery fully to prevent battery case damage in low temperature areas.
- Prevent liquid from wetting the battery terminals. The performance of the battery may be degraded, and may cause injury. Be cautious when loading liquid in the motor compartment.
- Do not tilt the battery.
- If you connect unauthorized electronic devices to the battery, the battery may be discharged. Never use unauthorized devices.

## For best battery service

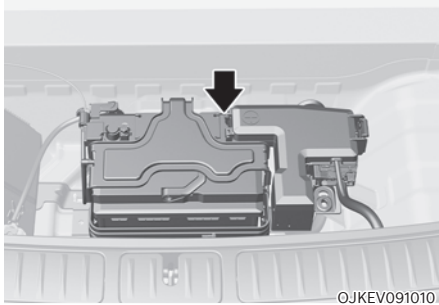

- Keep the battery securely mounted.
- Keep the battery top clean and dry.
- Keep the terminals and connections clean, tight, and coated with petroleum jelly or terminal grease.
- Rinse any spilled electrolyte from the battery immediately with a solution of water and baking soda.
- If the vehicle is not going to be used for an extended time, disconnect the battery cables.
- Inspect the battery frequently and keep the battery clean at all times. Leaving the battery contaminated will shorten battery life.
- Before recharging the battery or performing any inspections, turn off the vehicle and all electrical equipment.

## Battery replacement

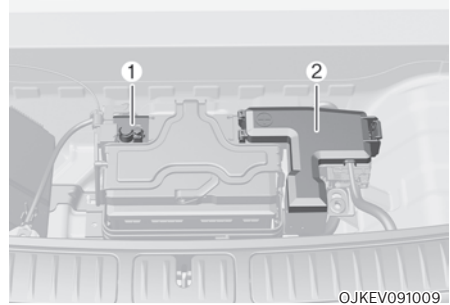

When replacing the battery, disconnect negative (-) cable (1) and remove positive (+) battery fuse box (2). Reassemble in the reverse order of disassembly.

### **i** Information

**For vehicles with power tailgate, note that the power tailgate needs to be reset after the battery has been replaced. For more details, refer to “Power Tailgate” section in chapter 5.**

### **NOTICE**

**Make sure the battery is installed securely when the it is replaced. If the battery vibrates while driving, the case and electrode plate can be damaged.**



- The negative battery cable must be removed first and installed last when the battery is disconnected. Disconnect the battery charger in the following order:
  1. Turn off the battery charger main switch.
  2. Unhook the negative clamp from the negative battery terminal.
  3. Unhook the positive clamp from the positive battery terminal.
- We recommend that you use batteries for replacement from an authorized retailer of Genesis Branded products.

### NOTICE

#### AGM battery

- Absorbent Glass Matt (AGM) batteries are maintenance-free and we recommend that the AGM battery be serviced by an authorized retailer of Genesis Branded products. For charging your AGM battery, use only fully automatic battery chargers that are specially developed for AGM batteries.
- When replacing the AGM battery, we recommend that you use parts for replacement from an authorized retailer of Genesis Branded products.
- Do not open or remove the cap on top of the battery. This may cause leaks of internal electrolyte that could result in severe injury.

### By jump starting

After a jump start from a good battery, drive the vehicle for 20-30 minutes before it is shutoff. The vehicle may not restart if you shut it off before the battery had a chance to adequately recharge. See “Jump Starting” in chapter 8 for more information on jump starting procedures.

### Information



**An inappropriately disposed battery can be harmful to the environment and human health. Dispose of the battery according to your local law(s) or regulation.**

### Reset items

The following items may need to be reset after the battery has been discharged or the battery has been disconnected.

- Driving info/After recharging/ Accumulated info (items in Utility view) (see chapter 4)
- Integrated memory system (see chapter 5)
- Power window (see chapter 5)
- Power tailgate (see chapter 5)
- Climate control system (see chapter 5)
- Clock (see Infotainment system manual)
- Infotainment system (see Infotainment system manual)

## TIRES AND WHEELS



### WARNING

Tire failure may cause loss of vehicle control resulting in an accident. To reduce risk of **SERIOUS INJURY** or **DEATH**, take the following precautions:

- Inspect your tires monthly for proper inflation as well as wear and damage.
- The recommended cold tire pressure for your vehicle can be found in this manual and on the tire label located on the driver's side center pillar. Always use a tire pressure gauge to measure tire pressure. Tires with too much or too little pressure wear unevenly causing poor handling.
- Check the pressure of the spare (if equipped) every time you check the pressure of the other tires on your vehicle.
- Replace tires that are worn, show uneven wear, or are damaged. Worn tires can cause loss of braking effectiveness, steering control, or traction.
- **ALWAYS** replace tires with the same size, type, construction and tread pattern as each tire that was originally supplied with this vehicle. Using tires and wheels other than the recommended sizes could cause unusual handling characteristics, poor vehicle control, or negatively affect your vehicle's Anti-Lock Brake System (ABS) resulting in a serious accident.

### Tire care

For proper maintenance, safety, and maximum electric energy economy, you must always maintain recommended tire inflation pressures and stay within the load limits and weight distribution recommended for your vehicle.



All specifications (sizes and pressures) can be found on a label attached to the driver's side center pillar.

### Recommended cold tire inflation pressures

All tire pressures (including the spare) should be checked when the tires are cold. "Cold tires" means the vehicle has not been driven for at least three hours or driven less than 1.6 km (one mile).

Warm tires normally exceed recommended cold tire pressures by 28 to 41 kPa (4 to 6 psi). Do not release air from warm tires to adjust the pressure or the tires will be under-inflated. For recommended inflation pressure, refer to "Tire and Wheels" section in chapter 2.





## WARNING

Recommended pressures must be maintained for the best ride, vehicle handling, and minimum tire wear.

Over-inflation or under-inflation can reduce tire life, adversely affect vehicle handling, and lead to sudden tire failure that could result in loss of vehicle control resulting in an accident.

Severe under-inflation can lead to severe heat build-up, causing blowouts, tread separation and other tire failures that can result in the loss of vehicle control resulting in an accident. This risk is much higher on hot days and when driving for long periods at high speeds.



## CAUTION

- Under-inflation results in excessive wear, poor handling and reduced electric energy economy. Wheel deformation is also possible. Keep your tire pressures at the proper levels. If a tire frequently needs refilling, we recommend it be checked by an authorized retailer of Genesis Branded products.
- Over-inflation produces a harsh ride, excessive wear at the center of the tire tread, and a greater possibility of damage from road hazards.

## Check tire inflation pressure

Check your tires, including the spare tire (if equipped), once a month or more.

### *How to check*

Use a good quality tire pressure gauge to check tire pressure. You can not tell if your tires are properly inflated simply by looking at them. Radial tires may look properly inflated when they are under-inflated.

Remove the valve cap from the tire valve stem. Press the tire gauge firmly onto the valve to get a pressure measurement. If the cold tire inflation pressure matches the recommended pressure on the tire and loading information label, no further adjustment is necessary. If the pressure is low, add air until you reach the recommended pressure. Make sure to put the valve caps back on the valve stems. Without the valve cap, dirt or moisture could get into the valve core and cause air leakage. If a valve cap is missing, install a new one as soon as possible.

If you overfill the tire, release air by pushing on the metal stem in the center of the tire valve. Recheck the tire pressure with the tire gauge. Be sure to put the valve caps back on the valve stems. Without the valve cap, dirt or moisture could get into the valve core and cause air leakage. If a valve cap is missing, install a new one as soon as possible.

## Tire rotation

To equalize tread wear, Genesis Branded Vehicle recommends that the tires be rotated according to the maintenance schedule or sooner if irregular wear develops.

During rotation, check the tires for correct balance.

When rotating tires, check for uneven wear and damage. Abnormal wear is usually caused by incorrect tire pressure, improper wheel alignment, out-of-balance wheels, severe braking or severe cornering. Look for bumps or bulges in the tread or side of the tire. Replace the tire if you find any of these conditions. Replace the tire if fabric or cord is visible. After rotation, be sure to bring the front and rear tire pressures to specification and check wheel bolt tightness (proper torque is 14~16 kgf.m [101~116 lbf.ft]).

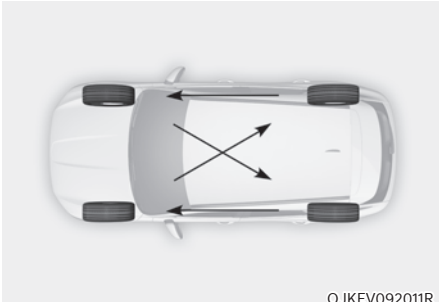

OJKEV092011R

Disc brake pads should be inspected for wear whenever tires are rotated.

## Information

**The outside and inside of the unsymmetrical tire is distinguishable. When installing an unsymmetrical tire, be sure to install the side marked “outside” face the outside. If the side marked “inside” is installed on the outside, it will have a negative effect on vehicle performance.**

## WARNING

- **Do not use the compact spare tire for tire rotation.**
- **Do not mix bias ply and radial ply tires under any circumstances. This may cause unusual handling characteristics that may cause loss of vehicle control resulting in an accident.**

## Wheel alignment and tire balance

The wheels on your vehicle were aligned and balanced carefully at the factory to give you the longest tire life and best overall performance.

In most cases, you will not need to have your wheels aligned again. However, if you notice unusual tire wear or your vehicle pulling one way or the other, the alignment may need to be reset.

If you notice your vehicle vibrating when driving on a smooth road, your wheels may need to be rebalanced.

## **NOTICE**

**Incorrect wheel weights can damage your vehicle’s aluminum wheels. Use only approved wheel weights.**

## Tire replacement



[A]: Tread wear indicator

If the tire is worn evenly, a tread wear indicator will appear as a solid band across the tread. This shows there is less than 1.6 mm (1/16 in.) of tread left on the tire. Replace the tire when this happens.

Do not wait for the band to appear across the entire tread before replacing the tire.



### WARNING

To reduce the risk of **DEATH** or **SERIOUS INJURY**:

- **Replace tires that are worn, show uneven wear, or are damaged. Worn tires can cause loss of braking effectiveness, steering control, and traction.**
- **Always replace tires with the same size as each tire that was originally supplied with this vehicle. Using tires and wheels other than the recommended sizes could cause unusual handling characteristics, poor vehicle control, or negatively affect your vehicle's Anti-Lock Brake System (ABS) resulting in a serious accident.**

- **When replacing tires (or wheels), it is recommended to replace the two front or two rear tires (or wheels) as a pair. Replacing just one tire can seriously affect your vehicle's handling.**
- **Tires degrade over time, even when they are not being used. Regardless of the remaining tread, Genesis Branded Vehicle recommends that tires be replaced after six (6) years of normal service.**
- **Heat caused by hot climates or frequent high loading conditions can accelerate the aging process. Failure to follow this warning may cause sudden tire failure, which could lead to a loss of vehicle control resulting in an accident.**

### ***Compact spare tire (if equipped) replacement***

A compact spare tire has a shorter tread life than a regular size tire. Replace it when you can see the tread wear indicator bars on the tire. The replacement compact spare tire should be the same size and design tire as the one provided with your new vehicle and should be mounted on the same compact spare tire wheel. The compact spare tire is not designed to be mounted on a regular size wheel, and the compact spare tire wheel is not designed for mounting a regular size tire.



## WARNING

The original tire should be repaired or replaced as soon as possible to avoid failure of the spare (if equipped) and loss of vehicle control resulting in an accident. The compact spare tire (if equipped) is for emergency use only. Do not operate your vehicle over 80 km/h (50 mph) when using the compact spare tire.

## Wheel replacement

When replacing the metal wheels for any reason, make sure the new wheels are equivalent to the original factory units in diameter, rim width and offset.

## Tire traction

Tire traction can be reduced if you drive on worn tires, tires that are improperly inflated or on slippery road surfaces. Tires should be replaced when tread wear indicators appear. To reduce the possibility of losing control, slow down whenever there is rain, snow or ice on the road.

## Tire maintenance

In addition to proper inflation, correct wheel alignment helps to decrease tire wear. If you find a tire is worn unevenly, have your dealer check the wheel alignment.

When you have new tires installed, make sure they are balanced. This will increase vehicle ride comfort and tire life. Additionally, a tire should always be rebalanced if it is removed from the wheel.

## Tire sidewall labeling

This information identifies and describes the fundamental characteristics of the tire and also provides the tire identification number (TIN) for safety standard certification. The TIN can be used to identify the tire in case of a recall.

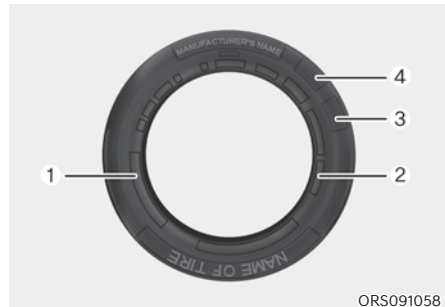

ORS091058

### 1. Manufacturer or brand name

Manufacturer or brand name is shown.

### 2. Tire size designation

A tire's sidewall is marked with a tire size designation. You will need this information when selecting replacement tires for your car. The following explains what the letters and numbers in the tire size designation mean.

Example tire size designation:

(These numbers are provided as an example only; your tire size designator could vary depending on your vehicle.)

**265/45 R20 101H**

265 - Tire width in millimeters.

45 - Aspect ratio. The tire's section height as a percentage of its width.

R - Tire construction code (Radial).

20 - Rim diameter in inches.

101 - Load Index, a numerical code associated with the maximum load the tire can carry.

H - Speed Rating Symbol. See the speed rating chart in this section for additional information.

**Wheel size designation**

Wheels are also marked with important information that you need if you ever have to replace one. The following explains what the letters and numbers in the wheel size designation mean.

Example wheel size designation:

**8.5J X 20**

8.5 - Rim width in inches.

J - Rim contour designation.

20 - Rim diameter in inches.

**Tire speed ratings**

The chart below lists many of the different speed ratings currently being used for passenger vehicle tires. The speed rating is part of the tire size designation on the sidewall of the tire. This symbol corresponds to that tire's designed maximum safe operating speed.

Speed Rating Symbol	Maximum Speed
S	180 km/h (112 mph)
T	190 km/h (118 mph)
H	210 km/h (130 mph)
V	240 km/h (149 mph)
W	270 km/h (168 mph)
Y	300 km/h (186 mph)

**3. Checking tire life (TIN : Tire Identification Number)**

Any tires that are over six years old, based on the manufacturing date, (including the spare tire) should be replaced by new ones. You can find the manufacturing date on the tire sidewall (possibly on the inside of the wheel), displaying the DOT Code. The DOT Code is a series of numbers on a tire consisting of numbers and English letters. The manufacturing date is designated by the last four digits (characters) of the DOT code.

**DOT : XXXX XXXX 0000**

The front part of the DOT shows a plant code number, tire size and tread pattern and the last four numbers indicate week and year manufactured.

For example:

DOT XXXX XXXX 5222 represents that the tire was produced in the 52nd week of 2022.

#### 4. Genesis exclusive tire

Genesis Branded Vehicle recommends that tires designed specifically for Genesis vehicles be used. You may find the marking “GOE” (Genesis Original Equipment) embossed on the tire sidewall.

#### 5. Tire ply composition and material

The number of layers or plies of rubber-coated fabric in the tire. Tire manufacturers also must indicate the materials in the tire, which include steel, nylon, polyester, and others. The letter “R” means radial ply construction; the letter “D” means diagonal or bias ply construction; and the letter “B” means belted-bias ply construction.

#### 6. Maximum permissible inflation pressure

This number is the greatest amount of air pressure that should be put in the tire. Do not exceed the maximum permissible inflation pressure. Refer to the Tire and Loading Information label for recommended inflation pressure.

#### 7. Maximum load rating

This number indicates the maximum load in kilograms and pounds that can be carried by the tire. When replacing the tires on the vehicle, always use a tire that has the same load rating as the factory installed tire.

#### 8. Uniform tire quality grading

Quality grades can be found where applicable on the tire sidewall between tread shoulder and maximum section width.

For example:

TREADWEAR 200

TRACTION AA

TEMPERATURE A

#### Tread wear

The tread wear grade is a comparative rating based on the wear rate of the tire when tested under controlled conditions on a specified government test course. For example, a tire graded 150 would wear one-and-a-half times (1½) as well on the government course as a tire graded 100.

The relative performance of tires depends upon the actual conditions of their use, however, and may depart significantly from the norm due to variations in driving habits, service practices and differences in road characteristics and climate.

These grades are molded on the sidewalls of passenger vehicle tires. The tires available as standard or optional equipment on your vehicle may vary with respect to grade.

#### Traction - AA, A, B & C

The traction grades, from highest to lowest, are AA, A, B and C. Those grades represent the tire’s ability to stop on wet pavement as measured under controlled conditions on specified government test surfaces of asphalt and concrete. A tire marked C may have poor traction performance.



#### WARNING

**The traction grade assigned to this tire is based on straight ahead braking traction tests, and does not include acceleration, cornering, hydroplaning, or peak traction characteristics.**

### Temperature - A, B & C

The temperature grades are A (the highest), B and C representing the tire's resistance to the generation of heat and its ability to dissipate heat when tested under controlled conditions on a specified indoor laboratory test wheel.

Sustained high temperature can cause the material of the tire to degenerate and reduce tire life, and excessive temperature can lead to sudden tire failure. Grades B and A represent higher levels of performance on the laboratory test wheel than the minimum required by law.



### WARNING

The temperature grade for this tire is established for a tire that is properly inflated and not overloaded. Excessive speed, under-inflation, over-inflation, or excessive loading, either separately or in combination, can cause heat build-up and possible sudden tire failure. This may cause loss of vehicle control resulting in an accident.

### Low aspect ratio tires (if equipped)

The aspect ratio is lower than 50 on low aspect ratio tires.

Because low aspect ratio tires are optimized for handling and braking, their sidewall is a little stiffer than a standard tire. Also low aspect ratio tires tend to be wider and consequently have a greater contact patch with the road surface. In some instances they may generate more road noise compared with standard tires.



### CAUTION

The side wall of a low aspect ratio tire is shorter than the normal one. Thus, the low-aspect wheel and tire are easily damaged. Follow the below instructions.

- When driving on a rough road or driving off a road, be careful not to damage the tires and wheels. After driving, inspect the tires and wheels.
- When passing over a pothole, speed bump, manhole, or curb stone, drive the vehicle slowly so as not to damage the tires and wheels.
- When there is an impact on a tire, inspect the tire condition. Or, we recommend that have you to contact an authorized retailer of Genesis Branded products.
- Inspect the tire condition and pressure every 3,000 km (1,800 miles) to prevent tire damage.
- It is difficult to recognize a tire damage only with your eyes. When there is a slight hint of a tire damage, check and replace the tire to prevent the damage caused by air leakage.
- When a tire is damaged while driving on a rough road, off a road, or over obstacles, such as a pothole, manhole, or curb stone, your warranty does not cover the damage.
- The tire information is specified on the tire side wall.

## FUSES

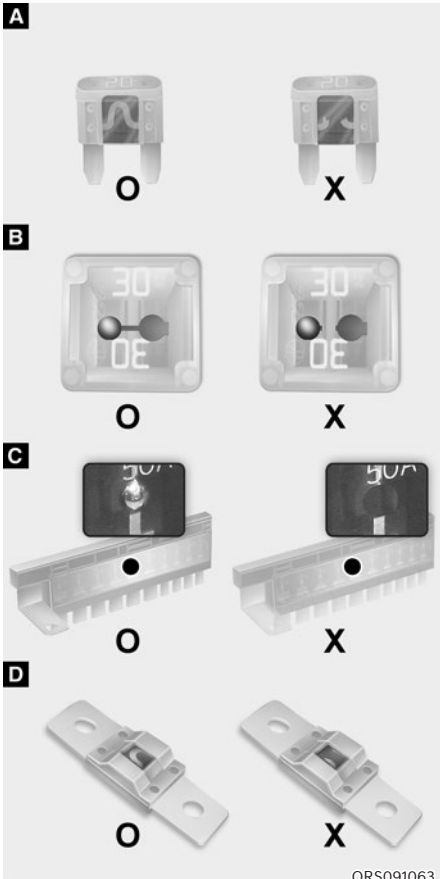

[A]: Blade type, [B]: Cartridge type,  
[C]: Multi type, [D]: Midi type  
O: Normal, X: Blown

A vehicle's electrical system is protected from electrical overload damage by fuses.

This vehicle has 4 fuse panels, one located in the driver's side panel bolster, the other in the vehicle compartment.

If any of your vehicle's lights, accessories, or controls do not work, check the appropriate circuit fuse. If a fuse has blown, the element inside the fuse will be melted or broken.

If the electrical system does not work, first check the driver's side fuse panel. Before replacing a blown fuse, turn the vehicle and all switches off, and then disconnect the negative battery cable. Always replace a blown fuse with one of the same rating.

If the replacement fuse blows, this indicates an electrical problem. Avoid using the system involved. We recommend that you immediately consult an authorized retailer of Genesis Branded products.

### **WARNING**

**NEVER** replace a fuse with anything but another fuse of the same rating.

- A higher capacity fuse could cause damage and possibly cause a fire.
- Do not install a wire or aluminum foil instead of the proper fuse - even as a temporary repair. It may cause extensive wiring damage and possibly a fire.

### **NOTICE**

Do not use a screwdriver or any other metal object to remove fuses because it may cause a short circuit and damage the system.



## Instrument panel fuse replacement



[A]: Driver's side

1. Turn the vehicle off.
2. Turn all other switches off.
3. Open the fuse panel cover.
4. Refer to the label on the inside of the fuse panel cover to locate the suspected fuse location.

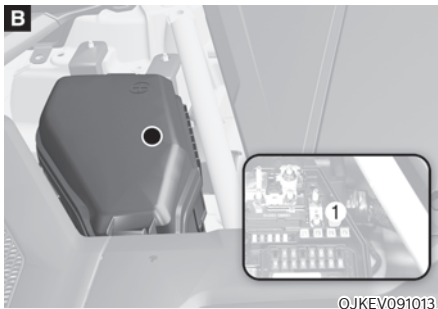

[B]: Motor compartment

5. Pull the suspected fuse straight out. Use the removal tool (1) provided in the motor compartment fuses panel cover.

6. Check the removed fuse; replace it if it is blown. Spare fuses are provided in the instrument panel fuse panels (or in the motor compartment fuse panel).
7. Push in a new fuse of the same rating, and make sure it fits tightly in the clips. If it fits loosely, we recommend that you consult an authorized retailer of Genesis Branded products.

In an emergency, if you do not have a spare fuse, use a fuse of the same rating from a circuit you may not need for operating the vehicle, such as the cigarette lighter fuse.

If the headlamps or other electrical components do not work and the fuses are undamaged, check the fuse panel in the motor compartment. If a fuse is blown, it must be replaced with the same rating.

## Motor compartment panel fuse replacement

### Blade fuse / Cartridge fuse

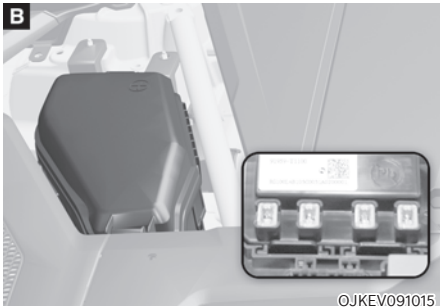

[A]: Blade type fuse, [B]: Cartridge type fuse

1. Turn the vehicle off.
2. Turn all other switches off.
3. Remove the fuse panel cover by pressing the tap and pulling up.
4. Check the removed fuse; replace it if it is blown. To remove or insert the fuse, use the fuse puller in the motor compartment fuse panel.
5. Push in a new fuse of the same rating, and make sure it fits tightly in the clips. If it fits loosely, we recommend that you consult an authorized retailer of Genesis Branded products.

## NOTICE

After checking the fuse panel in the motor compartment, securely install the fuse panel cover. You may hear a clicking sound if the cover is securely latched. If it is not securely latched, electrical failure may occur from water contact.

## Multi fuse



[C]: Multi type, [D]: Midi type

If the multi fuse or midi fuse is blown, we recommend that you consult an authorized retailer of Genesis Branded products.

### Fuse/relay panel description Instrument panel fuse panel



OJKEV091018

Inside the fuse/relay box cover, you can find the fuse/relay label describing fuse/relay names and ratings.

### **i** Information

Not all fuse panel descriptions in this manual may be applicable to your vehicle; the information is accurate at the time of printing. When you inspect the fuse box on your vehicle, refer to the fuse box label.

91.990-DS030

USE THE DESIGNATED FUSE ONLY  
USE SOLO LOS FUSIBLES ESPECIFICADOS  
используйте только предназначенные предохранители  
استخدم الفيوز ذو القياس المناسب  
请使用指定的保险丝





9 MODULE 10A				11 MODULE 10A				12 MODULE 10A	A/C 10A
IND SHIFTER 10A	4 E- SHIFTER 10A			SPARE 10A	10 MODULE 10A		7 MODULE 10A	MULTI MEDIA 10A	13 MODULE 10A
CLUSTER 10A	2 IBU 10A	10 10A	10 10A	3 PRESAFETY SEAT BELT 15A	8 MODULE 10A		5 MODULE 10A	E-CALL 10A	3 MODULE 10A
LH 10A	30A 10A	10A	2 PAGE 10A		1 10A	15A	3 E- SHIFTER 10A	1 A/C 10A	
20A 10A	25A 10A	10A	2 MODULE 10A	POWER HANDLE 10A	SPARE 15A	10A	1 IBU 10A		
20A 10A	1PASS 10A	25A 10A	GRV 10A	1PASS 10A	SPARE 10A	20A 10A	1 BATTERY MANAGEMENT 10A	4 MODULE 10A	
								6 MODULE 10A	BRAKE SWITCH 10A

OJKEV092019L















**Instrument panel fuse panel**

Fuse Name	Symbol	Fuse Rating	Circuit Protected
MODULE9	<sup>9</sup> <b>MODULE</b>	10A	Overhead Console, Electro Chromic Mirror, Inverter (Rear) Driver/Passenger Power Seat Module, Smart Phone Wireless Charger, Rear Seat Warmer Control Module, Fingerprint Recognition Device, Rear Air Ventilation Seat Control Module, AMP, Data Link Connector, A/V & Navigation Head Unit, NEMS Unit, E-Call Unit
MODULE11	<sup>11</sup> <b>MODULE</b>	10A	Head Lamp LH, Head Lamp RH, Multifunction Switch, ADAS Unit (Parking), Rear Junction Block (Rear Wiper Relay)
MODULE12	<sup>12</sup> <b>MODULE</b>	10A	IAU, IBU
A/C2	<sup>2</sup> <b>A/C</b>	10A	A/C Control Module, Front/Rear A/C Controller
A/BAG IND	<sup>IND</sup> 	10A	Instrument Cluster, Overhead Console
E-SHIFTER4	<sup>4</sup> <b>E-SHIFTER</b>	10A	Electronic Shift Dial
SPARE(IG2)	<b>SPARE (IG2)</b>	15A	Spare
MODULE10	<sup>10</sup> <b>MODULE</b>	10A	ICU Junction Block (ESU)
MODULE7	<sup>7</sup> <b>MODULE</b>	10A	Driver Door Module, Stop Lamp Switch, IBU, IAU, Multifunction Switch
MULTIMEDIA	<b>MULTI MEDIA</b>	10A	A/V & Navigation Head Unit
MODULE13	<sup>13</sup> <b>MODULE</b>	10A	Head-Up Display, Garnish Mood Lamp RH, Fingerprint Recognition Device, A/V & Navigation Keyboard, Security Indicator, Instrument Cluster, A/C Control Module, Front/Rear A/C Controller, Front Console Switch, Crash Pad Switch, Console Mood Lamp, ICU Junction Block (ESU) Mood Lamp Unit, Driver/Passenger Mood Lamp #1/#2, Rear Door Mood Lamp LH/RH #1/#2

## Instrument panel fuse panel









Fuse Name	Symbol	Fuse Rating	Circuit Protected
CLUSTER	CLUSTER	10A	Head-Up Display, Instrument Cluster
IBU2	<sup>2</sup> IBU	10A	IBU
A/BAG2	<sup>2</sup> 	15A	SRS Control Module
PRESAFETY SEAT BELT3	<sup>3</sup> PRESAFETY SEAT BELT	10A	Pre-Active Seat Belt Unit
MODULE8	<sup>8</sup> MODULE	10A	Rear Corner Radar LH/RH, ECS Unit, Crash Pad Switch, Front View Camera ADAS Unit (Driving/Parking), Steering Tilt & Telescopic Unit,
MODULE5	<sup>5</sup> MODULE	10A	UIP Sensor, UIP Siren, Rain Sensor, Data Link Connector, Multifunction Switch, Electro Chromic Mirror
E-CALL	E-CALL		E-Call Unit
MODULE3	<sup>3</sup> MODULE	10A	Active Air Flap Module, Front Console Keyboard, VESS Unit, Steering Tilt & Telescopic Unit, Rear Occupant Alert Sensor, Clock Spring, Front/Rear Corner Radar LH/RH, NEMS Unit Smart Phone Wireless Charger
P/WIN LH	<sup>LH</sup> 	30A	Driver Safety Power Window Module (LHD), Passenger Safety Power Window Module (RHD), Rear Power Window Module LH
P/SEAT		10A	Driver Lumbar Support Unit, Passenger Lumbar Support Unit
P/SEAT PASS2	<sup>2</sup> PASS 	25A	Passenger Power Seat Switch, Passenger Power Seat Module
A/BAG1	<sup>1</sup> 	15A	SRS Control Module
E-SHIFTER3	<sup>3</sup> E-SHIFTER	10A	Electronic Shift Dial
A/C1	<sup>1</sup> A/C	10A	P/R Junction Block (RLY.4), A/C Control Module

**Instrument panel fuse panel**

Fuse Name	Symbol	Fuse Rating	Circuit Protected
S/ROOF		25A	Sunroof Control Unit (Master)
P/SEAT DRV1	<sup>1</sup> 	25A	Driver Power Seat Module, Driver Power Seat Switch
MODULE2	<sup>2</sup> 	10A	Driver Door Module, Driver/Passenger Power Outside Mirror, Power Tailgate Module, Driver/Passenger Power Seat Switch, Driver/Passenger Lumbar Support Unit, Driver/Passenger Power Seat Module, Front radar
P/HANDLE		15A	Steering Tilt & Telescopic Unit
SPARE(B+)		10A	Spare
IBU1	<sup>1</sup> 	10A	BLE Unit, IAU, IBU, Driver/Passenger Door Outside Handle
P/SEAT DRV2	<sup>2</sup> 	25A	Driver Power Seat Module, Driver Power Seat Switch
P/SEAT PASS1	<sup>1</sup> 	25A	Passenger Power Seat Module, Passenger Power Seat Switch
S/HTR DRV		15A	Driver Power Seat Module
S/HTR PASS1	<sup>1</sup> 	15A	Passenger Power Seat Module
Door Lock		20A	ICU Junction Block (Center Door Lock Relay, Center Door Unlock Relay, Dead Lock Relay)
BATT Management		10A	BMU
MODULE4	<sup>4</sup> 	10A	CDM
MODULE6	<sup>6</sup> 	10A	Rear USB Charger, Armrest Lamp, Front Console Keyboard, AMP, E-Call Unit, IBU, Electronic Shift Dial, ADAS Unit (Parking), IAU, A/V & Navigation Head Unit, ICU Junction Block (ESU) P/R Junction Block (RLY.6)
BRAKE SWITCH		10A	IBU, Stop Lamp Switch





**Motor compartment fuse panel**

Type	Fuse Name	Symbol	Fuse Rating	Circuit Protected
MINE	MDPS1	<sup>1</sup>  1	100A	MDPS Unit
	LDC	LDC	255A	ICCU
	B+7	<sup>7</sup> 	150A	P/R Junction Block (Fuse - S1, S2, S3, S4, F1, F2, F3, F4, F5), PCB Block (Fuse - S1, S2, S3, S4)
MULTI	FR WIPER	<sup>FRT</sup> 	30A	Front Wiper Motor
	VCU3	<sup>3</sup> VCU	40A	VCU
	P/OUTLET1	<sup>1</sup> POWER OUTLET	40A	RLY.6
	E-SHIFTER1	<sup>1</sup> E-SHIFTER	40A	RLY.2, Fuse (F11)
	RR HTD		40A	RLY.1
	IEB3	<sup>3</sup> IEB	60A	IEB Unit
	IEB2	<sup>2</sup> IEB	60A	IEB Unit
	IEB1	<sup>1</sup> IEB	60A	IEB Unit
	C/FAN		100A	Cooling Fan Motor
SB	H/LP LH	<sup>LH</sup> 	30A	Head Lamp LH
	EOP1	<sup>1</sup> EOP	40A	Electronic Traction Motor Oil Pump (Front)
	EOP2	<sup>2</sup> EOP	40A	Electronic Traction Motor Oil Pump (Rear)
	BLOWER		40A	RLY.4
	H/LP RH	<sup>RH</sup> 	30A	Head Lamp RH













### Motor compartment fuse panel

Type	Fuse Name	Symbol	Fuse Rating	Circuit Protected
MICRO	EWP1	<sup>1</sup> <b>EWP</b>	20A	Electronic Water Pump (BSA #1)
	OBC	<b>OBC</b>	10A	ICCU, VCMS
	VCU1	<sup>1</sup> <b>VCU</b>	20A	VCU
	VCU2	<sup>2</sup> <b>VCU</b>	20A	VCU
	EWP2	<sup>2</sup> <b>EWP</b>	20A	Electronic Water Pump (BSA #2)
	HORN		15A	PCB Block (Horn Relay)
	EPCU1	<sup>1</sup> <b>EPCU</b>	10A	Inverter (Front)
	B/ALARM		15A	RLY.5
	IG3 8	<sup>8</sup> <b>IG3</b>	20A	PCB Block (IG3 #2 Relay)
	E-SHIFTER2	<sup>2</sup> <b>E-SHIFTER</b>	10A	SCU
	MIRR HTD		10A	Front A/C Controller, Driver/Passenger Power Outside Mirror
	P/OUTLET2	<sup>2</sup> <b>POWER OUTLET</b>	20A	Luggage Power Outlet
	P/OUTLET3	<sup>3</sup> <b>POWER OUTLET</b>	20A	Front Power Outlet



## Rear junction block

Fuse Name	Symbol	Fuse Rating	Circuit Protected
B+2	<sup>2</sup> 	30A	ICU Junction Block(IPS2, IPS5, IPS6, Fuse : F22, F29, F30, F37, F38, F46, F47)
CHILD LOCK		15A	Child Lock/Unlock Relay
P/WIN RH	<sup>RH</sup> 	30A	Passenger Safety Power Window Module (LHD), Driver Safety Power Window Module (RHD), Rear Power Window Module RH
AMP	<b>AMP</b>	25A	AMP
PRESAFETY S/ BELT1	<sup>1</sup> 	30A	Pre-Aactive Seat Belt Unit
ECS	<b>ECS</b>	15A	ECS Unit
WIPER RR		15A	Rear Wiper Relay, Rear Wiper Motor
EPCU2	<sup>2</sup> <b>EPCU</b>	10A	Inverter (Rear)
S/HTR PASS2	<sup>2</sup> <b>PASS</b> 	15A	Passenger Power Seat Module
PRESAFETY S/ BELT2	<sup>2</sup> 	30A	Pre-Aactive Seat Belt Unit
CHARGER	<b>CHARGER</b>	15A	Charging Connector Lock/Unlock Relay
S/HTR RR1	<sup>1</sup> <b>RR</b> 	20A	Rear Air Ventilation Seat Control Module, Rear Seat Warmer Control Module
PTGM		30A	Power Tailgate Module
S/HTR RR2	<sup>2</sup> <b>RR</b> 	20A	Rear Air Ventilation Seat Control Module, Rear Seat Warmer Control Module

**Tailgate fuse panel (Battery junction block)**



OJKEV091023

Inside the fuse/relay box cover, you can find the fuse/relay label describing fuse/relay names and ratings.

**i Information**

Not all fuse panel descriptions in this manual may be applicable to your vehicle; the information is accurate at the time of printing. When you inspect the fuse panel in your vehicle, refer to the fuse panel label.





91945-DS300  
 주의 CAUTION  
 91945-DS300  
 91945-DS300

此圖為預設安裝位置  
 USE THE DESIGNATED FUSE ONLY  
 USE SOLO LOS FUSIBLES ESPECIFICADOS  
 используйте только предназначенные предохранители  
 استخدم الفيوز ذو التوافق المناسب  
 请使用指定的保险丝

점프 시동 상세 방법은 차량 취급설명서를 참조하십시오.  
 For the details about jump start, refer to the owner's manual.  
 Para más información acerca de arranque con chispa de puerta consulte el manual del propietario.  
 См. руководство пользователя для дополнительной информации о запуске двигателя от внешнего источника.  
 التلمذات عن طريقة التمهيد بواسطة كلل محركه مع بطاريه خارجيه ارجع لكتاب المستخدم.  
 发动机短接起动的详细方法请参照车辆配备的车主手册相关内容。

OJKEV091029

**Battery junction block**

Fuse Name	Symbol	Fuse Rating	Circuit Protected
TRAILER		50A	Trailer Connector
B+1	<sup>1</sup> 	50A	ICU Junction Block (IPS1, IPS3, IPS4, IPS7, Short/Long Term Load Latch Relay, Fuse : F50)
B+3	<sup>3</sup> 	50A	ICU Junction Block (Fuse : F26, F33, F36, F34, F41, F42, F43, F44)
B+4	<sup>4</sup> 	50A	ICU Junction Block (Fuse : F27, F31, F45)
B+6	<sup>6</sup> 	100A	Rear Junction Block (Fuse : F3, F6, F9, F12, F14, F16, F17, F19, F20, F22, F24, F25, F26, S1)
AMS	<b>AMS</b>	10A	12V Battery Sensor

## LIGHT BULBS

We recommend that you consult an authorized retailer of Genesis Branded products to replace most vehicle light bulbs. It is difficult to replace vehicle light bulbs because other parts of the vehicle must be removed before you can get to the bulb. This is especially true for removing the headlamp assembly to get to the bulb(s).

Removing/installing the headlamp assembly can result in damage to the vehicle.



### WARNING

- Prior to working on a light, depress the foot brake, shift to P (Park), apply the parking brake, press the Start/ Stop button to the OFF position and take the key with you when leaving the vehicle to avoid sudden movement of the vehicle and to prevent possible electric shock.
- Be aware the bulbs may be hot and may burn your fingers.

### NOTICE

Be sure to replace the burned-out bulb with one of the same wattage rating. Otherwise, it may cause damage to the fuse or electrical wiring system.

### NOTICE

To prevent damage, do not clean the headlamp lens with chemical solvents or strong detergents.



### Information - Headlamp desiccant

This vehicle is equipped with desiccant to reduce fogging inside the headlamp due to moisture. The desiccant is consumable and its performance may change based on the used period or environment. If fogging inside the headlamp due to moisture continues for a long time, we recommend that you consult an authorized retailer of Genesis Branded products.



### Information

The headlamp and tail lamp lenses could appear frosty if the vehicle is washed after driving or the vehicle is driven at night in wet weather. This condition is caused by temperature difference between the lamp inside and outside and, it does not indicate a problem with your vehicle. When moisture condenses in the lamp, it will be removed after driving with the headlamp on. The removable level may differ depending on lamp size, lamp position and environmental condition. However, if moisture is not removed, we recommend that your vehicle is inspected by an authorized retailer of Genesis Branded products.

***i* Information**

- A normally functioning lamp may flicker momentarily to stabilize the vehicle's electrical control system. However, if the lamp goes out after flickering momentarily, or continues to flicker, we recommend the system be checked by an authorized retailer of Genesis Branded products.
- The position lamp may not turn on when the position lamp switch is turned on, but the position lamp and headlamp switch may turn on when the headlamp switch is turned on. This may be caused by network failure or vehicle electrical control system malfunction. If this occurs, we recommend the system be checked by an authorized retailer of Genesis Branded products.

***i* Information**

The headlamp aiming should be adjusted after an accident or after the headlamp assembly is reinstalled.

***i* Information**

**Traffic Change (for Europe)**

The low beam light distribution is asymmetric. If you go abroad to a country with opposite traffic direction, this asymmetric part will dazzle oncoming car driver. To prevent dazzle, ECE regulation demand several technical solutions (ex. automatic change system, adhesive sheet, down aiming). This headlamps are designed not to dazzle opposite drivers. So, you need not change your headlamps in a country with opposite traffic direction.

### Headlamp, position lamp, turn signal lamp, Daytime Running Light (DRL) replacement

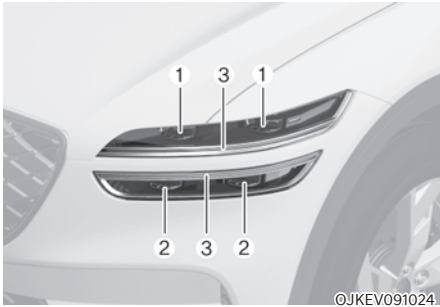

- (1) Headlamp (Low)
- (2) Headlamp (High/Sub low)
- (3) Position lamp/Daytime running light/ Turn signal lamp

If the LED lamp does not operate, we recommend that the system be inspected by an authorized retailer of Genesis Branded products.

The LED lamps cannot be replaced as a single unit because it is an integrated unit. The LED lamps has to be replaced with the unit.

A skilled technician should check or repair the LED lamp, for it may damage related parts of the vehicle.

### Headlamp aiming

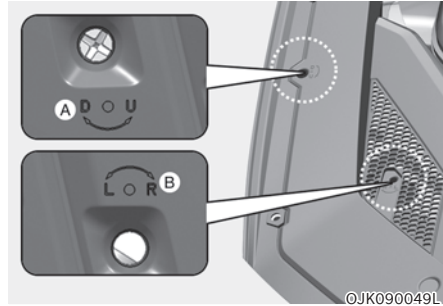

- [A]: Low beam and high beam vertical aiming
- [B]: Low beam and high beam horizontal aiming

1. Inflate the tires to the specified pressure and remove any loads from the vehicle except the driver, spare tire, and tools.
2. The vehicle should be placed on a flat floor.
3. Draw vertical lines (Vertical lines passing through respective head lamp centers) and a horizontal line (Horizontal line passing through center of head lamps) on the screen.
4. With the headlamp and battery in normal condition, aim the headlamps so the brightest portion falls on the horizontal and vertical lines.
5. To aim the low beam and high beam left or right, turn the driver clockwise or counterclockwise.  
To aim the low beam and high beam up or down, turn the driver clockwise or counterclockwise.



## Aiming point



OJKEV092043L

H1: Height between the head lamp bulb center and ground (Low beam)

H2: Height between the head lamp bulb center and ground (High beam)

W1: Distance between the two head lamp bulbs centers (Low beam)

W2: Distance between the two head lamp bulbs centers (High beam)

Vehicle condition		H1	H2	W1	W2
Without driver	mm (in)	852 (33.5)	754 (29.7)	1519 (59.8)	1519 (59.8)
	mm (in)	848 (33.4)	750 (29.5)	1519 (59.8)	1519 (59.8)

### Headlamp low beam

■ Based on 10m screen

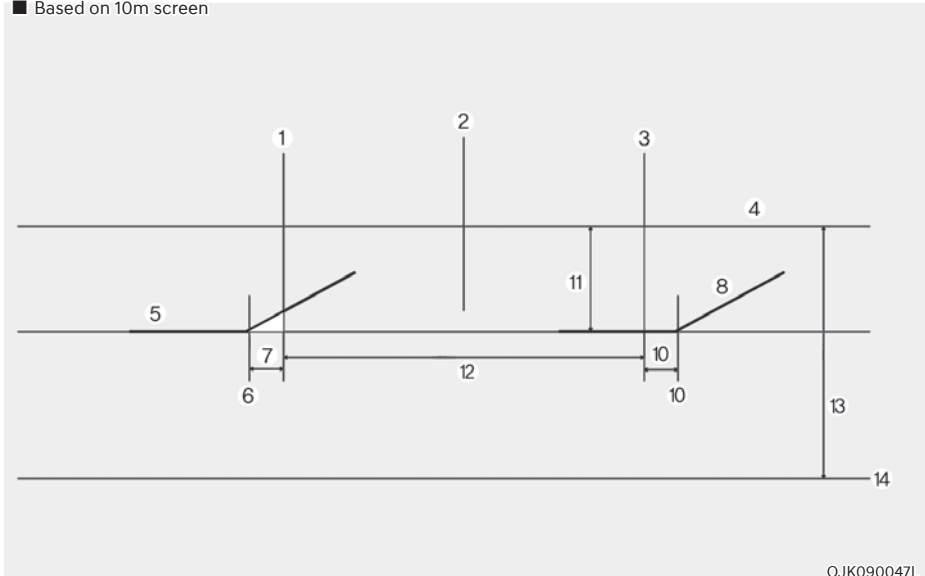

OJK090047L

- [1]: Vertical line of the left headlamp bulb center
- [2]: Car axis
- [3]: Vertical line of the right headlamp bulb center
- [4]: Horizontal line of headlamp bulb center
- [5]: cut-off line of left headlamp
- [6]: cut-off elbow of left headlamp
- [7]: distance between vertical line and cut-off elbow of left headlamp → 38mm
- [8]: cut-off line of right headlamp
- [9]: cut-off elbow of right headlamp
- [10]: distance between vertical line and cut-off elbow of right headlamp → 38mm
- [11]: 130
- [12]: W1 (Low beam)
- [13]: H1 (High beam)
- [14]: Ground

1. Turn the low beam on without driver aboard.
  2. Before aiming the car, hide the inner module of each side head lamps.
  3. The cut-off line should be projected in the cut-off line show in the picture.
  4. When aiming the low beam, vertical aiming should be adjusted after adjusting the horizontal aiming.
  5. If headlamp leveling device is equipped, adjust the headlamp leveling device switch to “o”.
- \* The high beam is aimed simultaneously when aiming the low beam.

## Puddle lamp replacement

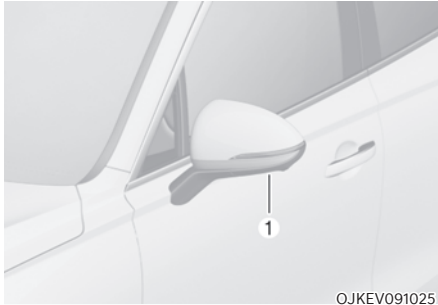

OJKEV091025

If the LED lamp (1) does not operate, we recommend that the system be inspected by an authorized retailer of Genesis Branded products.

The LED lamps cannot be replaced as a single unit because it is an integrated unit. The LED lamps has to be replaced with the unit.

A skilled technician should check or repair the LED lamp, for it may damage related parts of the vehicle.

## Rear combination lamp replacement

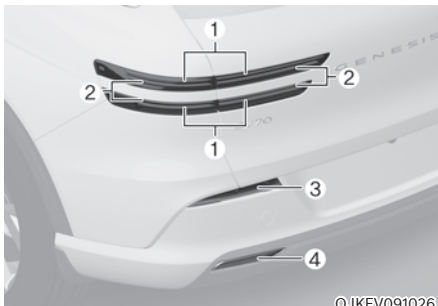

OJKEV091026

- (1) Stop lamp
- (2) Tail lamp/Stop lamp
- (3) Turn signal lamp
- (4) Reverse lamp

If the LED lamp does not operate, we recommend that the system be inspected by an authorized retailer of Genesis Branded products.

The LED lamps cannot be replaced as a single unit because it is an integrated unit. The LED lamps has to be replaced with the unit.

A skilled technician should check or repair the LED lamp, for it may damage related parts of the vehicle.

## Rear fog lamp replacement

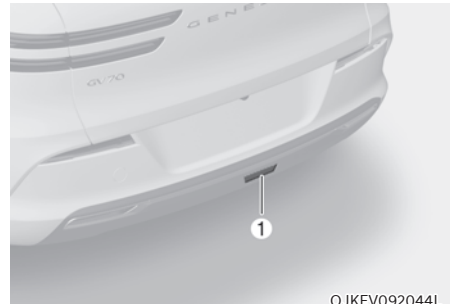

OJKEV092044L

If the LED lamp (1) does not operate, we recommend that the system be inspected by an authorized retailer of Genesis Branded products.

The LED lamps cannot be replaced as a single unit because it is an integrated unit. The LED lamps has to be replaced with the unit.

A skilled technician should check or repair the LED lamp, for it may damage related parts of the vehicle.

### High mounted stop lamp replacement

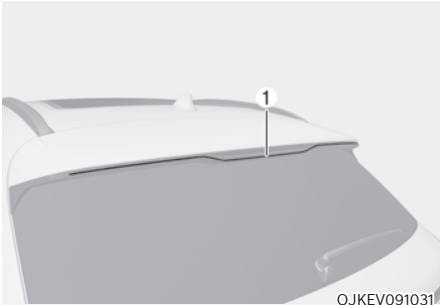

If the LED lamp (1) does not operate, we recommend that the system be inspected by an authorized retailer of Genesis Branded products.

The LED lamps cannot be replaced as a single unit because it is an integrated unit. The LED lamps has to be replaced with the unit.

A skilled technician should check or repair the LED lamp, for it may damage related parts of the vehicle.

### License plate lamp replacement

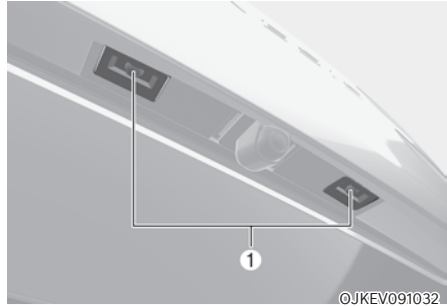

If the LED lamp (1) does not operate, we recommend that the system be inspected by an authorized retailer of Genesis Branded products.

The LED lamps cannot be replaced as a single unit because it is an integrated unit. The LED lamps has to be replaced with the unit.

A skilled technician should check or repair the LED lamp, for it may damage related parts of the vehicle.

## Front trunk lamp replacement

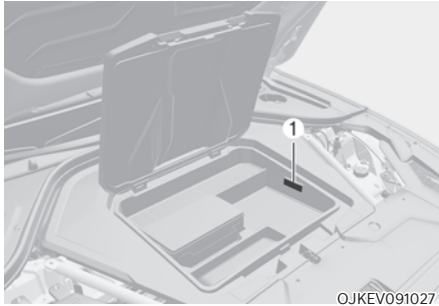

©JKEV091027

If the LED lamp (1) does not operate, we recommend that the system be inspected by an authorized retailer of Genesis Branded products.

The LED lamps cannot be replaced as a single unit because it is an integrated unit. The LED lamps has to be replaced with the unit.

A skilled technician should check or repair the LED lamp, for it may damage related parts of the vehicle.

## Interior light replacement



©JKEV091033

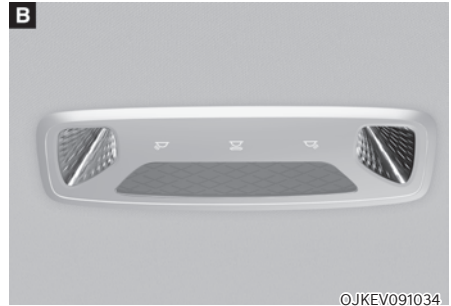

©JKEV091034



©JKEV091035

[A]: Front lamps

[B]: Rear lamps (without sunroof)

[C]: Rear lamps (with sunroof)

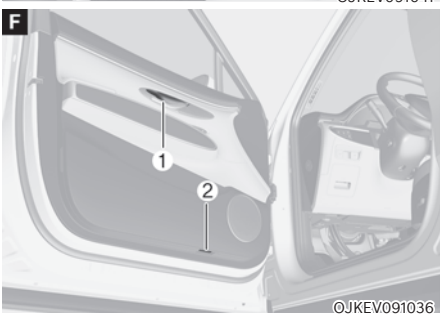
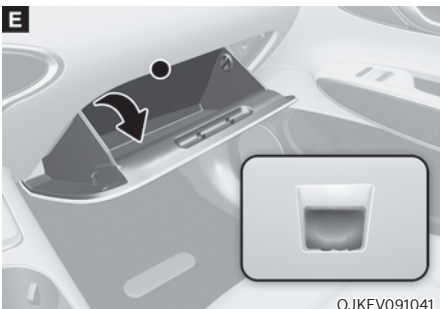
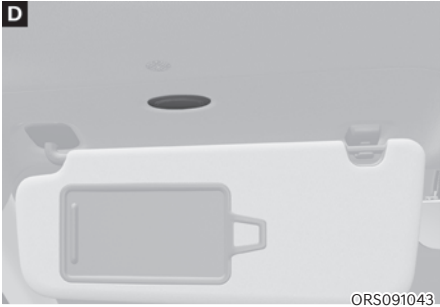

- [D]: Vanity mirror lamp
- [E]: Glove box lamp
- [F]: Inner door handle lamp / Mood lamp / Door foot lamp (if equipped)
- [G]: Tailgate lamp

If the LED lamp does not operate, we recommend that the system be inspected by an authorized retailer of Genesis Branded products.

The LED lamps cannot be replaced as a single unit because it is an integrated unit. The LED lamps has to be replaced with the unit.

A skilled technician should check or repair the LED lamp, for it may damage related parts of the vehicle.

## APPEARANCE CARE

### Exterior care

#### NOTICE

**If you park your vehicle near a stainless steel sign or glass facade building, the vehicle's exterior plastic parts such as a bumper, spoiler, garnish, lamp or outside rearview mirror might be damaged due to sunlight reflected from the sign or building. To prevent damage of the exterior plastic parts, you should avoid parking in areas where light may be reflected or use a car cover. (The exterior plastic parts applied to your vehicle may vary.)**

#### *Exterior general caution*

It is very important to follow the label directions when using any chemical cleaner or polish. Read all warning and caution statements that appear on the label.

#### *Finish maintenance*

##### **Washing**

To help protect your vehicle's finish from rust and deterioration, wash it thoroughly and frequently at least once a month with lukewarm or cold water.

If you use your vehicle for off-road driving, you should wash it after each off-road trip. Pay special attention to the removal of any accumulation of salt, dirt, mud, and other foreign materials. Make sure the drain holes in the lower edges of the doors and rocker panels are kept clear and clean.

Insects, tar, tree sap, bird droppings, industrial pollution and similar deposits can damage your vehicle's finish if not removed immediately.

Even prompt washing with plain water may not completely remove all these deposits. A mild soap, safe for use on painted surfaces, should be used.

After washing, rinse the vehicle thoroughly with lukewarm or cold water. Do not allow soap to dry on the finish.

#### **High-pressure washing**

- When using high-pressure washers, make sure to maintain sufficient distance from the vehicle. Insufficient clearance or excessive pressure can lead to component damage or water penetration.
- Do not spray the camera, sensors or its surrounding area directly with a high pressure washer. Shock applied from high pressure water may cause the device to not operate normally.
- Do not bring the nozzle tip close to boots (rubber or plastic covers) or connectors as they may be damaged if they come into contact with high pressure water.



#### **WARNING**

**After washing the vehicle, test the brakes while driving slowly to see if they have been affected by water before getting on the road. If braking performance is impaired, dry the brakes by applying them lightly while maintaining a slow forward speed.**

**NOTICE**

- Do not use strong soap, chemical detergents or hot water, and do not wash the vehicle in direct sunlight or when the body of the vehicle is warm.
- Be careful when washing the side windows of your vehicle.
- Especially, with high-pressure water, water may leak through the windows and wet the interior.
- To prevent damage to the plastic parts, do not clean with chemical solvents or strong detergents.

**NOTICE**



- Water washing in the motor compartment including high pressure water washing may cause the failure of electrical circuits located in the vehicle compartment.
- Never allow water or other liquids to come in contact with electrical/electronic components inside the vehicle as water or other liquids may flow in to the motor compartment through the front trunk and damage electrical/electronic components.

**NOTICE**

Matte paint finish vehicle (if equipped)  
Automatic car wash which uses rotating brushes should not be used as this can damage the surface of your vehicle. A steam cleaner which washes the vehicle surface at high temperature may result the oil to adhere and leave stains that is difficult to remove.

Use a soft cloth (for example, microfiber towel or sponge) when washing your vehicle and dry with a microfiber towel. When you hand wash your vehicle, you should not use a cleaner that finishes with wax. If the vehicle surface is too dirty (sand, dirt, dust, contaminant, etc.), clean the surface with water before washing the car.

**Waxing**

A good coat of wax is a barrier between your paint and contaminate. Keeping a good coat of wax on your vehicle will help protect it.

Wax the vehicle when water will no longer bead on the paint.

Always wash and dry the vehicle before waxing. Use a good quality liquid or paste wax, and follow the manufacturer's instructions. Wax all metal trim to protect it and to maintain its luster.

Removing oil, tar, and similar materials with a spot remover will usually strip the wax from the finish. Be sure to re-wax these areas even if the rest of the vehicle does not yet need waxing.



**NOTICE**

- Wiping dust or dirt off the body with a dry cloth will scratch the finish.
- Do not use steel wool, abrasive cleaners, or strong detergents containing highly alkaline or caustic agents on chrome-plated or anodized aluminum parts. This may result in damage to the protective coating and cause discoloration or paint deterioration.

**NOTICE**

**Matte paint finish vehicle (if equipped)**

Do not use any polish protector such as a detergent, an abrasive and a polish. In case wax is applied, remove the wax immediately using a silicon remover and if any tar or tar contaminant is on the surface use a tar remover to clean. However, be careful not to apply too much pressure on the painted area.

***Finish damage repair***

Deep scratches or stone chips in the painted surface must be repaired promptly. Exposed metal will quickly rust and may develop into a major repair expense.

**NOTICE**

If your vehicle is damaged and requires any metal repair or replacement, be sure the body shop applies anti-corrosion materials to the parts repaired or replaced.

**NOTICE**

**Matte paint finish vehicle (if equipped)**

In case of matte paint finish vehicles, it is impossible to modify only the damaged area and repair of the whole part is necessary. If the vehicle is damaged and painting is required, we recommend that you have your vehicle maintained and repaired by an authorized retailer of Genesis Branded products. Take extreme care, as it is difficult to restore the quality after the repair.

***Bright-metal maintenance***

- To remove road tar and insects, use a tar remover, not a scraper or other sharp object.
- To protect the surfaces of brightmetal parts from corrosion, apply a coating of wax or chrome preservative and rub to a high luster.
- During winter weather or in coastal areas, cover the bright metal parts with a heavier coating of wax or preservative. If necessary, coat the parts with non-corrosive petroleum jelly or other protective compound.

### ***Underbody maintenance***

Corrosive materials used for ice and snow removal and dust control may collect on the underbody. If these materials are not removed, accelerated rusting can occur on underbody parts such as the frame and floor pan, even though they have been treated with rust protection.

Thoroughly flush the vehicle underbody and wheel openings with lukewarm or cold water once a month, after off-road driving and at the end of each winter. Pay special attention to these areas because it is difficult to see all the mud and dirt. It will do more harm than good to wet down the road grime without removing it. The lower edges of doors, rocker panels, and frame members have drain holes that should not be allowed to clog with dirt; trapped water in these areas can cause rusting.



### **WARNING**

**After washing the vehicle, test the brakes while driving slowly to see if they have been affected by water. If braking performance is impaired, dry the brakes by applying them lightly while maintaining a slow forward speed.**

### ***Aluminum wheel maintenance***

The aluminum wheels are coated with a clear protective finish.

- Do not use abrasive cleaner, polishing compound, solvent, or wire brushes on aluminum wheels.
- Clean the wheel when it has cooled.
- Use only a mild soap or neutral detergent, and rinse thoroughly with water. Also, clean the wheels after driving on salted roads.
- Do not wash the wheels with high-speed car wash brushes.
- Do not use any cleaners containing acid or alkaline detergents.

### ***Corrosion protection***

#### **Protecting your vehicle from corrosion**

By using the most advanced design and construction practices to combat corrosion, GENESIS produces vehicles of the highest quality. However, this is only part of the job. To achieve the long-term corrosion resistance your vehicle can deliver, the owner's cooperation and assistance is also required.

#### **Common causes of corrosion**

The most common causes of corrosion on your vehicle are:

- Road salt, dirt and moisture that is allowed to accumulate underneath the vehicle.
- Removal of paint or protective coatings by stones, gravel, abrasion or minor scrapes and dents which leave unprotected metal exposed to corrosion.

### High-corrosion areas

If you live in an area where your vehicle is regularly exposed to corrosive materials, corrosion protection is particularly important. Some of the common causes of accelerated corrosion are road salts, dust control chemicals, ocean air and industrial pollution.

### Moisture breeds corrosion

Moisture creates the conditions in which corrosion is most likely to occur. For example, corrosion is accelerated by high humidity, particularly when temperatures are just above freezing. In such conditions, the corrosive material is kept in contact with the vehicle surfaces by moisture that is slow to evaporate.

Mud is particularly corrosive because it is slow to dry and holds moisture in contact with the vehicle. Although the mud appears to be dry, it can still retain moisture and promote corrosion.

High temperatures can also accelerate corrosion of parts that are not properly ventilated so the moisture can be dispersed. For all these reasons, it is particularly important to keep your vehicle clean and free of mud or accumulations of other materials. This applies not only to the visible surfaces but particularly to the underside of the vehicle.

### To help prevent corrosion

Keep your vehicle clean

The best way to prevent corrosion is to keep your vehicle clean and free of corrosive materials. Attention to the underside of the vehicle is particularly important.

- If you live in a high-corrosion area — where road salts are used, near the ocean, areas with industrial pollution, acid rain, etc., —, you should take extra care to prevent corrosion. In winter, hose off the underside of your vehicle at least once a month and be sure to clean the underside thoroughly when winter is over.
- When cleaning underneath the vehicle, pay particular attention to the components under the fenders and other areas that are hidden from view. Do a thorough job; just dampening the accumulated mud rather than washing it away will accelerate corrosion rather than prevent it. Water under high pressure and steam are particularly effective in removing accumulated mud and corrosive materials.
- When cleaning lower door panels, rocker panels and frame members, be sure that drain holes are kept open so that moisture can escape and not be trapped inside to accelerate corrosion.

### *Keep your garage dry*

Don't park your vehicle in a damp, poorly ventilated garage. This creates a favorable environment for corrosion. This is particularly true if you wash your vehicle in the garage or drive it into the garage when it is still wet or covered with snow, ice or mud. Even a heated garage can contribute to corrosion unless it is well ventilated so moisture is dispersed.

### *Keep paint and trim in good condition*

Scratches or chips in the finish should be covered with "touch-up" paint as soon as possible to reduce the possibility of corrosion. If bare metal is showing through, the attention of a qualified body and paint shop is recommended.

Bird droppings are highly corrosive and may damage painted surfaces in just a few hours. Always remove bird droppings as soon as possible.

## **Interior care**

### ***Interior general precautions***

Prevent caustic solutions such as perfume and cosmetic oil, from contacting the interior parts because they may cause damage or discoloration. If they do contact the interior parts, wipe them off immediately. See the instructions for the proper way to clean vehicle interior surfaces.

### **NOTICE**

- **Never allow water or other liquids to come in contact with electrical/electronic components inside the vehicle as this may damage them.**
- **When cleaning leather products (steering wheel, seats etc.), use neutral detergents or low alcohol content solutions. If you use high alcohol content solutions or acid/alkaline detergents, the color of the leather may fade or the surface may get stripped off.**

### ***Cleaning the upholstery and interior trim***

#### **Vehicle interior surfaces (if equipped)**

Remove dust and loose dirt from interior surfaces with a whisk broom or a vacuum cleaner.

If necessary, clean interior surfaces with a mixture of warm water and mild non-detergent cleaner (test all cleaners on a concealed area before use).

#### **Fabric (if equipped)**

Remove dust and loose dirt from fabric with a whisk broom or vacuum cleaner. Clean with a mild soap solution recommended for upholstery or carpets. Remove fresh spots immediately with a fabric spot cleaner. If fresh spots do not receive immediate attention, the fabric can be stained and its color can be affected. Also, its fire-resistant properties can be reduced if the material is not properly maintained.

**NOTICE**

**Using anything but recommended cleaners and procedures may affect the fabric's appearance and fire-resistant properties.**

**Leather (if equipped)**

- Features of seat leather
  - Leather is made from the outer skin of an animal, which goes through a special process to be available for use. Since it is a natural product, each part differs in thickness or density.  
Wrinkles may appear as a natural result of stretching and shrinking depending on the temperature and humidity.
  - The seat is made of stretchable fabric to improve comfort.
  - The parts contacting the body are curved and the side supporting area is high which provides driving comfort and stability.
  - Wrinkles may appear naturally from usage. It is not a fault of the products.

**NOTICE**

- **Wrinkles or abrasions which appear naturally from usage are not covered by warranty.**
- **Belts with metallic accessories, zippers or keys inside the back pocket may damage the seat fabric.**
- **Make sure not to wet the seat. It may change the nature of natural leather.**
- **Jeans or clothes which could bleach may contaminate the surface of the seat covering fabric.**

- Caring for the leather seats
  - Vacuum the seat periodically to remove dust and sand on the seat. It will prevent abrasion or damage of the leather and maintain its quality.
  - Wipe the natural leather seat cover often with dry or soft cloth.
  - Use of proper leather protector may prevent abrasion of the cover and helps maintain the color. Be sure to read the instructions and consult a specialist when using leather coating or protective agent.
  - Light colored (beige, cream beige) leather is easily contaminated and the stain is noticeable. Clean the seats frequently.
  - Avoid wiping with wet cloth. It may cause the surface to crack.
- Cleaning the leather seats
  - Remove all contaminations instantly. Refer to instructions below for removal of each contaminant.
  - Cosmetic products (sunscreen, foundation, etc.)  
Apply cleansing cream on a cloth and wipe the contaminated spot. Wipe off the cream with a wet cloth and remove water with a dry cloth.
  - Beverages (coffee, soft drink, etc.)  
Apply a small amount of neutral detergent and wipe until contaminations do not smear.
  - Oil  
Remove oil instantly with absorbable cloth and wipe with stain remover used only for natural leather.
  - Chewing gum  
Harden the gum with ice and remove gradually.

### ***Interior wooden trim***

- Use a wooden furniture protector (for example, wax, coating compound) to clean the interior wooden trim.
- Often wipe the interior wooden trim with a lint-free, clean cloth to maintain the unique wooden textures for a longer period of time.
- If you spill beverage (for example, water, coffee) over the interior wooden trim, immediately wipe it with clean, dry cloth.
- Sharp objects (for example, driver, knife), adhesive materials, or tapes may damage the interior wooden trim.
- Any strong impacts may damage the interior wooden trim.
- If the coating finish over the interior wooden trim is removed, moisture may damage or change wood traits.
- If the interior wooden trim is damaged, you may get a splinter from the wood surface. Therefore, you should immediately have replaced the damaged interior wooden trim. We recommend that you contact an authorized Retailer of Genesis Branded Products.
- Forged wood is an eco-friendly wooden trim made from recycled wood chips. Due to these material characteristics, the grain direction is not constant and small dots or natural cracks may occur. These are natural appearance characteristics of real wood from the manufacturing method and are not appearance defects.

### ***Cleaning the seat belt webbing***

Clean the belt webbing with any mild soap solution recommended for cleaning upholstery or carpet. Follow the instructions provided with the soap. Do not bleach or re-dye the webbing because this may weaken the seat belt.

### ***Cleaning the interior window glass***

If the interior glass surfaces of the vehicle become fogged (that is, covered with an oily, greasy or waxy film), they should be cleaned with glass cleaner. Follow the directions on the glass cleaner container.

#### **NOTICE**

**Do not scrape or scratch the inside of the rear window. This may result in damage to the rear window defroster grid.**

# Index

**A**

Accessing your vehicle.....5-5  
    Immobilizer system..... 5-11  
    Replacing the battery..... 5-10  
    Smart key precautions..... 5-9  
    Using smart key..... 5-5  
Active hood lift system.....3-71  
    System activation ..... 3-71  
    System limitation ..... 3-72  
    System malfunction..... 3-73  
Active noise control-road .....6-63  
    System malfunction..... 6-63  
Advanced Rear Occupant Alert (ROA) .....5-23  
    Declaration of Conformity ..... 5-25  
    System operation..... 5-23  
    System precautions..... 5-24  
    System setting ..... 5-23  
Air bag - supplemental restraint system .....3-51  
    Additional safety precautions..... 3-70  
    Air bag warning labels ..... 3-70  
    Do not install a Child Restraint System on the front passenger seat ..... 3-63  
    How does the air bag system operate? ..... 3-59  
    SRS care ..... 3-69  
    What to expect after an air bag inflates..... 3-62  
    Where are the air bags? ..... 3-54  
    Why didn't my air bag go off in a collision? ..... 3-64  
Air conditioner compressor label.....2-17  
Air conditioning system.....2-13  
Air ventilation seats .....3-26  
    Front air ventilation seats ..... 3-26  
All Wheel Drive (AWD).....6-51  
    All Wheel Drive (AWD) operation ..... 6-51  
    Emergency precautions ..... 6-54  
Appearance care.....9-55  
    Exterior care ..... 9-55  
    Interior care ..... 9-60



Automatic climate control system .....	5-84
Automatic temperature control mode.....	5-86
Manual temperature control mode .....	5-87
System maintenance.....	5-99
System operation.....	5-97

## **B**

Battery (12 volt).....	9-20
12V Battery recharging .....	9-22
Battery capacity label.....	9-22
Battery replacement .....	9-21
For best battery service .....	9-21
Reset items .....	9-23
Before driving.....	6-4
Before entering the vehicle .....	6-4
Before starting.....	6-4
Blind-Spot Collision-Avoidance Assist (BCA) .....	7-33
Blind-Spot Collision-Avoidance Assist malfunction and limitations .....	7-41
Blind-Spot Collision-Avoidance Assist operation .....	7-37
Blind-Spot Collision-Avoidance Assist settings .....	7-35
Blind-Spot View Monitor (BVM) .....	7-77
Blind-Spot View Monitor malfunction .....	7-78
Blind-Spot View Monitor operation.....	7-78
Blind-Spot View Monitor settings .....	7-77
Boost Mode.....	6-63
Boost Mode limitations.....	6-63
Using Boost mode.....	6-63
Brake fluid .....	9-13
Checking the brake fluid level .....	9-13
Braking system .....	6-29
Anti-lock Brake System (ABS).....	6-39
Auto Hold.....	6-35
Brake Assistant System (BAS).....	6-47
Brake Disc Cleaning .....	6-38
Disc brakes wear indicator .....	6-30
Downhill Brake Control (DBC).....	6-47
Electronic Parking Brake (EPB) .....	6-31
Electronic Stability Control (ESC).....	6-40
Emergency Stop Signal (ESS) .....	6-45

Good braking practices ..... 6-50  
High performance brake..... 6-30  
Hill-Start Assist Control (HAC)..... 6-45  
Multi-Collision Brake (MCB) ..... 6-46  
Power-assist brakes ..... 6-29  
Trailer Stability Assist (TSA)..... 6-44  
Vehicle Stability Management (VSM)..... 6-43  
Bulb wattage ..... 2-11

**C**

Cabin air filter..... 9-15  
    Filter inspection..... 9-15  
    Filter replacement..... 9-15  
Charge indicator lamp for electric vehicle..... 1-25  
    Charging status..... 1-25  
    Locking charging cable ..... 1-26  
Charge types for electric vehicle ..... 1-22  
    Charging Information..... 1-22  
    Charging time information ..... 1-22  
    Charging types ..... 1-23  
Charging the electric vehicle (abrupt stop)..... 1-51  
    Action to be taken when charging stops abruptly ..... 1-51  
Child Restraint System (CRS) ..... 3-39  
    Installing a Child Restraint System (CRS)..... 3-42  
    Our recommendation: Children always in the rear ..... 3-39  
    Selecting a Child Restraint System (CRS)..... 3-40  
Climate control additional features..... 5-104  
    Auto. Controls That Use Climate Control Settings (for driver’s seat)..... 5-106  
    Auto defogging system ..... 5-104  
    Auto dehumidify ..... 5-105  
    Recirculating air when washer fluid is used ..... 5-106  
Coolant..... 9-12

**D**

Declaration of conformity..... 2-18  
Dimensions ..... 2-10

Door locks.....	5-15
Automatic door lock and unlock features .....	5-19
Child-protector rear door locks .....	5-20
Deadlocks.....	5-19
Electronic child safety lock.....	5-20
Operating door locks from inside the vehicle .....	5-16
Operating door locks from outside the vehicle .....	5-15
Drive mode integrated control system .....	6-59
Drive modes characteristic.....	6-61
ECO, COMFORT, SPORT mode features .....	6-59
Selecting drive mode.....	6-59
Selecting multi terrain mode .....	6-62
Driver Attention Warning (DAW) .....	7-66
Driver Attention Warning malfunction and limitations.....	7-69
Driver Attention Warning operation.....	7-68
Driver Attention Warning settings.....	7-66
Driving electric vehicle.....	1-52
Aux. Battery Saver+.....	1-65
Distance to empty.....	1-54
Energy information .....	1-56
How to shut off the vehicle .....	1-53
How to start the vehicle.....	1-52
LCD display messages .....	1-60
Power/Charge Gauge .....	1-57
State of charge (SOC) gauge for high voltage battery .....	1-57
Tips for improving distance to empty .....	1-55
Virtual engine sound system .....	1-53
Warning and Indicator lights (related to electric vehicle).....	1-58

## E

Electric vehicle specifications .....	2-10
Electronically controlled suspension with road preview .....	6-57
Limitations of the system.....	6-58
System malfunction.....	6-58
Electronic control suspension .....	6-56
System malfunction.....	6-56

- EV mode ..... 1-9
  - Charging and climate ..... 1-11
  - Energy information ..... 1-10
  - EV mode screen ..... 1-9
  - EV settings ..... 1-19
  - Nearby charging stations..... 1-19
  - Next departure..... 1-10
  - Vehicle to load (V2L)..... 1-13
- Electric vehicle ..... 1-6
  - Battery Information..... 1-6
  - Characteristics of electric vehicles..... 1-6
  - Electric vehicle..... 1-6
- Emergency commodity..... 8-23
  - Fire extinguisher..... 8-23
  - First aid kit ..... 8-23
  - Tire pressure gauge ..... 8-23
  - Triangle reflector..... 8-23
- Explanation of scheduled maintenance items..... 9-11
- Exterior features..... 5-121
  - Roof side rails ..... 5-121
- Exterior features..... 5-48
  - Charging door..... 5-61
  - Front trunk..... 5-49
  - Hood..... 5-48
  - Power tailgate..... 5-51
  - Smart tailgate ..... 5-58
- Exterior lights ..... 5-64
  - Battery saver function ..... 5-67
  - Headlamp delay function ..... 5-67
  - Headlamp moisture removal function..... 5-68
  - Headlight leveling device..... 5-68
  - High beam operation..... 5-66
  - Lighting control..... 5-64
  - Rear fog lamp..... 5-67
  - Reverse guide lamp..... 5-68
  - Turn signals and lane change signals ..... 5-66
- Exterior overview (I) ..... 2-2
- Exterior overview (II)..... 2-3

## F

Fingerprint authentication system.....	5-12
Fingerprint authentication system operation.....	5-13
Fingerprint authentication system settings.....	5-12
Limitations of the system.....	5-14
When purchasing a used vehicle.....	5-14
Forward Attention Warning (FAW).....	7-72
Forward Attention Warning malfunction and limitations.....	7-74
Forward Attention Warning operation.....	7-73
Forward Attention Warning settings.....	7-72
Forward Collision-Avoidance Assist (FCA).....	7-2
Forward Collision-Avoidance Assist malfunction and limitations.....	7-18
Forward Collision-Avoidance Assist operation.....	7-9
Forward Collision-Avoidance Assist settings.....	7-6
Forward/Reverse Parking Distance Warning (PDW).....	7-143
Forward/Reverse Parking Distance Warning malfunction and limitations...	7-146
Forward/Reverse Parking Distance Warning settings.....	7-143
Parking Distance Warning operation.....	7-144
Fuses.....	9-32
Fuse/relay panel description.....	9-35
Instrument panel fuse replacement.....	9-33
Motor compartment panel fuse replacement.....	9-34

## H

Hazard warning flasher.....	8-2
Head-Up Display (HUD).....	5-62
Head-up display information.....	5-62
Head-up display settings.....	5-62
Precautions while using the head-up display.....	5-63
High Beam Assist (HBA).....	5-77
High Beam Assist malfunction and limitations.....	5-79
High Beam Assist operation.....	5-78
High Beam Assist settings.....	5-77
Highway Driving Assist (HDA).....	7-108
Highway Driving Assist malfunction and limitations.....	7-119
Highway Driving Assist operation.....	7-111
Highway Driving Assist settings.....	7-109

<b>I</b>	
If the vehicle will not start .....	8-3
If you have a flat tire (with Tire Mobility Kit) .....	8-13
Components of the Tire Mobility Kit.....	8-15
How to adjust tire pressure.....	8-19
Introduction.....	8-13
Notes on the safe use of the Tire Mobility Kit.....	8-14
Using the Tire Mobility Kit When a tire is flat.....	8-16
Important safety precautions.....	3-3
Air bag hazards .....	3-3
Always wear your seat belt .....	3-3
Control your speed .....	3-3
Driver distraction .....	3-3
Keep your vehicle in safe condition.....	3-3
Restrain all children .....	3-3
In case of an emergency while driving .....	8-2
If the vehicle stalls at a crossroad or crossing.....	8-2
If you have a flat tire while driving.....	8-3
Infotainment system.....	5-122
Antenna .....	5-122
Bluetooth® Wireless Technology.....	5-124
Infotainment system.....	5-123
Lexicon premium sound system.....	5-124
Steering wheel remote controls.....	5-122
USB Port .....	5-122
Voice recognition .....	5-123
Instrument cluster .....	4-4
Gauges and meters .....	4-6
LCD display messages .....	4-21
Warning and indicator lights .....	4-11
Instrument panel overview (I) .....	2-6
Instrument panel overview (II) .....	2-7
Instrument panel overview (III).....	2-8
Integrated memory system.....	5-26
Recalling memory positions.....	5-27
Resetting the system.....	5-27
Seat easy access.....	5-28
Storing memory positions .....	5-26

Intelligent Front-Lighting System (IFS).....	5-73
Intelligent Front-Lighting System malfunction and limitations.....	5-74
Intelligent Front-Lighting System operation.....	5-73
Intelligent Front-Lighting System settings.....	5-73
Intelligent Speed Limit Assist (ISLA).....	7-60
Intelligent Speed Limit Assist malfunction and limitations.....	7-63
Intelligent Speed Limit Assist operation.....	7-61
Intelligent Speed Limit Assist settings.....	7-60
Interior features.....	5-110
Ashtray.....	5-111
Cargo security screen.....	5-119
Clock.....	5-116
Coat hook.....	5-116
Cup holder.....	5-110
Floor mat anchor(s).....	5-116
Luggage net holder.....	5-118
Power outlet.....	5-112
Rear side window sunshades.....	5-118
Sunvisor.....	5-111
USB charger.....	5-113
Wireless smart phone charging system.....	5-114
Interior lights.....	5-69
Door handle lamp/Mood lamp/Door courtesy lamp.....	5-71
Front lamps.....	5-69
Glove box lamp.....	5-70
Interior lamp AUTO cut.....	5-69
Luggage compartment lamp.....	5-71
Puddle lamp.....	5-71
Rear lamps.....	5-70
Vanity mirror lamp.....	5-70
Welcome system.....	5-72
Interior overview (I).....	2-4
Interior overview (II).....	2-5

## J

Jump starting (12 V battery).....	8-4
-----------------------------------	-----

**L**

- Lane Following Assist (LFA) ..... 7-104
  - Lane Following Assist malfunction and limitations..... 7-107
  - Lane Following Assist operation..... 7-105
  - Lane Following Assist settings..... 7-104
- Lane Keeping Assist (LKA) ..... 7-27
  - Lane Keeping Assist malfunction and limitations ..... 7-31
  - Lane Keeping Assist operation ..... 7-28
  - Lane Keeping Assist settings ..... 7-27
- LCD display..... 4-30
  - 3D instrument cluster (for 12.3-inch 3D cluster) ..... 4-37
  - LCD display control..... 4-30
  - Option menu..... 4-35
  - View modes..... 4-30
- Light bulbs ..... 9-46
  - Front trunk lamp replacement ..... 9-53
  - Headlamp aiming ..... 9-48
  - Headlamp, position lamp, turn signal lamp, Daytime Running Light (DRL) replacement ..... 9-48
  - High mounted stop lamp replacement..... 9-52
  - Interior light replacement..... 9-53
  - License plate lamp replacement ..... 9-52
  - Puddle lamp replacement ..... 9-51
  - Rear combination lamp replacement..... 9-51
  - Rear fog lamp replacement ..... 9-51
- Load and speed capacity tires (for europe)..... 2-13

**M**

- Main components of electric vehicle..... 1-7
  - High voltage battery(lithium-ion battery) ..... 1-7
  - High voltage battery warmer system..... 1-8
  - Main components of electric vehicle ..... 1-7
- Maintenance services..... 9-4
  - Owner maintenance precautions ..... 9-4
  - Owner’s responsibility ..... 9-4
- Manual Speed Limit Assist (MSLA) ..... 7-57
  - Manual Speed Limit Assist operation ..... 7-57



Mirrors .....	5-34
Inside rearview mirror.....	5-34
Outside rearview mirrors.....	5-35
Reverse parking aid.....	5-37
Motor compartment .....	9-3
Motor compartment .....	2-9
Motor number .....	2-16

## N

Navigation-based Smart Cruise Control (NSCC).....	7-97
Limitations of Navigation-based Smart Cruise Control.....	7-100
Navigation-based Smart Cruise Control operation .....	7-98
Navigation-based Smart Cruise Control settings .....	7-97

## O

Open Source Software Notice .....	2-18
Owner maintenance .....	9-5
Owner maintenance schedule.....	9-6

## P

Pan-European eCall System .....	8-25
Information on data processing.....	8-27
Pan-European eCall System.....	8-28
Panorama sunroof .....	5-44
Automatic reversal .....	5-46
Power sunshade.....	5-44
Resetting the sunroof.....	5-47
Slide open/close .....	5-45
Sunroof open warning .....	5-48
Tilt open/close.....	5-45

## R

Rear Cross-Traffic Collision-Avoidance Assist (RCCA) .....	7-131
Rear Cross-Traffic Collision-Avoidance Assist malfunction and limitations.....	7-137
Rear Cross-Traffic Collision-Avoidance Assist operation .....	7-134
Rear Cross-Traffic Collision-Avoidance Assist settings .....	7-132

Rear View Monitor (RVM) ..... 7-121

- Rear View Monitor malfunction and limitations..... 7-125
- Rear View Monitor operation..... 7-123
- Rear View Monitor settings..... 7-121

Recommended lubricants and capacities ..... 2-14

Reduction gear ..... 6-10

- Good driving practices ..... 6-17
- LCD display messages (cluster)..... 6-15
- Reduction gear operation ..... 6-10

Reduction gear fluid ..... 9-14

Refrigerant label ..... 2-17

Regenerative braking system (Paddle shifter) ..... 6-18

- One Pedal Driving ..... 6-19
- Regenerative braking system limitations ..... 6-19
- Using i-PEDAL..... 6-21
- Using regenerative braking system ..... 6-18

Remote Smart Parking Assist (RSPA) ..... 7-158

- Detecting sensors ..... 7-159
- Front corner radar/Rear corner radar..... 7-188
- Front radar ..... 7-185
- Remote Smart Parking Assist malfunction and limitations..... 7-179
- Remote Smart Parking Assist operation..... 7-161
- Remote Smart Parking Assist settings..... 7-160

Reverse Parking Collision-Avoidance Assist (PCA) ..... 7-149

- Reverse Parking Collision-Avoidance Assist malfunction and limitations... 7-152
- Reverse Parking Collision-Avoidance Assist operation..... 7-151
- Reverse Parking Collision-Avoidance Assist settings..... 7-149

**S**

Safe Exit Assist (SEA)..... 7-51

- Safe Exit Assist malfunction and limitations ..... 7-55
- Safe Exit Assist operation ..... 7-53
- Safe Exit Assist settings ..... 7-52

Safe Exit Warning (SEW)..... 7-46

- Safe Exit Warning malfunction and limitations ..... 7-49
- Safe Exit Warning operation ..... 7-48
- Safe Exit Warning settings ..... 7-47

Safety precautions for electric vehicle.....	1-66
High voltage cut-off switch.....	1-68
If an accident occurs.....	1-66
Other precautions for electric vehicle .....	1-68
Scheduled charging.....	1-27
AC charge.....	1-32
Charging precautions .....	1-27
DC charge.....	1-36
Disconnecting charging connector in emergency .....	1-32
Electric charging label.....	1-30
Electric charging label symbol table.....	1-31
How to check the symbol on the charging label (For Europe).....	1-29
Portable charge.....	1-39
Scheduled charging .....	1-27
Scheduled maintenance services.....	9-7
Maintenance under severe usage conditions .....	9-10
Normal maintenance schedule .....	9-8
Seat belts.....	3-28
Additional seat belt safety precautions .....	3-36
Care of seat belts .....	3-38
Pre-Active Seat Belt (PSB).....	3-35
Seat belt restraint system.....	3-31
Seat belt safety precautions.....	3-28
Seat belt warning light .....	3-29
Seats.....	3-4
Front seats .....	3-8
Headrest.....	3-18
Rear seats .....	3-15
Safety precautions .....	3-7
Seat warmers.....	3-23
Front seat warmers .....	3-23
Operating rear seat warmer from front seat .....	3-24
Rear seat warmers .....	3-24
Smart Cruise Control (SCC) .....	7-79
Smart Cruise Control malfunction and limitations .....	7-91
Smart Cruise Control operation .....	7-81
Smart Cruise Control settings .....	7-80

- Smart recuperation system..... 6-22
  - Front sensors (Front radar)..... 6-24
  - Pausing smart recuperation system ..... 6-24
  - Precautions for smart recuperation system ..... 6-25
  - Smart recuperation level settings ..... 6-23
  - Smart recuperation system on/off ..... 6-22
  - Smart recuperation system operating condition..... 6-23
  - System warning due to sensor problems..... 6-25
- Special driving conditions ..... 6-64
  - Driving at night ..... 6-65
  - Driving in flooded areas..... 6-66
  - Driving in the rain ..... 6-65
  - Hazardous driving conditions ..... 6-64
  - Highway driving..... 6-66
  - Reducing the risk of a rollover..... 6-67
  - Rocking the vehicle..... 6-64
  - Smooth cornering..... 6-65
- Start/Stop button ..... 6-5
  - Remote start ..... 6-9
  - Starting the vehicle..... 6-7
  - Start/Stop button positions ..... 6-6
  - Turning off the vehicle ..... 6-8
- Steering wheel ..... 5-29
  - Heated steering wheel ..... 5-32
  - Horn..... 5-31
  - MDPS (Motor Driven Power Steering)..... 5-29
  - Tilt/Telescopic steering ..... 5-30
- Storage compartment ..... 5-108
  - Center console storage ..... 5-108
  - Glove box ..... 5-108
  - Mobile phone holder ..... 5-109
  - Sunglass holder ..... 5-109
- Surround View Monitor (SVM)..... 7-126
  - Surround View Monitor malfunction and limitations ..... 7-130
  - Surround View Monitor operation ..... 7-128
  - Surround view Monitor settings..... 7-126

## T

Theft-alarm system .....	5-22
Tire Pressure Monitoring System (TPMS) .....	8-8
Changing a tire with TPMS.....	8-11
Check tire pressure.....	8-8
Low tire pressure position and tire pressure telltale.....	8-10
Low tire pressure warning light .....	8-10
Tire pressure monitoring system.....	8-9
TPMS (Tire Pressure Monitoring System) malfunction indicator .....	8-11
Tires and wheels .....	2-12
Tires and wheels .....	9-24
Check tire inflation pressure .....	9-25
Low aspect ratio tires .....	9-31
Recommended cold tire inflation pressures .....	9-24
Tire care.....	9-24
Tire maintenance .....	9-28
Tire replacement.....	9-27
Tire rotation.....	9-26
Tire sidewall labeling.....	9-28
Tire traction.....	9-28
Wheel alignment and tire balance .....	9-26
Wheel replacement.....	9-28
Tire specification and pressure label .....	2-16
Towing .....	8-21
Removable towing hook .....	8-22
Towing service .....	8-21
Trailer towing .....	6-73
Driving with a trailer.....	6-78
If you decide to pull a trailer? .....	6-74
Maintenance when towing a trailer .....	6-81
Trailer towing equipment.....	6-77

**V**

Vehicle certification label ..... 2-15  
Vehicle Identification Number (VIN)..... 2-15  
Vehicle settings (infotainment system)..... 4-40  
    Setting your vehicle ..... 4-40  
Vehicle weight ..... 6-82  
    Overloading..... 6-82  
Vehicle weight and luggage volume ..... 2-13

**W**

Washer fluid..... 9-14  
Windows ..... 5-39  
    Power windows ..... 5-41  
Windshield defrosting and defogging..... 5-101  
    Defogging logic..... 5-102  
    Rear window defroster ..... 5-103  
    To defog inside windshield ..... 5-101  
    To defrost outside windshield ..... 5-102  
Winter driving ..... 6-68  
    Snow or icy conditions..... 6-68  
    Winter precautions ..... 6-71  
Wiper blades ..... 9-17  
    Blade inspection..... 9-17  
    Blade replacement..... 9-17  
Wipers and washers ..... 5-80  
    Front windshield washers..... 5-82  
    Front windshield wipers ..... 5-80  
    Rear window wiper and washer ..... 5-83