OWNER'S MANUAL

Operation
Maintenance
Specifications

All information in this Owner's Manual is current at the time of publication. However, Genesis Branded Vehicle reserves the right to make changes at any time so that our policy of continual product improvement may be carried out.

This manual applies to all models of this vehicle and includes descriptions and explanations of optional as well as standard equipment.

As a result, you may find material in this manual that does not apply to your specific vehicle.

Please note that some models are equipped with Right-Hand Drive (RHD). The explanations and illustrations for some operations in RHD models are opposite of those written in this manual.

CAUTION: MODIFICATIONS TO YOUR GENESIS BRANDED VEHICLE

Your Genesis Branded Vehicle should not be modified in any way. Such modifications may adversely affect the performance, safety or durability of your Genesis Branded Vehicle and may, in addition, violate conditions of the limited warranties covering the vehicle. Certain modifications may also be in violation of regulations established by the Department of Transportation and other government agencies in your country.

TWO-WAY RADIO OR CELLULAR TELEPHONE INSTALLATION

Your vehicle is equipped with electronic fuel injection and other electronic components. It is possible for an improperly installed/adjusted two-way radio or cellular telephone to adversely affect electronic systems. For this reason, we recommend that you carefully follow the radio manufacturer's instructions or consult your authorized retailer of Genesis Branded products for precautionary measures or special instructions if you choose to install one of these devices.

WARNING! (IF EQUIPPED)

The vehicle is equipped with a device of the system Pan-european eCall which calls emergency services. Any self- or unauthorized interference in the system Pan-european eCall, in vehicle systems and its components, installing of equipment which is not recommended by vehicle manufacturer and/ or in authorized retailer of Genesis Branded products can cause incorrect operation (of the device of) the system Pan-european eCall, making erroneous calls, causing failure of the device (in cars) in case of traffic accident or other accidents, when you need emergency care.

This may be dangerous and threaten your life!

SAFETY AND VEHICLE DAMAGE WARNING

This manual includes information titled as DANGER, WARNING, CAUTION and NOTICE. These titles indicate the following:

DANGER

DANGER indicates a hazardous situation which, if not avoided, will result in death or serious injury.

WARNING

WARNING indicates a hazardous situation which, if not avoided, could result in death or serious injury.

CAUTION

CAUTION indicates a hazardous situation which, if not avoided, could result in minor or moderate injury.

NOTICE

NOTICE indicates a situation which, if not avoided, could result in vehicle damage.

Table of contents

Foreword	1
Vehicle information	2
Safety system	3
Instrument cluster	4
Convenience features	5
Driving your vehicle	6
Driver assistance system	7
Emergency situations	8
Maintenance	9
Index	I

1. Foreword

Foreword	1-2
Genesis brand motor company	1-2
How to use this manual.....	1-3
Safety messages.....	1-4
Fuel requirements	1-5
Gasoline engine.....	1-5
Diesel engine	1-8
Vehicle modifications.....	1-9
Vehicle break-in process.....	1-10
Returning used vehicles (for europe).....	1-10

FOREWORD

Congratulations, and thank you for choosing Genesis Branded Vehicle. We are pleased to welcome you to the growing number of discerning people who drive Genesis Branded Vehicle. We are very proud of the advanced engineering and high-quality construction of each Genesis Branded Vehicle we build.

Your Owner's Manual will introduce you to the features and operation of your new Genesis Branded Vehicle. To become familiar with your new Genesis Branded Vehicle, so that you can fully enjoy it, read this Owner's Manual carefully before driving your new vehicle.

This manual contains important safety information and instructions intended to familiarize you with your vehicle's controls and safety features so you can safely operate your vehicle.

This manual also contains information on maintenance designed to enhance safe operation of the vehicle. It is recommended that all service and maintenance on your car be performed by an authorized retailer of Genesis Branded products. An authorized retailer of Genesis Branded products are prepared to provide high-quality service, maintenance and any other assistance that may be required.

This Owner's Manual should be considered a permanent part of your vehicle, and should be kept in the vehicle so you can refer to it at any time. The manual should stay with the vehicle if you sell it to provide the next owner with important operating, safety and maintenance information.

GENESIS BRAND MOTOR COMPANY

CAUTION

Severe engine and transmission damage may result from the use of poor quality fuels and lubricants that do not meet Genesis Branded Vehicle specifications. You must always use high quality fuels and lubricants that meet the specifications listed in the "Recommended lubricants and capacities" section of the Owner's Manual.

Copyright 2023 Genesis Brand Motor Company. All rights reserved. No part of this publication may be reproduced, stored in any retrieval system or transmitted in any form or by any means without the prior written permission of Genesis Brand Motor Company.

HOW TO USE THIS MANUAL

We want to help you get the greatest possible driving pleasure from your vehicle. Your Owner's Manual can assist you in many ways. We strongly recommend that you read the entire manual. In order to minimize the chance of death or injury, you must read the WARNING and CAUTION sections in the manual.

Illustrations complement the words in this manual to best explain how to enjoy your vehicle. By reading your manual, you will learn about features, important safety information, and driving tips under various road conditions.

The general layout of the manual is provided in the Table of Contents. Use the index when looking for a specific area or subject; it has an alphabetical listing of all information in your manual.

Sections: This manual has nine chapters plus an index. Each chapter begins with a brief list of contents so you can tell at a glance if that section has the information you want.

SAFETY MESSAGES

Your safety, and the safety of others, is very important. This Owner's Manual provides you with many safety precautions and operating procedures. This information alerts you to potential hazards that may hurt you or others, as well as damage to your vehicle.

Safety messages found on vehicle labels and in this manual describe these hazards and what to do to avoid or reduce the risks.

Warnings and instructions contained in this manual are for your safety. Failure to follow safety warnings and instructions can lead to serious injury or death.

Throughout this manual DANGER, WARNING, CAUTION, NOTICE and the SAFETY ALERT SYMBOL will be used.



This is the safety alert symbol. It is used to alert you to potential physical injury hazards. Obey all safety messages that follow this symbol to avoid possible injury or death. The safety alert symbol precedes the signal words DANGER, WARNING and CAUTION.

DANGER

DANGER indicates a hazardous situation which, if not avoided, will result in death or serious injury.

WARNING

WARNING indicates a hazardous situation which, if not avoided, could result in death or serious injury.

CAUTION

CAUTION indicates a hazardous situation which, if not avoided, could result in minor or moderate injury.

NOTICE

NOTICE indicates a situation which, if not avoided, could result in vehicle damage.

FUEL REQUIREMENTS

Gasoline engine

Unleaded

For the optimal vehicle performance, we recommend you use unleaded gasoline which has an octane rating of RON (Research Octane Number) 95/AKI (Anti Knock Index) 91 or higher. You may use unleaded gasoline with an octane rating of RON 91-94/AKI 87-90 but it may result in slight performance reduction of the vehicle. (Do not use methanol blended fuels)

Your new vehicle is designed to obtain maximum performance with UNLEADED FUEL, as well as minimize exhaust emissions and spark plug fouling.

NOTICE

NEVER USE LEADED FUEL.

The use of leaded fuel is detrimental to the catalytic converter and will damage the engine control system's oxygen sensor and affect emission control.

Never add any fuel system cleaning agents to the fuel tank other than what has been specified (We recommend that you consult an authorized retailer of Genesis Branded products for details.)

WARNING

- Do not top off after the nozzle automatically shuts off when refueling.
 - Always check that the fuel cap is installed securely to prevent fuel spillage in the event of an accident.
-

Gasoline containing alcohol and methanol

Gasohol, a mixture of gasoline and ethanol (also known as grain alcohol), and gasoline or gasohol containing methanol (also known as wood alcohol) are being marketed along with or instead of leaded or unleaded gasoline.

Do not use gasohol containing more than 10% ethanol, and do not use gasoline or gasohol containing any methanol. Either of these fuels may cause drivability problems and damage to the fuel system, engine control system and emission control system.

Discontinue using gasohol of any kind if drivability problems occur.

Vehicle damage or driveability problems may not be covered by the manufacturer's warranty if they result from the use of:

- Gasohol containing more than 10% ethanol.
- Gasoline or gasohol containing methanol.
- Leaded fuel or leaded gasohol.

NOTICE

Never use gasohol which contains methanol. Discontinue use of any gasohol product which impairs drivability.

Other fuels

Using fuel additives such as:

- Silicone fuel additive
- MMT (Manganese, Mn) fuel additive
- Ferrocene (iron-based) fuel additive
- Other metallic-based fuel additives

may result in cylinder misfire, poor acceleration, engine stalling, damage to the catalyst, or abnormal corrosion, and may cause damage to the engine resulting in a reduction in the overall life of the powertrain.

NOTICE

Damage to the fuel system or performance problem caused by the use of these fuels may not be covered by your New Vehicle Limited Warranty.

Use of MTBE

Genesis Branded Vehicle recommends avoiding fuels containing MTBE (Methyl Tertiary Butyl Ether) over 15.0% vol. (Oxygen Content 2.7% weight) in your vehicle.

Fuel containing MTBE over 15.0% vol. (Oxygen Content 2.7% weight) may reduce vehicle performance and produce vapor lock or hard starting.

NOTICE

Your New Vehicle Limited Warranty may not cover damage to the fuel system and any performance problems that are caused by the use of fuels containing methanol or fuels containing MTBE (Methyl Tertiary Butyl Ether) over 15.0% vol. (Oxygen Content 2.7% weight.)

Do not use methanol

Fuels containing methanol (wood alcohol) should not be used in your vehicle. This type of fuel can reduce vehicle performance and damage components of the fuel system, engine control system and emission control system.

Fuel Additives

Genesis Branded Vehicle recommends that you use unleaded gasoline which has an octane rating of RON (Research Octane Number) 95/AKI (Anti Knock Index) 91 or higher. For customers who do not use good quality gasolines, and have problems starting or the engine does not run smoothly, one bottle of additive added to the fuel tank is recommended according to the maintenance schedule (refer to the chapter 9, "Scheduled maintenance services").

Additives are available from your authorized retailer of Genesis Branded products along with information on how to use them. Do not mix other additives.

Operation in foreign countries

If you are going to drive your vehicle in another country, be sure to:

- Observe all regulations regarding registration and insurance.
- Determine that acceptable fuel is available.

Diesel engine

Diesel fuel

Diesel engine must be operated only on commercially available diesel fuel that complies with EN 590 or comparable standard. (EN stands for “European Norm”). Do not use marine diesel fuel, heating oils, or non-approved fuel additives, as this will increase wear and cause damage to the engine and fuel system.

The use of non-approved fuels and/or fuel additives will result in a limitation of your warranty rights.

Diesel fuel of above cetane 51 is used in your vehicle. If two types of diesel fuel are available, use summer or winter fuel properly according to the following temperature conditions.

- Above -5 °C (23 °F) ... Summer type diesel fuel.
- Below -5 °C (23 °F) ... Winter type diesel fuel.

Watch the fuel level in the tank very carefully : If the engine stops through fuel failure, the circuits must be completely purged to permit restarting.

NOTICE

Do not let any gasoline or water enter the tank. This would make it necessary to drain it out and to bleed the lines to avoid jamming the injection pump and damaging the engine.

NOTICE

Diesel Fuel (if equipped with DPF)

It is recommended to use regulated automotive diesel fuel for diesel vehicle equipped with the DPF system. If you use diesel fuel including high sulfur (more than 50 ppm sulfur) and unspecified additives, it can cause the DPF system to be damaged and white smoke can be emitted.

Biodiesel

Commercially supplied Diesel blends of no more than 7% biodiesel, commonly known as “B7 Diesel” may be used in your vehicle if Biodiesel meets EN 14214 or equivalent specifications. (EN stands for “European Norm”). The use of biofuels exceeding 7% made from rapeseed methyl ester (RME), fatty acid methyl ester (FAME), vegetable oil methyl ester (VME) etc. or mixing diesel exceeding 7% with biodiesel will cause increased wear or damage to the engine and fuel system. Repair or replacement of worn or damaged components due to the use of non approved fuels will not be covered by the manufactures warranty.

NOTICE

- Never use any fuel that fails to meet the latest petroleum industry specification.
 - Never use any fuel additives or treatments that are not recommended or approved by the vehicle manufacturer.
-

VEHICLE MODIFICATIONS

- This vehicle should not be modified. Modification of your vehicle could affect its performance, safety or durability and may even violate governmental safety and emissions regulations.

In addition, damage or performance problems resulting from any modification may not be covered under warranty.

- If you use unauthorized electronic devices, it may cause the vehicle to operate abnormally, wire damage, battery discharge and fire. For your safety, do not use unauthorized electronic devices.

NOTICE

Some warning sounds (including welcome/good-bye sound, etc.) are generated from the speakers or exterior amplifiers. If necessary, we recommend you to purchase Genesis Part to replace the speakers or exterior amplifiers. Any unauthorized product may cause a malfunction of the external amplifiers.

VEHICLE BREAK-IN PROCESS

By following a few simple precautions for the first 1,000 km (600 miles) you may add to the performance, economy and life of your vehicle.

- Do not race the engine.
- While driving, avoid sudden acceleration.
- Do not maintain a single speed for long periods of time, either fast or slow. Varying engine speed is needed to properly break-in the engine.
- Avoid hard stops, except in emergencies, to allow the brakes to seat properly.
- Fuel economy and engine performance may vary depending on vehicle break-in process and be stabilized after 6,000 km (4,000 miles). New engines may consume more oil during the vehicle break-in period.

RETURNING USED VEHICLES (FOR EUROPE)

Genesis Branded Vehicle promotes an environmentally sound treatment for end of life vehicles and offers to take back your Genesis Branded Vehicle end of life vehicles in accordance with the European Union (EU) End of Life Vehicles Directive.

You can get detailed information from your national Genesis Branded Vehicle homepage.

2. Vehicle information

Exterior overview (Front View)	2-2
Exterior overview (Rear View)	2-4
Interior overview (I)	2-6
Interior overview (II)	2-7
Center Console Overview (I)	2-8
Center Console Overview (II)	2-10
Steering Wheel Control Overview	2-12
Engine Compartment Overview	2-14
2.2 TCI	2-15
Dimensions	2-16
Engine	2-17
Bulb wattage	2-18
Tires and wheels	2-19
Load and speed capacity tires (for Europe)	2-20
Air conditioning system	2-21
Vehicle weight and luggage volume	2-22
Recommended lubricants and capacities	2-23
Recommended SAE viscosity number	2-25
Vehicle Identification Number (VIN)	2-27
Vehicle certification label	2-27
Tire specification and pressure label	2-28
Engine number	2-28
Air conditioner compressor label	2-29
Declaration of conformity	2-29
Fuel label	2-30
Gasoline engine	2-30
Diesel engine	2-31
Open Source Software Notice	2-32

Exterior overview (Front View)

Front view (Sedan)



The actual shape may differ from the illustration.

(1) Hood	5-49
(2) Headlight	5-72,9-77
(3) Side repeater light	9-81
(4) Tires and wheels	9-46
(5) Outside rearview mirror	5-36
(6) Sunroof	5-45
(7) Front windshield wiper blades	5-88,9-39
(8) Windows	5-40
(9) Front radar	7-5

Front view (Shooting Brake)



The actual shape may differ from the illustration.

(1) Hood	5-49
(2) Headlight.....	5-72,9-77
(3) Side repeater light	9-81
(4) Tires and wheels	9-46
(5) Outside rearview mirror	5-36
(6) Sunroof.....	5-45
(7) Front windshield wiper blades	5-88,9-39
(8) Windows.....	5-40
(9) Front radar	7-5

Exterior overview (Rear View)

Rear view (Sedan)

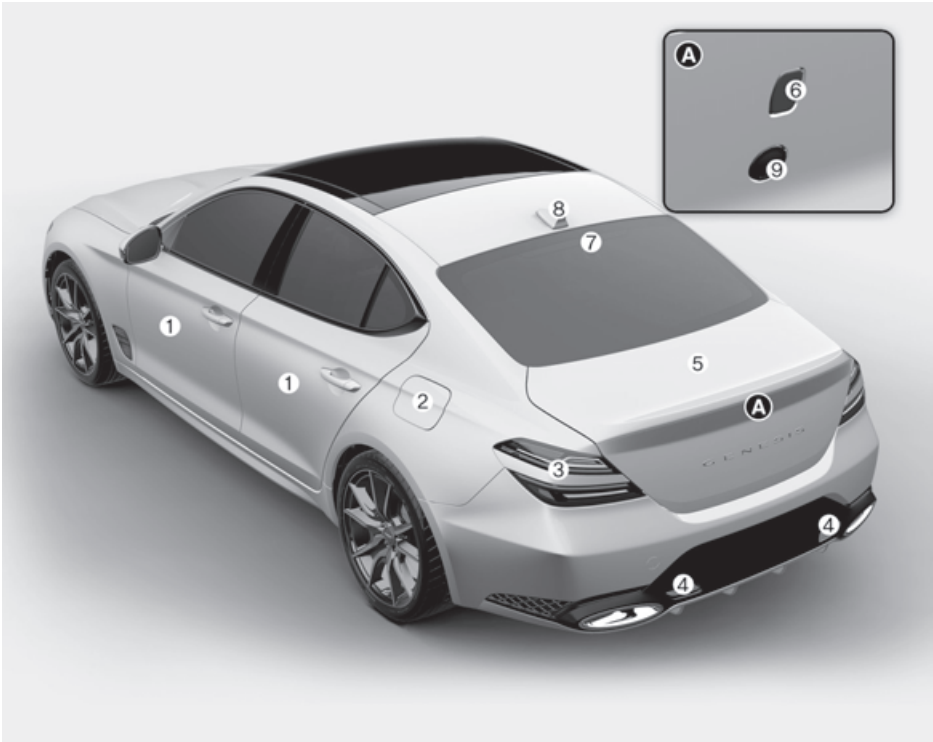

The actual shape may differ from the illustration.

(1) Door	5-13
(2) Fuel filler door	5-67
(3) Rear combination light	5-72, 9-82
(4) Backup light	5-72, 9-82
(5) Trunk	5-50
(6) Trunk open button	5-54
(7) High mounted stop light	9-83
(8) Antenna	5-129
(9) Wide-rear view camera	7-105

Rear view (Shooting Brake)



The actual shape may differ from the illustration.

(1) Door	5-13
(2) Fuel filler door	5-67
(3) Rear combination light.....	5-72, 9-82
(4) Back up light	5-72, 9-82
(5) Tailgate.....	5-57
(6) Tailgate open button	5-59
(7) Rear window wiper blades.....	5-92
(8) High mounted stop light	9-83
(9) Antenna	5-129
(10)Wide-rear view camera	7-105

Interior overview (I)

Left-hand drive

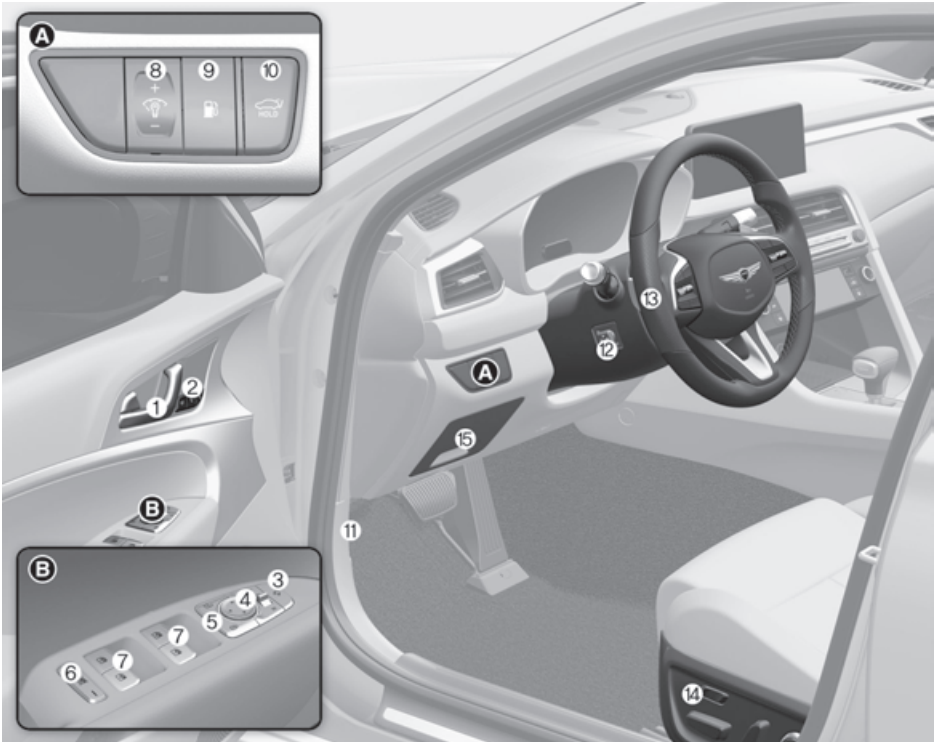

The actual shape may differ from the illustration.

(1) Inside door handle	5-14
(2) Integrated memory system	5-20
(3) Outside rearview mirror folding button	5-37
(4) Outside rearview mirror control switch	5-37
(5) Central door lock switch	5-15
(6) Power window lock button	5-43
(7) Power window switches	5-40
(8) Instrument panel illumination control switch	4-3
(9) Fuel filler door open button	5-67
(10) Trunk (or Tailgate) open/close button	5-50, 5-54, 5-59
(11) Hood release lever	5-49
(12) Steering wheel tilt/telescopic switch	5-24
(13) Steering wheel	5-23
(14) Seat adjusting switch	3-9
(15) Fuse Box	9-56

Interior overview (II)

Right-hand drive

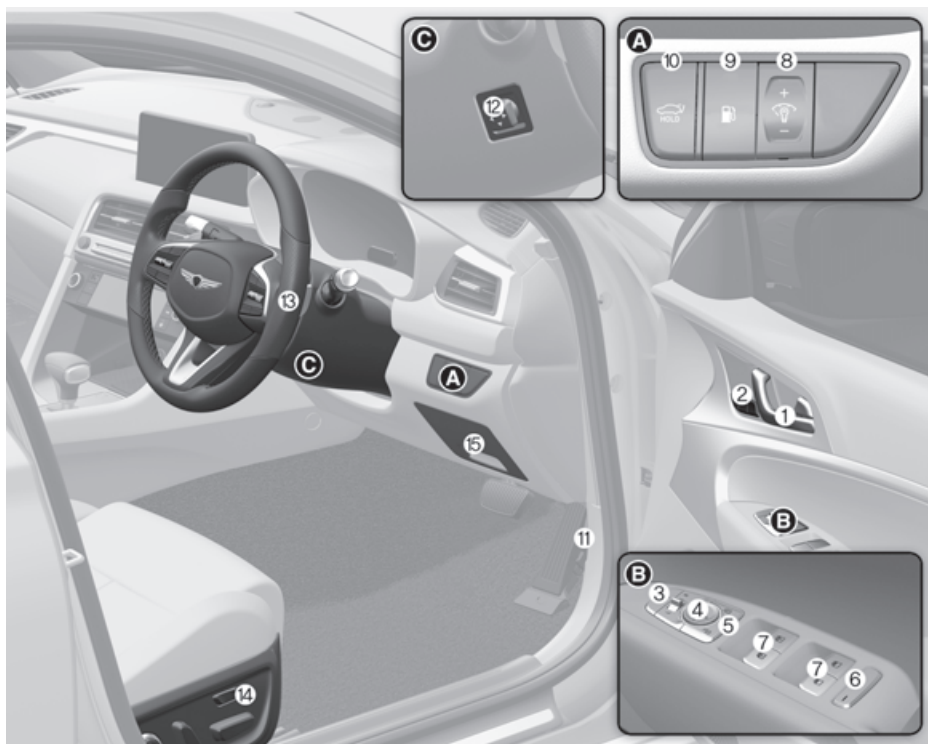

The actual shape may differ from the illustration.

(1) Inside door handle.....	5-14
(2) Integrated memory system	5-20
(3) Outside rearview mirror folding button	5-37
(4) Outside rearview mirror control switch	5-37
(5) Central door lock switch	5-15
(6) Power window lock button	5-43
(7) Power window switches	5-40
(8) Instrument panel illumination control switch	4-3
(9) Fuel filler door open button	5-67
(10)Trunk (or Tailgate) open/close button	5-50, 5-54, 5-59
(11)Hood release lever	5-49
(12)Steering wheel tilt/telescopic switch.....	5-24
(13)Steering wheel	5-23
(14)Seat adjusting switch	3-9
(15)Fuse Box	9-56

Center Console Overview (I)

Left-hand drive

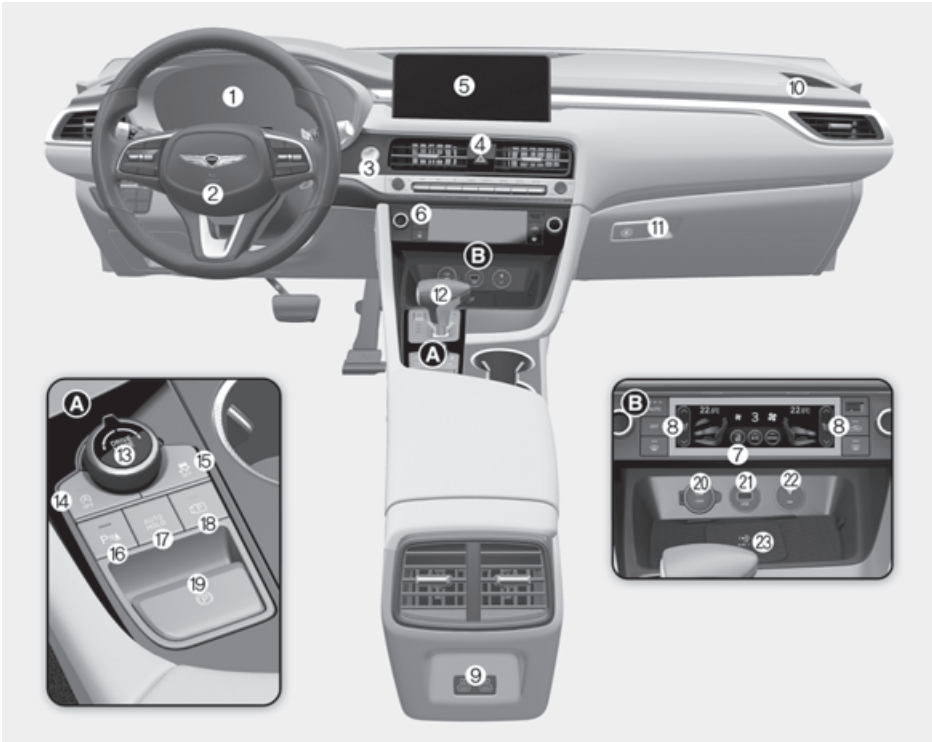

The actual shape may differ from the illustration.

(1) Instrument cluster	4-2
(2) Driver's front airbag	3-51
(3) Engine Start/Stop button	6-5
(4) Hazard warning flasher button	8-3
(5) Infotainment system	5-128
(6) Automatic climate control system	5-93
(7) Heated steering wheel button	5-26
(8) Seat warmer/Air ventilation seat button	3-20, 3-22
(9) USB charger	5-123
(10) Passenger's front airbag	3-51
(11) Glove box	5-119
(12) Transmission shift lever	6-10
(13) Drive mode integrated control	6-56
(14) ISG (Idle stop and go) OFF button	6-50
(15) ESC (Electronic Stability Control)	6-36
(16) Parking Safety button	7-133
(17) Auto Hold button	6-31
(18) Parking/View button	7-107, 7-113
(19) EPB (Electronic Parking Brake) switch	6-25

(20)Power outlet5-122
(21)USB port5-123
(22)Wireless charging system indicator5-124
(23)Wireless charging system pad5-124

Center Console Overview (II)

Right-hand drive



The actual shape may differ from the illustration.

(1) Instrument cluster	4-2
(2) Driver's front airbag	3-51
(3) Engine Start/Stop button	6-5
(4) Hazard warning flasher button	8-3
(5) Infotainment system	5-128
(6) Automatic climate control system	5-93
(7) Heated steering wheel button	5-26
(8) Seat warmer/Air ventilation seat button	3-20, 3-22
(9) USB charger	5-123
(10) Passenger's front airbag	3-51
(11) Glove box	5-119
(12) Transmission shift lever	6-10
(13) Drive mode integrated control	6-56
(14) ISG (Idle stop and go) OFF button	6-50
(15) ESC (Electronic Stability Control)	6-36
(16) Parking Safety button	7-133
(17) Auto Hold button	6-31
(18) Parking/View button	7-107, 7-113
(19) EPB (Electronic Parking Brake) switch	6-25

(20)Power outlet5-122
(21)USB port5-123
(22)Wireless charging system indicator5-124
(23)Wireless charging system pad5-124

Steering Wheel Control Overview

Left-hand drive

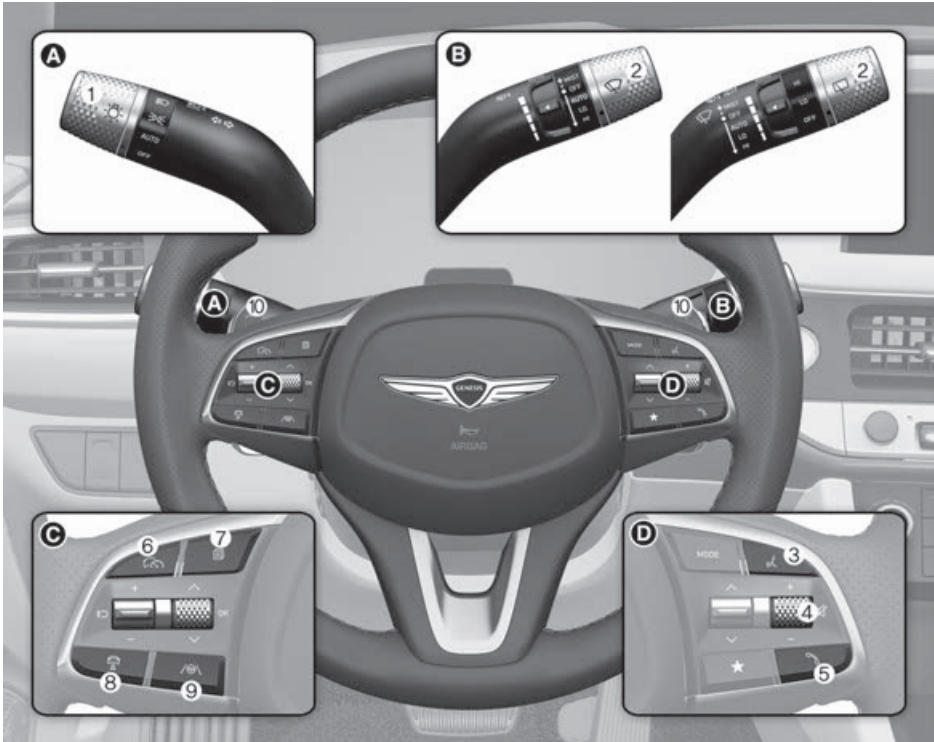

The actual shape may differ from the illustration.

(1) Lighting control lever	5-72
(2) Wiper and washer control lever.....	5-88
(3) Voice recognition button	5-131
(4) Audio Remote control button.....	5-130
(5) Bluetooth® hands-free phone button	5-131
(6) Driving Assist buttons	7-68
(7) Cluster display control buttons	4-35, 4-43
(8) Vehicle Distance button.....	7-71
(9) Lane Driving Assist button	7-25
(10)paddle shifter	6-16

Right-hand drive

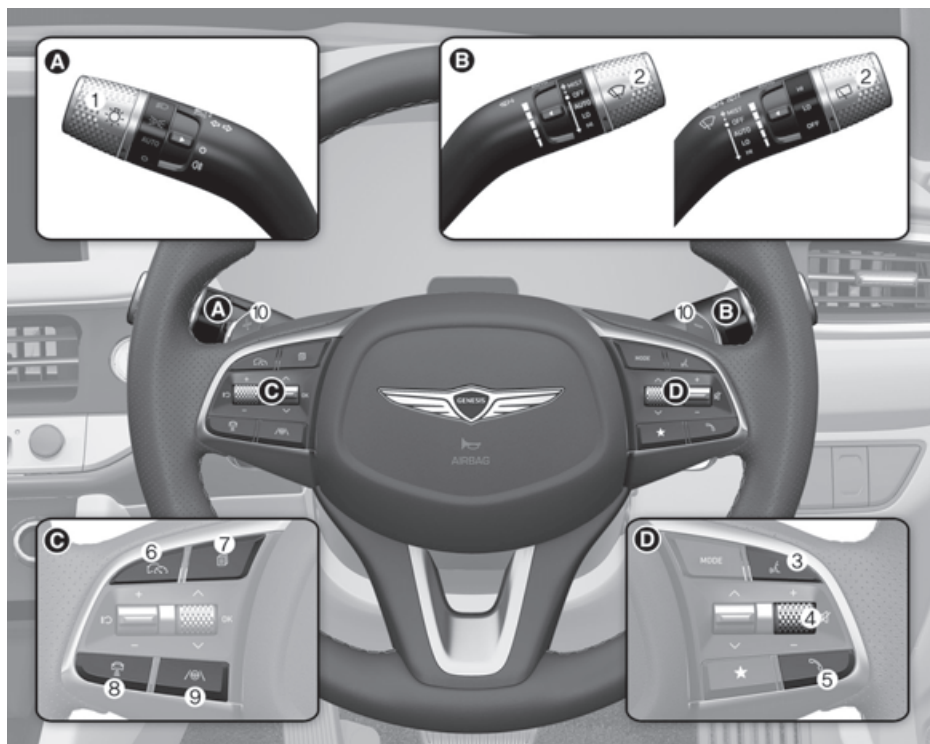

The actual shape may differ from the illustration.

(1) Lighting control lever	5-72
(2) Wiper and washer control lever.....	5-88
(3) Voice recognition button	5-131
(4) Audio Remote control button.....	5-130
(5) Bluetooth® hands-free phone button	5-131
(6) Driving Assist buttons	7-68
(7) Cluster display control buttons	4-35, 4-43
(8) Vehicle Distance button.....	7-71
(9) Lane Driving Assist button	7-25
(10)paddle shifter	6-16

Engine Compartment Overview

2.0L T-GDI

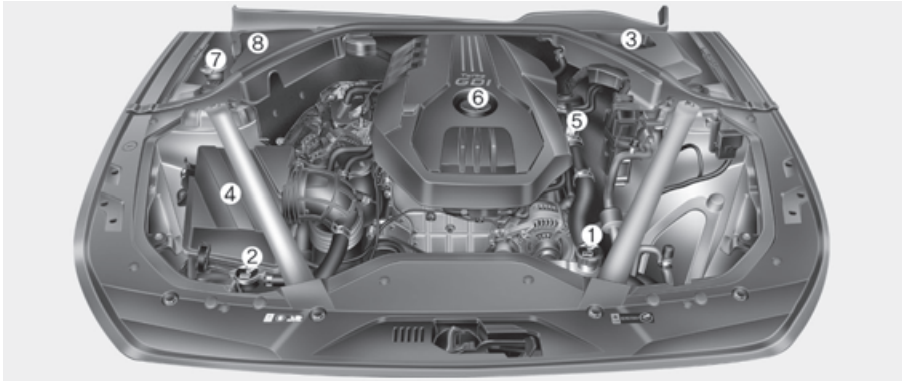

3.3L T-GDI

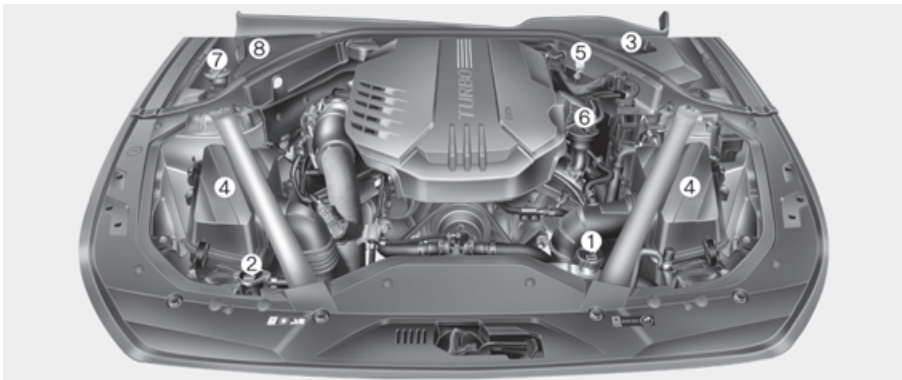

The actual engine compartment in the vehicle may differ from the illustration.

(1) Engine coolant reservoir	9-31
(2) Radiator cap	9-32
(3) Brake fluid reservoir	9-34
(4) Air cleaner	9-37
(5) Engine oil dipstick	9-27
(6) Engine oil filler cap	9-27
(7) Windshield washer fluid reservoir	9-35
(8) Fuse box	9-55

*Battery is in the trunk (or tailgate)

2.2 TCI

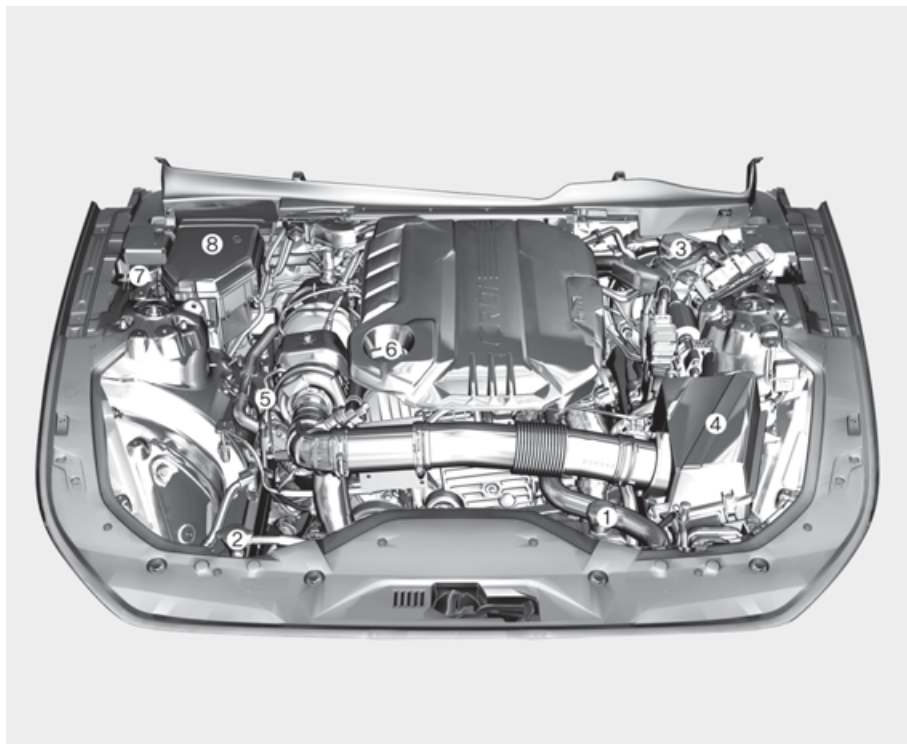

The actual engine compartment in the vehicle may differ from the illustration.

(1) Engine coolant reservoir	9-31
(2) Radiator cap	9-32
(3) Brake fluid reservoir	9-34
(4) Air cleaner	9-37
(5) Engine oil dipstick	9-27
(6) Engine oil filler cap	9-27
(7) Windshield washer fluid reservoir	9-35
(8) Fuse box	9-55

*Battery is in the trunk (or tailgate)

Dimensions

Sedan/Shooting Brake

Items		mm (in)
Overall length		4,685 (184.45)
Overall width		1,850 (72.83)
Overall height	Except Russia	1,400 (55.12)
	For Russia	1,400 (55.12)* ¹ /1,420 (55.91)
Front tread	225/45 R18	1,596 (62.83)
	225/40 R19	1,596 (62.83)
Rear tread	225/45 R18	1,632 (64.25)
	255/35 R19	1,604 (63.15)
Wheelbase		2,835 (111.61)

*1 If equipped with ECS. (Electronic Control Suspension).

Engine

Engine	Displacement cc (cu. in)	Bore x Stroke mm (in.)	Firing order	No. of cylinders
2.0L T-GDI	1,998 (121.9)	86 x 86 (3.39 x 3.39)	1-3-4-2	4
3.3L T-GDI	3,342 (203.94)	92 x 83.8 (3.78 x 3.299)	1-2-3-4-5-6	6
2.2L TCI	2,199 (134.19)	85.4 x 96 (3.4 x 3.8)	1-3-4-2	4

Bulb wattage

Light bulb		Bulb type	Wattage
Front	Headlight	Low	LED
		High	LED
	Turn signal light		LED
	Position light		LED
	Daytime Running light (DRL)		LED
	Puddle light		LED
Rear	Stop light		LED
	Tail light		LED
	Turn signal light		LED
	Backup light		LED
	License plate light		LED
	Fog light(if equipped)		LED
	High mounted stop light		LED
Interior	Map light		LED
	Room lamp		LED
	Vanity mirror lamp		LED
	Glove box lamp		LED
	Mood lamp/Foot lamp		LED
	Trunk (or tailgate) lamp		LED

Tires and wheels

Items	Tire size	Wheel size	Inflation pressure kPa (psi)				Wheel nut torque [kgf·m (lbf·ft, N·m)]
			Normal load		Maximum load		
			Front	Rear	Front	Rear	
Full size tire	225/45 R18	8.0J X 18	250 (36)	270 (39)	260 (38)	270 (39)	11-13 (79-94, 107-127)
	225/40 R19	8.0J X 19	250 (36)	-	260 (38)	-	
	255/35 R19	8.5J X 19	-	250 (36) 260 (38) ^{*1}	-	270 (39)	
Compact spare tire ^{*2}	T135/80 R18	4.0T X 18	420 (60)	420 (60)	420 (60)	420 (60)	

*1 For only 2.2L TCI and Shooting brake

*2 If your vehicle is not equipped with a compact spare tire, a Tire Mobility Kit will be provided with your vehicle.

NOTICE

- Ambient temperature affects tire pressure (about 7 kPa (1 psi) for every 7°C (12°F) change). If colder temperatures are anticipated, it is permissible to increase cold tire inflation pressure by up to 20 kPa (3 psi) over the specification. If extreme temperature changes are expected, be sure to check and adjust tire pressure accordingly.
- Tire inflation pressure decreases with higher elevation, and increases with lower elevation (about 10 kPa (2.4 psi) for every kilometer (or mile) elevation change). Be sure to check and adjust tire pressure accordingly when driving through changing elevations.
- Do not exceed the maximum inflation pressure, as found on the sidewall of the tire(s).

CAUTION

When replacing tires, Always use the same size, type, brand, construction and tread pattern supplied with the vehicle. If not, it can damage the related parts or make it work irregularly.

Load and speed capacity tires (for Europe)

Items	Tire size	Wheel size	Load capacity		Speed capacity	
			LI *1	kg	SS *2	km/h
Full size tire	225/45 R18	8.0J X 18	95	690	Y	300
	225/40 R19	8.0J X 19	93	650	Y	300
	255/35 R19	8.5J X 19	96	710	Y	300
Compact spare tire	T135/80 R18	4.0T X 18	104	900	M	130

*1 LI : LOAD INDEX

*2 SS : SPEED SYMBOL

Air conditioning system

	Item	Weight of volume	Classification
Refrigerant	Type A	570±25 g (20.12±0.88 oz.)	R-1234yf
	Type B	600±25 g (20.16±0.88 oz.)	R-134a
Compressor lubricant		100±10 g (3.52±0.35 oz.)	PAG

We recommend that you contact an authorized retailer of Genesis Branded products dealer for more information.

Vehicle weight and luggage volume

Sedan

Item	Except Middle East, Europe, Russia		For Middle East			
	3.3L T-GDI		2.0L T-GDI		3.3L T-GDI	
	2WD	AWD	2WD	AWD	2WD	AWD
Gross vehicle weight	2,180 kg (4,806 lbs.)	2,245 kg (4,949 lbs.)	2,110 kg (4,652 lbs.)	2,175 kg (4,795 lbs.)	2,180 kg (4,806 lbs.)	2,245 kg (4,949 lbs.)

Item	For Europe				For Russia			
	2.0L T-GDI		2.2L TCI		2.0L T-GDI		3.3L T-GDI	
	2WD	AWD	2WD	AWD	2WD	AWD	2WD	AWD
Gross vehicle weight	2,140 kg (4,717 lbs.)	2,200 kg (4,850 lbs.)	2,240 kg (4,938 lbs.)	2,300 kg (5,070 lbs.)	2,140 kg (4,717 lbs.)	2,200 kg (4,850 lbs.)	2,180 kg (4,806 lbs.)	2,245 kg (4,949 lbs.)

Luggage volume

330 ℓ (11.7 cu. ft)

Shooting Brake

Item	For Europe				For Russia	
	2.0L T-GDI		2.2L TCI		2.0L T-GDI	
	2WD	AWD	2WD	AWD	2WD	AWD
Gross vehicle weight	2,175 kg (4,795 lbs.)	2,235 kg (4,927 lbs.)	2,275 kg (4,949 lbs.)	2,335 kg (5,147 lbs.)	2,175 kg (4,795 lbs.)	2,235 kg (4,927 lbs.)

Luggage volume

465 ℓ (16.4 cu ft)

Recommended lubricants and capacities

To help achieve proper engine and powertrain performance and durability, use only lubricants of the proper quality. The correct lubricants also help promote engine efficiency that results in improved fuel economy.

These lubricants and fluids are recommended for use in your vehicle.

Lubricant		Volume	Classification
Engine oil ^{*1*2} Recommends	2.0L T-GDI	5.7 ℓ (6.02 US qt.)	API SN PLUS/SP or ILSAC GF-6 ³ SAE: 0W-30
	3.3L T-GDI	6.91 ℓ (7.3 US qt.)	ACEA A5/B5 ⁴ SAE: 5W-30
	 2.2L TCI	2WD	6.3 ℓ (6.66 US qt.)
AWD		For Europe (except Russia): 6.3 ℓ (6.66 US qt.) Except Europe: 6.8 ℓ (7.19 US qt.)	
Urea solution (Diesel engine)		18 ℓ (19 US qt.)	ISO 22241 or DIN 70070
Automatic transmission fluid		9.2 ℓ (9.7 US qt.)	GS ATF SP-IV-RR, Genesis/HYUNDAI genuine ATF SP-IV-RR
Engine coolant	2.0L T-GDI	7.27 ℓ (7.68 US qt.)	Mixture of antifreeze and water (Phosphate-based Ethylene glycol coolant for aluminum radiator)
	3.3L T-GDI	10.5 ℓ (11.1 US qt.)	
	2.2L TCI	9.82 ℓ (10.37 qt.)	
Brake fluid ^{*5}		As required	SAE J1704 DOT-4 LV, FMVSS 116 DOT-4, ISO4925 CLASS-6

Lubricant		Volume	Classification
Front differential oil (AWD) *6		0.7 ℓ (0.74 US qt.)	HYPOID GEAR OIL API GL-5 SAE 75W85 (SK HK SYN GEAR OIL 75W85 OR EQUIVALENT)
Rear differential oil *6 (without LSD)	2.0L T-GDI	1.2 ℓ (1.26 US qt.)	HYPOID GEAR OIL API GL-5 SAE 75W/85 (SK HK SYN GEAR OIL 75W85)
	3.3L T-GDI	1.3 ℓ (1.37 US qt.)	
	2.2L TCI	1.2 ℓ (1.27 US qt.)	
Rear differential oil *6*7 (with LSD)	2.0L T-GDI	1.3 ℓ (1.37 US qt.)	HYPOID GEAR OIL API GL-5 SAE 75W85 (SK HK JL SYN LSD GEAR OIL 75W85 PLUS OR SK HK SYN GEAR OIL 75W85 FM PLUS)
	3.3L T-GDI	1.4 ℓ (1.47 US qt.)	
	2.2L TCI	1.3 ℓ (1.37 US qt.)	
Transfer case oil (AWD)	Gear/Clutch	0.57 ℓ (0.60 US qt.)	SHELL TF 0870B
	Actuator	0.25 ℓ (0.26 US qt.)	
Fuel		60 ℓ (15.8 US gal.)	Refer to the "Fuel requirements" in chapter 1.

*1 Refer to the "Recommended SAE viscosity number" section.

*2 If the above recommended specification oil is not available, SAE 0W-30 grade synthetic oil can be used. If mineral oil or semi-synthetic oil is used, it is a severe maintenance condition in terms of engine oil change.

*3 Requires <API SN PLUS (or above) Full synthetic> grade engine oil. If a lower grade engine oil (mineral oil including Semi-synthetic) is used, then the engine oil and engine oil filter must be replaced as indicated severe maintenance condition.

*4 Requires <API Latest (or ILSAC Latest) or ACEA A5/B5 Full synthetic> grade engine oil. If a lower grade engine oil (mineral oil including Semi-synthetic) is used. Then the engine oil and engine oil filter must be replaced as indicated severe maintenance condition.

*5 To maintain the best braking performance and ABS/ESC performance, we recommend that you use genuine brake fluid that conform to specifications.

*6 If the front/rear differential is submerged, we recommend that you visit an authorized retailer of Genesis Branded products to immediately replace the differential oil.

*7 Be sure to inject oil for exclusive use of LSD when replacing Rear Differential Oil (if equipped with Limited Slip Differential).

Recommended SAE viscosity number

NOTICE

- Always be sure to clean the area around any filler plug, drain plug, or dipstick before checking or draining any lubricant. This is especially important in dusty or sandy areas and when the vehicle is used on unpaved roads. Cleaning the plug and dipstick areas will prevent dirt and grit from entering the engine and other mechanisms that could be damaged.
- Never add any additives to the engine oil. Engine oil additives can change the properties of engine oil and may cause serious engine failure.

Engine oil viscosity (thickness) has an effect on fuel economy and cold weather operating (engine start and engine oil flowability). Lower viscosity engine oils can provide better fuel economy and cold weather performance, however, higher viscosity engine oils are required for satisfactory lubrication in hot weather. Using oils of any viscosity other than those recommended could result in engine damage.

When choosing an oil, consider the range of temperature your vehicle will be operated in before the next oil change. Proceed to select the recommended oil viscosity from the chart.

		Temperature Range for SAE Viscosity Numbers								
Temperature	°C	-30	-20	-10	0	10	20	30	40	50
	(°F)	-10	0	20	40	60	80	100	120	
2.0L T-GDI*1		0W-30								
3.3L T-GDI*2					20W-50					
				15W-40						
			10W-30							
		5W-30, 5W-40								
2.2L TCI		5W-30								
		0W-30								

*1 Requires <API SN PLUS (or above) Full synthetic> grade engine oil. If a lower grade engine oil (mineral oil including Semi-synthetic) is used, then the engine oil and engine oil filter must be replaced as indicated severe maintenance condition.

*2 For better fuel economy, it is recommended to use the engine oil of a viscosity grade SAE 5W-30. However, if the engine oil is not available in your country, select the proper engine oil using the engine oil viscosity chart.



An engine oil displaying this American Petroleum Institute (API) Certification Mark conforms to the International Lubricant Specification Advisory Committee (ILSAC). It is recommended to only use engine oils that uphold this API Certification Mark.

Vehicle Identification Number (VIN)

Frame number

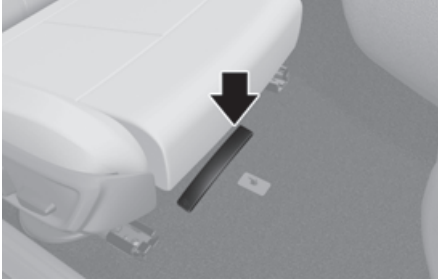

The vehicle identification number (VIN) is the number used in registering your vehicle and in all legal matters pertaining to its ownership, etc.

The number is punched on the floor under the right front seat. To check the number, open the cover.

VIN label (if equipped)



The VIN is also on a plate attached to the top of the left side dashboard. The number on the plate can easily be seen through the windshield from outside.

Vehicle certification label



The vehicle certification label attached on the driver's (or front passenger's) side center pillar gives the vehicle identification number (VIN).

Tire specification and pressure label

Left-hand drive



Right-hand drive



The tires supplied on your new vehicle are chosen to provide the best performance for normal driving.

The tire label located on the driver's side center pillar gives the tire pressures recommended for your vehicle.

Engine number

2.0L T-GDI

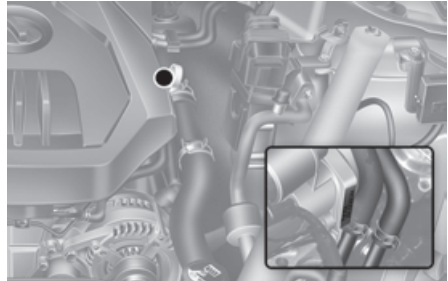

3.3L T-GDI

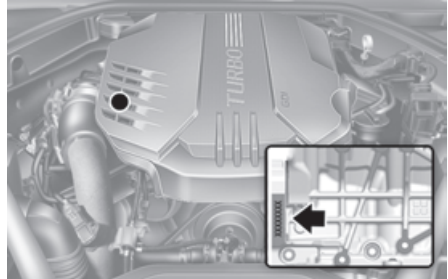

2.2L TCI

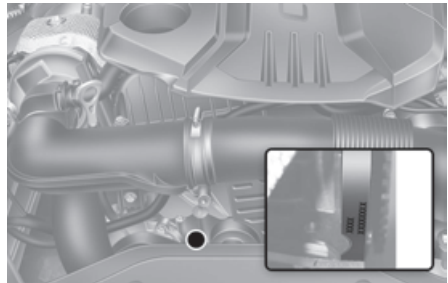

The engine number is stamped on the engine block as shown in the drawing.

Air conditioner compressor label



A compressor label informs you the type of compressor your vehicle is equipped with such as model, supplier part number, production number, refrigerant (1) and refrigerant oil (2).

Declaration of conformity

 if equipped

Example



The radio frequency components of the vehicle comply with requirements and other relevant provisions of Directive 1995/5/EC.

Further information including the manufacturer's declaration of conformity is available on Genesis Branded Vehicle web site as follows;

<http://service.hyundai-motor.com>

Fuel label

 if equipped

Gasoline engine

The fuel label is attached on the fuel filler door.

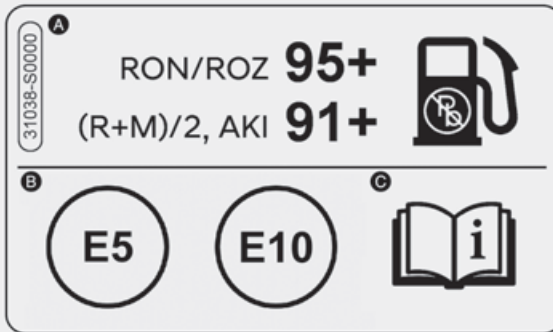

A. Octane rating of unleaded gasoline

1. RON/ROZ : Research Octane Number

2. (R+M)/2, AKI : Anti Knock Index

B. Identifiers for Petrol-type fuels

* This symbol means usable fuel. Do not use any other fuel.

C. For more information, refer to the “Fuel requirements” section in the chapter 1.

Diesel engine

The fuel label is attached on the fuel filler door.



A. Fuel : Diesel

B. Identifiers for FAME containing Diesel-type fuels

* This symbol means usable fuel. Do not use any other fuel.

C. For more information, refer to the “Diesel engine” section in the chapter 1.

Open Source Software Notice

This vehicle contains software with open source licenses.

Open source software information including the source code, copyright notices and referred license terms may be obtained on the website

<https://www.genesis.com/worldwide/en/opensource.html>

Hyundai Motor Company will provide the open source code to you in storage medium such as CD-ROM for minimum charge covering the cost of performing source distribution upon email request to opensource@genesis.com within a period of 3 years from the date of product purchase.

3. Safety system

- Important safety precautions 3-3
 - Always wear your seat belt..... 3-3
 - Restrain all children 3-3
 - Airbag hazards..... 3-3
 - Driver distraction 3-3
 - Never drink or take drugs and drive 3-3
 - Control your speed 3-4
 - Keep your vehicle in safe condition..... 3-4
- Seats 3-5
- Left-hand drive 3-5
- Right-hand drive..... 3-6
 - Safety precautions 3-8
 - Front seats 3-9
 - Rear seats 3-13
 - Headrest 3-16
 - Seat warmers 3-20
 - Air ventilation seats 3-22
- Seat belts..... 3-24
 - Seat belt safety precautions 3-24
 - Seat belt warning light..... 3-25
 - Seat belt restraint system..... 3-27
 - Additional seat belt safety precautions..... 3-31
 - Care of seat belts 3-33
- Child Restraint System (CRS) 3-33
 - Our recommendation: Children always in the rear 3-33
 - Selecting a Child Restraint System (CRS) 3-34
 - Installing a Child Restraint System (CRS) 3-36
- Airbag - supplemental restraint system..... 3-48
 - Where are the airbags?..... 3-51
 - How does the airbags system operate? 3-56
 - What to expect after an airbag inflates 3-59
 - Why didn't my airbag go off in a collision? 3-60
 - SRS care..... 3-65
 - Additional safety precautions 3-66
 - Airbag warning labels 3-66
- Active hood lift system..... 3-67

System activation	3-67
System limitation.....	3-68
System malfunction	3-69

Important safety precautions

You will find many safety precautions and recommendations throughout this section, and throughout this manual. The safety precautions in this section are among the most important.

Always wear your seat belt

A seat belt is your best protection in all types of accidents. Airbags are designed to supplement seat belts, not to replace them. So even though your vehicle is equipped with airbags, always make sure you and your passengers wear your seat belts, and wear them properly.

Restrain all children

All children under age 13 should ride in your vehicle properly restrained in a rear seat, not the front seat. Infants and small children should be restrained in an appropriate Child Restraint System. Larger children should use a booster seat with the lap/shoulder belt until they can use the seat belt properly without a booster seat.

Airbag hazards

While airbags can save lives, they can also cause serious or fatal injuries to occupants who sit too close to them, or who are not properly restrained. Infants, young children, and short adults are at the greatest risk of being injured by an inflating airbag. Follow all instructions and warnings in this manual.

Driver distraction

Driver distraction presents a serious and potentially deadly danger, especially for inexperienced drivers. Safety should be the primary concern when behind the wheel and drivers need to be aware of the wide array of potential distractions, such as drowsiness, reaching for objects, eating, personal grooming, other passengers, and using mobile phones.

Drivers can become distracted when they take their eyes and attention off the road or their hands off the wheel to focus on activities other than driving. To reduce your risk of distraction and an accident:

- Set up your mobile devices (I.e. MP3 players, phones, navigation units, etc.) **ONLY** when your vehicle is parked or safely stopped.
- **ONLY** use your mobile device when allowed by laws and conditions permit safe use. Never text or email while driving. Most countries have laws prohibiting drivers from texting. Some countries and cities also prohibit drivers from using handheld phones.
- Never let the use of a mobile device distract you from driving. You have a responsibility to your passengers and others on the road to always drive safely, with your hands on the wheel as well as your eyes and attention on the road.

Never drink or take drugs and drive

Drinking alcohol or taking drugs can reduce your ability to respond to changing conditions and emergencies. Do not drink or take drugs and drive, and do not let your friends drink or take drugs and drive.

Control your speed

Excessive speed is a major factor in crash injuries and deaths. Generally, the higher the speed, the greater the risk, but serious injuries can also occur at lower speeds. Never drive faster than is safe for current conditions, regardless of the maximum speed posted.

Keep your vehicle in safe condition

Having a tire blowout or a mechanical failure can be extremely hazardous. To reduce the possibility of such problems, check your tire pressures and condition frequently, and perform all regularly scheduled maintenance.

Seats

Left-hand drive

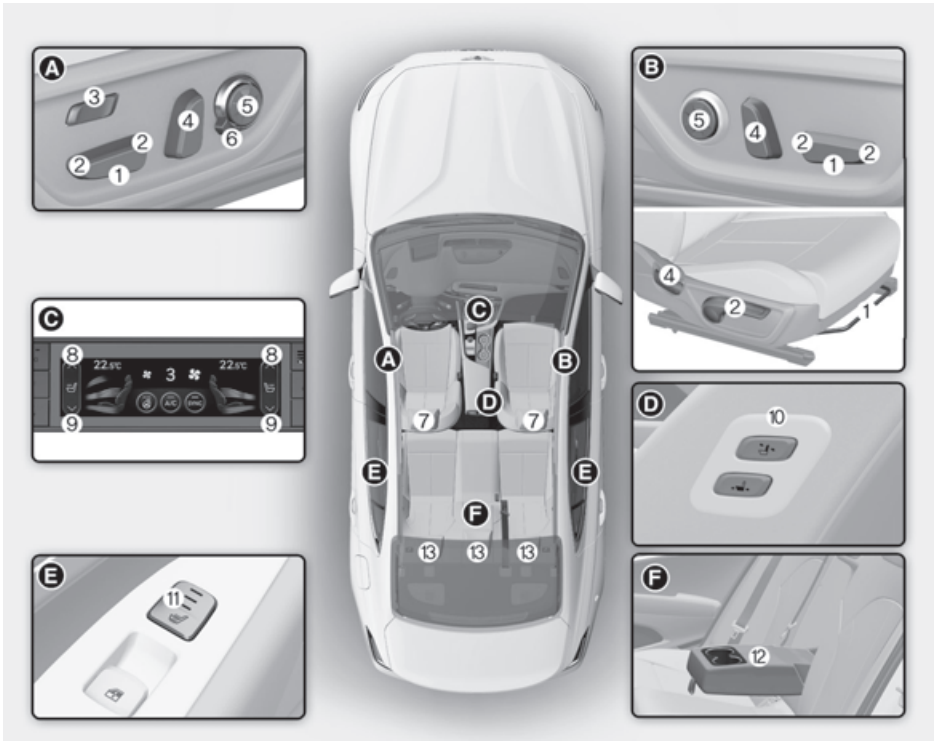

The actual shape may differ from the illustration.

- (1) Forward and backward
- (2) Seat cushion angle/height
- (3) Cushion extension
- (4) Seatback angle
- (5) Lumbar support
- (6) Seat back bolster
- (7) Front headrest
- (8) Front seat warmer
- (9) Front air ventilation seat
- (10) Walk-in switch (passenger's side)
- (11) Rear seat warmer
- (12) Armrest
- (13) Rear headrest

Right-hand drive

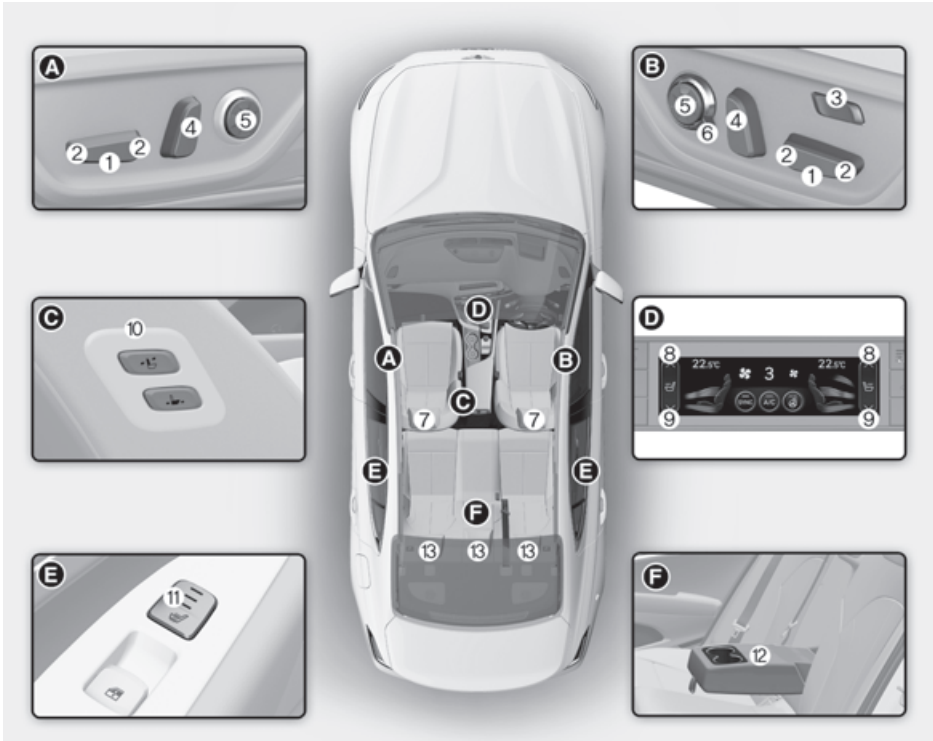

The actual shape may differ from the illustration.

- (1) Forward and backward
- (2) Seat cushion angle/height
- (3) Cushion extension
- (4) Seatback angle
- (5) Lumbar support
- (6) Seat back bolster
- (7) Front headrest
- (8) Front seat warmer
- (9) Front air ventilation seat
- (10) Walk-in switch (passenger's side)
- (11) Rear seat warmer
- (12) Armrest
- (13) Rear headrest

Infotainment system

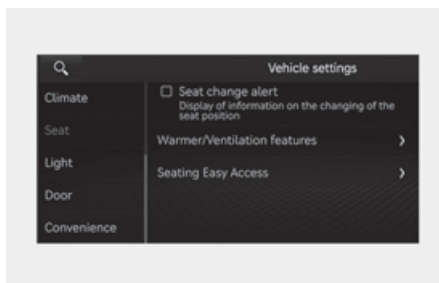

Select **Setup (Settings) > Vehicle > Seat** from the Settings menu in the infotainment system, you may use various convenience functions.

- **Seat change alert:** Detailed information of the seat switch and image appear when the driver's seat position moves.
- **Warmer/Ventilation features**
 - **Warmer/ventilation based on climate settings:** The seat temperature is automatically controlled.
- **Seating Easy Access**
 - **Easy steering access:** Moves the steering wheel when the driver enters or leaves the vehicle.
 - **Easy seat access:** The distance (Normal/Extended/Off) the seat automatically moves when the driver enters or leaves the vehicle may be selected.

i Information

- The infotainment system may change after software updates. For more information, refer to the manual provided in the infotainment system and the quick reference guide.
- The information provided may differ depending on which functions are available on your vehicle.

Safety precautions

Adjusting the seats so that you are sitting in a safe and comfortable position plays an important role for the safety of the driver and passengers, as much as seat belts and airbags when in an accident.

WARNING

Do not use a cushion that reduces friction between the seat and the passenger. The passenger's hips may slide under the lap portion of the seat belt during an accident or a sudden stop.

Serious or fatal internal injuries could result because the seat belt cannot operate properly.

Airbags

You can take steps to reduce the risk of being injured by an inflating airbag. Sitting too close to an airbag greatly increases the risk of injury in the event the airbag inflates. Move your seat as far back as possible from front airbags, while still maintaining control of the vehicle.

WARNING

To reduce the risk of serious injury or death from an inflating airbag:

- Adjust the driver's seat as far to the rear as possible while maintaining your ability to control the vehicle.
 - Adjust the front passenger seat as far to the rear as possible.
 - Hold the steering wheel by the rim with your hands at the 9 o'clock and 3 o'clock positions to minimize the risk of injuries to your hands and arms.
 - Never place anything or anyone between you and the airbag.
 - Do not allow the front passenger to place feet or legs on the dashboard to minimize the risk of leg injuries.
-

Seat belts

Always fasten your seat belt before starting any trip. At all times, passengers should sit upright and be properly restrained with a seat belt. Infants and small children must be restrained in appropriate Child Restraint Systems. Children who have outgrown a booster seat and adults must be restrained using the seat belts.

WARNING

To prevent serious injury or death:

- Never use one seat belt for more than one occupant.
 - Always position the seatback upright with the lap portion of the seat belt snug and low across the hips.
 - Never allow children or small infants to ride on a passenger's lap.
 - Do not route the seat belt across your neck, across sharp edges, or reroute the shoulder strap away from your body.
 - Do not allow the seat belt to become caught or jammed.
-

Front seats

The front seat can be adjusted by using the control switches located on the outside of the seat cushion. Before driving, adjust the seat to the proper position so that you can easily control the steering wheel, foot pedals and controls on the instrument panel.

WARNING

Take the following precautions when adjusting your seat:

- Never attempt to adjust the seat while the vehicle is moving. The seat could respond with unexpected movement and may cause loss of vehicle control resulting in an accident.
- Do not place anything under the front seats. Loose objects in the driver's foot area could interfere with the operation of the foot pedals, causing an accident.
- Do not allow anything to interfere with the normal position and proper locking of the seatback.
- Do not place a cigarette lighter on the floor or seat. When you operate the seat, gas may exit out of the lighter causing a fire.
- Use extreme caution when picking up small objects trapped under the seats or between the seat and the center console. Your hands might be cut or injured by the sharp edges of the seat mechanism.
- If there are occupants in the rear seats, be careful while adjusting the front seat position.
- Make sure that the seat is locked in place after the adjustment. If not, the seat might move unexpectedly resulting in an accident.

CAUTION

To prevent injury:

- Do not adjust your seat while wearing your seat belt. Moving the seat cushion forward may cause strong pressure on your abdomen.
- Do not allow your hands or fingers to get caught in the seat mechanisms while the seat is moving.

Reclining seatback

Sitting in a reclined position when the vehicle is in motion can be dangerous. Even when buckled up, the protections of your restraint system (seat belts and airbags) is greatly reduced by reclining your seatback.

WARNING

- Never ride with a reclined seatback when the vehicle is moving.
Riding with a reclined seatback increases your chance of serious or fatal injuries in the event of a collision or sudden stop.
Driver and passengers should always sit well back in their seats, properly belted, and with the seatbacks upright.
- Seat belts must be snug against your hips and chest to work properly. When the seatback is reclined, the shoulder belt cannot do its job because it will not be snug against your chest. Instead, it will be in front of you. During an accident, you could be thrown into the seat belt, causing neck or other injuries.
The more the seatback is reclined, the greater chance the passenger's hips will slide under the lap belt or the passenger's neck will strike the shoulder belt.

Manual seats - Seat adjustment (Passenger's seat)

 if equipped

The front seat can be adjusted by using the levers located underneath the front part of the seat or on the outer side of the seat. Before driving, adjust the seat to the proper position so that you can easily control the steering wheel, foot pedals and controls on the instrument panel.

Forward and rearward adjustment



To move the seat forward or rearward:

1. Pull up the seat slide adjustment lever and hold it.
2. Slide the seat to the desired position.
3. Release the lever and make sure the seat is locked in place. Move forward and rearward without using the lever. If the seat moves, it is not locked properly.

Seatback angle



To recline the seatback:

1. Lean forward slightly and lift up the seatback lever.
2. Carefully lean back on the seat and adjust the seatback to the desired position.
3. Release the lever and make sure the seatback is locked in place.

Seat height



To change the height of the seat cushion:

- Push down on the lever several times, to lower the seat cushion.
- Pull up on the lever several times, to raise the seat cushion.

Power seats - Seat adjustments

 if equipped

WARNING

Never allow children in the vehicle unattended. The power seats are operable when the vehicle is turned off.

NOTICE

To prevent damage to the seats:

- Always stop adjusting the seats when the seat has been adjusted as far forward or rearward as possible.
- Do not adjust the seats longer than necessary when the vehicle is turned off. This may result in unnecessary battery drain.
- Do not operate two or more seats at the same time. This may result in an electrical malfunction.

Forward and rearward adjustment



To move the seat forward or rearward:

1. Push the control switch forward or rearward.
2. Release the switch once the seat reaches the desired position.

Seat cushion tilt/height adjustment

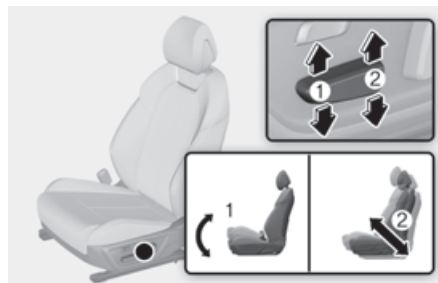

Seat cushion tilt (1)

To change the angle of the front part of the seat cushion:

1. Push the front portion of the control switch up to raise or down to lower the front part of the seat cushion.
2. Release the switch once the seat reaches the desired position.

Seat cushion height (2)

To change the height of the seat cushion:

1. Push the rear portion of the control switch up to raise or down to lower the height of the seat cushion.
2. Release the switch once the seat reaches the desired position.

Seatback angle adjustment



To recline the seatback:

1. Push the control switch forward or rearward.
2. Release the switch once the seatback reaches the desired position.

Seat cushion extension adjustment (for driver's seat)

 if equipped

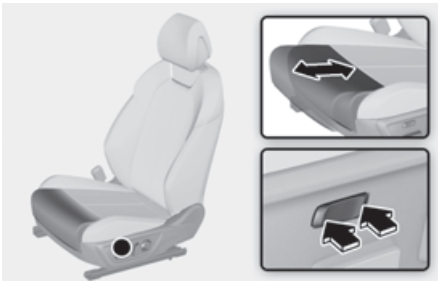

To move the front part of the cushion forward or rearward:

1. Push the control switch forward or rearward.
2. Release the switch once the seat cushion reaches the desired length.

Lumbar support

 if equipped

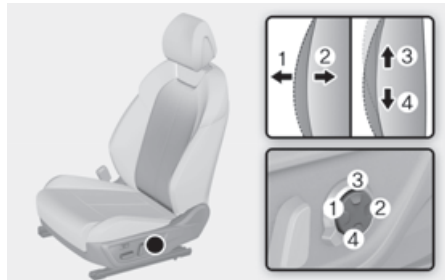

To adjust the lumbar support:

1. Press the front portion of the switch (1) to increase support or the rear portion of the switch (2) to decrease support.
2. Press switch (3) or (4) to move the support position up or down.
3. Release the switch once the lumbar support reaches the desired position.

Seat bolster adjustment (for driver's seat)

 if equipped

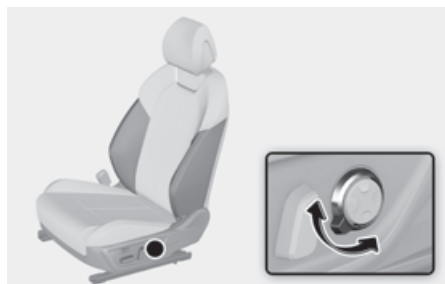

To adjust seat bolster:

1. Push the adjustment lever clockwise, the seatback bolster will be adjusted inward. Push the switch counterclockwise, the seatback bolster will be adjusted outward.
2. Release the lever once the bolster reaches the desired position.

Walk-in switch

 if equipped



The rear seat passenger may use the switches to control the front passenger seat.

- Sliding forward or rearward:
Press the switch (1) or (2) to move the front passenger seat forward or rearward.
- Seatback angle:
Press the switch (3) or (4) to recline the front passenger seatback forward or rearward.

Seatback pocket

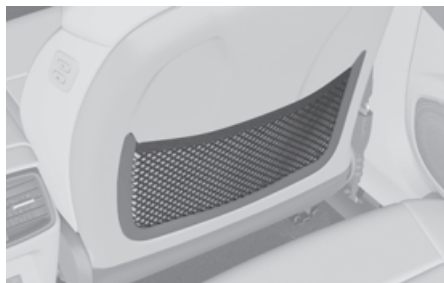

The seatback pocket is provided on the back of the front seatbacks.

CAUTION

Do not put heavy or sharp objects in the seatback pockets. In an accident they could come loose from the pocket and injure occupants.

Rear seats

WARNING

Take the following precautions:

- Adjusting the seats
 - Never attempt to adjust the seat while the vehicle is moving. The seat may suddenly move and may injure the passenger.
 - Make sure that the seat is locked in place after the adjustment. If not, the seat might move unexpectedly resulting in an accident.
- Folding the seats
 - Do not fold the seatback when the seat is occupied (i.e. passenger, pets or luggage). It may injure the passenger or pet, or damage the luggage.
 - Never allow passengers to sit on top of the folded down seatback while the vehicle is moving. This is not a proper seating position and no seat belts are available for use. This could result in serious injury or death in case of an accident or sudden stop.
 - Objects carried on the folded down seatback should not extend higher than the top of the front seatbacks. This could allow cargo to slide forward and cause injury or damage during sudden stops.
 - When returning the rear seatback from a folded to an upright position, hold the seatback and return it slowly. Ensure that the seatback is completely locked into its upright position by pushing on the top of the seatback. In an accident or sudden stop, the unlocked seatback could allow cargo to move forward with great force and enter the passenger compartment, which could result in serious injury or death.

- Loading cargo
 - Make sure the engine is off, the gear shifted to P (Park), and the parking brake is securely applied whenever loading or unloading cargo. Failure to take these steps may allow the vehicle to move if the shift button or shift dial is inadvertently pressed or rotated to another position.
 - When cargo is loaded through the rear passenger seats, ensure the cargo is properly secured to prevent it from moving while driving.
 - Do not place objects in the rear seats, since they cannot be properly secured and may hit vehicle occupants in a collision causing serious injury or death.
-

CAUTION

Do not allow your hands or fingers to get caught in the seat mechanisms while the seat is moving.

NOTICE

To prevent damage to the vehicle:

- Rear seat belts
 - Before folding the seatback, insert the seat belt buckle in the holder between the seatback and cushion. And insert the seat belt webbing in the guide to prevent the seat belt from being damaged.
 - Cargo
 - Be careful when loading cargo through the rear passenger seats to prevent damage to the vehicle interior.
-

CAUTION

Remote folding

Do not strongly push back the seat back to lock. It may unlock and return by repulsive power.

WARNING

Remote folding

Do not fold the rear seats, if passengers, pets or luggage are in the rear seats or on the folded seats. It may cause injury or damage to passengers, pets, luggage.

WARNING

2nd row right side seat folding (Shooting Brake)

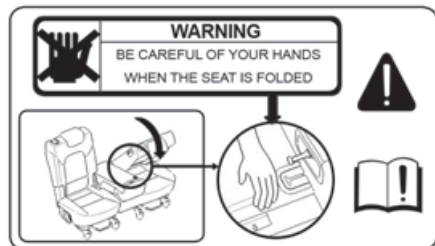

Be careful when you fold the 2nd row right side seat, if the center seat is folded. It may cause injury or damage to you.

Folding the rear seat

To fold down the rear seatback:

1. Set the front seatback to the upright position and if necessary, slide the front seat forward.
2. Lower the rear headrests to the lowest position.

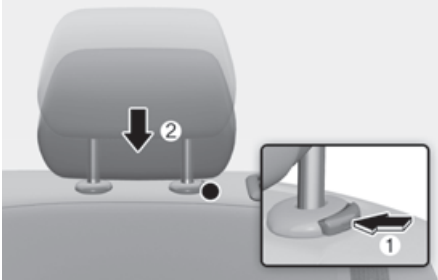

3. Locate the seatbelt toward the outboard position before folding down the seatback to avoid the seatbelt system interfering with the seatback.



4. Pull up the seatback folding lever, then fold the seat toward the front of the vehicle.



To unfold the rear seatback:

1. To use the rear seat, lift and push the seatback rearward.



2. Push the seatback firmly until it clicks into place. Make sure the seatback is locked in place.
3. Return the rear seat belt to the proper position.

Seatback remote folding (Shooting Brake)

+ if equipped

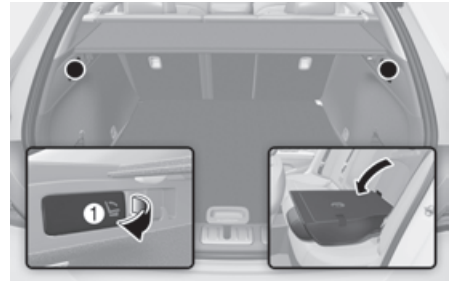

Pull the rear seat back folding switch (1) located in the both sides of the cargo area.

Folding the rear center seat (Shooting Brake)

 if equipped



Additional cargo space is provided to accommodate long/narrow cargo (skis, poles, etc.) not able to fit properly in the tailgate when closed.

1. Lower the rear center headrest to the lowest position.
2. Pull the armrest down.
3. Pull the lever (1) to unlock the center seatback.
4. After unlocking, pull the center seatback down and fold it.

Armrest



The armrest is located in the center of the rear seat.

Pull the armrest down from the seatback to use it.

Headrest

The vehicle's front and rear seats have adjustable headrests. The headrests provide comfort for passengers, but more importantly they are designed to help protect passengers from whiplash and other neck and spinal injuries during an accident, especially in a rear impact collision.

WARNING

To reduce the risk of serious injury or death in an accident, take the following precautions when adjusting your headrests:

- Always properly adjust the headrests for all passengers BEFORE starting the vehicle.
- Never let anyone ride in a seat with the headrest removed or reversed.
- Adjust the headrests so the middle of the headrest is at the same height as the height of the top of the eyes.

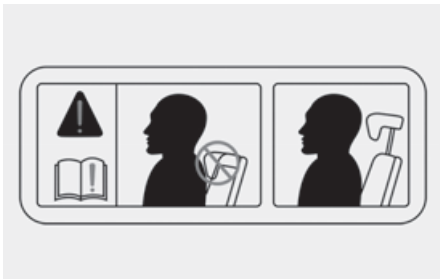

- Never adjust the headrest position of the driver's seat when the vehicle is in motion.
- Adjust the headrest as close to the passenger's head as possible. Do not use a seat cushion that holds the body away from the seatback.
- Make sure the headrest locks into position after adjusting it.

⚠ WARNING

When sitting on the rear seat, do not adjust the height of the headrest to the lowest position.

⚠ CAUTION

When there is no occupant in the rear seats, adjust the height of the headrest to the lowest position. The rear seat headrest can reduce the visibility of the rear area.

NOTICE

To prevent damage, Never hit or pull on the headrests.

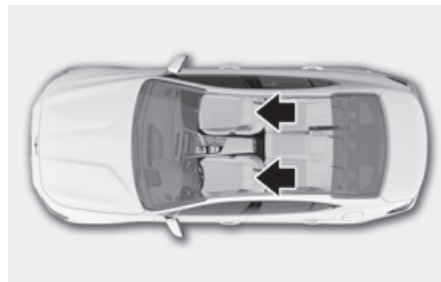
Front seat headrests

The driver's and front passenger's seats are equipped with adjustable headrests for the passengers safety and comfort.

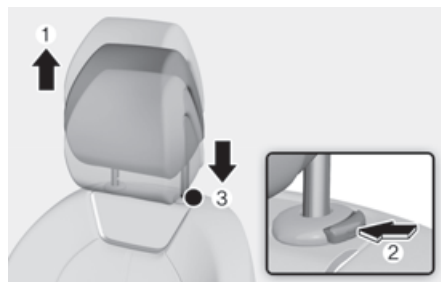
Adjusting the height up and down

To raise the headrest:

1. Pull it up to the desired position (1).

To lower the headrest:

1. Push and hold the release button (2) on the headrest support.
2. Lower the headrest to the desired position (3).

Forward and rearward adjustment



The headrest can be adjusted forward to 3 different positions by pulling the headrest forward to the desired detent. To adjust the headrest to its furthest rearwards position, pull it fully forward to the farthest position and release it.

NOTICE



If you recline the seatback towards the front with the headrest and seat cushion raised, the headrest may come in contact with the sunvisor or other parts of the vehicle.

Removal/Reinstall

Type A



Type B



To remove the headrest:

1. Recline the seatback (2) with the seatback angle switch (1).
2. Raise the headrest as far as it can go.
3. Press the headrest release button (3) while pulling the headrest up (4).

WARNING

Never allow anyone to travel in a seat with the headrest removed.

Type A



Type B

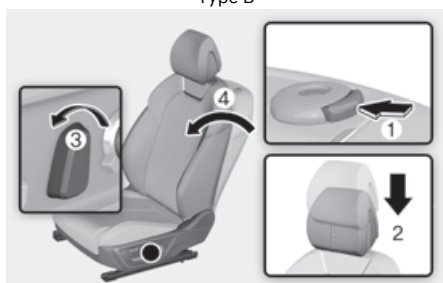

To reinstall the headrest :

1. Recline the seatback.
2. Put the headrest poles (2) into the holes while pressing the release button (1).
3. Adjust the headrest to the appropriate height.
4. Recline the seatback (4) with the seatback angle switch (3).

WARNING

Always make sure the headrest locks into position after reinstalling and adjusting it properly.

Rear seat headrests

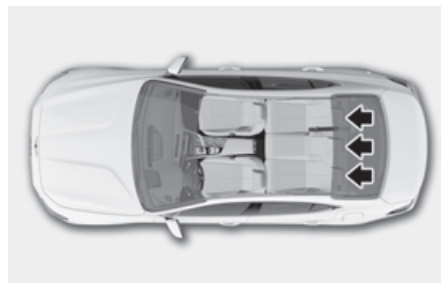

The rear seats are equipped with headrests in all the seating positions for the passenger's safety and comfort.

Adjusting the height up and down

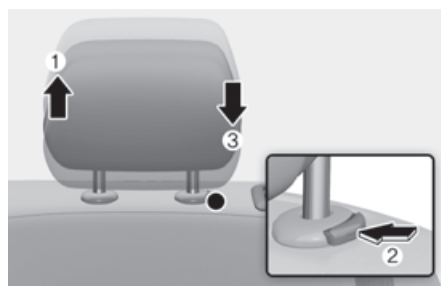

To raise the headrest:

1. Pull it up to the desired position (1).

To lower the headrest:

1. Push and hold the release button (2) on the headrest support.
2. Lower the headrest to the desired position (3).

Seat warmers

 If equipped

Seat warmers are provided to warm the seats during cold weather.

During mild weather or under conditions where the operation of the seat warmer is not needed, keep the seat warmers OFF.

WARNING

The seat warmers can cause a **SERIOUS BURN**, even at low temperatures and especially if used for long periods of time.

Passengers must be able to feel if the seat is becoming too warm so they can turn it off, if needed.

People who cannot detect temperature change or pain to the skin should use extreme caution, especially the following types of passengers:

- Infants, children, elderly or disabled persons, or hospital outpatients.
 - People with sensitive skin or who burn easily.
 - Fatigued individuals.
 - Intoxicated individuals.
 - People taking medication that can cause drowsiness or sleepiness.
-

WARNING

Never place anything on the seat that insulates against heat when the seat warmer is in operation, such as a blanket or seat cushion. This may cause the seat warmer to overheat, causing a burn or damage to the seat.

NOTICE

To prevent damage to the seat warmers and seats:

- Never use a solvent such as paint thinner, benzene, alcohol or gasoline to clean the seats.
 - Do not place heavy or sharp objects on seats equipped with seat warmers.
 - Do not change the seat cover. It may damage the seat warmer.
-

Front seat warmers

+ if equipped

1. While the engine is running, press **^** next to the driver's seat or front passenger's seat, which requires heating, from the climate control information screen.

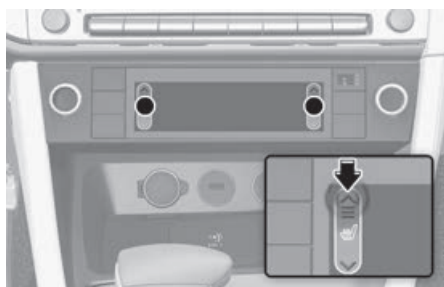

2. When you press the **^** button in the high state, it is high, and you can move it in the order of medium, low, and off by pressing the **v** button.
 - The seat warmer temperature is lowered automatically and then goes off after a certain time to prevent low temperature burns. Press **^** or **v** to adjust the temperature again. If high temperature is selected again after the seat warmer turns off, the temperature is controlled automatically again.
 - To turn on the seat warmer when the air ventilation seat is turned on, press **^** until the seat warmer is turned on.

- **Warmer/ventilation based on climate settings** (for driver's seat)

The seat warmer automatically controls the seat temperature depending on the ambient temperature and the set climate control temperature when the engine is running. If the seat warmer switch or icon is pressed, the seat warmer is controlled manually.

To use this feature, it can be enabled from the Settings menu in the infotainment system.

Select: **Setup (Settings) > Vehicle > Seat (or Climate) > Warmer/Ventilation features > Warmer/ventilation based on climate settings > Driver seat warmer/ventilation**

- The seat warmer defaults to the OFF position whenever the Engine Start/Stop button is pressed to the ON position. However, if the **Warmer/ventilation based on climate settings** function is on, the driver's seat warmer turns on and off depending on the ambient temperature and the set climate control temperature.

i Information

The infotainment system may change after software updates. For more information, refer to the manual provided in the infotainment system and the quick reference guide.

Rear seat warmers

 if equipped



While the engine is running, press the seat warmer switch to warm the rear seats.

- Pressing the switch each time will change the temperature in turn from high to medium, low and off.
- The seat warmer temperature is lowered automatically and then goes off after a certain time to prevent low temperature burns. If high temperature is selected again after the seat warmer turns off, the temperature is controlled automatically again.
- The seat warmer defaults to the OFF position whenever Engine Start/Stop button is pressed to the ON position.
- You can also adjust the rear seat warmers from the front seats. With the engine running, touch the seat warmer icon on the climate control system.



Air ventilation seats

 if equipped

The air ventilation seats are provided to cool the front seats by blowing air through small vent holes on the surface of the seat cushions and seatbacks.

When the operation of the air ventilation seat is not needed, keep the air ventilation seats OFF.

NOTICE



To prevent damage to the air ventilation seats:

- Never use a solvent such as paint thinner, benzene, alcohol or gasoline to clean the seats.
- Avoid spilling liquids on the surface of the front seats and seatbacks; this may cause the air vent holes to become blocked and not work properly.
- Do not place materials such as plastic bags or newspapers under the seats. They may block the air intake causing the air vents to not work properly.
- Do not change the seat covers. It may damage the air ventilation seat.
- If the air vents do not operate, restart the vehicle. If there is no change, we recommend that you have your vehicle inspected by an authorized of retailer Genesis Branded products.

Front air ventilation seats

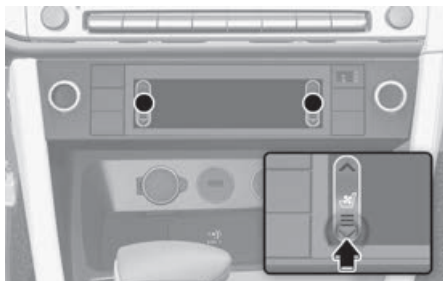
+ if equipped



1. While the engine is running, press  next to the seat which requires ventilating from the climate control information screen.
 - The air ventilation seat is turned on as low.
2. When you press the  button in the strong state, it is strong, and you can move it in the order of medium, weak, and off by pressing the  button.
 - **Warmer/ventilation based on climate settings** (for driver's seat)

The air ventilation seat automatically controls the seat temperature depending on the ambient temperature and the set climate control temperature when the engine is running.

To use this feature, it can be enabled from the Settings menu in the infotainment system.

Select: **Setup (Settings) > Vehicle > Seat (or Climate) > Warmer/Ventilation > Warmer/ventilation based on climate settings > Driver seat warmer/ventilation**

- The air ventilation seat defaults to the OFF position whenever the Engine Start/Stop button is pressed to the ON position. However, if the **Warmer/ventilation based on climate settings** function is on, the driver's air ventilation seat turns on and off depending on the ambient temperature and the set climate control temperature.

i Information

The infotainment system may change after software updates. For more information, refer to the manual provided in the infotainment system and the quick reference guide.

Seat belts

This section describes how to use the seat belts properly. It also describes some of the things not to do when using seat belts.

Seat belt safety precautions

Always fasten your seat belt and make sure all passengers have fastened their seat belts before starting any trip. Airbags are designed to supplement the seat belt as an additional safety device, but they are not a substitute. Most countries require all occupants of a vehicle to wear seat belts.

WARNING

Seat belts must be used by ALL passengers whenever the vehicle is moving. Take the following precautions when adjusting and wearing seat belts:

- Children under the age of 13 should be properly restrained in the rear seats.
- Never allow children to ride in the front passenger seat, unless the airbag is deactivated. If a child is seated in the front passenger seat, move the seat as far back as possible. And the child must always be restrained in the seat properly.
- Never allow an infant or child to be carried on an occupant's lap.
- Never ride with the seatback reclined when the vehicle is moving.
- Do not allow children to share a seat or seat belt.
- Do not wear the shoulder belt under your arm or behind your back.
- Always wear both the shoulder portion and lap portion of the lap/shoulder belt.

- Never wear a seat belt over fragile objects. If there is a sudden stop or impact, the seat belt can damage it.
- Do not use the seat belt if it is twisted. A twisted seat belt will not protect you properly in an accident.
- Do not use a seat belt if the webbing or hardware is damaged.
- Do not latch the seat belt into the buckles of other seats.
- Never unfasten the seat belt while driving. This may cause loss of vehicle control resulting in an accident.
- Make sure there is nothing in the buckle interfering with the seat belt latch mechanism, because any materials in the buckle can cause the seat belt not to be fastened securely.
- No modifications or additions should be made by the user which will either prevent the seat belt adjusting devices from operating to remove slack, or prevent the seat belt assembly from being adjusted to remove slack.

WARNING

Damaged seat belts and seat belt assemblies will not operate properly. Always replace:

- Frayed, contaminated, or damaged webbing.
 - Damaged hardware.
 - The entire seat belt assembly after it has been worn in an accident, even if damage to webbing or assembly is not apparent.
-

Seat belt warning light

Driver's seat belt warning

Instrument cluster



As a reminder to the driver, the seat belt warning light will illuminate for about 6 seconds each time the Engine Start/Stop button is in the ON position regardless of seat belt fastening.

If the seat belt is not fastened when the Engine Start/Stop button is in the ON position or if it is disconnected after the Engine Start/Stop button is in the ON position, the seat belt warning light will illuminate until the belt is fastened.

If you start to drive without the seat belt fastened or you unfasten the seat belt when you drive under 20 km/h (12 mph), the corresponding warning light will continue to illuminate until you fasten the seat belt.

If you continue to drive without the seat belt fastened or you unfasten the seat belt when you drive over 20 km/h (12 mph), the seat belt warning chime will sound for about 100 seconds and the corresponding warning light will blink.

Front passenger's seat belt warning

 if equipped

As a reminder to the front passenger, the front passenger's seat belt warning lights will illuminate for about 6 seconds each time the Engine Start/Stop button is in the ON position regardless of belt fastening.

If the seat belt is not fastened when the Engine Start/Stop button is in the ON position or if it is disconnected after the Engine Start/Stop button is in the ON position, the seat belt warning light will illuminate until the belt is fastened.

If you start to drive without the seat belt fastened or you unfasten the seat belt when you drive under 20km/h (12 mph), the corresponding warning light will continue to illuminate until you fasten the seat belt.

If you continue to drive without the seat belt fastened or you unfasten the seat belt when you drive over 20 km/h (12 mph), the seat belt warning chime will sound for about 100 seconds and the corresponding warning light will blink.

WARNING

Riding in an improper position adversely affects the front passenger's seat belt warning system. It is important for the driver to instruct the passenger to seated properly as instructed in this manual.

Information

- Although the front passenger seat is not occupied, the seat belt warning light will blink or illuminate for 6 seconds.
- The front passenger's seat belt warning may operate when luggage is placed on the front passenger seat.

Rear passenger's seat belt warning

 if equipped



Rear outboard seat seatbelt

As a reminder to the rear outboard seat passengers, the corresponding seat belt warning lights will illuminate for about 6 seconds each time the Engine Start/Stop button is in the ON position regardless of belt fastening.

And then, if the seat belt is still not fastened while driving, or unfastened while driving, it will operate as follows depending on vehicle speed.

- Below 20 km/h (12 mph):

The corresponding seat belt warning light will illuminate until the seatbelt is fastened.

- Above 20 km/h (12 mph):

The corresponding seat belt warning light will blink and the warning chime will sound for about 35 seconds, and the warning light will continue to illuminate until the seatbelt is fastened.

Rear center seatbelt

With the engine on, if the second row center seat passenger's seat belt is not fastened, the corresponding seat belt warning light will illuminate for 70 seconds. But, if the seatbelt is fastened after 6 seconds, the corresponding seat belt warning light will immediately turn off.

If the seat belt was fastened, and was unfastened while driving below 20 km/h (12 mph), the corresponding seat belt warning light will illuminate for 70 seconds.

If the seat belt was fastened, and was unfastened while driving above 20 km/h (12 mph), the corresponding seat belt warning light will blink and the warning chime will sound for about 35 seconds.

Seat belt restraint system

Lap/shoulder belt

To fasten your seat belt:

Pull the belt out of the retractor and insert the metal tab (1) into the buckle (2). There will be an audible “click” when the tab locks into the buckle.

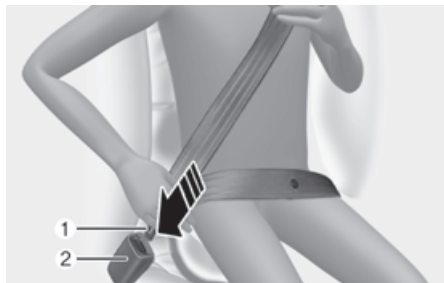

You should place the lap belt (1) portion across your hips and the shoulder belt (2) portion across your chest.



The seat belt automatically adjusts to the proper length after the lap belt portion is adjusted manually so that it fits snugly around your hips. If you lean forward in a slow, easy motion, the belt will extend and move with you.

If there is a sudden stop or impact, the belt will lock into position. It will also lock if you try to lean forward too quickly.

NOTICE

If you are not able to smoothly pull enough of the seat belt out from the retractor, firmly pull the seat belt out and release it. After release, you will be able to pull the belt out smoothly.

⚠ WARNING



Improperly positioned seat belts may increase the risk of serious injury in an accident. Take the following precautions when adjusting the seat belt:

- Position the lap portion of the seat belt as low as possible across your hips, not on your waist, so that it fits snugly. This allows your strong pelvic bones to absorb the force of the crash, reducing the chance of internal injuries.
- Position one arm under the shoulder belt and the other over the belt, as shown in the illustration.
- Always position the shoulder belt anchor into the locked position at the appropriate height.
- Never position the shoulder belt across your neck or face.

Height adjustment

You can adjust the height of the shoulder belt anchor to one of the four different positions for maximum comfort and safety.

The shoulder portion should be adjusted so it lies across your chest and midway over your shoulder nearest the door, not over your neck.

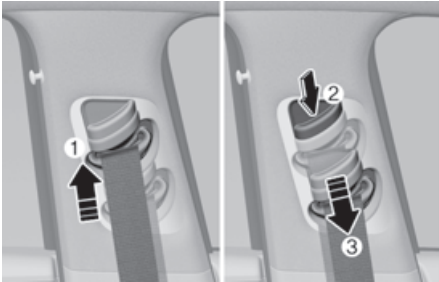

To adjust the height of the seat belt anchor, lower or raise the height adjuster into an appropriate position.

To raise the height adjuster, pull it up (1). To lower it, push it down (2) while pressing the height adjuster button (3).

Release the button to lock the anchor into position. Try sliding the height adjuster to make sure that it has locked into position.

To release your seat belt:

Press the release button (1) in the locking buckle.

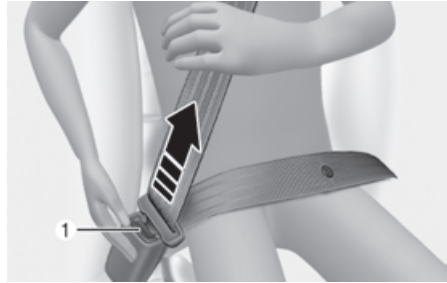

When it is released, the belt should automatically draw back into the retractor. If this does not happen, check the belt to be sure it is not twisted, then try again.

Rear center seat belt

+ if equipped

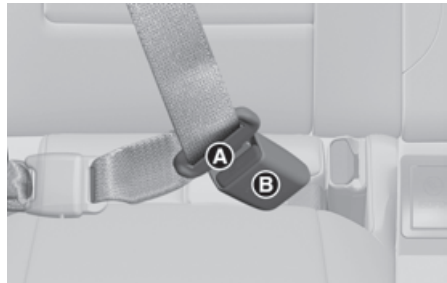

1. Take out the buckle (B), which is stored between the seat/seatback cushions.
2. Insert the metal plate (A) into the buckle (B), until it clicks.

You can make sure its secure fastening by pulling the seatbelt webbing. The buckle with "CENTER" mark should be used for the 3-point seatbelt.

3. Restore the buckle between the seat/seatback cushion after unfastening the seatbelt.

Pretensioner seat belt



Your vehicle is equipped with driver's, front passenger's and rear passengers Pretensioner Seat Belts (Retractor Pretensioner and Emergency Fastening Device System). The purpose of the pretensioner is to make sure the seat belts fit tightly against the occupant's body in certain frontal or side collision(s). The Emergency Fastening Device System may be activated in certain crashes where the frontal or side collision(s) is severe enough, together with the airbags.

When the vehicle stops suddenly, or if the occupant tries to lean forward too quickly, the seat belt retractor will lock into position. In certain frontal or side collision(s), the pretensioner will activate and pull the seat belt into tighter contact against the occupant's body.

(1) Retractor Pretensioner

The purpose of the retractor pretensioner is to make sure that the shoulder belts fit in tightly against the occupant's upper body in certain frontal or side collision(s).

(2) Emergency Fastening Device System

The purpose of the Emergency Fastening Device System is to make sure that the pelvic belts fit in tightly against the occupant's lower body in certain frontal or side collision(s).

If the system senses excessive tension on the driver or passenger's seat belt when the pretensioner system activates, the load limiter inside the retractor pretensioner will release some of the pressure on the affected seat belt. (if equipped with load limiter).

WARNING

- Always wear your seat belt and sit properly in your seat.
- Do not use the seat belt if it is loose or twisted. A loose or twisted seat belt will not protect you properly in an accident.
- Do not place anything near the buckle. This may adversely affect the buckle and cause it to function improperly.
- Always replace your pre-tensioners after activation or an accident.
- Never inspect, service, repair or replace the pre-tensioners by yourself. We recommend that you have the pre-tensioners inspected, serviced, repaired or replaced by an authorized retailer of Genesis Branded products.
- Do not hit the seat belt assemblies.

WARNING

Do not touch the pretensioner seat belt assemblies for several minutes after they have been activated. When the pretensioner seat belt mechanism deploys during a collision, the pretensioner can become hot and can burn you.

CAUTION

Body work on the front area of the vehicle may damage the pretensioner seat belt system. Therefore, we recommend the system to be serviced by an authorized retailer of Genesis Branded products.

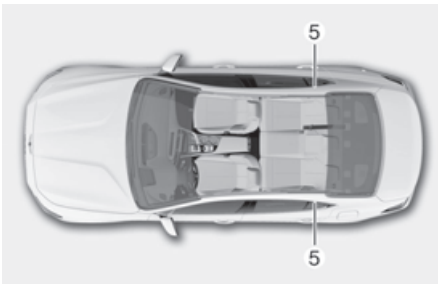
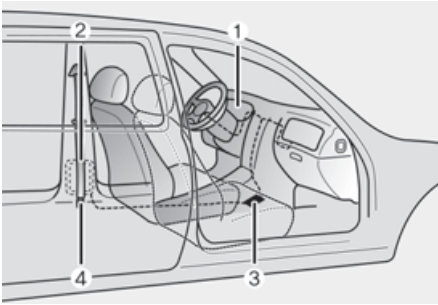

The Pre-Tensioner Seat Belt System consists mainly of the following components. Their locations are shown in the illustration above:

- (1) SRS airbag warning light
- (2) Retractor pretensioner
- (3) SRS control module
- (4) Emergency Fastening Device
- (5) Rear Retractor pretensioner (if equipped)

NOTICE

The sensor that activates the SRS control module is connected with the pretensioner seat belts. The SRS airbag warning light on the instrument cluster will illuminate for about three to six seconds after the Engine Start/Stop button is in the ON position, and then it should turn off.

If the pretensioner is not working properly, the warning light will illuminate even if the SRS airbag is not malfunctioning. If the warning light does not illuminate, stays illuminated or illuminates when the vehicle is being driven, we recommend the pretensioner seat belts and/or SRS control module be inspected by an authorized retailer of Genesis Branded products as soon as possible.

i Information

- Pretensioner seat belts may be activated in certain frontal or side collisions or rollover situations (if equipped with rollover sensor).
- When the pretensioner seat belts are activated, a loud noise may be heard and fine dust, which may appear to be smoke, may be visible in the passenger compartment. These are normal operating conditions and are not hazardous.
- Although it is non-toxic, the fine dust may cause skin irritation and should not be inhaled for prolonged periods. Wash all exposed skin areas thoroughly after an accident in which the pretensioner seat belts were activated.

Load limiter

If a seatbelt places an excessive load on the chest during a vehicle crash, a load limiter equipped with the seatbelt reduces the pressure on the chest.

Additional seat belt safety precautions

Seat belt use during pregnancy

The seat belt should always be used during pregnancy. The best way to protect your unborn child is to protect yourself by always wearing the seat belt.

Pregnant women should always wear a lap-shoulder seat belt. Place the shoulder belt across your chest, routed between your breasts and away from your neck. Place the lap belt below your belly so that it fits **SNUGLY** across your hips and pelvic bone, under the rounded part of the belly.

⚠ WARNING

- Pregnant women and patients are more vulnerable to any impacts on the abdomen during an abrupt stop or accident. If you are in an accident while pregnant, consult your doctor.
- To reduce the risk of serious injury or death to an unborn child during an accident, pregnant women should never place the lap portion of the seat belt above or over the area of the abdomen where the unborn child is located.

Seat belt use and children

Infant and small children

Most countries have Child Restraint System laws which require children to travel in approved Child Restraint System devices, including booster seats. The age at which seat belts can be used instead of Child Restraint System differs among countries, so you should be aware of the specific requirements in your country, and where you are travelling. Infant and Child Restraint System must be properly placed and installed in a rear seat.

For more information, refer to the “Child Restraint System (CRS)” section in this chapter.

⚠ WARNING

Always properly restrain infants and small children in a Child Restraint System appropriate for the child’s height and weight.

To reduce the risk of serious injury or death to a child and other passengers, Never hold a child in your lap or arms when the vehicle is moving. The violent forces created during an accident will tear the child from your arms and throw the child against the interior of the vehicle.

Small children are best protected from injury in an accident when properly restrained in the rear seat by a Child Restraint System that meets the requirements of the Safety Standards of your country. Before buying any Child Restraint System, make sure that it has a label certifying that it meets Safety Standard of your country.

The Child Restraint System must be appropriate for your child’s height and weight. Check the label on the Child Restraint System for this information. Refer to the “Child Restraint System (CRS)” section in this chapter.

Larger children

Children under age 13 and who are too large for a booster seat should always occupy the rear seat and use the available lap/shoulder belts. A seat belt should lie across the upper thighs and be snug across the shoulder and chest to restrain the child safely. Check belt fit periodically. A child's squirming could put the belt out of position. In the event of an accident, children are afforded the best safety restrained by a proper Child Restraint System in the rear seats.

If a larger child over age 13 must be seated in the front seat, the child must be securely restrained by the available lap/shoulder belt and the seat should be placed in the rearmost position.

If the shoulder belt portion slightly touches the child's neck or face, try placing the child closer to the center of the vehicle. If the shoulder belt still touches their face or neck, they need to be returned to an appropriate booster seat in the rear seat.

WARNING

- Always make sure larger children's seat belts are worn and properly adjusted.
- Never allow the shoulder belt to contact the child's neck or face.
- Do not allow more than one child to use a single seat belt.

Transporting an injured person

A seat belt should be used when an injured person is being transported. Consult a physician for specific recommendations.

One person per belt

Two people (including children) should never attempt to use a single seat belt. This could increase the severity of injuries in case of an accident.

Do not lie down

Sitting in a reclined position when the vehicle is in motion can be dangerous. Even when buckled up, the protections of your restraint system (seat belts and/or airbags) is greatly reduced by reclining your seatback.

Seat belts must be snug against your hips and chest to work properly.

During an accident, you could be thrown into the seat belt, causing neck or other injuries.

The more the seat back is reclined, the greater the chance for the passenger's hips to slide under the lap belt or the passenger's neck to strike the shoulder belt.

WARNING

- Never ride with a reclined seatback when the vehicle is moving.
 - Riding with a reclined seatback increases your chance of serious or fatal injuries in the event of a collision or sudden stop.
 - Driver and passengers should always sit well back in their seats with the seatbacks upright and should be belted properly.
-

Care of seat belts

Seat belt systems should never be disassembled or modified. In addition, care should be taken to assure that seat belts and belt hardware are not damaged by seat hinges, doors or other abuse.

Periodic inspection

All seat belts should be inspected periodically for wear or damage of any kind. Any damaged parts should be replaced as soon as possible.

Keep belts clean and dry

Seat belts should be kept clean and dry. If belts become dirty, they can be cleaned by using a mild soap solution and warm water. Bleach, dye, strong detergents or abrasives should not be used because they may damage and weaken the fabric.

When to replace seat belts

The entire seat belt assembly or assemblies should be replaced if the vehicle has been involved in an accident. This should be done even if no damage is visible. We recommend that you consult an authorized retailer of Genesis Branded products.

Child Restraint System (CRS)

Our recommendation: Children always in the rear

WARNING

Always properly restrain children in the vehicle. Children of all ages are safer when riding in the rear seats. Never place a rearward-facing Child Restraint System on the front passenger seat, unless the airbag is deactivated.

Children under age 13 should always ride in the rear seats and must always be properly restrained to minimize the risk of injury in an accident, sudden stop or sudden maneuver.

According to accident statistics, children are safer when properly restrained in the rear seats than in the front seat. Children too large for a Child Restraint System must use the seat belts provided.

Most countries have regulations which require children to travel in approved Child Restraint Systems.

The laws governing the age or height/weight restrictions at which seat belts can be used instead of Child Restraint System differs among countries, so you should be aware of the specific requirements in your country, and where you are travelling.

Child Restraint Systems must be properly installed in the vehicle seat. Always use a commercially available Child Restraint System that meets the requirements of your country.

Child Restraint System (CRS)

Infants and younger children must be restrained in an appropriate rearward-facing or forward-facing CRS that has first been properly secured to the seat of the vehicle. Read and comply with the instructions for installation and use provided by the manufacturer of the Child Restraint System.

WARNING

- Always follow the Child Restraint System manufacturer's instructions for installation and use.
 - Always properly restrain your child in the Child Restraint System.
 - Do not use an infant carrier or a child safety seat that "hooks" over a seatback, it may not provide adequate protection in an accident.
 - After an accident, we recommend a retailer of Genesis Branded products to check the Child Restraint System, seat belts, ISOFIX anchorages and top-tether anchorages.
-

Selecting a Child Restraint System (CRS)

When selecting a Child Restraint System for your child, always:

- Make sure the Child Restraint System has a label certifying that it meets applicable Safety Standards of your country.
A Child Restraint System may only be installed if it was approved in accordance with the requirements of ECE-R44 or ECE-R129.
- Select a Child Restraint System based on your child's height and weight. The required label or the instructions for use typically provide this information.
- Select a Child Restraint System that fits the vehicle seating position where it will be used.
- Read and comply with the warnings and instructions for installation and use provided with the Child Restraint System.

Child Restraint System types

There are three main types of Child Restraint Systems: rearward-facing, forward-facing and booster Child Restraint Systems.

They are classified according to the child's age, height and weight.

Rearward-facing Child Restraint System



A rearward-facing Child Restraint System provides restraint with the seating surface against the back of the child. The harness system holds the child in place, and in an accident, acts to keep the child positioned in the Child Restraint Systems and reduce the stress to the fragile neck and spinal cord.

All children under the age of one year must always ride in a rearward-facing Child Restraint System. There are different types of rearward-facing Child Restraint Systems: infant-only Child Restraint Systems can only be used rearward-facing. Convertible and 3-in-1 Child Restraint Systems typically have higher height and weight limits for the rearward-facing position, allowing you to keep your child rearward-facing for a longer period of time.

Keep using Child Restraint Systems in the rearward-facing position as long as children fit within the height and weight limits allowed by the Child Restraint System's manufacturer.

Forward-facing Child Restraint System



A forward-facing Child Restraint System provides restraint for the child's body with a harness. Keep children in a forward-facing Child Restraint System with a harness until they reach the top height or weight limit allowed by your Child Restraint System's manufacturer.

Once your child outgrows the forward-facing Child Restraint System, your child is ready for a booster seat.

Booster seats

A booster seat is a Child Restraint System designed to improve the fit of the vehicle's seat belt system. A booster seat positions the seat belt so that it fits properly over the stronger parts of your child's body. Keep your children in booster seats until they are big enough to fit in a seat belt properly.

For a seat belt to fit properly, the lap belt must lie comfortable across the upper thighs, not the stomach. The shoulder belt should lie comfortable across the shoulder and chest and not across the neck or face. Children under age 13 must always be properly restrained to minimize the risk of injury in an accident, sudden stop or sudden maneuver.

Installing a Child Restraint System (CRS)

WARNING

Before installing your Child Restraint System always:

Read and follow the instructions provided by the manufacturer of the Child Restraint System.

Failure to follow all warnings and instructions could increase the risk of the SERIOUS INJURY or DEATH if an accident occurs.

WARNING

If the vehicle headrest prevents proper installation of a Child Restraint System, the headrest of the respective seating position shall be readjusted or entirely removed.

After selecting a proper Child Restraint System for your child and checking that the Child Restraint System fits properly on the seating position, there are three general steps for a proper installation:

- **Properly secure the Child Restraint System to the vehicle.** All Child Restraint Systems must be secured to the vehicle with the lap belt or lap part of a lap/shoulder belt or with the ISOFIX top-tether and/or ISOFIX anchorage and/or with the support leg.

- **Make sure the Child Restraint System is firmly secured.** After installing a Child Restraint System to the vehicle, push and pull the seat forward and from side-to-side to verify that it is securely attached to the seat. A Child Restraint System secured with a seat belt should be installed as firmly as possible. However, some side-to-side movement can be expected.

When installing a Child Restraint System, adjust the vehicle seat and seatback (up and down, forward and rearward) so that your child fits in the Child Restraint System in a comfortable manner.

- **Secure the child in the Child Restraint System.** Make sure the child is properly strapped in the Child Restraint System according to the Child Restraint System manufacturer's instructions.

CAUTION

A Child Restraint System in a closed vehicle can become very hot. To prevent burns, check the seating surface and buckles before placing your child in the Child Restraint System.

Suitability of each seating position for belted & ISOFIX Child Restraint Systems (CRS) according to UN regulations (For Sedan)

(Information for use by vehicle users and CRS manufacturers)

- Yes: Suitable for fitment of the designated category of CRS
- No: Not suitable for fitment of the designated category of CRS
- -: Not applicable
- The table is based on LHD vehicle. Except for the front passenger seat, the table is valid for RHD vehicle. For RHD vehicle front passenger of number 1, please use information for the seating position number 3.

CRS categories		Seating positions							Remarks
		1	2	3		4	5	6	
				Airbag ON	Airbag OFF				
Universal belted CRS	All mass groups	-	-	No	Yes* ¹ F, R	Yes F, R	Yes* ² F, R	Yes F, R	F: Forward facing R: Rearward facing
i-Size CRS	ISOFIX CRF: F2, F2X, R1, R2	-	-	No	No	Yes F, R	No	Yes F, R	
Carry-cot (ISOFIX lateral facing CRS)	ISOFIX CRF: L1, L2	-	-	No	No	No	No	No	
ISOFIX infant* CRS (*: ISOFIX baby CRS)	ISOFIX CRF: R1	-	-	No	No	Yes R	No	Yes R	
ISOFIX toddler CRS - small	ISOFIX CRF: F2, F2X, R2, R2X	-	-	No	No	Yes F, R ³	No	Yes F, R ³	
ISOFIX toddler CRS - large* (*: not booster seats)	ISOFIX CRF: F3, R3	-	-	No	No	Yes F, R ³	No	Yes F, R ³	
Booster Seat - reduced Width	ISO CRF: B2	-	-	Yes ²	Yes ²	Yes	Yes	Yes	
Booster Seat - full Width	ISO CRF: B3	-	-	Yes ²	Yes ²	Yes	Yes	Yes	

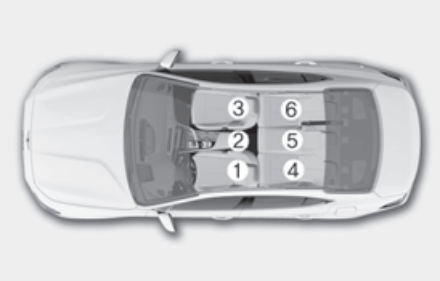
Seat Number	Position in the vehicle	Seating positions
1	Front left	
2	Front center	
3	Front right	
4	2nd row left	
5	2nd row center	
6	2nd row right	

*1 To install Universal CRS, 1st row passenger seat height should be at its highest position.

*2 Never install CRS with a support leg on 2nd row center seating position.

*3 To install R2,R3 CRS to 2nd row outer seating positions, 1st row seat should be up highest position for install of rearward facing CRS.

* Never place a rearward facing Child Restraint System on the front passenger seat, unless the airbag is deactivated.

* For semi-universal or vehicle specific CRS(ISOFIX or belted CRS), please see the vehicle list provided in the manual of CRS.

* If the vehicle headrest prevents proper installation of a CRS, the headrest of the seating position shall be readjusted or entirely removed.

i Information

F: Forward facing, R: Rearward facing

Recommended CRS for Vehicle according to UN regulations

(Information for use by vehicle users and CRS manufacturers)

Mass Group	Name	Manufacturer	Type of Fixation	ECE-R44/R129 Approval No.
Group 0+	BABY-SAFE 2 i-SIZE and BABY-SAFE i-SIZE BASE	Britax Romer	ISOFIX with support leg, rearward facing	R129/00 - E1 - 000008
Group 1	Duo Plus	Britax Romer	ISOFIX mounted	R44/04 - E1 - 04301133
Group 2	KidFix II R	Britax Romer	ISOFIX and vehicle belt, using CRS lap belt guide	R44/04 - E1 - 04301304
Group 3	viaggio 2-3 shuttle	PegPerego	ISOFIX and vehicle belt	ECE R44/04 - E24 - 0000256

CRS Manufacturer informationBritax: <http://www.britax.com>PegPerego: <http://www.pegperego.com/>**NOTICE**

We recommend that the Child Restraint System is used with ISOFIX anchorages.

Suitability of each seating position for belted & ISOFIX Child Restraint Systems (CRS) according to UN regulations (Shooting Brake)

(Information for use by vehicle users and CRS manufacturers)

- Yes: Suitable for fitment of the designated category of CRS
- No: Not suitable for fitment of the designated category of CRS
- -: Not applicable
- The table is based on LHD vehicle. Except for the front passenger seat, the table is valid for RHD vehicle. For RHD vehicle front passenger of number 1, please use information for the seating position number 3.

CRS categories		Seating positions							Remarks
		1	2	3		4	5	6	
				Airbag ON	Airbag OFF				
Universal belted CRS	All mass groups	-	-	No	Yes ^{*1} F, R	Yes F, R	Yes ^{*2} F, R	Yes F, R	F: Forward facing R: Rearward facing
i-size CRS	ISOFIX CRF: F2, F2X, R1, R2	-	-	No	No	Yes F, R	No	Yes F, R	
Carry-cot (ISOFIX lateral facing CRS)	ISOFIX CRF: L1, L2	-	-	No	No	No	No	No	
ISOFIX infant* CRS (*: ISOFIX baby CRS)	ISOFIX CRF: R1	-	-	No	No	Yes R	No	Yes R	
ISOFIX toddler CRS - small	ISOFIX CRF: F2, F2X, R2, R2X	-	-	No	No	Yes F, R ^{*3}	No	Yes F, R ^{*3}	
ISOFIX toddler CRS - large*(*: not booster seats)	ISOFIX CRF: F3, R3	-	-	No	No	Yes F, R ^{*3}	No	Yes F, R ^{*3}	
Booster Seat - reduced Width	ISO CRF: B2	-	-	Yes ^{*2}	Yes ^{*2}	Yes	Yes	Yes	
Booster Seat - full Width	ISO CRF: B3	-	-	Yes ^{*2}	Yes ^{*2}	Yes	Yes	Yes	

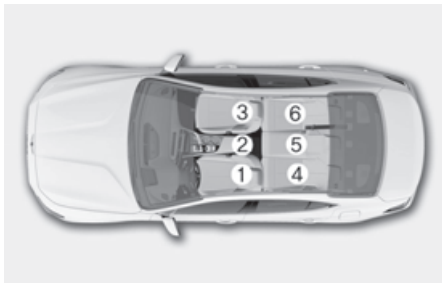
Seat Number	Position in the vehicle	Seating positions
1	Front left	
2	Front center	
3	Front right	
4	2nd row left	
5	2nd row center	
6	2nd row right	

*1 To install Universal CRS, 1st row passenger seat height should be at its highest position.

*2 Never install CRS with a support leg on 2nd row center seating position.

*3 To install R2,R3 CRS to 2nd row outer seating positions, 1st row seat should be up highest position for install of rearward facing CRS.

* Never place a rearward facing Child Restraint System on the front passenger seat, unless the airbag is deactivated.

* For semi-universal or vehicle specific CRS(ISOFIX or belted CRS), please see the vehicle list provided in the manual of CRS.

* If the vehicle headrest prevents proper installation of a CRS, the headrest of the seating position shall be readjusted or entirely removed.

i Information

F: Forward facing, R: Rearward facing

Recommended CRS for Vehicle according to UN regulations

(Information for use by vehicle users and CRS manufacturers)

Mass Group	Name	Manufacturer	Type of Fixation	ECE-R44/R129 Approval No.
Group 0+	BABY-SAFE 2 i-SIZE and BABY-SAFE i-SIZE BASE	Britax Romer	ISOFIX with support leg, rearward facing	R129/00 - E1 - 000008
Group 1	Duo Plus	Britax Romer	ISOFIX mounted	R44/04 - E1 - 04301133
Group 2	KidFix II R	Britax Romer	ISOFIX and vehicle belt, using CRS lap belt guide	R44/04 - E1 - 04301304
Group 3	viaggio 2-3 shuttle	PegPerego	ISOFIX and vehicle belt	ECE R44/04 - E24 - 0000256

CRS Manufacturer information

Britax: <http://www.britax.com>

PegPerego: <http://www.pegperego.com/>

NOTICE

We recommend that the Child Restraint System is used with ISOFIX anchorages.

ISOFIX anchorage and top-tether anchorage (ISOFIX anchorage system) for children

The ISOFIX system holds a Child Restraint System during driving and in an accident. This system is designed to make installation of the Child Restraint System easier and reduce the possibility of improperly installing your Child Restraint System. The ISOFIX system uses anchors in the vehicle and attachments on the Child Restraint System. The ISOFIX system eliminates the need to use seat belts to secure the Child Restraint System to the rear seats.

ISOFIX anchorages are metal bars built into the vehicle. There are two lower anchors for each ISOFIX seating position that will accommodate a Child Restraint System with lower attachments.

To use the ISOFIX system in your vehicle, you must have a Child Restraint System with ISOFIX attachments.

The Child Restraint System manufacturer will provide you with instructions on how to use the Child Restraint System with its attachments for the ISOFIX anchorages.

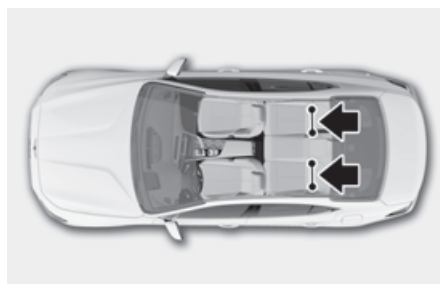

ISOFIX anchorages have been provided in the left and right outboard rear seating positions. Their locations are shown in the illustration.

⚠ WARNING

Do not attempt to install a Child Restraint System using ISOFIX anchorages in the rear center seating position. There are no ISOFIX anchorages provided for this seat. Using the outboard seat anchorages, for the CRS installation on the rear center seating position, can damage the anchorages.

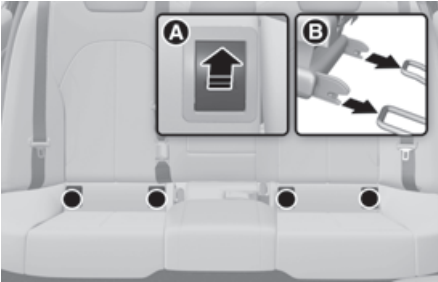

[A] ISOFIX Anchorage Position Indicator (Type A-

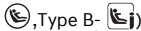

[B] ISOFIX Anchorage

ISOFIX anchorages are located between the seatback and the seat cushion of the rear seat left and right outboard seating positions, indicated by the symbols.

Securing a Child Restraint System with the “ISOFIX Anchorage System”

To install an i-Size or ISOFIX-compatible Child Restraint System in either of the rear outboard seating positions:

1. Move the seat belt buckle away from the ISOFIX anchorages.
2. Move any other objects away from the anchorages that could prevent a secure connection between the Child Restraint System and the ISOFIX anchorages.
3. Place the Child Restraint System on the vehicle seat, then attach the seat to the ISOFIX anchorages according to the instructions provided by the Child Restraint System manufacturer.
4. Follow the instructions of the Child Restraint System’s manufacturer for proper installation and connection of the ISOFIX attachments on the Child Restraint System to the ISOFIX anchorages.

! WARNING

Take the following precautions when using the ISOFIX system:

- Read and follow all installation instructions provided with your Child Restraint System.
- To prevent the child from reaching and taking hold of unretracted seat belts, buckle all unused rear seat belts and retract the seat belt webbing behind the child. Children can be strangled if a shoulder belt becomes wrapped around their neck and the seat belt tightens.
- Never attach more than one Child Restraint System to a single anchorage. This could cause the anchor or attachment to come loose or break.
- Always have the ISOFIX system inspected by your dealer after an accident. An accident can damage the ISOFIX system and may not properly secure the Child Restraint System.

Securing a Child Restraint System seat with “Top-tether Anchorage” system

Sedan

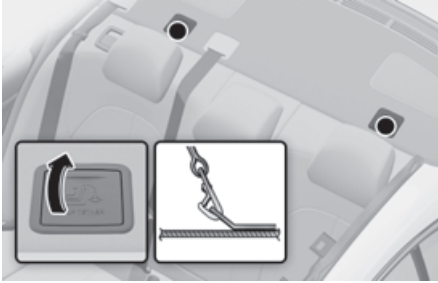

Top-tether anchorages for Child Restraint Systems are located on the package tray.

Shooting Brake



Top-tether anchorages for Child Restraint System are located on the back of the rear seatbacks.

Sedan



Shooting Brake

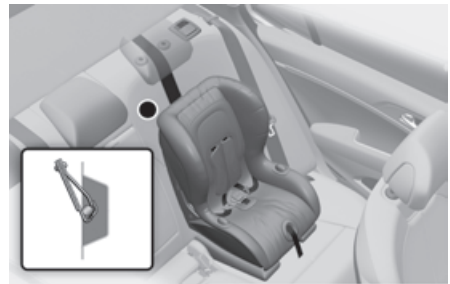

1. Route the Child Restraint System top-tether strap over the seatback. Placing the top tether strap, please follow the instructions of the Child Restraint System manufacturer.
2. Connect the top-tether strap to the top-tether anchorage, then tighten the top-tether strap according to the instructions of your Child Restraint System's manufacturer to firmly attach the Child Restraint System to the seat.

⚠ WARNING

Take the following precautions when installing the top-tether:

- Read and follow all installation instructions provided with your Child Restraint System.
- Never attach more than one Child Restraint System to a single ISOFIX top-tether anchorage. This could cause the anchorage or attachment to come loose or break.
- Do not attach the top-tether to anything other than the correct top-tether anchorage. It may not work properly if attached to something else.
- Child Restraint System anchorages are designed to withstand only those loads imposed by correctly fitted Child Restraint System.

Do not use them for adult seat belts, harnesses, or for attaching other items or equipment to the vehicle.

Securing a Child Restraint System with a lap/shoulder belt

When not using the ISOFIX system, all Child Restraint Systems must be secured to a rear seat with the lap part of a lap/shoulder belt.

Installing a Child Restraint System with a lap/shoulder belt

To install a Child Restraint System on the rear seats, do the following:

1. Place the Child Restraint System on a rear seat and route the lap/shoulder belt around or through the Child Restraint System, following the Child Restraint System manufacturer's instructions. Make sure the seat belt webbing is not twisted.



2. Fasten the lap/shoulder belt latch into the buckle. Listen for the distinct “click” sound.



i Information

Position the release button so that it is easy to access in case of an emergency.

3. Remove as much slack from the belt as possible by pushing down on the Child Restraint System while feeding the shoulder belt back into the retractor.

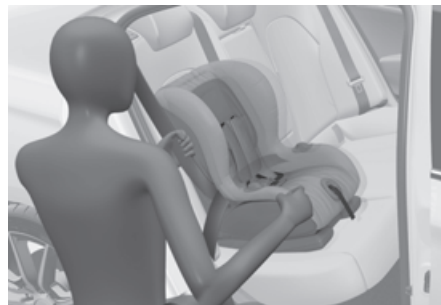

4. Push and pull on the Child Restraint System to confirm that the seat belt is holding it firmly in place.

If your Child Restraint System manufacturer recommends the use of a top-tether with the lap/shoulder belt, refer to the "Securing a Child Restraint System seat with "Top-tether Anchorage" system".

To remove the Child Restraint System, press the release button on the buckle and then pull the lap/shoulder belt out of the Child Restraint System and allow the seat belt to retract fully.

⚠ WARNING

If a child restraint is installed in the second row center seat, move the second row seat far back as possible, to minimize contact with the front center side airbag (if equipped with front center side airbag).

Airbag - supplemental restraint system

Left-hand drive

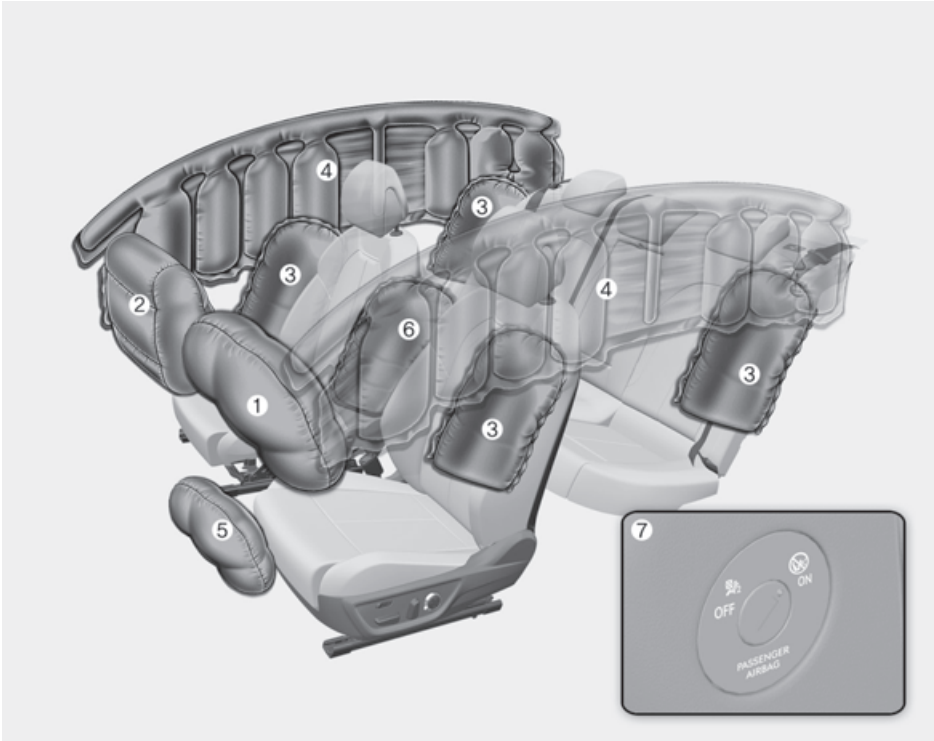

The actual airbags in the vehicle may differ from the illustration.

- (1) Driver's front airbag
- (2) Passenger's front airbag
- (3) Side airbag/rear side airbag (if equipped)
- (4) Curtain airbag
- (5) Driver's knee airbag
- (6) Front center side airbag (if equipped)
- (7) Front passenger airbag ON/OFF switch (if equipped)

Right-hand drive

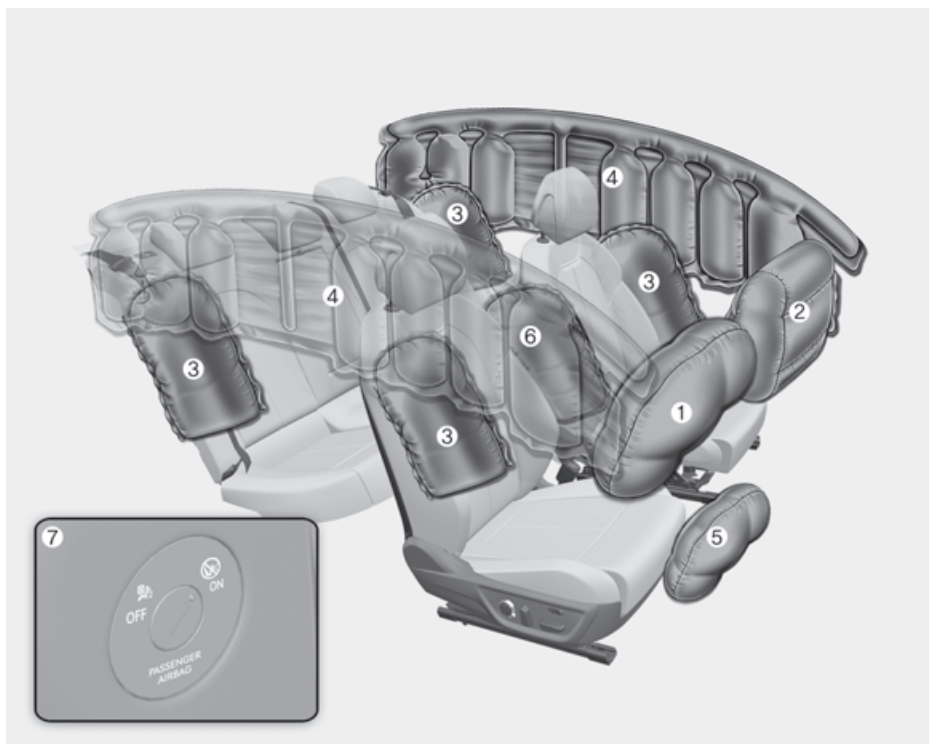

The actual airbags in the vehicle may differ from the illustration.

- (1) Driver's front airbag
- (2) Passenger's front airbag
- (3) Side airbag/rear side airbag (if equipped)
- (4) Curtain airbag
- (5) Driver's knee airbag
- (6) Front center side airbag (if equipped)
- (7) Front passenger airbag ON/OFF switch (if equipped)

This vehicle is equipped with a Supplemental Airbag System for the driver's seat and front passenger's seats.

The front airbags are designed to supplement the three-point seat belts. For these airbags to provide protection, the seat belts must be worn at all times when driving.

You can be severely injured or killed in an accident if you are not wearing a seat belt. Airbags are designed to supplement seat belts, but do not replace them. Also, airbags are not designed to deploy in every collision. In some accidents, the seat belts are the only restraint protecting you.



WARNING

AIRBAG SAFETY PRECAUTIONS

Always use seat belts and Child Restraint Systems - every trip, every time, everyone! Even with airbags, you can be seriously injured or killed in a collision if you are improperly belted or not wearing your seat belt when the airbag inflates.

Never place a child in any Child Restraint System or booster seat in the front passenger seat, unless the airbag is deactivated.

An inflating airbag could forcefully strike the infant or child causing serious or fatal injuries.

ABC - Always Buckle Children under age 13 in the back seat. It is the safest place for children of any age to ride. If a child age 13 or older must be seated in the front seat, he or she must be properly belted and the seat should be moved as far back as possible.

All occupants should sit upright with the seatback in an upright position, centered on the seat cushion with their seat belt on, legs comfortably extended and their feet on the floor until the vehicle is parked and the vehicle is turned off. If an occupant is out of position during an accident, the rapidly deploying airbag may forcefully contact the occupant causing serious or fatal injuries.

You and your passengers should never sit or lean unnecessarily close to the airbags or lean against the door or center console.

Move your seat as far back as possible from front airbags, while still maintaining control of the vehicle.

Where are the airbags?

Driver's and passenger's front airbags

Driver's front airbags

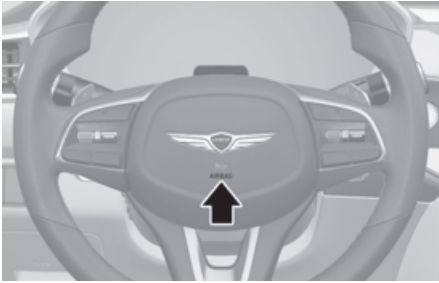

Driver's knee airbag

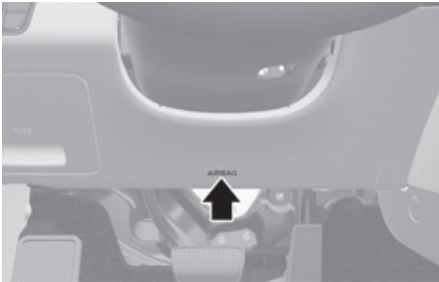

Passenger's front airbag

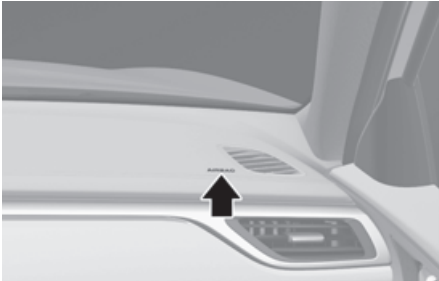

Your vehicle is equipped with a Supplemental Restraint System (SRS) and lap/shoulder belts at both the driver and passenger seating positions.

The SRS consists of airbags which are located in the center of the steering wheel, in the driver's side lower crash pad below the steering wheel, and the passenger's side front panel pad above the glove box.

The airbags are labeled with the letters "AIRBAG" embossed on the pad covers.

The purpose of the SRS is to provide the vehicle's driver and front passengers with additional protection than that offered by the seat belt system alone in case of a frontal impact of sufficient severity.

⚠ WARNING

To reduce the risk of serious injury or death from inflating front airbags, take the following precautions:

- Seat belts must be worn at all times to help keep occupants positioned properly.
- Move your seat as far back as possible from front airbags, while still maintaining control of the vehicle.
- Never lean against the door or center console.
- Do not allow the front passenger to place their feet or legs on the dashboard.
- No objects (such as crash pad cover, mobile phone holder, cup holder, perfume or stickers) should be placed over or near the airbag modules on the steering wheel, instrument panel, windshield glass, and the front passenger's panel above the glove box. Such objects could cause harm if the vehicle is in a crash severe enough to cause the airbags to deploy.
- Do not attach any objects on the front windshield and inside mirror.

Passenger's front airbag ON/OFF switch

 if equipped



The purpose of the switch is to disable the passenger's front airbag in order to transport occupants who are at increased risk for airbag-related injury due to age, size, or medical condition.

To deactivate the passenger's front airbag:

 if equipped



Insert the key or a similar rigid device into the passenger's front airbag ON/OFF switch and turn it to the OFF position. The passenger airbag OFF indicator () will illuminate and stay on until the passenger's front airbag is reactivated.

To reactivate the passenger's front airbag:

 if equipped



Insert the key or a similar rigid device into the passenger's front airbag ON/OFF switch and turn it to the ON position. The passenger airbag ON indicator () will illuminate and go off after about 60 seconds.

i Information

The passenger's front airbag ON/OFF indicator generally illuminates for about 4 seconds after the Engine Start/Stop button is in the ON position. But, if the Engine Start/Stop button is pressed to the ON position within 3 minutes after the engine was turned off, the indicator will not illuminate.

⚠ WARNING

Never allow an adult passenger to ride in the front passenger seat when the passenger airbag OFF indicator is illuminated. During a collision, the airbag will not inflate if the indicator is illuminated. Turn on the passenger's front airbag or have your passenger move to the rear seat.

⚠ WARNING

If the passenger's front airbag ON/OFF switch malfunctions, the following conditions may occur:

- The airbag warning light (⚠) on the instrument cluster will illuminate.
- The passenger airbag OFF indicator (⚠) will not illuminate and the ON indicator (⚠) will come on. The passenger's front airbag will inflate in a frontal impact even though the passenger's front airbag ON/OFF switch is set to the OFF position.
- We recommend that an authorized retailer of Genesis Branded products inspect the passenger's front airbag ON/OFF switch and the SRS airbag system as soon as possible.

Side airbags and front center side airbag

+ if equipped

Side airbags (Front seats)



Side airbags (Rear seat)



Front center side airbag (Driver's seat)



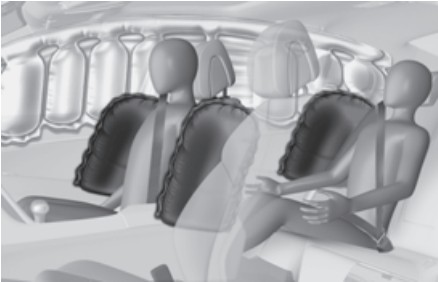

Your vehicle is equipped with a side airbag in each front and outboard second row seat. Additionally, a front center side airbag is provided in the inboard side of the driver seatback. The purpose of the airbag is to provide the vehicle's additional protection than that offered by the seat belt alone.

The side airbags and front center side airbag are designed to deploy during certain side impact collisions, depending on the crash severity.

For vehicles equipped with a rollover sensor the front center side airbag, side and/or curtain airbags and pre-tensioners on both sides of the vehicle may deploy if a rollover or possible rollover is detected.

The side airbags and front center side airbag are not designed to deploy in all side impact or rollover situations.



WARNING

To reduce the risk of serious injury or death from an inflating side airbag and front center side airbag, take the following precautions:

- Seat belts must be worn at all times to help keep occupants positioned properly.
- Do not allow passengers to lean their heads or bodies onto doors, put their arms on the doors, stretch their arms out of the window, or place objects between the doors and seats.

- Hold the steering wheel at the 9 o'clock and 3 o'clock positions, to minimize the risk of injuries to your hands and arms.
 - Do not use any accessory seat covers. This could reduce or prevent the effectiveness of the system.
 - Do not hang other objects except clothes. In an accident it may cause vehicle damage or personal injury especially when airbag is inflated.
 - Do not place any objects over the airbag or between the airbag and yourself. Also, do not attach any objects around the area the airbag inflates such as the door, side door glass, front and rear pillar.
 - Do not place any objects between the door and the seat. They may become dangerous projectiles if the side airbag inflates.
 - Do not install any accessories on the side or near the side airbags.
 - Do not cause impact to the doors when the Engine Start/Stop button is in the ON or START position as this may cause the side airbags to inflate.
 - If the seat or seat cover is damaged, we recommend that the system serviced by an authorized retailer of Genesis Branded products.
-

Curtain airbags



Curtain airbags are located along both sides of the roof rails above the front and rear doors.

They are designed to help protect the heads of the front seat occupants and the rear outboard seat occupants in certain side impact collisions.

The curtain airbags are designed to deploy during certain side impact collisions, depending on the crash severity.

For vehicles equipped with a rollover sensor the side and/or curtain airbags and pre-tensioners on both sides of the vehicle may deploy if a rollover or possible rollover is detected.

The curtain airbags are not designed to deploy in all side impact or rollover situations.

WARNING

To reduce the risk of serious injury or death from an inflating curtain airbag, take the following precautions:

- All seat occupants must wear seat belts at all times to help keep occupants positioned properly.
- Properly secure Child Restraint System as far away from the door as possible.
- Do not place any objects over the airbag. Also, do not attach any objects around the area the airbag inflates such as the door, side door glass, front and rear pillar, roof side rail.
- Do not hang other objects except clothes, especially hard or breakable objects.

In an accident, it may cause vehicle damage or personal injury.

- Do not allow passengers to lean their heads or bodies onto doors, put their arms on the doors, stretch their arms out of the window, or place objects between the doors and seats.
- Do not open or repair the side curtain airbags.

How does the airbags system operate?

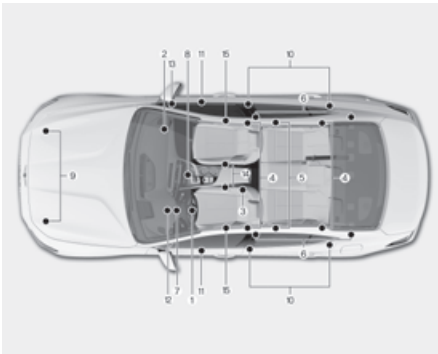

The SRS consists of the following components:

- (1) Driver's front airbag module
- (2) Passenger's front airbag module
- (3) Front center side airbag module (if equipped)
- (4) Front/rear side airbag modules (if equipped)
- (5) Curtain airbag modules
- (6) Front retractor pretensioner/Rear retractor pretensioner (if equipped)
- (7) Airbag warning light
- (8) SRS control module (SRSCM)/Rollover sensor (if equipped)
- (9) Front impact sensors
- (10) Side impact sensors (acceleration)
- (11) Side impact sensors (pressure)
- (12) Driver's knee airbag module
- (13) Front passenger's airbag ON/OFF switch (if equipped)
- (14) Buckle sensor
- (15) Emergency Fastening Device (if equipped)

* Front passenger's airbag ON/OFF lamp is located on the overhead console.

The SRSCM (Supplemental Restraint System Control Module) continually monitors all SRS components while the Engine Start/Stop button is ON to determine if a crash impact is severe enough to require airbag deployment or pretensioner seat belt deployment.

SRS warning light



The SRS (Supplemental Restraint System) airbag warning light on the instrument panel displays the airbag symbol depicted in the illustration. The system checks the airbag electrical system for malfunctions. The light indicates that there is a potential problem with your airbag system, which could include your side and/or curtain airbags used for rollover protection (if equipped with rollover sensor).

WARNING

If your SRS malfunctions, the airbag may not inflate properly during an accident, increasing the risk of serious injury or death.

If any of the following conditions occur, your SRS is malfunctioning:

- The light does not turn on for about three to six seconds when the Engine Start/Stop button is in the ON position.
- The light stays on after illuminating for about three to six seconds.
- The light comes on while the vehicle is in motion.
- The light blinks when the engine is running.

We recommend that an authorized retailer of Genesis Branded products inspect the SRS as soon as possible if any of these conditions occur.

During a moderate to severe frontal collision, sensors will detect the vehicle's rapid deceleration. If the rate of deceleration is high enough, the control unit will inflate the front airbags, at the time and with the force needed.

The front airbags help protect the driver and front passenger by responding to frontal impacts in which seat belts alone cannot provide adequate restraint. When needed, the side airbags help provide protection in the event of a side impact or rollover by supporting the side upper body area.

- Airbags are activated (able to inflate if necessary) Only when the Engine Start/Stop button is in the ON or START position and it can be activated within about 3 minutes after the engine is turned off.
- Airbags inflate in the event of certain frontal or side collisions to help protect the occupants from serious physical injury.
- There is no single speed at which the airbags will inflate. Generally, airbags are designed to inflate based upon the severity of a collision and its direction. These two factors determine whether the sensors produce an electronic deployment/inflation signal.
- The front airbags will completely inflate and deflate in an instant. It is virtually impossible for you to see the airbags inflate during an accident. It is much more likely that you will simply see the deflated airbags hanging out of their storage compartments after the collision.

- In addition to inflating in serious side collisions, vehicles equipped with a rollover sensor, side and/or curtain airbags and front center side airbag will inflate if the sensing system detects a rollover.

When a rollover is detected, curtain airbags will remain inflated longer to help provide protection from ejection, especially when used in conjunction with the seat belts. (if equipped with a rollover sensor)

- To help provide protection, the airbags must inflate rapidly. The speed of airbag inflation is a consequence of extremely short time in which to inflate the airbag between the occupant and the vehicle structures before the occupant impacts those structures. This speed of inflation reduces the risk of serious or life-threatening injuries and is thus a necessary part of airbag design.

However, the rapid airbag inflation can also cause injuries which can include facial abrasions, bruises and broken bones because the inflation speed also causes the airbags to expand with a great deal of force.

- There are even circumstances under which contact with the airbag can cause fatal injuries, especially if the occupant is positioned excessively close to the airbag.

You can take steps to reduce the risk of being injured by an inflating airbag. The greatest risk is sitting too close to the airbag. An airbag needs space to inflate. It is recommended that drivers sit as far as possible between the center of the steering wheel and the chest while still maintaining control of the vehicle.

When the SRSCM detects a sufficiently severe impact to the front of the vehicle, it will automatically deploy the front airbags.

Driver's front airbag (1)



Driver's front airbag (3)



Upon deployment, tear seams molded directly into the pad covers will separate under pressure from the expansion of the airbags. Further opening of the covers allows full inflation of the air bags.

Driver's front airbag (2)



Passenger's front airbag



After complete inflation, the airbag immediately starts deflating, enabling the driver to maintain forward visibility and the ability to steer or operate other controls.

A fully inflated airbag, in combination with a properly worn seat belt, slows the driver's or the front passenger's forward motion, reducing the risk of head and chest injury.

⚠ WARNING

To prevent objects from becoming dangerous projectiles when the passenger's airbag inflates:

- Do not install or place any objects (drink holder, CD holder, stickers, etc.) on the front passenger's panel above the glove box where the passenger's airbag is located.
- Do not install a container of liquid air freshener near the instrument cluster or on the instrument panel surface.

What to expect after an airbag inflates

After a frontal or side airbag inflates, it will deflate very quickly. Airbag inflation will not prevent the driver from seeing out of the windshield or being able to steer. Curtain airbags may remain partially inflated for some time after they deploy.

WARNING

After an airbag inflates, take the following precautions:

- Open your windows and doors as soon as possible after impact to reduce prolonged exposure to the smoke and powder released by the inflating airbag.
- Do not touch the airbag storage area's internal components immediately after an airbag has inflated. The parts that come into contact with an inflating airbag may be very hot.
- Always wash exposed skin areas thoroughly with cold water and mild soap.
- We recommend that an authorized retailer of Genesis Branded products replace the airbag immediately after deployment. Airbags are designed to be used only once.

Noise and smoke from inflating airbag

When the airbags inflate, they make a loud noise and may produce smoke and powder in the air inside of the vehicle. This is normal and is a result of the ignition of the airbag inflator. After the airbag inflates, you may feel substantial discomfort in breathing because of the contact of your chest with both the seat belt and the airbag, as well as from breathing the smoke and powder. The powder may aggravate asthma for some people. If you experience breathing problems after an air bag deployment, seek medical attention immediately.

Though the smoke and powder are nontoxic, they may cause irritation to the skin, eyes, nose, throat, etc. If this is the case, wash and rinse with cold water immediately and seek medical attention if the symptoms persist.

Do not install a Child Restraint System on the front passenger seat

Type A



Type B

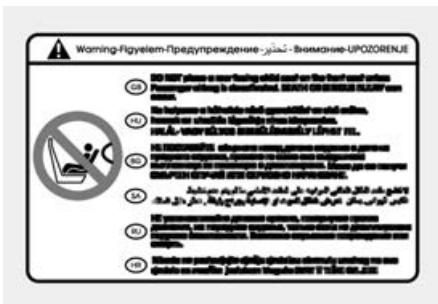

Never install a Child Restraint System in the front passenger seat, unless the airbag is deactivated.

! WARNING

Never use a rearward facing Child Restraint on a seat protected by an ACTIVE AIRBAG in front of it, DEATH or SERIOUS INJURY to the CHILD can occur.

Why didn't my airbag go off in a collision?

There are certain types of accidents in which the airbag would not be expected to provide additional protection. These include rear impacts, second or third collisions in multiple impact accidents, as well as low speed impacts. Damage to the vehicle indicates a collision energy absorption, and is not an indicator of whether or not an airbag should have inflated.

Airbag collision sensors

! WARNING

To reduce the risk of an airbag deploying unexpectedly and causing serious injury or death:

- Do not hit or allow any objects to impact the locations where airbags or sensors are installed.
- Do not perform maintenance on or around the airbag sensors. If the location or angle of the sensors is altered, the airbags may deploy when they should not or may not deploy when they should.
- Installing bumper guards with non-genuine Genesis or non-equivalent parts may adversely affect the collision and airbag deployment performance.

To ensure correct function of the airbag system, we recommend to replace the bumper with genuine Genesis part or the equivalent (of the genuine part) specified for your vehicle.

- Press the Engine Start/Stop button to the OFF or ACC position and wait for 3 minutes, when the vehicle is being towed to prevent inadvertent airbag deployment.
- We recommend that all airbag repairs be conducted by an authorized retailer of Genesis Branded products.

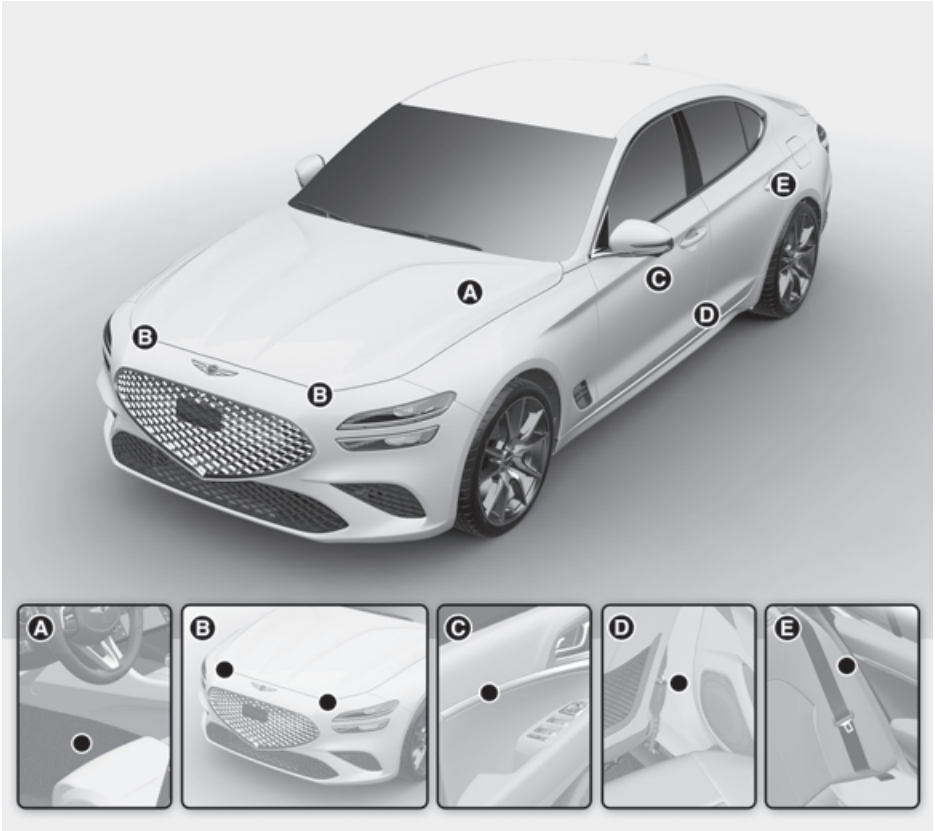

- [A] SRS control module/Rollover sensor (if quipped)
- [B] Front impact sensor
- [C] Side impact sensor (pressure)
- [D] Side impact sensor (acceleration): B-pillar
- [E] Side impact sensor (acceleration): C-pillar

Airbag inflation conditions

Front airbags



Front airbags are designed to inflate in a frontal collision depending on the severity of impact of the front collision.

Side and curtain airbags and front center side airbag

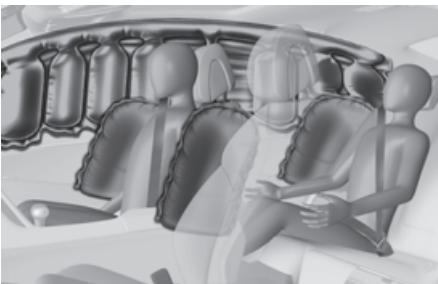

Side and curtain airbags and the front center side airbag are designed to inflate when an impact is detected by side collision sensors depending on the severity of impact resulting from a side impact collision.

Although the driver's and front passenger's airbags are designed to inflate in frontal collisions, they also may inflate in other types of collisions if the front impact sensors detect a sufficient impact. Side and curtain airbags and the front center side airbag are designed to inflate in side impact collisions, but they may inflate in other collisions if the side impact sensors detect a sufficient impact.

Also, the side and curtain airbags and the front center side airbag are designed to inflate when a rollover is detected by a rollover sensor (if equipped with rollover sensor).

If the vehicle chassis is impacted by bumps or objects on unimproved roads, the airbags may deploy. Drive carefully on unimproved roads or on surfaces not designed for vehicle traffic to prevent unintended airbag deployment.

Airbag non-inflation conditions

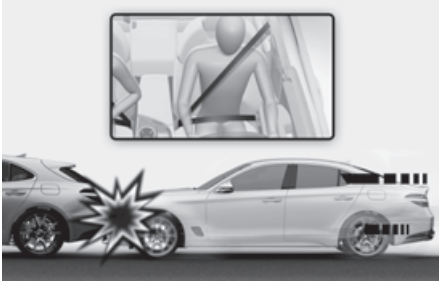

In certain low-speed collisions the airbags may not deploy. The airbags are designed not to deploy in such cases because they may not provide benefits beyond the protection of the seat belts.



Front airbags are not designed to inflate in rear collisions, because occupants are moved backward by the force of the impact. In this case, inflated airbags would not provide any additional benefit.

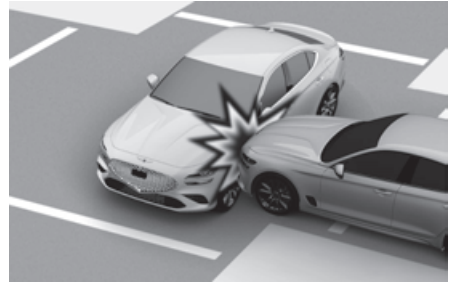

Front airbags may not inflate in side impact collisions, because occupants move in the direction of the collision, and thus in side impacts, front airbag deployment would not provide additional occupant protection.

However, side and curtain airbags and the front center side airbag may inflate depending on the severity of impact.

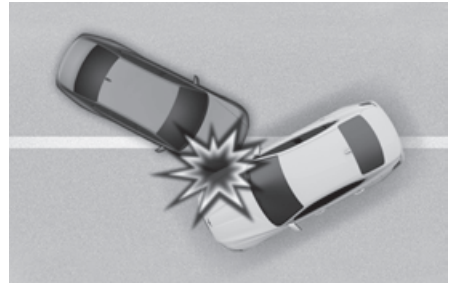

In an angled collision, the force of impact may direct the occupants in a direction where the air bags would not be able to provide any additional benefit, and thus the sensors may not deploy any airbags.

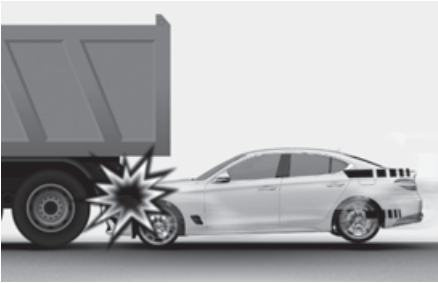

Just before impact, drivers often brake heavily. Such heavy braking lowers the front portion of the vehicle causing it to “ride” under a vehicle with a higher ground clearance. Airbags may not inflate in this “underride” situation because deceleration forces that are detected by sensors may be significantly reduced by such “underride” collisions.

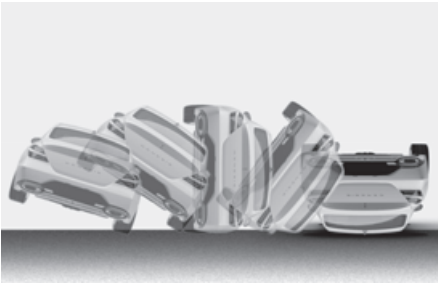

Front airbags may not inflate in rollover accidents because front airbag deployment would not provide additional occupant protection.

i Information

With rollover sensor

The side and curtain airbags and the front center side airbag may inflate in a rollover situation, when it is detected by the rollover sensor.

i Information

Without rollover sensor

The side and/or curtain airbags and the front center side airbag may inflate when the vehicle is rolled over by a side impact collision, if the vehicle is equipped with side and/or curtain air bags.



Airbags may not inflate if the vehicle collides with objects such as utility poles or trees, where the point of impact is concentrated and the collision energy is absorbed by the vehicle structure.

SRS care

The SRS is virtually maintenance-free and there are no parts you can safely service by yourself. If the SRS airbag warning light does not illuminate when the Engine Start/Stop button is in the ON position, or continuously remains on, we recommend that the system be immediately inspected by an authorized retailer of Genesis Branded products.

We recommend any work on the SRS system, such as removing, installing, repairing, or any work on the steering wheel, the front passenger's panel, front seats and roof rails be performed by an authorized retailer of Genesis Branded products. Improper handling of the SRS system may result in serious personal injury.

WARNING

To reduce the risk of serious injury or death take the following precautions:

- Do not attempt to modify or disconnect the SRS components or wiring, including the addition of any kind of badges to the pad covers or modifications to the body structure.
- Do not place objects over or near the airbag modules on the steering wheel, instrument panel, and the front passenger's panel above the glove box.
- Clean the airbag pad covers with a soft cloth moistened with plain water. Solvents or cleaners could adversely affect the airbag covers and proper deployment of the system.
- We recommend that inflated airbags replaced by an authorized retailer of Genesis Branded products.
- If components of the airbag system must be discarded, or if the vehicle must be scrapped, certain safety precautions must be observed. We recommend that you consult an authorized retailer of Genesis Branded products for the necessary information. Failure to follow these precautions could increase the risk of personal injury.

Additional safety precautions

Passengers should not move out of or change seats while the vehicle is moving. A passenger who is not wearing a seat belt during a crash or emergency stop can be thrown against the inside of the vehicle, against other occupants, or be ejected from the vehicle.

Do not use any accessories on seat belts.

Devices claiming to improve occupant comfort or reposition the seat belt can reduce the protection provided by the seat belt and increase the chance of serious injury in a crash.

Do not modify the front seats.

Modification of the front seats could interfere with the operation of the supplemental restraint system sensing components or side airbags.

Do not place items under the front seats.

Placing items under the front seats could interfere with the operation of the supplemental restraint system sensing components and wiring harnesses.

Do not cause impact to the doors.

Impact to the doors when the Engine Start/Stop button is in the ON or START position may cause the airbags to inflate.

Adding equipment to or modifying your airbag equipped vehicle

If you modify your vehicle by changing your vehicle's frame, bumper system, front end or side sheet metal or ride height, this may affect the operation of your vehicle's airbag system.

Airbag warning labels



Airbag warning labels are attached to alert the passengers of potential risks of the airbag system.

Be sure to read all of the information about the airbags that are installed on your vehicle in this Owner's Manual.

Active hood lift system

+ if equipped

The active hood lift system can reduce a risk of injury to pedestrians by raising the hood in certain accident situations. The active hood lift system has the additional deformation space under the hood, which is made available for subsequent head impact.

System activation

Prerequisite for activation

The Engine Start/Stop button is in the START position and the vehicle speed is between about 25 km/h (15.5 mph) and 50 km/h (31 mph).

i Information

Active hood lift system repair

- If the active hood lift system has been activated, do not place the hood back by yourself. We recommend that the system be repaired by an authorized retailer of Genesis Branded products.
- If you change or repair the front bumper, we recommend that the system be checked by an authorized retailer of Genesis Branded products.

System activation

The active hood lift system is designed to work in a frontal collision depending on the intensity, speed or angles of impact of the front collision

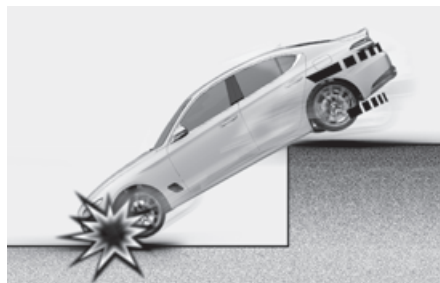
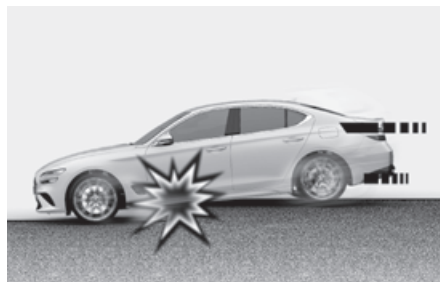

The system may activate when:

- The vehicle falls in the gutter or from a high place
- An impact is detected by a frontal collision without pedestrians in front.
- Certain high-speed frontal or angled collision with a vehicle or barrier.

System limitation

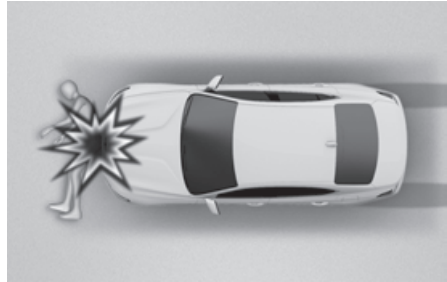
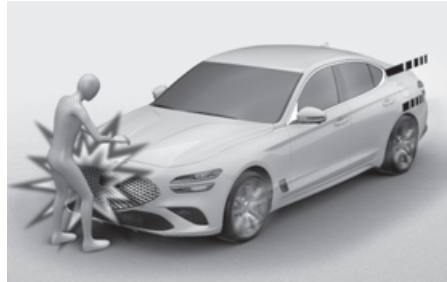
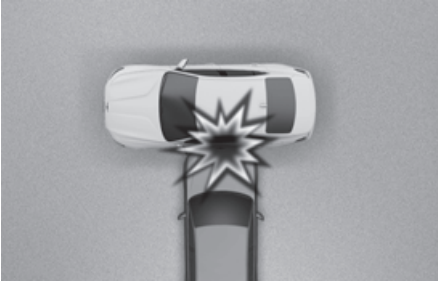

The system will not activate when:

- On side collisions, rear collision, and rollover accident. The vehicle can detect only frontal collision.
- The front bumper is damaged or modified.
- The vehicle is in an angled frontal collision with pedestrians.
- A pedestrian is laying on the road.
- A pedestrian has an object to absorb the shock such as a suit case, buggy or cart.

System malfunction

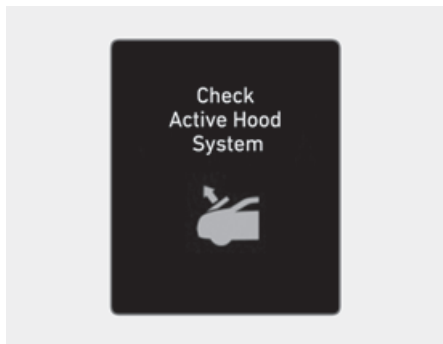

If there is a problem with the system a message will appear on the cluster display.

This warning message means that the protection of pedestrians by the active hood lift system is not working properly.

If the warning message appears, we recommend that the system be checked as soon as possible by an authorized retailer of Genesis Branded products.

i Information

- Do not remove or change the components and the wiring of the active hood system.
- Do not change the front bumper or the body structure.
- Do not install or assemble any aftermarket accessory on the front bumper or cover.
- When replacing tires, make sure they are the same size as your original tires. If you drive with different tire or wheel sizes, the active hood lift system may not work normally.

The above situations may cause a malfunction of the active hood lift system.

4. Instrument cluster

Instrument cluster	4-2
Instrument cluster control.....	4-3
Gauges and meters.....	4-4
Transmission shift indicator	4-10
Warning and indicator lights	4-11
Cluster display messages.....	4-29
Cluster display (Type A)	4-35
Cluster display control.....	4-35
View modes.....	4-35
Option menu	4-41
Cluster display (Type B)	4-43
Cluster display control.....	4-43
View modes.....	4-44
Trip computer.....	4-47
3D instrument cluster (for 12.3-inch 3D cluster)	4-50
Vehicle (infotainment system).....	4-53
Setting your vehicle	4-53

Instrument cluster

8-inch

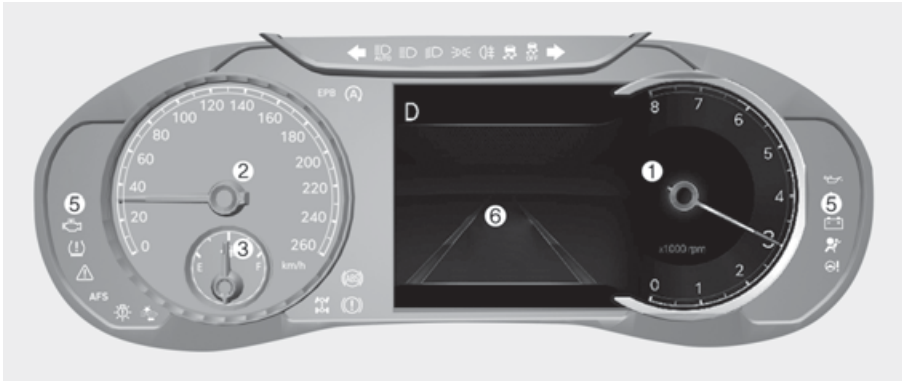

12.3-inch 3D



**The actual cluster in the vehicle may differ from the illustration.
For more information, refer to the “Gauges and meters” section in this chapter.**

- (1) Tachometer
- (2) Speedometer
- (3) Fuel gauge
- (4) Engine coolant temperature gauge
- (5) Warning and indicator lights
- (6) Cluster display

i Information

Detailed information on 3D instrument cluster is provided later in this chapter.

Instrument cluster control

Instrument panel illumination

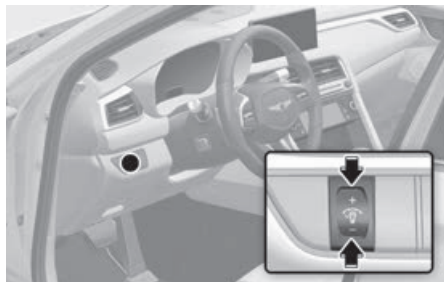

When the vehicle's position lights or headlights are on, press the illumination control switch to adjust the brightness of the instrument panel illumination.

When pressing the illumination control switch, the interior switch illumination intensity is also adjusted.

WARNING

Never adjust the instrument cluster while driving. This could result in loss of control and lead to an accident that may cause death, serious injury, or vehicle damage.

Type A

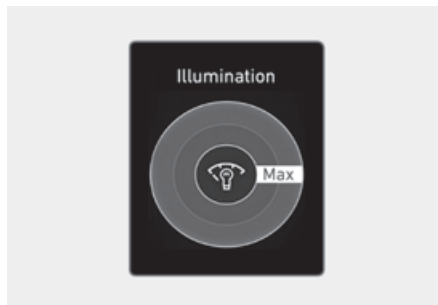

Type B



- The brightness of the instrument panel illumination appears.
- If the brightness reaches the maximum or minimum level, a chime will sound.

Gauges and meters

Speedometer

8-inch (km/h)



8-inch (km/h, MPH)



8-inch (MPH, km/h)



12.3-inch 3D (km/h)



12.3-inch 3D (MPH)

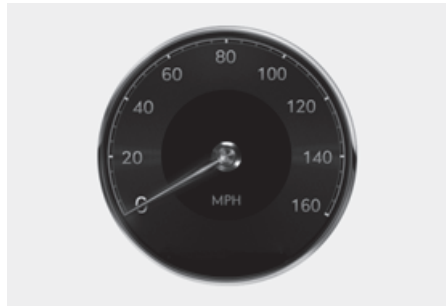

The speedometer indicates the speed of the vehicle and is calibrated in kilometers per hour (km/h) and/or miles per hour (MPH).

Tachometer

8-inch (Gasoline engine)



8-inch (Diesel engine)



12.3-inch 3D (Gasoline engine)



12.3-inch 3D (Diesel engine)



The tachometer indicates the approximate number of engine revolutions per minute (rpm).

Use the tachometer to select the correct shift points and to prevent lugging and/or over-revving the engine.

NOTICE

Do not operate the engine within the tachometer's RED ZONE. This may cause severe engine damage.

**Engine coolant temperature gauge
(for 12.3-inch 3D cluster)**

Type A



Type B



This gauge indicates the temperature of the engine coolant when the Engine Start/Stop button is in the ON position.

NOTICE

If the gauge pointer moves beyond the normal range area toward the “H (Hot) or 130” position, it indicates overheating that may damage the engine.

Do not continue driving with an overheated engine. If your vehicle overheats, refer to the “If the engine overheats” section in chapter 8.

WARNING

Never remove the engine coolant reservoir cap when the engine is hot. The engine coolant is under pressure and could cause severe burn. Wait until the engine is cool before adding coolant to the reservoir.

i Information

Type A

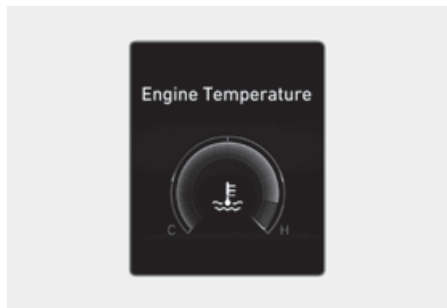

Type B

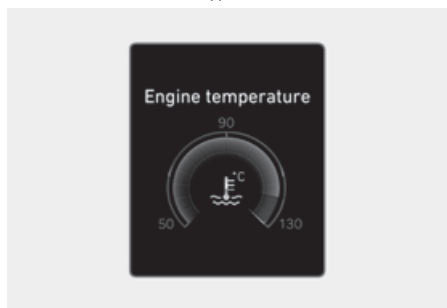

For 8-inch instrument cluster, you can check the engine coolant temperature in the Utility view on the cluster.

Refer to the “Cluster display (Type A)”, “Cluster display (Type B)” section in chapter 4.

Fuel gauge

8-inch (Type A)



8-inch (Type B)



12.3-inch 3D (Type A)

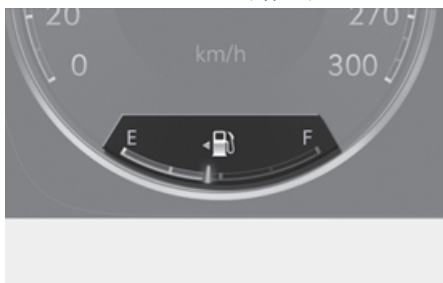

12.3-inch 3D (Type B)

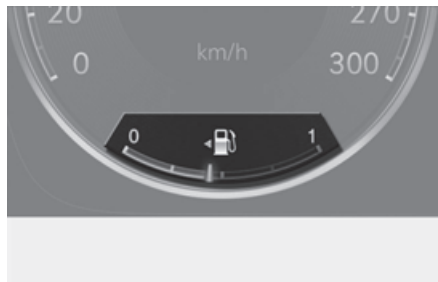

This gauge indicates the approximate amount of fuel remaining in the fuel tank.

***i* Information**

- The fuel tank capacity is given in chapter 2.
- The fuel gauge is supplemented by a low fuel warning light, which will illuminate when the fuel tank is nearly empty.
- On inclines or curves, the fuel gauge pointer may fluctuate or the low fuel warning light may come on earlier than usual due to the movement of fuel in the tank.

WARNING

Running out of fuel can expose vehicle occupants to danger.

You must stop and obtain additional fuel as soon as possible after the warning light comes on or when the gauge indicator comes close to the “E (Empty) or 0” level.

NOTICE

Avoid driving with an extremely low fuel level. Running out of fuel could cause the engine to misfire damaging the catalytic converter.

Outside temperature gauge

8-inch



12-3 inch 3D

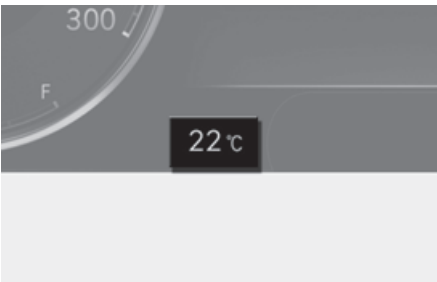

This gauge indicates the current outside air temperatures by 1°C (1°F).

Note that the temperature indicated on the cluster display may not change as quickly as the outside temperature (there may be a slight delay before the temperature changes.)

You can change the temperature unit from the Settings menu in the infotainment system. Select:

- **Setup (Settings) > General > Units > Temperature > °C/°F**

i Information

The infotainment system may change after software updates. For more information, refer to the manual provided in the infotainment system and the quick reference guide.

For vehicles equipped with Automatic Climate Control, you can also:

- Press the AUTO button while pressing the OFF button on the climate control unit for 3 seconds

Both the temperature unit on the cluster display and climate control screen will change.

Odometer

8-inch

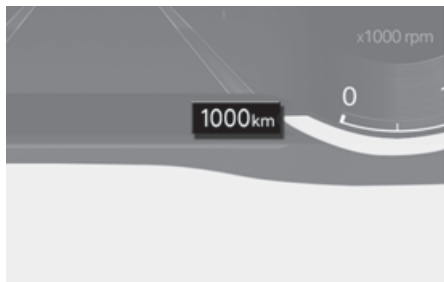

12-3 inch 3D

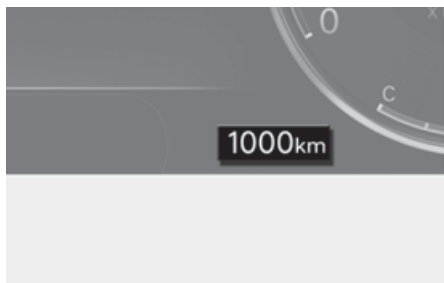

The odometer indicates the total distance that the vehicle has been driven and should be used to determine when periodic maintenance should be performed.

Distance to empty

8-inch



12.3-inch 3D

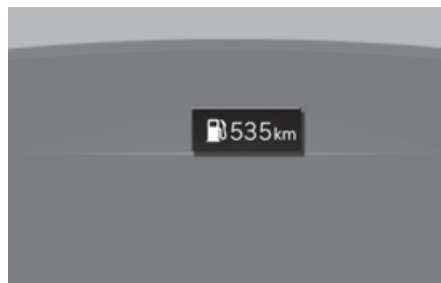

- The distance to empty is the estimated distance the vehicle can be driven with the remaining fuel.
- If the estimated distance is below 1 km (1 mi.), the trip computer will display "---" as distance to empty.

i Information

- If the vehicle is not on level ground or the battery power has been interrupted, the distance to empty function may not operate correctly.
- The distance to empty may differ from the actual driving distance as it is an estimate of the available driving distance.
- The trip computer may not register additional fuel if less than 6 liters (1.5 gallon) of fuel are added to the vehicle.
- The distance to empty may vary significantly based on driving conditions, driving habits, and condition of the vehicle.

Transmission shift indicator

Automatic transmission shift indicator

 If equipped

8-inch



12.3-inch 3D

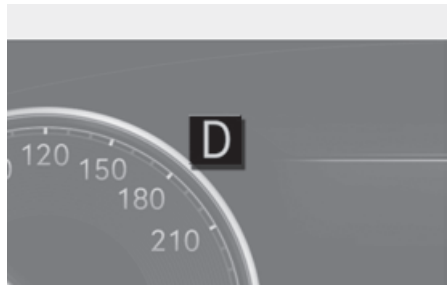

This indicator informs the current gear engaged.

Automatic transmission shift indicator in Manual Shift mode (For Europe)

 if equipped

8-inch



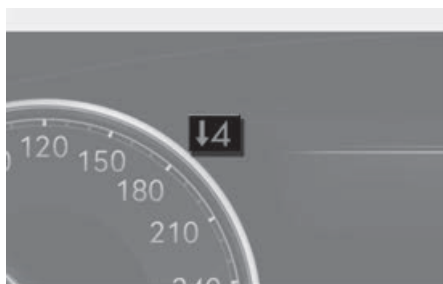

12.3-inch



In the Manual Shift mode, this indicator informs which gear is recommended while driving, to save fuel.

For example

 3: Indicates that shifting up to the 3rd gear is recommended (currently the vehicle is in the 2nd or 1st gear).

 3: Indicates that shifting down to the 3rd gear is recommended (currently the vehicle is in the 4th, 5th, or 6th gear).

When the system is not working properly, the indicator is not displayed.

Warning and indicator lights

Information

Make sure that all warning lights are OFF after starting the engine. If any light is still ON, this indicates a situation that needs attention.

Seat belt warning light



This warning light informs the driver that the seat belt is not fastened.

For more information, refer to the “Seat belts” section in chapter 3.

Airbag warning light



This warning light illuminates:

- When the Engine Start/Stop button is in the ON position. It illuminates for 3-6 seconds and then goes off.
 - The airbag warning light illuminates for about 6 seconds and then turns off when all checks have been performed.
- The airbag warning light will remain illuminated if there is a malfunction with the Safety Restraint System (SRS) airbag operation.

If this occurs, we recommend that you have the vehicle inspected by an authorized retailer of Genesis Branded products.

Parking brake & Brake fluid warning light



This warning light illuminates:

- When the Engine Start/Stop button is in the ON position. It illuminates for about 3 seconds and then goes off once the parking brake is released.
- Whenever the parking brake is applied.
- Whenever the brake fluid level in the reservoir is low.
 - If the warning light illuminates with the parking brake released, it indicates the brake fluid level in the reservoir is low.

If the brake fluid level in the reservoir is low:

1. Drive carefully to the nearest safe location and stop your vehicle.
2. With the engine stopped, check the brake fluid level immediately and add fluid as required (For more information, refer to the “Brake fluid” section in chapter 9). After adding brake fluid, check all brake components for fluid leaks. If a brake fluid leak is found, or if the warning light remains on, or if the brakes do not operate properly, do not drive the vehicle. We recommend that your the vehicle be inspected by an authorized retailer of Genesis Branded products.

Dual-diagonal braking system

Your vehicle is equipped with dual-diagonal braking system. This means you still have braking on two wheels even if one of the dual systems should fail.

With only one of the dual systems working, more than normal pedal travel and greater pedal pressure is required to stop the vehicle.

Also, the vehicle will not stop in as short a distance with only a portion of the brake system working.

If the brakes fail while you are driving, shift to a lower gear for additional engine braking and stop the vehicle as soon as it is safe to do so.

! WARNING

Parking Brake & Brake Fluid warning light

Driving the vehicle with a warning light ON is dangerous. If the Parking Brake & Brake Fluid warning light illuminates with the parking brake released, it indicates that the brake fluid level is low.

If this occurs, we recommend that you have the vehicle inspected by an authorized retailer of Genesis Branded products.

Anti-lock Brake System (ABS) warning light



This warning light illuminates:

- When the Engine Start/Stop button is in the ON position. It illuminates for about 3 seconds and then goes off.
- Whenever there is a malfunction with the ABS.

Note that the hydraulic braking system will still be operational even if there is a malfunction with the ABS.

If this occurs, we recommend that you have the vehicle inspected by an authorized retailer of Genesis Branded products.

Electronic Brake Force Distribution (EBD) system warning light



When the ABS warning and Parking Brake warning lights are on simultaneously, it may indicate a problem with the Electronic Brake Force Distribution system.

If this occurs, we recommend that you have the vehicle inspected by an authorized retailer of Genesis Branded products.

! WARNING

Electronic Brake Force Distribution (EBD) system warning light

When both ABS and Parking Brake & Brake Fluid warning lights are on, the brake system will not work normally and you may experience an unexpected and dangerous situation during sudden braking.

If this occurs, avoid high speed driving and abrupt braking.

We recommend that you have the vehicle inspected by an authorized retailer of Genesis Branded products as soon as possible.

NOTICE

Electronic Brake Force Distribution (EBD) system warning light

When the ABS warning light is on or both ABS and Parking Brake & Brake Fluid warning lights are on, the speedometer, odometer, or tripmeter may not work. Also, the MDPS warning light may illuminate and the steering effort may increase or decrease.

If this occurs, we recommend that you have the vehicle inspected by an authorized retailer of Genesis Branded products as soon as possible.

Motor Driven Power Steering (MDPS) warning light



This warning light illuminates:

- When the Engine Start/Stop button is in the ON position. It illuminates for about 3 seconds and then goes off.
- Whenever there is a malfunction with the Motor Driven Power Steering.
If this occurs, we recommend that you have the vehicle inspected by an authorized retailer of Genesis Branded products.

Charging system warning light



This warning light illuminates:

When there is a malfunction with either the alternator or electrical charging system.

If there is a malfunction with either the alternator or electrical charging system:

1. Drive carefully to the nearest safe location and stop your vehicle.
2. Turn the engine off and check the alternator drive belt for looseness or breakage.

If the belt is adjusted properly, there may be a problem in the electrical charging system.

If this occurs, we recommend that you have the vehicle inspected by an authorized retailer of Genesis Branded products as soon as possible.

Engine oil pressure warning light**This warning light illuminates:**

When the engine oil pressure is low.

If the engine oil pressure is low:

1. Drive carefully to the nearest safe location and stop your vehicle.
2. Turn the engine off and check the engine oil level (For more information, refer to the “Engine oil” section in chapter 9). If the level is low, add oil as required.

If the warning light remains on after adding oil or if oil is not available, we recommend that you have the vehicle inspected by an authorized retailer of Genesis Branded products as soon as possible.

***i* Information**

When engine oil pressure decreases due to insufficient engine oil, etc., the Engine Oil Pressure warning light will illuminate. In addition, the enhanced engine protection system which limits engine power will be activated. If the engine oil pressure is restored, the warning light and the enhanced engine protection system will turn off after the engine is restarted.

NOTICE

If the engine does not stop immediately after the Engine Oil Pressure warning light is illuminated, severe damage could result.

Engine coolant temperature warning light (for 8-inch cluster)**The warning light illuminates:**

When the temperature of the engine coolant is extremely high.

Do not continue driving with an overheated engine. If your vehicle overheats, refer to the “If the engine overheats” section in chapter 8.

NOTICE

If the Engine Coolant Temperature warning light illuminates, it indicates overheating that may damage the engine.

Low fuel level warning light**This warning light illuminates:**

When the fuel tank is nearly empty.
Add fuel as soon as possible.

NOTICE

Driving with the Low Fuel Level warning light on or with the fuel level below “E or 0” can cause the engine to misfire and damage the catalytic converter.

Malfunction Indicator Lamp (MIL)



This indicator light illuminates:

- When the Engine Start/Stop button is in the ON position. It illuminates for about 3 seconds and then goes off.
- Whenever there is a malfunction with either the emission control system or the engine or the vehicle powertrain.
If this occurs, we recommend that you have the vehicle inspected by an authorized retailer of Genesis Branded products.

NOTICE

- Driving with the Malfunction Indicator Lamp (MIL) on may cause damage to the emission control system which could affect drivability and/or fuel economy.
 - If the enhanced engine protection system becomes activated due to lack of engine oil, engine power will be limited. If such condition continues repeatedly, the Malfunction Indicator Lamp will illuminate.
-

NOTICE

- Gasoline engine
If the Malfunction Indicator Lamp (MIL) illuminates, potential catalytic converter damage is possible which could result in loss of engine power.
If this occurs, we recommend that you have the vehicle inspected by an authorized retailer of Genesis Branded products as soon as possible.
 - Diesel engine
If the Malfunction Indicator Lamp (MIL) blinks, an error related to the engine control system may have occurred which could result in loss of engine power, combustion noise and poor emission.
If this occurs, we recommend that you have the vehicle inspected by an authorized retailer of Genesis Branded products.
-

NOTICE

Diesel engine with DPF

When the Malfunction Indicator Lamp (MIL) blinks, it may stop blinking after driving the vehicle:

- at more than 60km/h (37 mph), or
- at more than 2nd gear with 1,250-2,500 engine rpm for a certain time (for about 25 minutes).

If the Malfunction Indicator Lamp (MIL) continues to blink in spite of the procedure, we recommend that you have the DPF system checked by an authorized retailer of Genesis Branded products.

If you continue to drive with the Malfunction Indicator Lamp (MIL) blinking for a long time, the DPF system can be damaged and fuel consumption can worsen.

Fuel filter warning light (for diesel engine)



This warning light illuminates:

When water has accumulated inside the fuel filter.

If this occurs, we recommend an authorized retailer of Genesis Branded products remove water from the fuel filter.

For more information, refer to the "Fuel filter (for diesel engine)" section in chapter 9.

NOTICE

- When the Fuel Filter warning light illuminates, engine power (vehicle speed & idle speed) may decrease.
- If you keep driving with the warning light on, engine parts (injector, common rail, high pressure fuel pump) may be damaged. If this occurs, we recommend that you have the vehicle inspected by an authorized retailer of Genesis Branded products as soon as possible.

Exhaust system (GPF) warning light (for gasoline engine)

 if equipped



- This warning light illuminates, when accumulated soot reaches a certain amount.
- When this warning light illuminates, it may turn off after driving the vehicle at more than 80 km/h (50 mph) for about 30 minutes (above 3rd gear with 1,500 - 4,000 engine rpm).

If this warning light blinks in spite of the procedure (at this time cluster warning message appears), we recommend that you have the GPF system checked by an authorized retailer of Genesis Branded products.

NOTICE

If you continue to drive with the GPF warning light blinking for a long time, the GPF system can be damaged and fuel consumption can worsen.

Exhaust system (DPF) warning light (for diesel engine)

 if equipped



- This warning light illuminates when there is a malfunction with the Diesel Particulate Filter (DPF) system.
- When this warning light illuminates, it may turn off after driving the vehicle at more than 60 km/h (37 mph) for about 30 minutes (above 2nd gear with 1,500-2,500 engine rpm).

If this warning light blinks in spite of the procedure (at this time cluster warning message appears), we recommend that you have the DPF system checked by an authorized retailer of Genesis Branded products.

NOTICE

If you continue to drive with the DPF warning light blinking for a long time, the DPF system can be damaged and fuel consumption can worsen.

SCR warning light (for diesel engine)

 if equipped



This warning light illuminates:

When the urea solution tank is nearly empty.

If the urea solution tank is nearly empty, refill urea solution as soon as possible.

For more information, refer to the "Adding urea solution" section in chapter 9.

Master warning light



This warning light illuminates:

When there is a malfunction in operation in any of the following systems:

- Forward Collision-Avoidance Assist malfunction (if equipped)
- Forward Collision-Avoidance Assist radar blocked (if equipped)
- Blind-Spot Collision-Avoidance Assist malfunction (if equipped)
- Blind-Spot Collision-Avoidance Assist radar blocked (if equipped)
- LED headlight malfunction (if equipped)
- High Beam Assist malfunction (if equipped)
- Smart Cruise Control malfunction (if equipped)
- Smart Cruise Control radar blocked (if equipped)
- Tire Pressure Monitoring System (TPMS) malfunction

To identify the details of the warning, look at the cluster display.

Electronic Parking Brake (EPB) warning light

EPB

This warning light illuminates:

- When the Engine Start/Stop button is in the ON position. It illuminates for about 3 seconds and then goes off.
- Whenever there is a malfunction with EPB.

If this occurs, we recommend that you have the vehicle inspected by an authorized retailer of Genesis Branded products.

***i* Information**

The Electronic Parking Brake (EPB) warning light may illuminate when the Electronic Stability Control (ESC) indicator light comes on to indicate that ESC is not working properly. This does not indicate malfunction of EPB.

Low tire pressure warning light



This warning light illuminates:

- When the Engine Start/Stop button is in the ON position. It illuminates for about 3 seconds and then goes off.
- When one or more of your tires are significantly underinflated. (The location of the underinflated tires appears on the cluster display.)

For more information, refer to the “Tire Pressure Monitoring System (TPMS)” section in chapter 8.

This warning light remains ON after blinking for about 60 seconds, or repeatedly blinks ON and OFF in 3 second intervals:

When there is a malfunction with the TPMS.

If this occurs, we recommend that you have the vehicle inspected by an authorized retailer of Genesis Branded products as soon as possible.

For more information, refer to the “Tire Pressure Monitoring System (TPMS)” section in chapter 8.

 **WARNING**

Safe Stopping

- The TPMS cannot alert you to severe and sudden tire damage caused by external factors.
- If you notice any vehicle instability, immediately take your foot off the accelerator pedal, apply the brakes gradually with light force, and slowly move to a safe position off the road.

Forward Safety warning light

 if equipped



This warning light illuminates:

- When the Engine Start/Stop button is in the ON position. It illuminates for about 3 seconds and then goes off.
- Yellow: When Forward Safety of Forward Collision-Avoidance Assist is deselected, disabled, or a malfunction is detected.

If the yellow warning light remains on after the sensor has been uncovered or unblocked when Forward Safety is set, we recommend that your vehicle be inspected an authorized retailer of Genesis Branded products.

This warning light blinks:

- Red: When Forward Safety function is operating.

For more information, refer to the “Forward Collision-Avoidance Assist (FCA) (Sensor fusion)” section in chapter 7.

Lane Safety indicator light

 if equipped



This indicator light illuminates:

- When the Engine Start/Stop button is in the ON position. It illuminates for about 3 seconds and then goes off.
- Grey: When Lane Keeping Assist operating conditions are not satisfied.
- Green: When Lane Keeping Assist operating conditions are satisfied.
- Yellow: When Lane Safety is deselected, disabled, or a malfunction is detected.

If the yellow warning light remains on after the sensor has been uncovered or unblocked when Lane Safety is set, we recommend that your vehicle be inspected by an authorized retailer of Genesis Branded products.

This indicator light blinks:

- Green: When Lane Keeping Assist is operating.

For more information, refer to the “Lane Keeping Assist (LKA)” section in chapter 7.

Lane Following Assist indicator light**+** if equipped**This indicator light illuminates:**

- When the Engine Start/Stop button is in the ON position. It illuminates for about 3 seconds and then goes off.
- Green: When Lane Following Assist is operating.
- Grey: When Lane Following Assist operating conditions are not satisfied.

This indicator light blinks:

- White: When the steering wheel assist is cancelled.

For more information, refer to the "Lane Following Assist (LFA)" section in chapter 7.

Overspeed warning light**+** if equipped

120
km/h

This warning light blinks:

- When you drive the vehicle more than 120 km/h.
- This is to prevent you from driving your vehicle with overspeed.
- The overspeed warning chime also sound for about 5 seconds.

All Wheel Drive (AWD) warning light**+** if equipped**This warning light illuminates:**

Whenever there is a malfunction with the AWD system.

If this occurs, we recommend that you have the vehicle inspected by an authorized retailer of Genesis Branded products.

For more information, refer to the "All Wheel Drive (AWD)" section in chapter 6.

Intelligent Front-Lighting System warning light**+** if equipped

AFS

This warning light illuminates:

- When the Engine Start/Stop button is in the ON position. It illuminates for about 3 seconds and then goes off.
- Whenever there is a malfunction with Intelligent Front-Lighting System.

If this occurs, drive your vehicle to the nearest safe location, and turn the engine off and restart the engine. If the warning light remains on, we recommend that you have the vehicle inspected by an authorized retailer of Genesis Branded products.

For more information, refer to the "Intelligent Front-Lighting System (IFS)" section in chapter 5.

LED headlight warning light

 if equipped



This warning light illuminates:

- When you set the Engine Start/Stop button to the ON position. The LED headlight warning light illuminates for about 3 seconds and then goes off.
- Whenever there is a malfunction with the LED headlight.

If this occurs, we recommend that you have the vehicle inspected by an authorized retailer of Genesis Branded products.

This warning light blinks:

Whenever there is a malfunction with a LED headlight related part.

If this occurs, we recommend that you have the vehicle inspected by an authorized retailer of Genesis Branded products.

NOTICE

Continuous driving with the LED Headlight warning light on or blinking can reduce LED headlight life.

Icy road warning light

 if equipped



This warning light is to warn the driver the road may be icy.

When the temperature on the outside temperature gauge is about below 4°C (40°F), the Icy Road warning light and Outside Temperature Gauge blinks and then illuminates. Also, the warning chime sounds 1 time.

You can activate or deactivate Icy Road Warning function from the Settings menu in the infotainment system. Select:

- **Setup (Settings) > Vehicle > Cluster > Content Selection > Icy Road Warning**

***i* Information**

The infotainment system may change after software updates. For more information, refer to the manual provided in the infotainment system and the quick reference guide.

***i* Information**

If the Icy Road warning light appears while driving, you should drive more attentively and safely refraining from over-speeding, rapid acceleration, sudden braking or sharp turning, etc.

Electronic Stability Control (ESC) indicator light



This indicator light illuminates:

- When the Engine Start/Stop button is in the ON position. It illuminates for about 3 seconds and then goes off.
- Whenever there is a malfunction with ESC system.

If this occurs, we recommend that you have the vehicle inspected by an authorized retailer of Genesis Branded products.

This indicator light blinks:

While ESC is operating.

For more information, refer to the “Electronic Stability Control (ESC)” section in chapter 6.

Electronic Stability Control (ESC) OFF indicator light



This indicator light illuminates:

- When the Engine Start/Stop button is in the ON position. It illuminates for about 3 seconds and then goes off.
- When you deactivate ESC system by pressing the ESC OFF button.

For more information, refer to the “Electronic Stability Control (ESC)” section in chapter 6.

Immobilizer indicator light



This indicator light illuminates for up to 30 seconds:

When the vehicle detects the smart key in the vehicle with the Engine Start/Stop button in the ACC or ON position.

- Once the smart key is detected, you can start the engine.
- The indicator light goes off after starting the engine.

This indicator light blinks for a few seconds:

When the smart key is not in the vehicle.

- If the smart key is not detected, you cannot start the engine.

This indicator light illuminates for 2 seconds and goes off:

If the smart key is in the vehicle and the Engine Start/Stop button is ON, but the vehicle cannot detect the smart key.

If this occurs, we recommend that you have the vehicle inspected by an authorized retailer of Genesis Branded products.

This indicator light blinks:

Whenever there is a malfunction with the immobilizer system.

If this occurs, we recommend that you have the vehicle inspected by an authorized retailer of Genesis Branded products.

Glow indicator light (for diesel engine)

 if equipped



This indicator light illuminates:

When the engine is being preheated with the Engine Start/Stop button in the START position.

- The engine can be started after the glow indicator light goes off.
- The illumination time varies depending on the engine coolant temperature, air temperature, and battery condition.

If the indicator light remains on or blinks after the engine has warmed up or while driving, there may be a malfunction with the engine preheating system.

If this occurs, we recommend that you have the vehicle inspected by an authorized retailer of Genesis Branded products.

AUTO STOP indicator light

 if equipped



This indicator light illuminates:

When the engine enters the Idle Stop mode of ISG (Idle Stop and Go) system.

- White: When the system operating conditions are satisfied.
- Green: When the ISG system is activated.
- Yellow: Whenever there is a malfunction with the ISG function.

If this occurs, we recommend that you have the vehicle inspected by an authorized retailer of Genesis Branded products.

For more information, refer to the "Idle Stop and Go (ISG)" section in chapter 6.

***i* Information**

When the engine automatically starts by the ISG system, some warning lights (ABS, ESC, ESC OFF, MDPS or Parking brake warning light) may turn on for a few seconds. This happens because of low battery voltage. It does not mean the system has malfunctioned.

Turn signal indicator light**This indicator light blinks:**

When you operate the turn signal indicator stalk.

If any of the following occur, there may be a malfunction with the turn signal system.

- The turn signal indicator light illuminates but does not blink
- The turn signal indicator light blinks rapidly
- The turn signal indicator light does not illuminate at all

If any of these conditions occur, we recommend that you have the vehicle inspected by an authorized retailer of Genesis Branded products.

High beam indicator light**This indicator light illuminates:**

- When the headlights are on and in the high beam position
- When the turn signal lever is pulled into the Flash-to-Pass position.

Low beam indicator light**This indicator light illuminates:**

When the headlights are on.

Light ON indicator light**This indicator light illuminates:**

When the position lamps or headlamps are on.

Rear fog indicator light

 if equipped

**This indicator light illuminates:**

When the rear fog lights are on.

High Beam Assist indicator light

 if equipped



This indicator light illuminates:

When the high-beam is on with the light switch in the AUTO position.

- White: When High Beam Assist is ready to operate.
- Green: When High Beam Assist is operating.

If your vehicle detects oncoming or preceding vehicles, High Beam Assist will switch the high beam to low beam automatically.

For more information, refer to the “High Beam Assist (HBA)” section in chapter 5.

Intelligent Front-Lighting System indicator light

 if equipped



This indicator light illuminates:

When the high-beam is on with the light switch in the AUTO position.

- White: When Intelligent Front-Lighting system is ready to operate.
- Green: When Intelligent Front-Lighting system is operating.

If your vehicle detect oncoming or preceding vehicles, the Intelligent Front-Lighting system partially turns off the high beam LED lights.

For more information, refer to the “Intelligent Front-Lighting System (IFS)” section in chapter 5.

AUTO HOLD indicator light



This indicator light illuminates:

- White: When you activate Auto Hold by pressing the AUTO HOLD switch.
- Green: When you stop the vehicle completely by depressing the brake pedal with Auto Hold activated.
- Yellow: Whenever there is a malfunction with the Auto Hold function.

If this occurs, we recommend that you have the vehicle inspected by an authorized retailer of Genesis Branded products.

For more information, refer to the “Electronic Parking Brake (EPB)” section in chapter 6.

Driver attention warning light

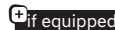
 if equipped



This indicator light illuminates:

- When the Engine Start/Stop button is in the ON position. It illuminates for about 3 seconds and then goes off.
- Yellow: When Driver Attention Warning is disabled or a malfunction is detected.

If the yellow indicator light remains on after the front view camera has been uncovered or unblocked, we recommend that your vehicle be inspected by an authorized retailer of Genesis Branded products.

This indicator light blinks:

- Yellow: When the Driver attention Warning is operating.

For more information, refer to the “Driver Attention Warning (DAW)” section in chapter 7.

Intelligent Speed Limit Assist indicator light

 if equipped

**This indicator light illuminates:**

- When the Engine Start/Stop button is in the ON position. It illuminates for about 3 seconds and then goes off.
- Yellow: When Intelligent Speed Limit Assist is off, disabled, or a malfunction is detected.

If the yellow indicator light remains on after the front view camera has been uncovered or unblocked, we recommend that your vehicle be inspected by an authorized retailer of Genesis Branded products.

For more information, refer to the “Intelligent Speed Limit Assist (ISLA)” section in chapter 7.

Cruise indicator light

 if equipped

**This indicator light illuminates:**

When the cruise control system is enabled.

For more information, refer to the “Cruise Control (CC)”, “Smart Cruise Control (SCC)” in chapter 7.

Speed Limiter indicator light**This indicator light illuminates:**

When the speed limiter is enabled.

For more information, refer to the “Manual Speed Limit Assist (MSLA)” in chapter 7.

ECO Mode Indicator Light

ECO

This indicator light illuminates

When you select "ECO" mode as drive mode.

For more information, refer to the "Drive mode integrated control system" in chapter 6.

SPORT Mode Indicator Light

SPORT

This indicator light illuminates

When you select "SPORT" mode as drive mode.

For more information, refer to the "Drive mode integrated control system" in chapter 6.

SPORT + mode indicator light

 if equipped

SPORT+

This indicator light illuminates

When you select "SPORT+" mode as drive mode.

For more information, refer to the "Drive mode integrated control system" in chapter 6.

CUSTOM mode indicator light

 if equipped

CUSTOM

This indicator light illuminates

When you select "CUSTOM" mode as drive mode.

For more information, refer to the "Drive mode integrated control system" in chapter 6.

Cluster display messages

Shift to P

This message appears if you try to turn off the vehicle without the gear in the P (Park) position.

If this occurs, the Engine Start/Stop button turns to the ACC position.

Vehicle is in N. Press START button and shift to P (and turn vehicle off)

This message appears if you try to turn off the vehicle with the gear in N (Neutral).

To turn off the vehicle:

1. Press the Engine Start/Stop button. The button will change to the ON position.
2. Press the P button to shift to P (Park).
3. Press the Engine Start/Stop button again, then the vehicle will turn off.

Low key battery

This message appears if the battery of the smart key is discharged while changing the Engine Start/Stop button to the OFF position.

Press START button while turning wheel

 if equipped

This message appears if the steering wheel does not unlock normally when the Engine Start/Stop button is pressed.

You should press the Engine Start/Stop button while turning the steering wheel right and left.

Check steering wheel lock system

 if equipped

This message appears if the steering wheel does not lock normally while the Engine Start/Stop button is pressed to the OFF position.

Press brake pedal to start engine

This message appears if the Engine Start/Stop button changes to the ACC position twice by pressing the button repeatedly without depressing the brake pedal.

You can start the vehicle by depressing the brake pedal and then pressing the Engine Start/Stop button.

Key not in vehicle

This message appears if the smart key is not in the vehicle when you leave the vehicle with the Engine Start/Stop button in the ON or Start position.

Always turn off the engine before leaving your vehicle.

Key not detected

This message appears if the smart key is not detected when you press the Engine Start/Stop button.

Press START button again

This message appears if you were unable to start the vehicle when the Engine Start/Stop button was pressed.

If this occurs, attempt to start the engine by pressing the Engine Start/Stop button again.

If the warning message appears each time you press the Engine Start/Stop button, we recommend that you have the vehicle inspected by an authorized retailer of Genesis Branded products.

Press START button with key

This warning message appears if you press the Engine Start/Stop button while the warning message "Key not detected" appears.

At this time, the immobilizer indicator light blinks.

Check BRAKE SWITCH fuse

This message appears if the brake switch fuse is disconnected.

You need to replace the fuse with a new one before starting the engine.

If that is not possible, you can start the engine by pressing the Engine Start/Stop button for 10 seconds in the ACC position.

Shift to P or N to start engine

This message appears if you try to start the engine in any other position except P (Park) or N (Neutral).

***i* Information**

You can start the engine with the gear in N (Neutral). But, for your safety, we recommend that you start the engine with the gear shifted to P (Park).

Battery discharging due to external/additional electrical devices

This message appears if the 12V battery voltage is weak due to any non-factory electrical accessories (ex. dashboard camera) while parking. Be careful that the battery is not discharged.

If the message appears after removing the non-factory electrical accessories, we recommend that you have the vehicle inspected by an authorized retailer of Genesis Branded products.

Door, Hood, trunk (or tailgate) open indicator

Sedan

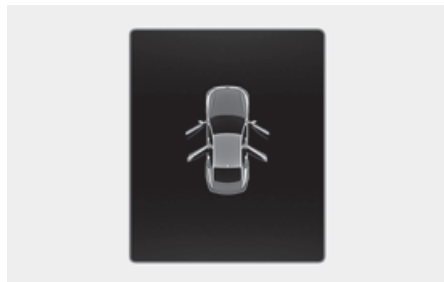

Shooting Brake

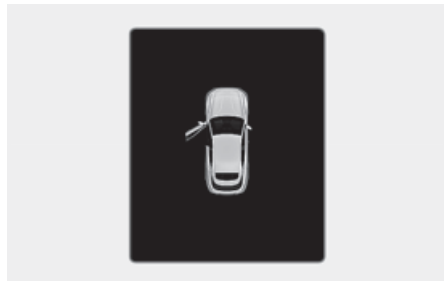

This warning appears if any door or hood or trunk (or tailgate) is left open. The warning will indicate which door is open in the display.

⚠ CAUTION

Before driving the vehicle, you should confirm that the door/hood/trunk (or tailgate) are fully closed.

Sunroof open indicator

+ if equipped

Sedan

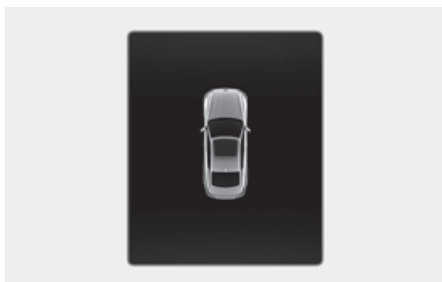

Shooting Brake

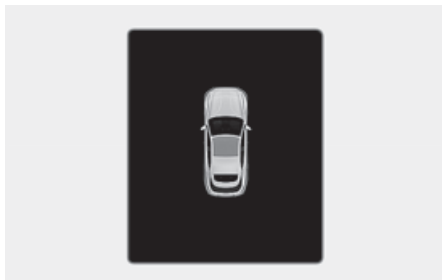

This warning appears if you turn off the engine when the sunroof is open. Close the sunroof securely before leaving your vehicle.

Low tire pressure

This warning message appears if the tire pressure is low. The corresponding tire on the vehicle will be illuminated.

For more information, refer to the “Tire Pressure Monitoring System (TPMS)” section in chapter 8.

Lights

Type A



Type B

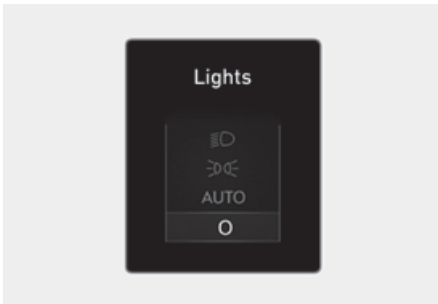

This indicator displays which exterior light is selected using the lighting control.

You can activate or deactivate Wiper/Lights display function from the Settings menu in the infotainment system. Select:

- **Setup (Settings) > Vehicle > Cluster > Content Selection > Wiper/Lights Display**

i Information

The infotainment system may change after software updates. For more information, refer to the manual provided in the infotainment system and the quick reference guide.

Wiper

Type A

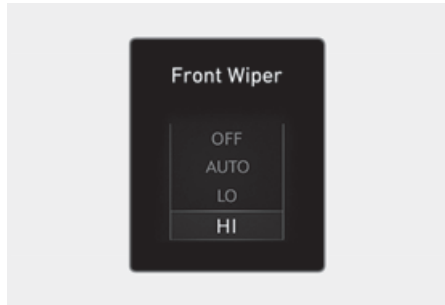

Type B



This indicator displays which wiper speed is selected using the wiper control.

You can activate or deactivate Wiper/Lights display function from the Settings menu in the infotainment system. Select:

- **Setup (Settings) > Vehicle > Cluster > Content selection > Wiper/Lights display**

i Information

The infotainment system may change after software updates. For more information, refer to the manual provided in the infotainment system and the quick reference guide.

Low washer fluid

This message appears if the washer fluid level in the reservoir is nearly empty.

Have the washer fluid reservoir refilled.

Low fuel

This message appears if the fuel tank is almost out of fuel.

When this message appears, the low fuel level warning light in the cluster will come on.

It is recommended to look for the nearest fueling station and refuel as soon as possible.

Low engine oil

 if equipped

This warning message appears when the engine oil level should be checked.

If this warning message appears, check the engine oil level as soon as possible and add engine oil as required.

Slowly pour the recommended oil little by little into a funnel.

Use only the specified engine oil. (Refer to the “Recommended lubricants and capacities” section in chapter 2.)

Do not overfill the engine oil. Make sure the oil level is not above F (Full) mark on the dipstick.

***i* Information**

After adding engine oil, if you travel about 50-100 km (31-62 miles) after the engine warms up, the warning message will disappear.

Engine overheated/Engine has overheated

This message appears when the engine coolant temperature is above 120°C (248°F). This means that the engine is overheated and may be damaged.

If your vehicle is overheated, refer to the “If the engine overheats” section in chapter 8.

Check exhaust system

 if equipped

This message appears if there is a problem with the GPF or DPF system. At this time, the GPF warning light will also blink. If this occurs, we recommend that you have the GPF or DPF system checked by an authorized retailer of Genesis Branded products.

GPF : Gasoline Particulate Filter

DPF : Diesel Particulate Filter

Check haptic steering wheel system

 if equipped

This message appears if there is a problem with the haptic steering wheel system. We recommend that you have the vehicle inspected by an authorized retailer of Genesis Branded products.

Check headlight

 if equipped

This message appears if the headlights are not operating properly. A lamp may need to be replaced.

Make sure to replace the burned out bulb with a new one of the same wattage rating.

Check turn signal

 if equipped

This message appears if the turn signal lamps are not operating properly. A lamp may need to be replaced.

Make sure to replace the burned out bulb with a new one of the same wattage rating.

Check headlight LED

 if equipped

This message appears if there is a problem with the LED headlight. We recommend that you have the vehicle inspected by an authorized retailer of Genesis Branded products.

Cluster display (Type A)

Cluster display control

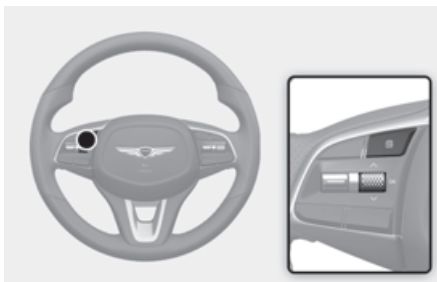

The cluster display modes can be changed by using the control switches.

Switch	Operation	Function
	Press	MODE button for changing View modes
	Scroll	UP, DOWN switch for changing items in Utility view and Option menu
OK	Press	SELECT/RESET switch for entering Option menu
	Press and hold	SELECT/RESET switch for retrieving assist information or resetting the selected item

View modes

View modes	Explanation
Driving Assist	Driving Assist view displays the status of the vehicle's Driving Assist systems.
Turn by Turn	Turn By Turn view displays the state of the navigation.
Utility	Utility view displays driving information such as the trip distance, fuel economy and etc.

The information provided may differ depending on which functions are applicable to your vehicle.

Driving Assist view

Sedan



Shooting Brake



The status of Smart Cruise Control, Lane Following Assist, Highway Driving Assist, etc. appears when Driving Assist view is selected.

For more information, refer to each system information section in chapter 7.

Turn By Turn (TBT) view

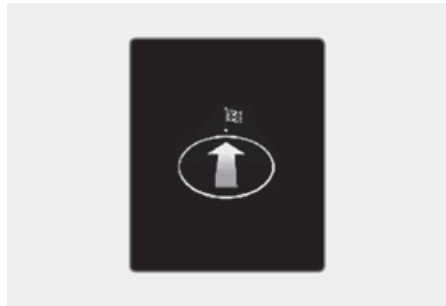

Turn-by-turn navigation, distance/time to destination information appears when Turn by Turn view is selected.

Utility view

In the Utility view, using the \wedge , \vee (UP, DOWN) switch, you may change through items in the following order.

Gauges (Sedan, if equipped)



This mode displays information related to your engine such as engine oil temperature (1), current torque (2) and turbo boost pressure (3).

Drive info

Type A



Type B



Trip distance, total driving time, average fuel economy, instant fuel economy appear.

The information is combined for each ignition cycle. However, when the engine has been OFF for 4 hours or longer the Drive Info screen will reset.

To reset manually, press the **OK** switch on the steering wheel for more than 1 second when "**Drive Info**" (or "**Drive information**") appears.

Since refuel(l)ing

Type A

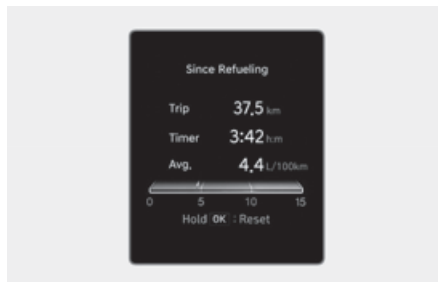

Type B

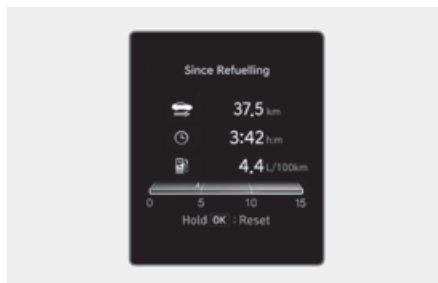

Trip distance, total driving time, average fuel economy, instant fuel economy after the vehicle has been refueled appear.

To reset manually, press the **OK** switch on the steering wheel for more than 1 second when "**Since Refueling**" (or "**Since Refuelling**") appears.

Accumulated info

Type A

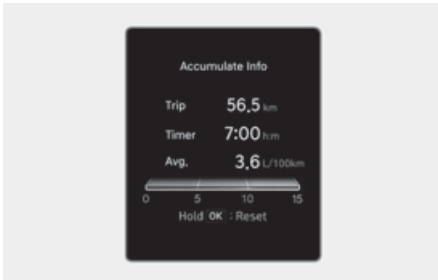

Type B

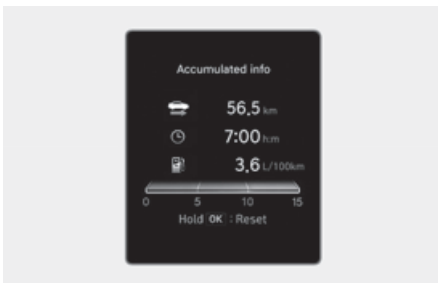

Accumulated Trip distance, total driving time, average fuel economy, instant fuel economy appear.

The information is accumulated starting from the last reset.

To reset manually, press the **OK** switch on the steering wheel for more than 1 second when "**Accumulate Info**" (or "**Accumulated info**") appears.

Digital speedometer

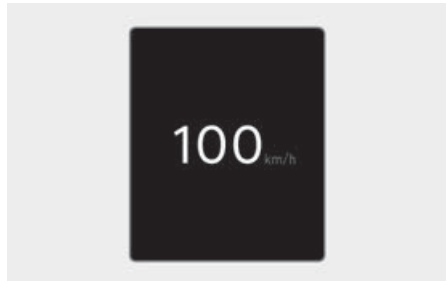

Digital speedometer display shows the speed of the vehicle.

Auto stop

 If equipped

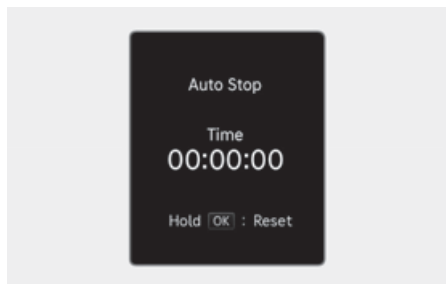

AUTO STOP display shows the elapsed time of engine stop by Idle Stop and Go system.

For more information, refer to the "Idle Stop and Go (ISG)" section in chapter 6.

Attention level

+ if equipped

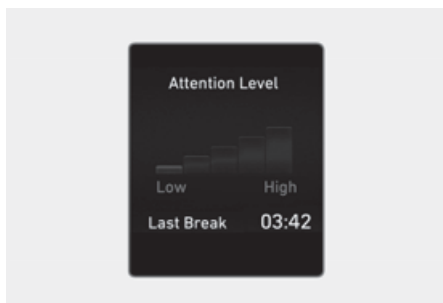

The driver's attention level is shown based on the driver's driving pattern. For more information, refer to the "Driver Attention Warning (DAW)" section in chapter 7.

Speed limit warning

+ if equipped

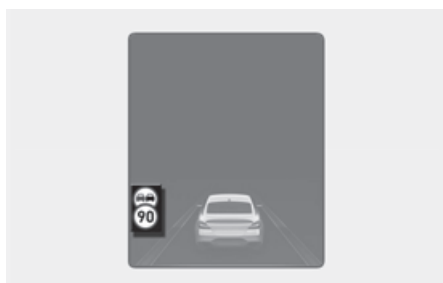

The driver can monitor the information provided from Intelligent Speed Limit Assist.

For more information, refer to the "Intelligent Speed Limit Assist (ISLA)" section in chapter 7.

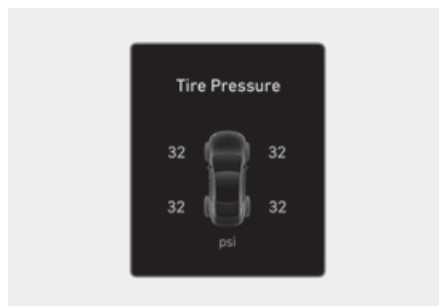
Tire pressure/Tyre pressure

The tire pressure of each tire appears. For more information, refer to the "Tire Pressure Monitoring System (TPMS)" section in chapter 8.

Engine temperature

Type A

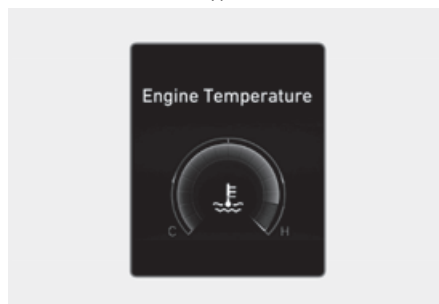

Type B

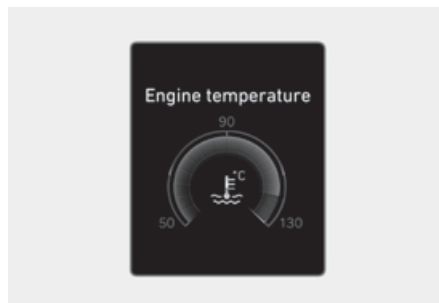

Engine coolant temperature gauge display shows the temperature of the engine coolant when the engine is running.

DEF level/Urea level (for diesel engine)

 if equipped

Type A

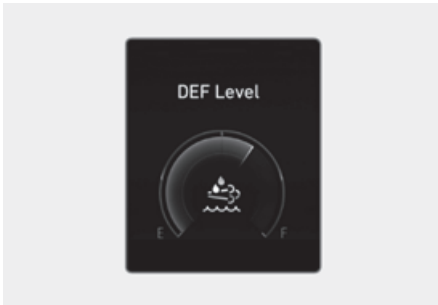

Type B

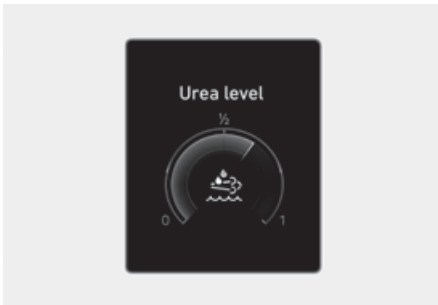

DEF (Diesel Exhaust Fluid) level gauge display shows the amount of the remaining urea solution in the urea solution tank.

For more information, refer to the "Adding urea solution" section in the chapter 9.

Select contents/Contents configuration

You can select the items to be displayed in Utility view.

1. Press and hold the **OK** switch on the steering wheel.

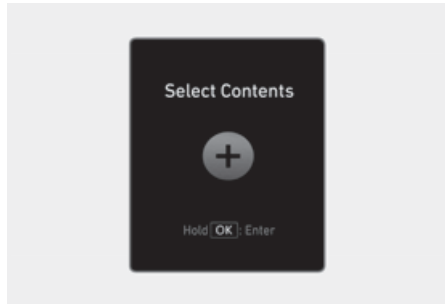

2. Use the \wedge , \vee (UP, DOWN) switch to change items, and press the OK switch to select or deselect the item.
3. After selecting the items to be displayed in the Utility view, press the  (MODE) button to exit the "Select Contents" display.

WARNING

To avoid driver distractions, do not adjust the setting while driving the vehicle which may lead to an accident.

Option menu

Press the OK switch to enter Option menu.

WARNING

To avoid driver distractions, do not adjust the setting while driving which may lead to an accident.

i Information

The information provided may differ depending on which functions are applicable to your vehicle.

Menu	Explanation
Service messages	To check vehicle warning messages.
Head-up display	To activate or deactivate head-up display.
Driver assistance settings	To directly display Driver Assistance menu on the infotainment system
Speed unit	To set speed unit between km/h and MPH.

Service messages

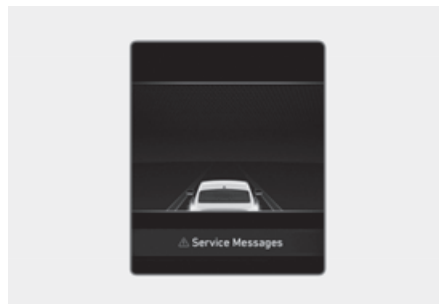

When Service Messages menu is selected, press the **OK** switch on the steering wheel to check vehicle warning messages.

Head-up display

 if equipped

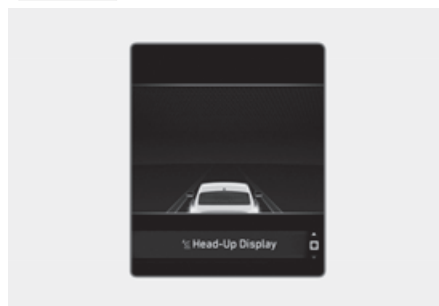

When Head-Up Display menu is selected, press the OK switch on the steering wheel. You may select or deselect head-up display by pressing the **OK** switch.

Driver Assistance settings



When Driver Assistance Settings menu is selected, press the OK switch on the steering wheel. The "**Driver Assistance**" menu will be displayed on the infotainment system.

Speed unit

 if equipped

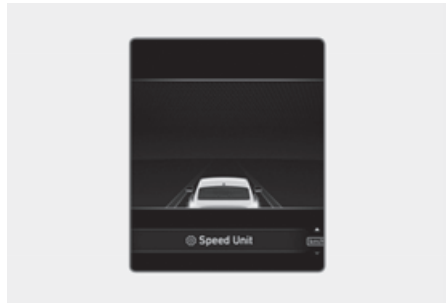

When the Speed Unit menu is selected, press the **OK** switch on the steering wheel. You can change the speed unit setting between km/h and MPH for the cluster.



Cluster display (Type B)

 if equipped

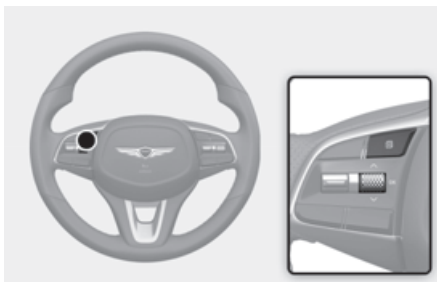



Cluster display control



The cluster display modes can be changed by using the control switches.

Switch	Function
	MODE button for changing modes
	MOVE switch for changing items
OK	SELECT/RESET button for setting or resetting the selected item

View modes

View modes	Symbol	Explanation
Sport (Sedan, if equipped)		<ul style="list-style-type: none"> This mode displays information related to engine.
Trip Computer		<ul style="list-style-type: none"> This mode displays driving information such as the tripmeter, fuel economy, etc. This mode displays digital speedometer. This mode displays the elapsed time of engine stop by Idle Stop and Go. This mode displays the approximate amount of remaining urea solution inside the urea solution tank. For more information, refer to the "Trip computer" section in this chapter.
Turn By Turn (TBT)		<ul style="list-style-type: none"> This mode displays the state of the navigation.
Driving Assist		<ul style="list-style-type: none"> This mode displays the state of : <ul style="list-style-type: none"> - Smart Cruise Control - Lane Keeping Assist - Driver Attention Warning - Tire pressure Monitoring system For more information, refer to each function information section in each chapter.
Warning		<ul style="list-style-type: none"> This mode displays warning messages related to the vehicle when one or more systems is not operating normally.

The information provided may differ depending on which functions are applicable to your vehicle.

Sport mode (Sedan, if equipped)



This mode displays information related to your engine such as engine oil temperature(1), current torque(2) and turbo boost pressure(3).

Trip computer mode

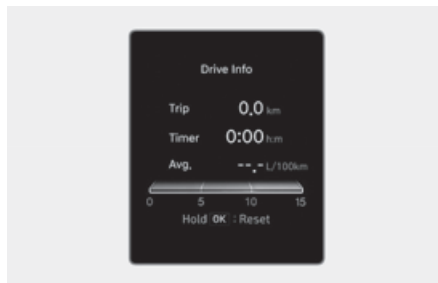

The trip computer mode displays information related to vehicle driving parameters including Trip distance, total driving time, average fuel economy, instant fuel economy.

For more information, refer to the "Trip computer" section in this chapter.

Turn By Turn (TBT) mode

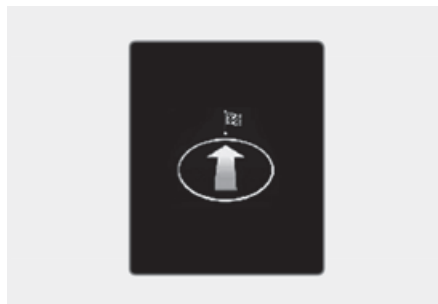

Turn-by-turn navigation, distance/time to destination information appears when Turn by Turn view is selected.

Driving Assist mode

Sedan



Shooting Brake



The status of Manual Speed Limit Assist, Smart Cruise Control, Lane Following Assist, Highway Driving Assist, etc. appears when Driving Assist view is selected.

For more information, refer to each system information section in chapter 7.

Driver attention warning

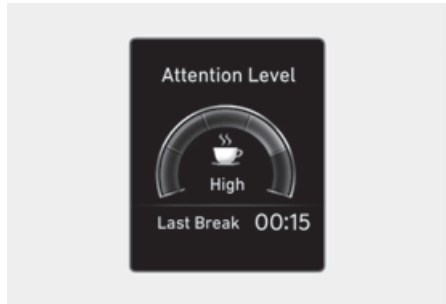

This mode displays the state of Driver Attention Warning (DAW).

For more information, refer to the "Driver Attention Warning (DAW)" section in chapter 7.

Tire pressure/Tyre pressure



This mode displays information related to Tire Pressure.

For more information, refer to the "Tire Pressure Monitoring System (TPMS)" in chapter 8.

Warning mode

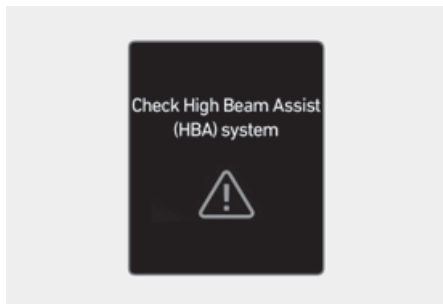

This warning light informs the driver the following situations.

- Forward Collision-Avoidance Assist malfunction (if equipped)
- Forward Collision-Avoidance Assist radar blocked (if equipped)
- Blind-Spot Collision Warning malfunction (if equipped)
- Blind-Spot Collision Warning radar blocked (if equipped)
- LED headlamp malfunction (if equipped)
- High Beam Assist malfunction (if equipped)
- Smart Cruise Control malfunction (if equipped)
- Smart Cruise Control radar blocked (if equipped)
- Tire Pressure Monitoring System (TPMS) malfunction

The Master Warning Light illuminates if one or more of the above warning situations occur.

At this time, a Master Warning icon (⚠) will appear beside the User Settings icon (⚙), on the cluster display.

If the warning situation is solved, the master warning light will be turned off and the Master Warning icon will disappear.

Trip computer

The trip computer is a microcomputer-controlled driver information system that displays information related to driving.

i Information

Some driving information stored in the trip computer (for example Average Vehicle Speed) resets if the battery is disconnected.

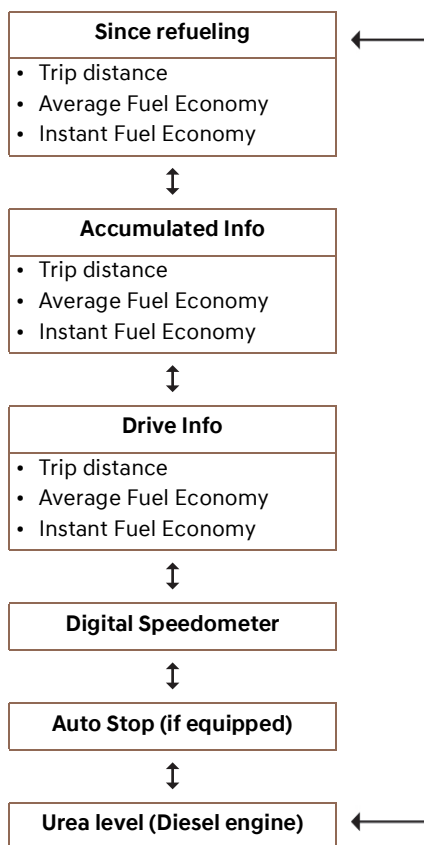

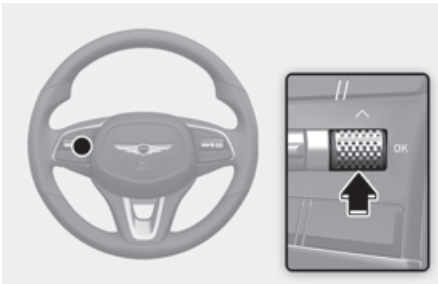

To change the trip mode, toggle the "∧, ∨" switch on the steering wheel.

Since refuel(l)ing

Type A

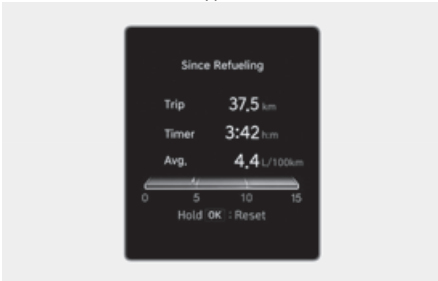

Type B



Trip distance, total driving time, average fuel economy, instant fuel economy after the vehicle has been refueled appear.

To reset manually, press the **OK** switch on the steering wheel for more than 1 second when "**Since Refueling**" (or "**Since Refuelling**") appears.

Accumulated info

Type A

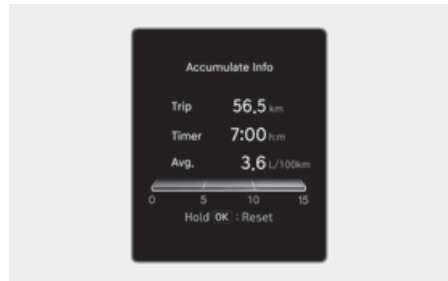

Type B

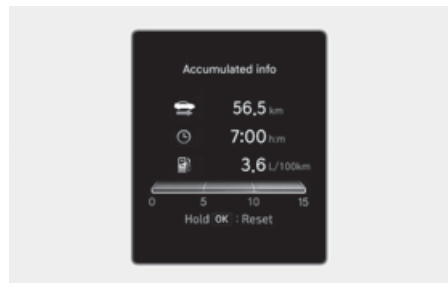

Accumulated trip distance, total driving time, average fuel economy, instant fuel economy appear.

The information is accumulated starting from the last reset.

To reset manually, press the **OK** switch on the steering wheel for more than 1 second when "**Accumulate Info**" (or "**Accumulated info**") appears.

Drive info

Type A



Type B



Trip distance, total driving time, average fuel economy, instant fuel economy appear.

The information is combined for each ignition cycle. However, when the engine has been OFF for 3 minutes or longer the Drive Info screen will reset.

To reset manually, press the **OK** switch on the steering wheel for more than 1 second when "**Drive Info**" (or "**Drive information**") appears.

Digital speedometer

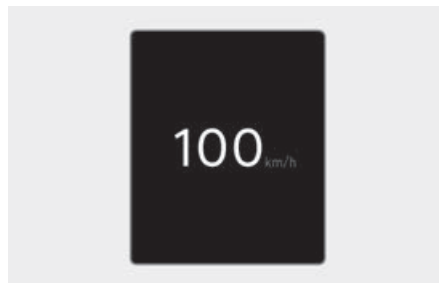

Digital speedometer display shows the speed of the vehicle.

AUTO STOP

+ if equipped

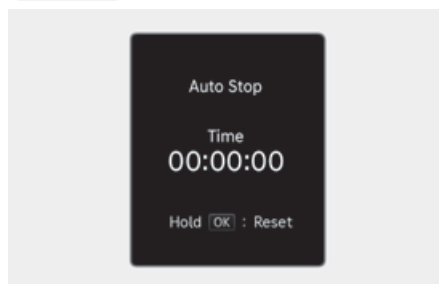

AUTO STOP display shows the elapsed time of engine stop by Idle Stop and Go system.

For more information, refer to the "Idle Stop and Go (ISG)" section in chapter 6.

Urea level (Diesel engine)

 if equipped

Type A



Type B



This mode displays the approximate amount of remaining urea solution inside the urea solution tank.

Add the urea before the level indicates [E] or [0].

For more information, refer to the “Selective Catalytic Reduction (SCR) (for diesel engine)” in chapter 9.

3D instrument cluster (for 12.3-inch 3D cluster)

3D cluster setting

To use the 3D cluster, press the Engine Start/Stop button to the ON position, and then select **Setup (Settings) > Vehicle > Cluster > 3D cluster >**

Maximum/Normal/Off in infotainment system.

To use the cluster 2D, select “Off”.

Information

The infotainment system may change after software updates. For more information, refer to the manual provided in the infotainment system and the quick reference guide.

Recommendations to optimize the 3D effect

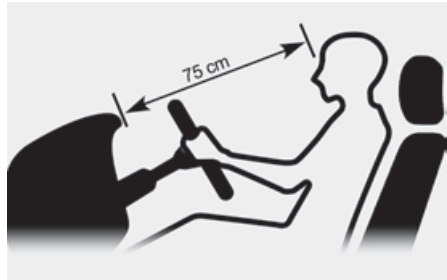

- Adjust the height of the seat and steering wheel so that the instrument cluster and camera module can be seen at a glance.
- The optimal distance to maximize the 3D effect is 75 cm (30 in.). Adjust the distance between the driver's seat and the instrument cluster.
- Hold the steering wheel with both hands and drive in an upright position.

i Information

- When your face gets too close or far to the instrument cluster, or the camera on the instrument cluster is blocked by the steering wheel or other objects, the 3D cluster changes to 2D automatically. However if the object blocking the camera is removed, the cluster changes back to 3D automatically.
- If outside temperature is below 4°C (39°F), it may change to 2D about 1 to 10 minutes.
- Two red lights may appear on the camera in the following conditions when:
 - The outside brightness is dim or driving at night
 - The vehicle drives inside a building, such as a basement parking lot
 - The camera case of the instrument cluster is partially damaged

⚠ CAUTION

- It may sometimes be difficult to read information on the 3D cluster in the following situations. You must change the cluster to 2D for safe driving.
 - The driver is wearing sunglasses, special glasses, infrared cutoff glasses, refracting glasses or thick glasses
 - The driver has heavy eye makeup (eyeliner, mascara, color makeup, false eyelash) or eye piercing
 - The driver's view is blocked by his/her hair, etc.
 - The driver is winking or wearing an eye patch on one eye
 - The driver's face is covered partially by a mask, muffler, hijab, etc.
- The driver's view is blocked by incoming light from outside of the vehicle
- Light from outside, sunlight or infrared LED light of the camera is reflected on the glasses or sunglasses
- The driver turns or lowers his/her head so that the face or an eye is hidden from the camera
- The driver shakes his/her head up and down, or adverse road conditions cause excessive vehicle vibrations while driving
- The driver is too tall or short
- More than two people are looking at the instrument cluster simultaneously from the driver's seat
- The driver's eyesight of both eyes are severely different
- The driver has a severe headache
- Do not look toward the camera within 20 cm (8 in.) for longer than a minute.
- If you use the 3D cluster while your vehicle is stopped, it can cause eye strains or dizziness.
- We recommend people who are pregnant, elderly or has motion sickness, avoid using the cluster in 3D.

⚠ WARNING

- You should not use the 3D cluster if you or any of your family members or relatives has a history of epilepsy, convulsions, etc. Flashing or flickering lights or specific or regular patterns shown on the cluster may stimulate epilepsy, convulsions, etc.
- You should not use the 3D effect immediately if you feel any of the following symptoms:
Haziness, unconsciousness, disorientation, nausea, headache, fatigue, dizziness, etc.

⚠ WARNING

While replacing the instrument cluster by yourself, be cautious of the heat from the top and backside of the instrument cluster.

NOTICE



[A] Interior view camera

- Do not apply any impact on the surface of the instrument cluster, interior view camera or around the area of the interior view camera. If interior view camera is damaged, the system may not operate properly.
- Do not place a mobile phone or an object in front of the interior view camera. The surface of the instrument cluster or interior view camera might be damaged due to an impact while driving.
- Do not place anything on interior view camera or in front of interior view camera while driving. Interior view camera may not operate properly.
- When cleaning the instrument cluster or interior view camera, wipe with a soft and clean cloth to prevent damages on the surface of the cluster or interior view camera lens. In addition, you should not use sharp tools near the cluster or interior view camera, or use chemicals to clean the cluster or interior view camera.
- Always keep interior view camera clean and dry.

Vehicle (infotainment system)



Vehicle in the infotainment system provides user options for a variety of settings including door lock/unlock features, convenience features, driver assistance settings, etc.

Vehicle menu

- Driver Assistance
- Drive Mode
- Head-Up Display
- Cluster
- Climate
- Seat
- Light
- Door
- Convenience
- Reset

The information provided may differ depending on which functions are applicable to your vehicle.

WARNING

Do not operate the Vehicle while driving. This may cause distraction resulting in an accident.

Setting your vehicle

1. Press the **SETUP** button on the main keyboard.



2. Select "**Vehicle**" and change the setting of the features.

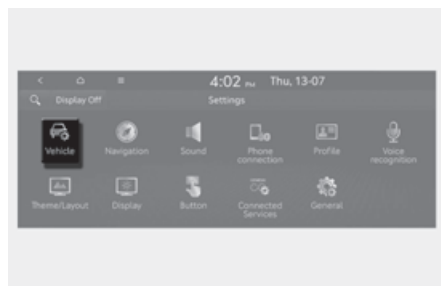

i **Information**

The infotainment system may change after software updates. For more information, refer to the manual provided in the infotainment system and the quick reference guide.

5. Convenience features

Accessing your vehicle.....	5-5
Smart key.....	5-5
Immobilizer system.....	5-12
Door locks	5-13
Operating door locks from outside the vehicle	5-13
Operating door locks from inside the vehicle.....	5-14
Impact sensing door unlock system.....	5-16
Speed sensing door lock system	5-16
Automatic door lock and unlock features.....	5-17
Child-protector rear door locks	5-17
Theft-alarm system	5-18
Rear Occupant Alert (ROA)	5-19
Integrated memory system	5-20
Storing memory positions.....	5-20
Recalling memory positions.....	5-21
Resetting the system	5-21
Seat easy access	5-22
Steering wheel	5-23
Motor Driven Power Steering (MDPS).....	5-23
Tilt/Telescopic steering	5-24
Horn	5-25
Heated steering wheel	5-26
Mirrors	5-27
Inside rearview mirror.....	5-27
Outside rearview mirrors.....	5-36
Reverse parking aid	5-38
Windows.....	5-40
Power windows.....	5-41
Remote window opening/closing function	5-44
Wide sunroof.....	5-45
Power sunshade.....	5-45
Tilt open/close.....	5-46
Slide open/close	5-46
Automatic reversal.....	5-47
Resetting the sunroof	5-48
Sunroof open warning	5-49

Hood	5-49
Opening the hood.....	5-49
Closing the hood	5-50
Non-Powered Trunk	5-50
Opening the trunk	5-50
Closing the trunk	5-51
Emergency trunk safety release.....	5-51
Power trunk	5-52
Power trunk operating conditions	5-52
Operating the power trunk	5-54
Setting the power trunk	5-56
Resetting the power trunk.....	5-56
Emergency trunk safety release.....	5-56
Power tailgate	5-57
Power tailgate operating conditions.....	5-57
Operating the power tailgate	5-59
Power tailgate settings	5-61
Resetting the power tailgate	5-62
Emergency tailgate safety release	5-63
Smart trunk (or tailgate)	5-63
How to use the smart trunk (or tailgate)	5-64
Deactivating smart trunk (or tailgate).....	5-65
Detecting area	5-66
Fuel filler door	5-67
Opening the fuel filler door.....	5-67
Closing the fuel filler door	5-68
Emergency fuel filler lid release	5-69
Head-UP display (HUD).....	5-70
Head-UP display settings	5-70
Head-UP display information	5-70
Precautions while using the Head-UP display	5-71
Exterior lights	5-72
Lighting control	5-72
High beam operation	5-73
Turn signals and lane change signals	5-74
Rear fog light	5-74

5. Convenience features

Battery saver function	5-74
Headlight delay function	5-75
Daytime Running Light (DRL)	5-75
Headlight leveling device	5-75
Reverse guide light	5-75
Headlight moisture removal function	5-76
Welcome system.....	5-76
Puddle light	5-77
Intelligent Front-Lighting System (IFS).....	5-77
System setting.....	5-77
System operation.....	5-78
System malfunction and limitations.....	5-79
High Beam Assist (HBA)	5-81
High Beam Assist setting.....	5-81
High Beam Assist operation.....	5-82
High Beam Assist malfunction and limitations.....	5-82
Interior lights.....	5-84
Interior lamp AUTO cut.....	5-84
Front lamps.....	5-84
Rear lamps.....	5-85
Vanity mirror lamp	5-85
Glove box lamp	5-85
Mood lamp/foot lamp	5-86
Trunk lamp (Sedan).....	5-87
Tailgate lamp (Shooting Brake).....	5-87
Wipers and washers	5-88
Front windshield wipers	5-89
Front windshield washers	5-90
Rear windshield wipers and washers	5-92
Automatic climate control system	5-93
Automatic temperature control mode	5-95
Manual temperature control mode	5-96
Clean air system	5-104
System operation.....	5-107
System maintenance	5-109
Windshield defrosting and defogging	5-111

To defog inside windshield	5-111
To defrost outside windshield	5-112
Defogging logic	5-112
Rear window defroster.....	5-113
Climate control additional features.....	5-114
Air conditioning auto-drying	5-114
Auto defogging system.....	5-114
Auto dehumidify.....	5-116
Recirculating air when washer fluid is used	5-116
Sunroof inside air recirculation	5-117
Warmer/ventilation based on climate settings (for driver's seat)	5-117
Climate touchscreen haptic intensity.....	5-117
Storage compartment	5-118
Center console storage.....	5-118
Glove box	5-119
Sunglass holder	5-119
Interior features	5-120
Cup holder	5-120
Ashtray	5-121
Sunvisor.....	5-121
Power outlet	5-122
USB charger.....	5-123
Wireless smartphone charging system	5-124
Clock.....	5-126
Coat hook.....	5-126
Floor mat anchor(s).....	5-126
Luggage net holder	5-127
Shopping holder	5-128
Infotainment system.....	5-128
USB Port	5-128
Antenna	5-129
Steering wheel remote controls.....	5-130
Infotainment system	5-130
Voice recognition	5-131
Bluetooth® Wireless Technology.....	5-131
Lexicon premium sound system	5-131

Accessing your vehicle

Smart key

Type A



Type B



Your Genesis Branded Vehicle uses a smart key, which you can use to lock or unlock the driver and passenger doors or the rear trunk (or tailgate).

- (1) Door lock
- (2) Door unlock
- (3) Trunk open (or tailgate open/close)
- (4) Remote start

Locking your vehicle

To lock your vehicle using the door handle touch sensor or the smart key:

1. Make sure all doors, the hood and the trunk (or tailgate) are closed.
2. Make sure you have the smart key in your possession.
3. Touch the touch sensor on the door handle (the engraved part) or press the Door Lock button (1) on the smart key. The hazard warning lights will blink.



4. Make sure the doors are locked by pulling the door handle.

When the vehicle is locked by using the touch sensor, the unlock sensor of door outside handle is not operated for about 3 seconds.

i Information

- The outside rearview mirror will fold if **On door unlock** is selected from the Settings menu in the infotainment system. Select:
 - **Setup (Settings) > Vehicle > Light > Welcome mirror/light > On door unlock**
 The infotainment system may change after software updates. For more information, refer to the manual provided in the infotainment system and the quick reference guide.
- The door handle touch sensor will only operate when the smart key is within 0.7-1 m (28-40 in.) from the outside door handle.
- Touching the door handle touch sensor does not unlock the doors. To unlock the doors, refer to the "Smart key".

Note that you cannot lock your vehicle using the door handle touch sensor if any of the following occur:

- The smart key is in the vehicle.
- The Engine Start/Stop button is from ACC or ON position.
- Any of the doors are open except for the trunk (or tailgate).

WARNING

Do not leave the smart key in your vehicle with unsupervised children. Unattended children could press the Engine Start/Stop button and may operate power windows, lock the doors or other controls, or even make the vehicle move, which could result in serious injury or death.

Unlocking your vehicle



To unlock your vehicle using the door handle touch sensor or the smart key:

1. Make sure you have the smart key in your possession.
2. Put your hand in the door handle or press the Door Unlock button (2) on the smart key. All doors will unlock and the hazard warning lights will blink two times.
3. After unlocking the doors, the doors will automatically relock after 30 seconds unless a door is opened.

When the vehicle is unlocked by using the touch sensor, the lock sensor of door outside handle is not operated for about 2 seconds.

i Information

- The outside rearview mirror will unfold if **On door unlock** is selected from the Settings menu in the infotainment system. Select:
 - Setup (Settings) > Vehicle > Light > Welcome mirror/light > On door unlock**
- The infotainment system may change after software updates. For more information, refer to the manual provided in the infotainment system and the quick reference guide.
- The door handle touch sensor will only operate when the smart key is within 0.7-1 m (28-40 in.) from the outside door handle.
- The doors may lock or unlock if the touch sensor of the outer door handle is recognized while washing your car or due to heavy rain.
- To prevent unintentional door lock or unlock:

Press the lock button on the smart key and immediately press the unlock button along with the lock button for more than 4 seconds. The hazard warning lights will blink four times. At this time, the doors will not lock or unlock even though the touch sensor is touched on the outside door handle.

To deactivate the function, press the door lock or unlock button on the smart key.
- The doors may not lock or unlock in the following situations.
 - If the touch sensor is touched with gloves on
 - If the door is suddenly approached

Opening the trunk (or tailgate)

Sedan



Shooting brake

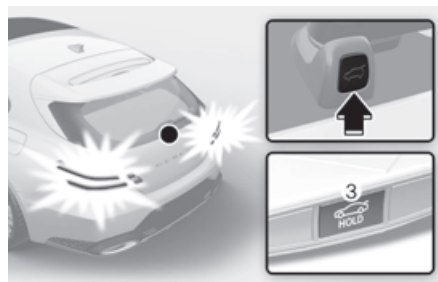

To open the trunk (or tailgate):

1. Make sure you have the smart key in your possession.
2. Press either the trunk (or tailgate) open/close button on the vehicle or press and hold the trunk open (or tailgate open/close) button (3) on the smart key for more than 1.5 seconds. The hazard warning lights will blink two times and the trunk (or tailgate) will open.

i Information

The trunk open (or tailgate open/close) button will only operate when the smart key is within 0.7 m (28 in.) from the trunk (or tailgate).

Remotely starting vehicle

 if equipped

You can start the vehicle using the Remote Start button (4) on the smart key.

To start the vehicle remotely:

1. Press the door lock button on the smart key within 10 m (32 ft.) from the vehicle.
2. Press the Remote Start button (4) for more than 2 seconds within 4 seconds after pressing the door lock button.
3. The hazard warning lights will blink and the engine will start.
4. To turn off the remote start function, press the Remote Start button (4) once.

***i* Information**

- The vehicle must be in P (Park) for the remote start function to start.
 - The engine turns off if you get on the vehicle without a registered smart key.
 - The engine turns off if you do not get on the vehicle within 10 minutes after remotely starting the vehicle.
 - The Remote Start button (4) may not operate if the smart key is not within 10 m (32 ft.).
 - The vehicle will not remotely start if the engine hood or trunk (or tailgate) is opened.
 - Do not idle the engine for a long period.
 - Do not operate remote start in closed areas where there is no adequate ventilation for the engine exhaust.
-

Starting the vehicle

You can start the vehicle without inserting the key.

For more information, refer to the “Engine Start/Stop button” section in chapter 6.

***i* Information**

If the smart key is not moved for some time, the detection function for smart key operation will pause. Lift the smart key to activate the detection again.

NOTICE

To prevent damaging the smart key:

- Keep the smart key in a cool, dry place to avoid damage or malfunction. Exposure to moisture or high temperature may cause the internal circuit of the smart key to malfunction which may not be covered under warranty.
 - Avoid dropping or throwing the smart key.
 - Protect the smart key from extreme temperatures.
-

Key cylinder (Driver door)

A key cylinder is located on the driver side door handle hidden behind a plastic cover. Using the mechanical key, push and hold the key cylinder cover release button located on the underside of the door handle.

Use the mechanical key inserted into the release button slot to open the cover outward. Once the cover is off, the mechanical key can be inserted into the key cylinder to lock or unlock the vehicle.

Loss of a smart key

A maximum of two smart keys can be registered to a single vehicle. If you happen to lose your smart key, it is recommended that you should immediately take the vehicle and remaining keys to your authorized retailer of Genesis Branded products or tow the vehicle, if necessary.

Smart key precautions

The smart key may not work if any of the following occur:

- The smart key is close to a radio transmitter such as a radio station or an airport which can interfere with normal operation of the transmitter.
- The smart key is near a mobile two way radio system or a mobile phone.
- Another vehicle's smart key is being operated close to your vehicle.
- The smart key is near any normal electronic devices or credit cards.
- If your windows are tinted, especially with metallic window tint, it may cause frequency interference, reducing the smart key operating range.

If the smart key does not work correctly, open and close the door with the mechanical key. If you have a problem with the smart key, it is recommended to contact an authorized retailer of Genesis Branded products.

If the smart key is in close proximity to your mobile phone, the signal could be blocked by your mobile phone's normal operational signals. This is specifically relevant when the phone is active such as making and receiving calls, text messaging, and/or sending/receiving emails. If possible, avoid keeping the smart key and your mobile phone in the same location such as a pants or jacket pocket to avoid interference between the two devices.

NOTICE

- Keep the smart key away from electromagnetic materials that blocks electromagnetic waves to the key surface.
- Always have the smart key with you when leaving the vehicle. If the smart key is left near the vehicle, the vehicle battery may be discharged.

Battery replacement

If the smart key is not working properly, try replacing the battery with a new one.

Battery Type: CR2450

To replace the battery:

1. Press the button (A) to remove the keyring fixed appliance.



2. Insert a flat-head screwdriver into the inner groove to remove the smart key cover.
3. Remove the old battery and insert the new battery. Make sure the battery position is correct.



4. Reinstall smart key cover in the reverse order of removal.

If you suspect your smart key might have sustained some damage, or you feel your smart key is not working correctly, it is recommended that you contact an authorized retailer of Genesis Branded products.

! WARNING

THIS PRODUCT CONTAINS A BUTTON BATTERY.

If swallowed, a lithium button battery can cause severe or fatal injuries within 2 hours. Keep batteries out of reach of children.

If you think batteries may have been swallowed or placed inside any part of the body, seek immediate medical attention.

i Information



An inappropriately disposed battery can be harmful to the environment and human health. Dispose of the battery according to your local law(s) or regulations.

Mechanical key

If the smart key does not operate normally, you can lock or unlock the driver's door by using the mechanical key.

1. Press the Genesis text section of the Mechanical key to remove the case.



2. Remove the mechanical key from the case.



3. After use, reinstall the mechanical key in the reverse order of removal.

Restrictions in handling keys

When leaving keys with parking lot and valet attendants, the following procedures will ensure your vehicle's glove box compartment can only be opened with the mechanical key.

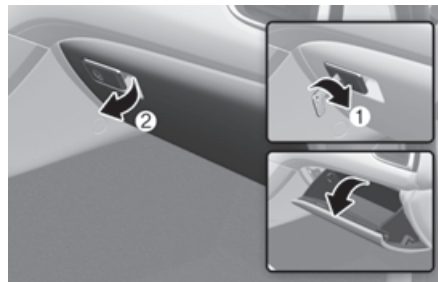

To lock:

1. Lock the glove box using the mechanical key.
2. Leave the smart key with the attendant and keep the mechanical key with you.

The smart key can only be used to start the engine and operate door locks.

To unlock:

Open the glove box with the mechanical key.

Immobilizer system

The immobilizer system protects your vehicle from theft. If an improperly coded key (or other device) is used, the engine's fuel system is disabled.

When the Engine Start/Stop button is pressed to the ON position, the immobilizer system indicator should come on briefly, then go off. If the indicator starts to blink, the system does not recognize the coding of the key.

Press the Engine Start/Stop button to the OFF position, then press the Engine Start/Stop button to the ON position again.

In some circumstances, the vehicle may not recognize your smart key if another smart key device is nearby or a metal object such as a key chain is causing interference with the smart key.

If this occurs, your vehicle may not start. Remove any metal objects or additional keys near the smart key before attempting to start the vehicle again.

If the system repeatedly does not recognize the coding of the key, it is recommended that you contact your retailer of Genesis Branded products.

Do not attempt to alter this system or add other devices to it. Electrical problems could result that may make your vehicle inoperable.

WARNING

In order to prevent theft of your vehicle, do not leave spare keys anywhere in your vehicle. Your immobilizer password is a customer unique password and should be kept confidential.

NOTICE

The transponder in your key is an important part of the immobilizer system. It is designed to give years of trouble-free service, however you should avoid exposure to moisture, static electricity and rough handling. Immobilizer system malfunction could occur.

Door locks

Operating door locks from outside the vehicle

Mechanical key



In order to operate door lock by using mechanical key, turn the key after removing the cover.

To remove the cover:

1. Pull out the door handle.
2. Press the lock located at the bottom of the cover with a key or flat-head screwdriver (1).
3. Push out the cover (2) while pressing the lock.

After removing the cover, turn the key counterclockwise to lock (A) or turn the key clockwise to unlock (B).

If you lock the driver's door with a mechanical key, the driver's door will lock. If you unlock the driver's door with a mechanical key, the driver's door will unlock.

Once the doors are unlocked, they may be opened by pulling the door handle. When closing the door, push the door by hand. Make sure that doors are closed securely.

NOTICE

Do not apply excessive force on the door and door handle. It may damage the door and door handle.

i Information

When the keyhole freezes and does not open, lightly tap or indirectly warm (i.e. hand temperature) the keyhole.

Smart key

Lock



Touch the touch sensor on the front outside door handle (the engraved part) while carrying the smart key with you or press the Door Lock button on the smart key, all doors will lock.

Unlock



Put your hand in the front outside door handle while carrying the smart key with you or press the Door Unlock button on the smart key, all doors will unlock.

Once the doors are unlocked, they may be opened by pulling the door handle.

When closing the door, push the door by hand. Make sure that doors are closed securely.

For more information, refer to the “Smart key” in the previous pages.

i Information

- In cold and wet climates, door lock and door mechanisms may not work properly due to freezing conditions.
- If the door is locked/unlocked multiple times in rapid succession with either the vehicle key or door lock switch, the system may stop operating temporarily in order to protect the circuit and prevent damage to system components.

Operating door locks from inside the vehicle

With the door lock button

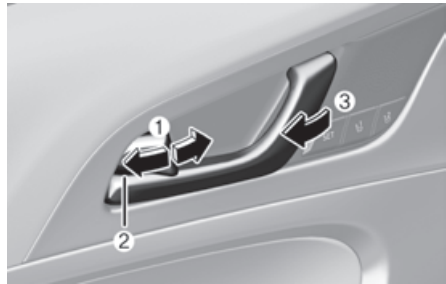

- To unlock a door, push the door lock button (1) to the “Unlock” position. The red mark (2) on the door lock button will be visible.
- To lock a door, push the door lock button (1) to the “Lock” position. If the door is locked properly, the red mark (2) on the door lock button will not be visible.
- To open a door, pull the door handle (3) outward.
- If the inner door handle of the driver’s (or front passenger’s) door is pulled when the door lock button is in the lock position, the button is unlocked and the door opens.
- Doors cannot be locked if the smart key is in the vehicle and any door is open.

WARNING

- When exiting the vehicle, pay attention to vehicles, motorcycles, bicycles, and pedestrians approaching from behind while opening the door. It is dangerous to open the door suddenly.
- Make sure the doors are securely closed before driving the vehicle. It is very dangerous if the door is opened while driving.
- Do not leave children or animals in the vehicle, who cannot get out of the vehicle on their own. Not only the temperature changes rapidly depending on the outside temperature, but also there is a risk of suffocation in a closed car, which can lead to serious injury or death if left in the car for a long time.
- Even if the door is locked, the front door will open just by pulling the inside door handle. Do not open the vehicle door while driving as it is very dangerous. It may cause injury or death.



i Information

When the vehicle's battery run out and you leave the vehicle, make sure all the doors are locked. You can lock the driver's door with a key and the rest of the doors with the lock button above the door inside handle.

With the central door lock switch



Driver door

The driver and passenger side door armrest is equipped with a central door lock switch. The lock switch is indicated by a  symbol. The unlock switch is indicated by a  symbol.

When the lock switch (1) is pressed, all the vehicle doors will lock.

When the unlock switch (2) is pressed, all the vehicle doors will unlock.

If the smart key is in the vehicle and any door is open, the doors will not lock even though the lock switch (1) is pressed.

i Information

If a power door lock ever fails to function while you are in the vehicle try one or more of the following techniques to exit:

- Operate the door unlock feature repeatedly (both electronic and manual) while simultaneously pulling on the door handle.
- Operate the other door locks and handles, front and rear.
- Lower a front window and use the mechanical key to unlock the door from outside.

 **WARNING**

- The doors should always be fully closed and locked while the vehicle is in motion. If the doors are unlocked, the risk of being thrown from the vehicle in a crash is increased.
 - Do not pull the inner door handle of the driver's or passenger's door while the vehicle is moving.
-

 **WARNING**

Do not leave the elderly, children or animals unattended in your vehicle. An enclosed vehicle can become extremely hot, causing death or serious injury to the elderly, unattended children or animals who cannot escape from the vehicle. Children might operate features of the vehicle that could injure them, or they could encounter other harm, possibly from someone gaining entry to the vehicle.

 **WARNING**

Always secure your vehicle.

Leaving your vehicle unlocked increases the potential risk to you or others from someone hiding in your vehicle.

To secure your vehicle, while depressing the brake pedal, shift the vehicle to P (Park), apply the parking brake, and press the Engine Start/Stop button to the OFF position, close all windows, lock all doors, and always take the smart key with you.

 **CAUTION**

Opening a door when something is approaching may cause damage or injury. Be careful when opening doors and watch for vehicles, motorcycles, bicycles or pedestrians approaching the vehicle in the path of the door.

 **WARNING**

If you stay in the vehicle for a long time while the weather is very hot or cold, there are risks of injuries or danger to life. Do not lock the vehicle from the outside when someone is in the vehicle.

Impact sensing door unlock system

All doors are automatically unlocked when an impact causes the airbags to deploy.

Speed sensing door lock system

All doors are automatically locked when the vehicle exceeds 15 km/h (9 mph).

Automatic door lock and unlock features

+ if equipped

Your vehicle is equipped with features that will automatically lock or unlock your vehicle based on settings you select in the infotainment system.

Auto lock enable on shift

When this feature is set in the infotainment system, all the doors will be locked automatically when the vehicle is shifted out of P (Park) while the engine is running.

Auto unlock on shift to P

When this feature is set in the infotainment system, all the doors will be unlocked automatically when the vehicle is shifted back to P (Park) while the engine is running.

Auto UNLOCK Vehicle off

When this feature is set in the infotainment system, all the doors will be unlocked automatically when the vehicle is turned off.

***i* Information**

The infotainment system may change after software updates. For more information, refer to the manual provided in the infotainment system and the quick reference guide.

Child-protector rear door locks

+ if equipped

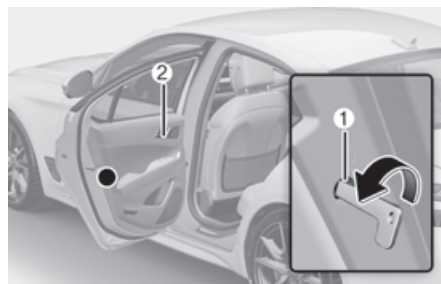

The child safety lock is provided to help prevent children seated in the rear from accidentally opening the rear doors. The rear door safety locks should be used whenever children are in the vehicle.

The child safety lock is located on the edge of each rear door. When the child safety lock is in the lock position, the rear door will not open if the inner door handle (2) is pulled.

To lock the child safety lock, insert a small flat blade tool (like a screwdriver or similar) (1) into the slot and turn it to the lock position as shown.

To allow a rear door to be opened from inside the vehicle, unlock the child safety lock.

⚠ WARNING

If children accidentally open the rear doors while the vehicle is in motion, they could fall out of the vehicle. The rear door safety locks should always be used whenever children are in the vehicle.

Theft-alarm system

This system helps to protect your vehicle and valuables. The horn will sound and the hazard warning lights will blink continuously if any of the following occur:

- A door is opened without using the smart key.
- The trunk (or tailgate) is opened without using the smart key.
- The engine hood is opened.

The alarm continues for 30 seconds, then the system resets. To turn off the alarm, unlock the doors with the smart key.

The Theft Alarm System automatically sets 30 seconds after you lock the doors and the trunk (or tailgate). For the system to activate, you must lock the doors and the trunk (or tailgate) from outside the vehicle with the smart key or by touching the touch sensor on the outside door handle with the smart key in your possession.

The hazard warning lights will blink and the chime will sound once to indicate the system is armed.

Once the security system is set, opening any door, the trunk (or tailgate), or the hood without using the smart key will cause the alarm to activate.

The Theft Alarm System will not set if the hood, the trunk (or tailgate), or any door is not fully closed. If the system will not set, check the hood, the trunk (or tailgate), or the doors are fully closed.

Do not attempt to alter this system or add other devices to it.

i Information

- Do not lock the doors until all passengers have left the vehicle. If the remaining passenger leaves the vehicle when the system is armed, the alarm will be activated.
 - If the vehicle is not disarmed with the smart key, open the doors by using the mechanical key and start the engine by directly pressing the Engine Start/Stop button with the smart key.
 - If the system is disarmed by unlocking the vehicle, but neither a door or the trunk (or tailgate) is opened within 30 seconds, the doors will relock and the system will rearm automatically.
 - It is not recommended to install any secondary aftermarket theft-alarm systems into the vehicle factory electrical system.
-

i Information



Vehicles equipped with a theft alarm system will have a label attached to the vehicle with the following words:

- (1) WARNING
 - (2) SECURITY SYSTEM
-

Rear Occupant Alert (ROA)

Rear Occupant Alert is provided to help prevent the driver from leaving the vehicle with the rear passenger left in the vehicle.

System setting

To use Rear Occupant Alert, it must be enabled from the Settings menu in the infotainment system. Select:

- **Setup (Settings) >Vehicle > Convenience > Rear Occupant Alert**

i Information

The infotainment system may change after software updates. For more information, refer to the manual provided in the infotainment system and the quick reference guide.

System operation

Alert

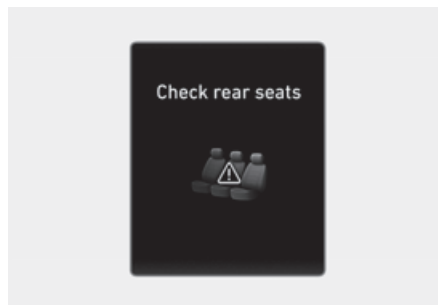

When you turn off the engine and open the driver's door after opening and closing the rear door, the "**Check rear seats**" warning message appears on the instrument cluster.

! WARNING

Rear Occupant Alert provides information to the driver to check the rear seats but it does not detect whether there is an object or passenger in the back seats. Always make sure to check the rear seats before you leave the vehicle.

! CAUTION

The door open and close history is initialized when the driver turns off the engine and locks the vehicle door. Even though the rear door is not opened again, an alert may occur if the previous history is not initialized. For example, if the driver does not lock the vehicle door and opens the door to get off after the alert sounds, the alert may go off.

Integrated memory system



Integrated Memory System for the driver's seat is provided to store and recall the following memory settings with a simple button operation.

- Driver's seat position
- Steering wheel position (power adjustment)
- Outside rearview mirror position
- Head-Up Display (HUD) position (if equipped)

WARNING

Never attempt to operate the integrated memory system while the vehicle is moving.

This could result in loss of control, and an accident causing death, serious injury, or property damage.

Information

- If the battery is disconnected, the memory settings will be erased.
 - If integrated memory system does not operate normally, we recommend that you have the system inspected by an authorized retailer of Genesis Branded products.
-

Storing memory positions

1. Shift to P (Park) while the Engine Start/Stop button is in the ON position.
2. Adjust the driver's seat position, outside rearview mirror position, steering wheel position, and head-up display height/brightness to the desired position.
3. Press the **SET** button. The system will beep once and notify you "**Press button to save settings**" on the cluster display.
4. Press one of the memory buttons (**1** or **2**) within 4 seconds. The system will beep twice when the memory has been successfully stored.
5. "**Settings 1(or 2) saved**" will appear on the cluster display. The message appears only for the driver's seat position memory setting.

Recalling memory positions

1. Shift to P (Park) while the Engine Start/Stop button is in the ON position.
2. Press the desired memory button (1 or 2). The system will beep once, and then the driver's seat position, outside rearview mirror position, steering wheel position, and head-up display height/brightness will automatically adjust to the stored positions.
3. **"Settings 1(or 2) applied"** will appear on the cluster display.

i Information

- If you press the SET button or the corresponding button which the setting is being recalled, the setting will temporarily deactivate. If you press the other buttons, the setting of the pressed button will activate.
For example, if you press the SET button or number 1 button with the number 1 setting in operation, the setting will temporarily deactivate. If you press the number 2 button, the number 2 setting will activate.
- If you adjust the seat, rearview mirror, steering wheel, instrument panel illumination or head-up display while recalling the stored positions, the pre-set settings will become ineffective.

Resetting the system

Take the following procedures to reset integrated memory system, when it does not operate properly.

Resetting integrated memory system

1. Stop the vehicle and open the driver's door with the engine on and the vehicle shifted to P (Park).
2. Adjust the driver's seat and seatback to the foremost position.
3. Press the SET button and push forward the driver's seat switch simultaneously (about two seconds).
4. Release the SET button and the driver's seat switch when a beep sounds.

While resetting integrated memory system

1. Resetting starts with a notification sound.
2. The driver's seat and seatback is adjusted to the rearward position with the notification sound.
3. The driver's seat and seatback is re-adjusted to the default position (central position) with the notification sound.

However, in the following cases, the resetting procedure and the notification sound may stop.

- The memory button is pressed.
- The seat control switch is operated.
- The gear is shifted out of P (Park).
- The driving speed exceeds 3 km/h (2 mph).
- The driver's door is closed.

NOTICE

- While integrated memory system is being reset, if the resetting and notification sound stops incompletely, restart the resetting procedure again.
 - Make sure that there is no objects around the driver's seat in advance of resetting the integrated memory system.
-

Seat easy access

Seat easy access will move the driver's seat and steering wheel automatically as follows:

- Exiting the vehicle:
The driver's seat, steering wheel and seat bolster will move as follows when the Engine Start/Stop button is in the OFF position with the gear in P (Park) and the driver's door open.
 - Driver seat: Moves rearward depending on the distance selected from the Settings menu in the infotainment system.
 - Steering wheel: Moves upward
 - Seat bolster (if equipped): Adjusted to the default position.

However, the driver's seat may not move rearward if there is not enough space between the driver's seat and the rear seats.

Also, on a regular basis, the steering wheel will also move forward to adjust its location by itself.

- Entering the vehicle:
The driver's seat, steering wheel and seat bolster will move as follows when the Engine Start/Stop button is pressed to the ACC, ON or START position or while carrying the smart key, the driver's door is closed with the Engine Start/Stop button in the OFF position.
 - Driver seat: Moves back to its original position.
 - Steering wheel: Moves back to its original position.
 - Seat bolster (if equipped): Adjusted to the last position set by you.
- You can set the Seat Easy Access function from the Settings menu in the infotainment system. Select:
 - Driver seat
Setup (Settings) > Vehicle > Seat > Seating Easy Access > Easy seat access > Extended/Normal/Off
 - Steering wheel
Setup (Settings) > Vehicle > Seat > Seating Easy Access > Easy steering access

i Information

The infotainment system may change after software updates. For more information, refer to the manual provided in the infotainment system and the quick reference guide.

Steering wheel

Motor Driven Power Steering (MDPS)

The system assists you with steering the vehicle. If the vehicle is turned off or if the power steering system becomes inoperative, you may still steer the vehicle, but it will require increased steering effort.

Should you notice any change in the effort required to steer during normal vehicle operation, we recommend that you have the system checked by an authorized retailer of Genesis Branded products.

CAUTION

If the Motor Driven Power Steering does not operate normally, the  warning light and the message “**Check motor driven power steering**” will illuminate on the instrument cluster. You may steer the vehicle, but it will require increased steering efforts. We recommend that you take the vehicle to an authorized retailer of Genesis Branded products and have the system checked as soon as possible.

i Information

The following symptoms may occur during normal vehicle operation:

- The steering effort may be high immediately after pressing the Engine Start/Stop button to the ON position. This happens as the system performs the MDPS system diagnostics. When the diagnostics are completed, the steering wheel effort returns to its normal condition.
- When the 12 V battery voltage is low, you may have to use more effort to steer. This is a temporary condition and returns to normal after charging the battery.
- A noise may be heard from the MDPS relay after the Engine Start/Stop button is in the ON or OFF position.
- Motor noise may be heard when the vehicle is at a stop or at a low speeds.
- When you operate the steering wheel in low temperatures, abnormal noise may occur. If the temperature rises, the noise disappears. This is a normal condition.
- When an error is detected from MDPS, the steering effort assist function is not activated. Instrument cluster warning lights may illuminate or the steering effort may be high. If these symptoms occur, drive the vehicle to a safe location as soon as possible. We recommend that you have the system checked by an authorized retailer of Genesis Branded products as soon as possible.

Tilt/Telescopic steering

When adjusting the steering wheel to a comfortable position, adjust the steering wheel so that it points toward your chest, not toward your face. Make sure you can see the instrument cluster warning lights and gauges. After adjusting, push the steering wheel both up and down to be certain it is locked in position.

Always adjust the position of the steering wheel before driving.

WARNING

Never adjust the steering wheel while driving. This may cause loss of vehicle control resulting in an accident.

NOTICE

While adjusting the steering wheel height, please do not push or pull it hard since the fixture can be damaged.

Manual adjustment

 If equipped

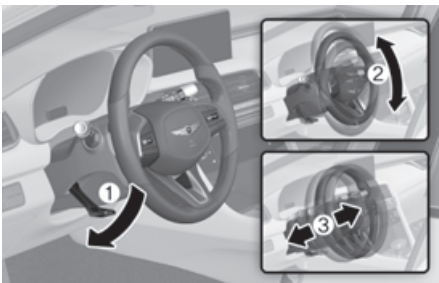

To adjust the steering wheel angle and height:

1. Pull down the lock-release lever (1).
2. Adjust the steering wheel to the desired angle (2) and distance forward/back (3).
3. Pull up the lock-release lever to lock the steering wheel in place.

i Information

Sometimes the lock release lever may not engage completely. This may occur when the gears of the locking mechanism do not completely mesh. If this occurs, pull down on the lock-release lever, readjust the steering wheel again, and then pull back up on the release lever to lock the steering wheel in place.

Power adjustment

 If equipped

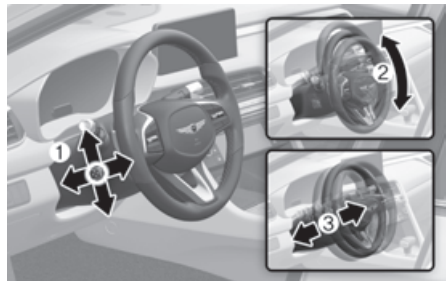

To change the steering wheel angle and height:

- Push the switch (1) up and down to adjust the angle (2).
- Push the switch forward or rearward to adjust the height (3).

NOTICE

Do not adjust the steering wheel longer than necessary when the engine is turned off. This may result in unnecessary battery drain.

Resetting steering wheel power adjustment

If adjustment is no longer possible within the operable range while adjusting the steering wheel position (angle or height), reset as follows.

1. From the position the steering wheel has stopped, push the control switch (1) for 10 seconds in the direction you were adjusting the steering wheel. The steering wheel will move in the direction the control switch is pushed.
2. Continue pushing the switch (1) for at least 2 seconds after the steering wheel has stopped. Resetting will be complete after the operational range is recognized.

If the adjustment is still not possible after resetting the steering wheel power adjustment, we recommend that the system be inspected by authorized retailer of Genesis Branded products.

Horn



To sound the horn, press the area indicated by the horn symbol on your steering wheel (see illustration). The horn will operate only when this area is pressed.

NOTICE

Do not strike the horn severely to operate it, or hit it with your fist. Do not press on the horn with a sharp-pointed object.

Heated steering wheel

 If equipped



While the engine is running, touch the heated steering wheel icon to warm the steering wheel.

- Manual temperature control
Each time you touch the icon, the temperature setting of the steering wheel changes as follows:
 - OFF > LOW > HIGH > OFF
- Automatic temperature control
The heated steering wheel starts to automatically control the steering wheel temperature after being manually turned ON.
 - When HIGH is manually selected:
The heated steering wheel automatically changes to the LOW position after 30 minutes. You can turn off the heated steering wheel by touching the icon to the OFF position.
 - When LOW is manually selected:
The heated steering wheel will not be controlled manually.

- **Warmer/ventilation based on climate settings** (for driver's seat)

The heated steering wheel automatically controls the steering wheel temperature depending on the ambient temperature when the engine is running.

If you touch the heated steering wheel icon, the heated steering wheel will have to be controlled manually.

To use this function, it must be enabled from the Settings menu in the infotainment system.

Select: **Setup (Settings) > Vehicle > Seat** (or **Climate**) > **Warmer/Ventilation Features > Warmer/ventilation based on climate settings > Steering Wheel Warmer**

Information

The infotainment system may change after software updates. For more information, refer to the manual provided in the infotainment system and the quick reference guide.

- The heated steering wheel defaults to the OFF position whenever the Engine Start/Stop button is pressed to the ON position. However, if the **Warmer/ventilation based on climate settings** function is ON, the heated steering wheel will turn on and off depending on the outside temperature.

NOTICE

Do not install any cover or accessory on the steering wheel. The cover or accessory could cause damage to the heated steering wheel system.

Mirrors

Inside rearview mirror

Before driving your vehicle, check to see that your inside rearview mirror is properly positioned. Adjust the rearview mirror so that the view through the rear window is properly centered.

WARNING

Make sure your line of sight is not obstructed. Do not place objects in the rear seat, cargo area, or behind the rear headrests which could interfere with your vision through the rear window.

WARNING

To prevent serious injury during an accident or deployment of the airbag, do not modify the rearview mirror and do not install a wide mirror.

WARNING

Never adjust the mirror while driving. This may cause loss of vehicle control resulting in an accident.

NOTICE

When cleaning the mirror, use a paper towel or similar material dampened with glass cleaner. Do not spray glass cleaner directly on the mirror as this may cause the liquid cleaner to enter the mirror housing.

Day/night rearview mirror

 if equipped



Make this adjustment before you start driving and while the day/night lever is in the day position.

Pull the day/night lever towards you to reduce glare from the headlamps of the vehicles behind you during night driving.

Remember that you lose some rearview clarity in the night position.

Electrochromic mirror (ECM)

 if equipped

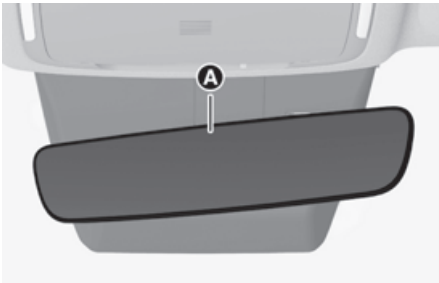

[A] Sensor

Some vehicles come equipped with an Electrochromic mirror that helps control glare while driving at night or under low light driving conditions.

When the engine is running, the glare is automatically controlled by the sensor mounted in the rearview mirror. The sensor detects the light level around the vehicle, and automatically adjusts to control the headlight glare from vehicles behind you.

Whenever the gear is shifted to R (Reverse), the mirror will automatically go to the brightest setting in order to improve the driver's view behind the vehicle.

Electrochromic mirror (ECM) with HomeLink® system

 if equipped

Your vehicle may be equipped with a Gentex Automatic-Dimming Mirror with an Integrated HomeLink® Wireless Control System.

During nighttime driving, this feature will automatically detect and reduce rearview mirror glare. The HomeLink® Universal Transceiver allows you to activate your garage door(s), electric gate, home lighting, etc.

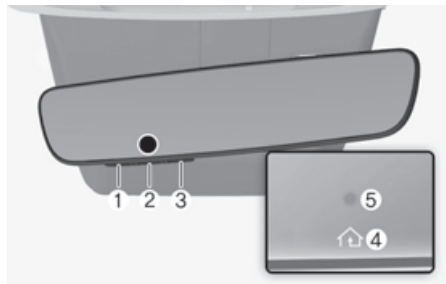

- (1) HomeLink Channel 1
- (2) HomeLink Channel 2
- (3) HomeLink Channel 3
- (4) HomeLink Operation Indicator
- (5) HomeLink User Interface Indicator

Automatic-Dimming Night Vision Safety™ (NVS®) Mirror

 if equipped

The NVS® Mirror automatically reduces glare by monitoring light levels in the front and the rear of the vehicle. Any object that obstructs either light sensor will degrade the automatic dimming control feature.

For more information regarding NVS® mirrors and other applications, refer to the Gentex website:

www.gentex.com

Your mirror will automatically dim upon detecting glare from the vehicles traveling behind you.

The mirror defaults to the ON position each time the vehicle is started.

Integrated HomeLink® Wireless Control System

The HomeLink® Wireless Control System provides a convenient way to replace up to three handheld radio-frequency transmitters used to activate compatible devices such as gate operators, garage door openers, entry door locks, security systems, and home lighting.

NOTICE

HomeLink® operates while the Start/Stop button is in the ACC or ON position for safety reasons. It is to prevent unintentional security problems from happening when the vehicle is parked outside the garage.

WARNING

Before programming HomeLink® to a garage door opener or gate operator, make sure people and objects are out of the way of the device to prevent potential harm or damage.

It is also recommended that a new battery be replaced in the handheld transmitter of the device being trained to HomeLink® for quicker training and accurate transmission of the radio frequency.

For more information, contact HomeLink® at www.homelink.com, or call Home-Link customer support

It is also recommended that a new battery be replaced in the handheld transmitter of the device being trained to HomeLink® for quicker training and accurate transmission of the radio frequency.

Information

Home-Link customer support information

- (0) 0800 046 635 465 (depending on your carrier, the toll free number may not be available)
- (0) 08000 HOMELINK or alternatively +49 7132 3455 733 (subject to charge). (Have the vehicle maker/model and the opener device maker/model readily available.)

1. Programming HomeLink®

The following steps show how to program HomeLink. If you have any questions or are having difficulty programming your HomeLink buttons, refer to the HomeLink website or call the HomeLink customer support toll-free number. Do this, before going back to the dealer who sold you the vehicle.

- Visit the HomeLink website at: www.homelink.com. Then at the top of the page, choose your vehicle maker. Then watch the YouTube video, and/or access additional website information.
- Call HomeLink customer support

1) Programming Preparation

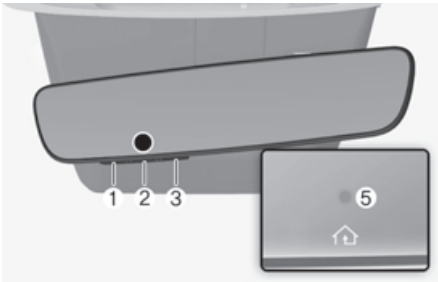

1. When programming a garage door opener, it is advised to park the vehicle outside of the garage.
2. It is recommended that a new battery be placed in the handheld transmitter of the device being programmed to HomeLink for quicker training and accurate transmission of the radio-frequency signal.
3. Press the Start/Stop button to the ACC (Accessory) or ON position for programming of HomeLink.

2) Programming a New HomeLink®

1. Press and release the HomeLink button (1), (2) or (3), you would like to program. The HomeLink indicator light (5) will flash orange slowly (if not, perform the steps of “Erasing HomeLink Buttons” section, and start over).

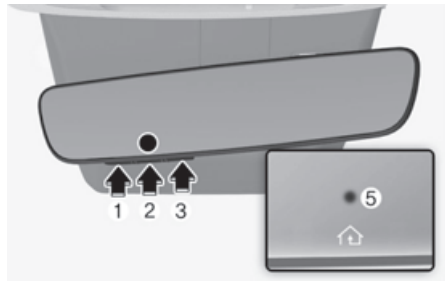

2. Position the garage door opener remote 2-8 cm (1-3 in.) away from the HomeLink buttons.



3. While the HomeLink indicator light (5) is flashing orange, press and hold the handheld remote button. Continue pressing the handheld remote button until the HomeLink indicator light (5) light changes from orange to green. You may now release the handheld remote button.

4. Wait until your garage door comes to a complete stop, regardless of position, before proceeding to the next steps.
5. Press and release the HomeLink button you are programming and observe the indicator light.
 - If the indicator light remains solid green, your device should operate when the HomeLink button is pressed. At this point, if your device operates, programming is complete.
 - If the indicator light rapidly flashes green, firmly press, hold for three seconds and release the HomeLink button up to three times in a row slowly to complete the programming process. Do not press the HomeLink button rapidly. At this point if your device operates, programming is complete. If the device does not operate, continue with step 6.
6. At the garage door opener motor, (security gate motor, etc.) locate the **Learn, Smart, Set or Program** button. This can usually be found where the hanging antenna wire is attached to the motor-head unit (see the device's manual to identify this button). The name and color of the button may differ by manufacturer.

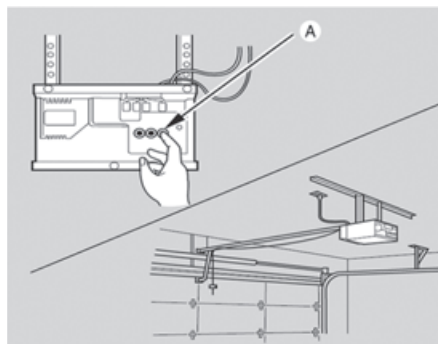

[A] Learn button

- A ladder and/or second person may simplify the following steps.
7. Firmly press and release the **Learn, Smart, Set or Program** button. You now have up to 30 seconds in which to complete the next step.
 8. Return to the vehicle and firmly press, hold for three seconds and release, the HomeLink button up to three times in a row slowly. Do not press the HomeLink button rapidly. As soon as you see the garage door start to move, stop pressing any buttons until a few seconds after the garage door has come to a complete stop, regardless of position. At this point, programming is complete and your device should operate when the HomeLink button is pressed and released.

2. Operating HomeLink®

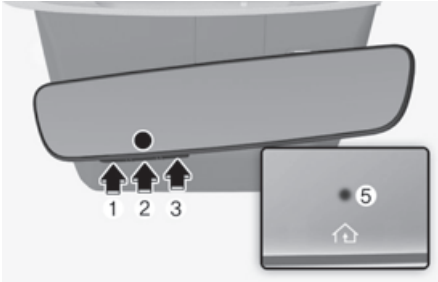

1. Press and release the desired programmed HomeLink button (1, 2 or 3).

i Information

The HomeLink indicator (5) should light green, solid or flashing, and your programmed device should operate.

If your device does not operate, the HomeLink programming was not successful, and you'll need to reprogram the button.

3. Erasing and Reprogramming HomeLink® Buttons

1) Reprogramming a Single HomeLink® Button:

1. Press and hold the desired HomeLink button you want to re-program. DO NOT release the button.
2. The HomeLink indicator light (5) will illuminate solid green. Release the button as soon as the HomeLink indicator light (5) begins to flash orange, usually about 20 seconds.
3. Proceed with the steps in the "Programming a New HomeLink Button" section.

i Information

If you do not complete the re-programming of a new device to the button, it will revert to the previously stored programming.

2) The following instructions will erase ALL HomeLink® programming from ALL buttons:

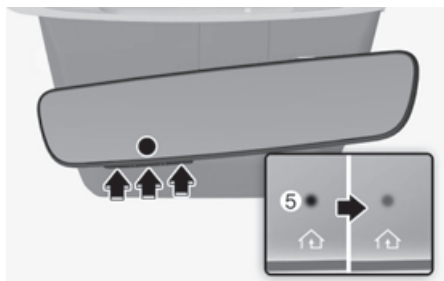

1. Press and hold the buttons (1) and (3) simultaneously
2. The HomeLink indicator light (5) will illuminate solid Orange for about 10 seconds
3. Release the buttons once the HomeLink indicator light (5) changes to Green and flashes rapidly
4. Now all three HomeLink buttons (1), (2) and (3) are cleared of any programming

i Information

HomeLink® and the HomeLink® House logo are registered trademarks of Gentex Corporation.

The myQ logo is a registered trademark of The Chamberlain Group, Inc.

European Union

English Version of Text listed below.
Other languages are available on request.

Hereby, Gentex Corporation declares that HomeLink® Model UAHL50 is in compliance with Radio Equipment Directive 2014/53/EU. The full text of the EU Declaration of Conformity is available at the following internet address:
<http://www.homelink.com/regulatory>

Frequency Bands in which the radio equipment operates:

- 433.05MHz-434.79MHz, 2.01mW E.R.P.
- 868.00MHz-868.60MHz, 3.34mW E.R.P.
- 868.70MHz-869.20MHz, 3.13mW E.R.P.

Certificate Holder's Address:
Gentex Corporation
600 North Centennial Street
Zeeland MI 49464
USA

United Kingdom

Hereby, Gentex Corporation declares that HomeLink® Model UAHL50 is in compliance with the Radio Equipment Regulations 2017 (S.I. 2017/1206). The full text of the UK Declaration of Conformity is available at the following internet address:

<http://www.homelink.com/regulatory>

Frequency Bands in which the radio equipment operates:

- 433.05MHz-434.79MHz, 2.01mW E.R.P.
- 868.00MHz-868.60MHz, 3.34mW E.R.P.
- 868.70MHz-869.20MHz, 3.13mW E.R.P.

Certificate Holder's Address:

Gentex Corporation
600 North Centennial Street
Zeeland MI 49464
USA

HomeLink 5 Programing Flow Chart

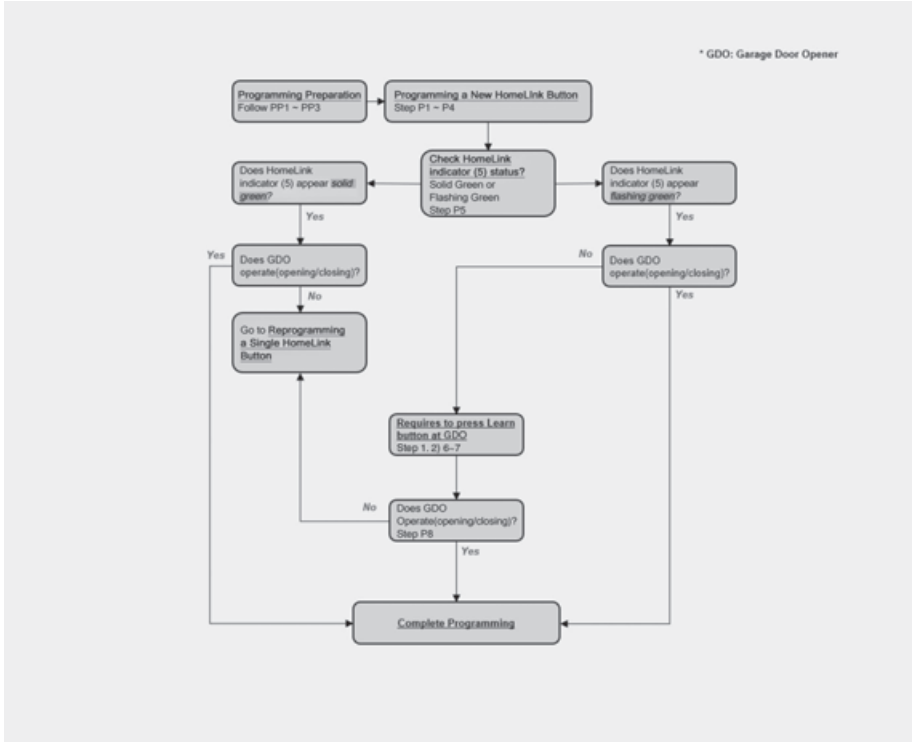

Outside rearview mirrors



Your vehicle is equipped with both left-hand and right-hand outside rearview mirrors. The mirrors can be adjusted remotely with the remote switch. The outside rearview mirrors can be folded to help prevent damage when going through an automatic car wash or when passing through a narrow street.

The left and right outside rearview mirrors are convex. Objects seen in the mirror are closer than they appear.

Use the inside rearview mirror or look back directly to determine the actual distance of other vehicles prior to changing lanes.

Make sure to adjust the outside rearview mirrors to your desired position before you begin driving.

WARNING

Do not adjust or fold the outside rearview mirrors while driving. This may cause loss of vehicle control resulting in an accident.

NOTICE

- Do not scrape ice off the mirror face; this may damage the surface of the glass.
 - If the mirror is jammed with ice, do not adjust the mirror by force. Use an approved de-icer (not radiator antifreeze) spray, or a sponge or soft cloth with very warm water, or move the vehicle to a warm place and allow the ice to melt.
 - Do not clean the mirror with harsh abrasives, fuel or other petroleum based cleaning products.
-

Adjusting the outside rearview mirrors



Adjusting the outside rearview mirrors:

1. Move the lever (1) either to the L (left side) or R (right side) to select the outside rearview mirrors you would like to adjust.
2. Use the mirror adjustment control switch (2) to position the selected mirror up, down, left or right.
3. After adjustment, move the lever (1) to the middle to prevent inadvertent adjustment.

NOTICE

- The mirrors stop moving when they reach the maximum adjusting angles, but the motor continues to operate while the switch is pressed. Do not press the switch longer than necessary, because this can damage the motor.
- Do not attempt to adjust the outside rearview mirrors by hand, because this can damage the motor.

Folding the outside rearview mirrors

if equipped



Folding button

The rearview mirrors can be folded or unfolded by pressing the button.

Infotainment system setting

- Enable on door unlock
 - If **Setup (Settings) > Vehicle > Light > Welcome mirror/light > on door unlock** is selected from the Settings menu in the infotainment system,
 - The mirror will fold or unfold when the door is locked or unlocked by the smart key.
 - The mirror will fold or unfold when the door is locked or unlocked by the touch sensor on the outside door handle.
- Enable on driver approach
 - If **Setup (Settings) > Vehicle > Light > Welcome mirror/light > On driver approach** is selected from the Settings menu in the infotainment system, the mirror will unfold when the vehicle is approached with the smart key in possession.

i Information

The infotainment system may change after software updates. For more information, refer to the manual provided in the infotainment system and the quick reference guide.

NOTICE

The electric type outside rearview mirror operates even though the Engine Start/Stop button is in the OFF position. However, to prevent unnecessary battery discharge, do not adjust the mirrors longer than necessary while the engine is not running.

NOTICE

Do not fold the electric type outside rearview mirror by hand. It could cause motor failure.

Reverse parking aid

 If equipped

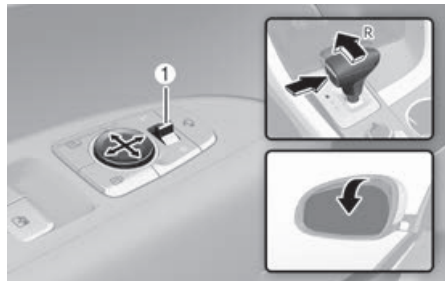

When the gear is shifted to the R (Reverse) position, the outside rearview mirror(s) will rotate downwards to aid with driving in reverse.

The state of the outside rearview mirror switch (1) determines whether or not the mirrors will move:

How it works

- When either the L (Left) or R (Right) side is selected, both outside rearview mirrors will move.
- When neither side is selected, the outside rearview mirrors will not move.

The outside rearview mirrors will automatically revert to their original positions if any of the following occur:

- The Engine Start/Stop button is pressed to either the OFF position or the ACC position.
- The gear is shifted to any position except R (Reverse).
- The outside rearview mirror adjustment switch is not selected.

Reverse parking aid user settings mode

You may change the angle of the outside rearview mirror if it is difficult to see the rear view with the basic downward mirror angle provided when reversing.

When the vehicle is first delivered, the set downward angle of the left and right outside rearview mirror are different to ensure driver visibility.

1. Make sure the vehicle is stopped.
2. Depress the brake pedal and shift the gear to R (Reverse). When L (Left) or R (Right) side is selected, both outside rearview mirror angle will move downward to the basic set position.
3. Move the lever to L or R to select the outside rearview mirror you would like to adjust. Then press “▼, ▲, ◀, ▶” switch to adjust the outside rearview mirror to the desired angle.
4. After adjusting the angle to save the adjusted outside rearview mirror angle, shift the gear to another position other than R (Reverse), or change the L and R switch to the neutral position (L and R switch is not pressed).
5. Set the other outside rearview mirror following the above procedure 1 to 4.

Resetting reverse parking aid user settings mode

To change the outside rearview mirror angle back to the basic angle, shift the gear to R (Reverse), and adjust the mirror angle higher than when the gear is in P (Park), N (Neutral) and D (Drive).

***i* Information**

When changing the angle of both outside rearview mirrors, it is recommended to change the angle one side at a time following the procedure 1 to 4.

Windows

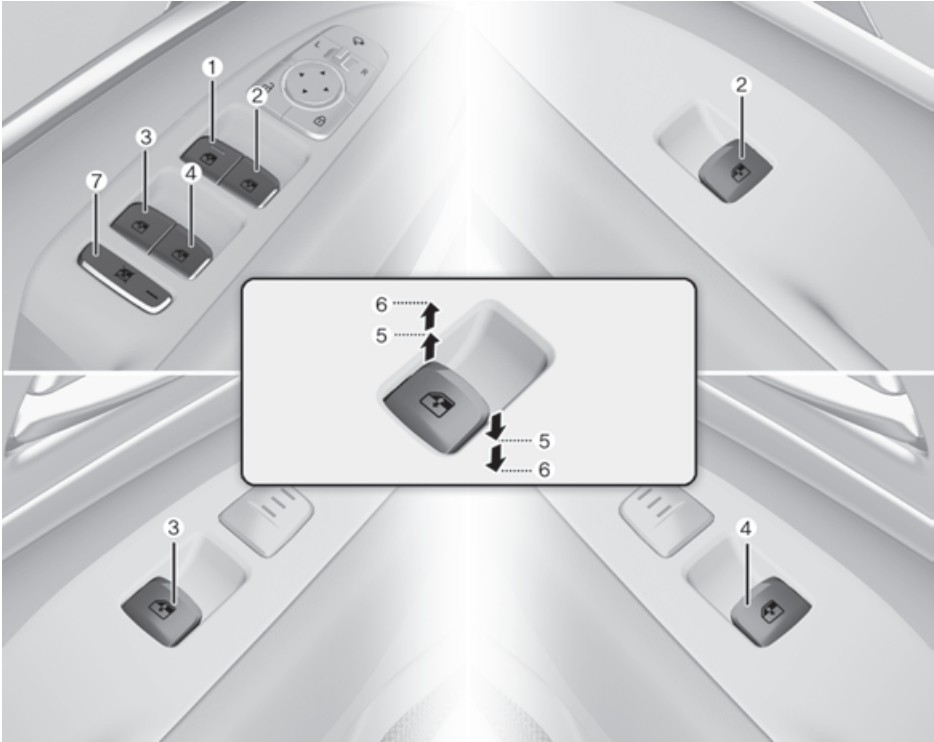

- (1) Driver's door power window switch
- (2) Front passenger's door power window switch
- (3) Rear door (left) power window switch
- (4) Rear door (right) power window switch
- (5) Window opening and closing
- (6) Automatic power window
- (7) Power window lock switch

Power windows

The Engine Start/Stop button must be in the ON position to be able to raise or lower the windows. Each door has a Power Window switch to control that door's window. The driver has a Power Window Lock button which can block the operation of passenger windows. The power windows will operate for about 3 minutes after the Engine Start/Stop button is in the ACC or OFF position. However, if the front doors are opened, the Power Windows will not operate even within the 3 minute period.

Window opening and closing

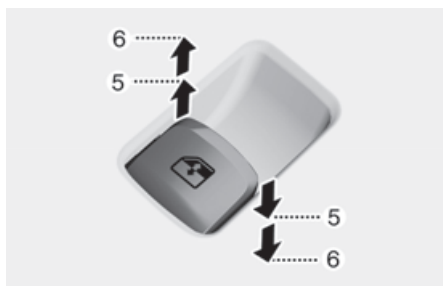

To open:

Press the window switch down to the first detent position (5). Release the switch when you want the window to stop.

To close:

Pull the window switch up to the first detent position (5). Release the window switch when you want the window to stop.

Auto up/down window

Pressing or pulling up the power window switch momentarily to the second detent position (6) completely lowers or lifts the window even when the switch is released. To stop the window at the desired position while the window is in operation, pull up or press down and release the switch.

Resetting the power windows

If the power windows do not operate normally, the automatic power window system must be reset as follows:

1. Press the Engine Start/Stop button to the ON position.
2. Close the window and continue pulling up on the power window switch for at least one second.

If the power windows do not operate properly after resetting, we recommend that the system be inspected by an authorized retailer of Genesis Branded products.

WARNING

The automatic reverse feature doesn't activate while resetting the power window system. Make sure body parts or other objects are safely out of the way before closing the windows to avoid injuries or vehicle damage.

Automatic reverse

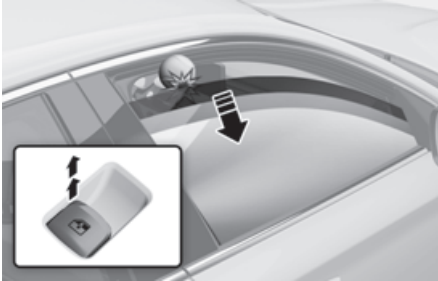

If a window senses any obstacle while it is closing automatically, it will stop and lower about 30 cm (12 in.) to allow the object to be cleared.

If the window detects the resistance while the power window switch is pulled up continuously, the window will stop upward movement then lower about 2.5 cm (1 in.).

If the power window switch is pulled up continuously again within 5 seconds after the window is lowered by the automatic window reverse feature, the automatic window reverse will not operate.

***i* Information**

The automatic reverse feature is only active when the “Auto Up” feature is used by fully pulling up the switch to the second detent.

WARNING

Make sure body parts or other objects are safely out of the way before closing the windows to avoid injuries or vehicle damage.

Objects less than 4 mm (0.16 in.) in diameter caught between the window glass and the upper window channel may not be detected by the automatic reverse window and the window will not stop and reverse direction.

Power window lock button



The driver can disable the power window switches on the rear passenger doors by pressing the power window lock button.

When the power window lock button is pressed:

- The rear passenger control will not be able to operate the rear passenger power window.
- Note that the front passenger control is still able to operate the front passenger window, and that the driver master control can still operate all the power windows.

WARNING

Do not allow children to play with the power windows. Keep the driver's door power window lock button in the LOCK position. Serious injury or death can result from unintentional window operation by a child.

NOTICE

- To prevent possible damage to the power window system, do not open or close two windows or more at the same time. This will also ensure the longevity of the fuse.
- Never try to operate the main switch on the driver's door and the individual door window switch in opposite directions at the same time. If this is done, the window will stop and cannot be opened or closed.

WARNING

- Never leave the keys in your vehicle with unsupervised children, when the engine is running.
- Never leave any child unattended in the vehicle. Even very young children may inadvertently cause the vehicle to move, entangle themselves in the windows, or otherwise injure themselves or others.
- Always double check to make sure all arms, hands, head and other obstructions are safely out of the way before closing a window.
- Do not allow children to play with the power windows. Keep the driver's door power window lock switch in the LOCK position (pressed). Serious injury can result from unintentional window operation by the child.
- Do not extend your head, arms or body outside the windows while driving.

Remote window opening/closing function

 If equipped

System settings

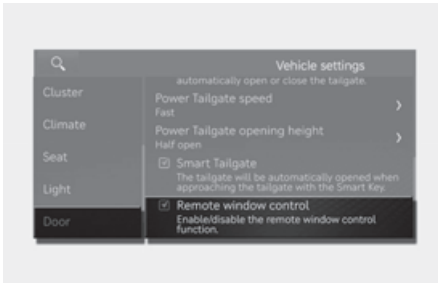

Select **Setup (Settings) > Vehicle > Door > Remote window control** from the Settings menu to control the window movement using the smart key.

Window opening and closing

You can still control the window movement with the vehicle turned off by pressing the Door Lock button (1) or the Door Unlock button (2).



- Press the Door Lock button (1) for more than 3 seconds. The window moves up, as long as you press the door lock button. The window movement stops, when you release the door lock button.

- Press the Door Unlock button (2) for more than 3 seconds. The window moves down after the doors are unlocked, as long as you press the door unlock button. The window movement stops, when you release the door unlock button.

Information

- The remote window opening/closing function may abruptly stop when you move away from your vehicle during operation. Stay in close proximity from your vehicle, whilst monitoring the window movement.
- One of the windows may stop operating when the window is interrupted by certain force. However, the other windows will keep operating. Make sure that all windows are closed.
- Be aware that the doors unlock when the windows are opened using the remote window open/closing function.

WARNING

Always double check to make sure arms, hands, head and other obstructions are safely out of the way before using remote window closing function.

Wide sunroof

 if equipped

If your vehicle is equipped with a sunroof, you can slide or tilt your sunroof with the sunroof switch located on the overhead console.



The sunroof can only be operated when the Engine Start/Stop button is in the ON or START position.

The sunroof can be operated for about 3 minutes after the Engine Start/Stop button is in the ACC or OFF position. If the front door is open, the sunroof cannot be operated even within the 3 minutes period.

WARNING

To prevent serious injury or death:

- Adjust the sunroof or sunshade when your vehicle stops.
- Do not leave the engine running and the key in your vehicle with unsupervised children. Unattended children could operate the sunroof.
- Do not sit on the top of the vehicle.

NOTICE

Do not operate the sunroof when roof bars are installed on the vehicle or when there is luggage on the roof.

Power sunshade



Use the power sunshade to block direct sunlight coming through the sunroof glass.

- Push the sunroof switch rearward to the first detent position, the power sunshade automatically slides open.
- Push the sunroof switch forward to the first detent position, the power sunshade automatically closes. If the sunroof glass is open, the glass closes and then the sunshade closes.

To stop the power sunshade at any point, push the sunroof switch in any direction.

NOTICE

Do not pull or push the power sunshade by hand to prevent damage.

i Information

Wrinkles formed on the power sunshade are normal due to material characteristic.

Tilt open/close



- Push the sunroof switch up and sunroof glass tilts open. If the power sunshade is closed, the sunshade opens first and then the sunroof tilts.
- Push the sunroof switch up or forward when the sunroof glass is tilt opened. The sunroof glass automatically closes.

To stop the sunroof movement at any point, push the sunroof switch in any direction.

Slide open/close



- Push the sunroof switch rearward to the first detent position. The sunroof glass opens. If the power sunshade is closed, the power sunshade opens first and then the sunroof glass opens.
- Push the sunroof switch forward to the first detent position. The sunroof glass closes. If the sunroof glass is closed, the power sunshade closes.
- Push the sunroof switch forward or rearward to the second detent position. The power sunshade and sunroof glass operate automatically (auto slide feature). To stop the sunroof movement at any point, push the sunroof switch in any direction.

Automatic reversal

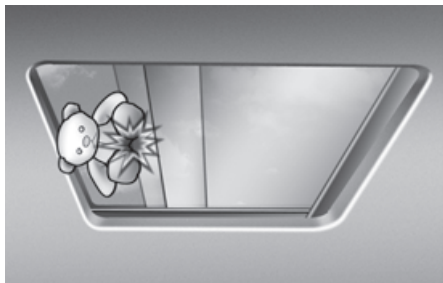

If the power sunshade or sunroof glass senses any obstruction while closing, it reverses direction then stops.

The automatic reverse function may not work if a thin or soft object is caught between the power sunshade or sliding sunroof glass and sunroof sash.

WARNING

- Make sure that heads, hands, arms or any other body parts or objects are out of the way before operating the sunroof. Body parts or objects may get caught causing injuries or vehicle damage.
- Never deliberately use your body parts to test the automatic reverse feature.

NOTICE

- Do not continue to push the sunroof switch after the sunroof is fully opened, closed, or tilted. Damage to the sunroof motor may occur or may cause the sunroof system to malfunction.
- Using the sunroof for a long time may make noise caused by dust accumulated between the sunroof and vehicle body. Open the sunroof and remove dust regularly using a clean cloth.
- Do not try to open the sunroof when the temperature is below freezing or when the sunroof is covered with snow or ice. Otherwise, the motor may be damaged. In a cold and wet weather, the sunroof may not work properly.
- Do not open or drive with the sunroof glass open immediately after rain or washing the vehicle. Water may wet the interior of the vehicle.
- Do not extend any cargo outside the sunroof while driving.

WARNING

Do not extend your head, arms, body parts, or objects outside the sunroof while driving. Injuries may occur if the vehicle suddenly stops.

Resetting the sunroof



In some circumstances resetting the sunroof operation may need to be performed. Some instances where resetting the sunroof may be required include:

- When the 12 V battery is either disconnected or discharged
- When the sunroof fuse is replaced
- If the sunroof one-touch AUTO OPEN/CLOSE operation is not functioning properly

To reset the sunroof:

1. Start the vehicle in P (Park).
2. Make sure the power sunshade and sunroof glass are in the fully closed position.
3. Release the switch when the power sunshade and sunroof glass is fully closed.
4. Push the switch forward until the power sunshade and sunroof glass moves slightly. Then release the switch.
5. Push and hold the sunroof switch forward again until the power sunshade and sunroof glass slide open and close.

Do not release the switch until the operation is completed. If you release the switch, start again from step 2.

i Information

If the sunroof is not reset after the vehicle battery is disconnected or discharged, or the sunroof fuse is blown, the sunroof may not operate normally.

Sunroof open warning

Sedan

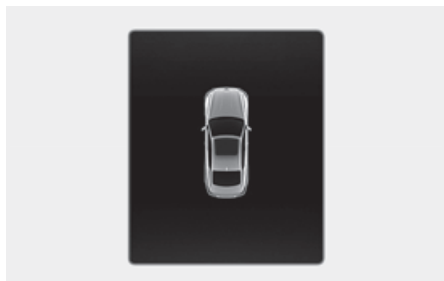

Shooting Brake

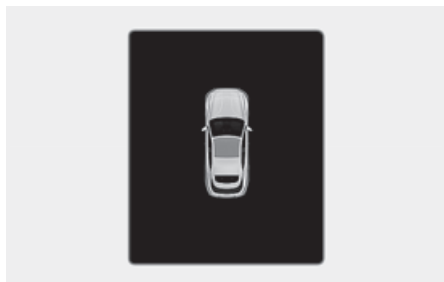

If the driver turns off the engine when the sunroof is not fully closed, the warning chime will sound for several seconds and the sunroof open warning will appear on the cluster display.

Close the sunroof securely when leaving your vehicle.

NOTICE

Do not leave sunroof open when leaving the vehicle to prevent theft or damage from water entering the vehicle.

Hood

Opening the hood

1. Park the vehicle and set the parking brake.
2. Pull the release lever to unlatch the hood. The hood should pop open slightly.



3. Go to the front of the vehicle, raise the hood slightly, push up the secondary latch (1) inside of the hood center and lift the hood (2).

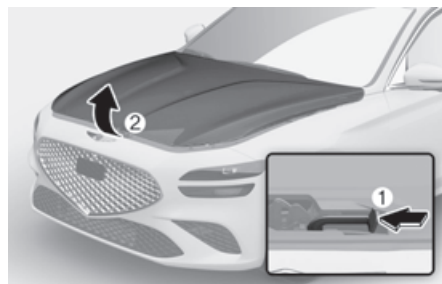

After the hood has been lifted halfway, it will raise completely by itself.

Closing the hood

1. Before closing the hood, check in and around the engine compartment to ensure the following:
 - Any tools or other loose objects are removed from the engine room area or hood opening area
 - All glove, rags, or other combustible material is removed from the engine compartment
 - All filler caps are tightly and correctly installed
2. Lower the hood halfway (lifted about 30 cm (12 in.) from the closed position) and push down to securely lock in place. Then double check to be sure the hood is secure. If the hood can be raised slightly, it is not securely locked. Open it again and close it with more force.

WARNING

- Before closing the hood, ensure all obstructions are removed from around the hood opening.
- Always double check to be sure that the hood is firmly latched before driving away. Check there is no hood open warning light or message displayed on the instrument cluster. Driving with the hood opened may cause a total loss of visibility, which might result in an accident.
- Do not move the vehicle with the hood in the raised position, as vision is obstructed, which might result in an accident, and the hood could fall or be damaged.

Non-Powered Trunk

 if equipped

Opening the trunk

1. Make sure the vehicle is shifted to P (Park) and engage the parking brake.
2. Then do one of the following :
 - Press the smart key trunk open button for more than one second.
 - Press the button (1) on the trunk itself with the smart key in your possession.

Outside



- Use the trunk release button.

Inside



3. Lift the trunk lid up.

Closing the trunk

Lower the trunk lid and press down until it locks. To be sure the trunk lid is securely fastened, always check by trying to pull it up again.

WARNING

Always keep the trunk lid completely closed while the vehicle is in motion. If it is left open or ajar, poisonous exhaust gases containing carbon monoxide (CO) may enter the vehicle and serious illness or death may result.

i Information

To prevent damage to the trunk lift cylinders and the attached hardware, always close the trunk before driving.

NOTICE

In cold and wet climates, trunk lock and trunk mechanisms may not work properly due to freezing conditions.

WARNING

Your vehicle should be kept locked and keys should be kept out of the reach of children. Parents should teach their children about the dangers of playing in the trunk.

Emergency trunk safety release

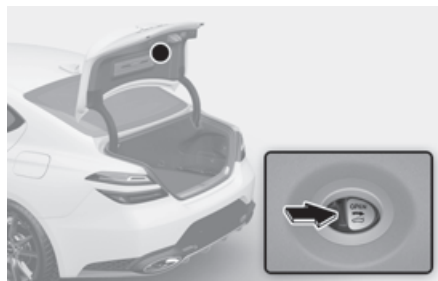

Your vehicle is equipped with an Emergency Trunk Safety Release lever located inside the vehicle. When someone is inadvertently locked in the trunk, the trunk can be opened by moving the lever in the direction of the arrow and pushing the trunk open.

WARNING

- You and your passengers must be aware of the location of the Emergency Trunk Safety Release lever in this vehicle and how to open the trunk in case you are accidentally locked in the trunk.
- Never allow anyone to occupy the trunk of the vehicle at any time. If the trunk is partially or totally latched and the person is unable to get out, serious injury or death could occur due to lack of ventilation, exhaust fumes and rapid heat build-up, or because of exposure to cold weather conditions. The trunk is also a highly dangerous location in the event of a crash because it is not a protected occupant space but is a part of the vehicle's crush zone.
- Your vehicle should be kept locked and the smart key should be kept out of the reach of children. Parents should teach their children about the dangers of playing in trunks.
- Use the release lever for emergencies only.

Trunk release lever

When the vehicle battery is discharged or the trunk needs to be opened manually

1. Fold the rear seats using the seatback folding lever (1).



2. Open the trunk using the Emergency Trunk Safety Release lever.

WARNING

Make sure to at least have minimum space at the back and in the upper area of the trunk when opening or closing the trunk. If not, the trunk may hit the surrounding objects (wall, ceiling, vehicle, etc.) and result in damaging the vehicle or injuring the person near.

Power trunk

 if equipped

Power trunk operating conditions

The power trunk operates when vehicle speed is below 3 km/h (1.8 mph).

WARNING

- Never leave children or animals unattended in your vehicle. Children may operate the power trunk. Doing so can result in injury to themselves or others and can damage the vehicle.
- Make sure there are no people or objects and enough space around the trunk before operating the power trunk or smart trunk prior to use. Serious injury, damage to the vehicle or damage to surrounding objects (for example, walls, ceilings, vehicles, etc.) may result if contact with the trunk occurs.
- Make sure there are no people or objects around the trunk before operating the power trunk. Wait until the trunk is opened fully and stopped before loading or unloading cargo from the vehicle.
- Always keep the trunk lid completely closed while the vehicle is in motion. If it is left open or ajar, poisonous exhaust gases containing carbon monoxide (CO) may enter the vehicle and serious illness or death may result.

NOTICE

- Do not close or open the power trunk manually. This may cause damage to the power trunk. If it is necessary to close or open the power trunk manually when the battery is discharged or disconnected, do not apply excessive force.
 - Do not operate the power trunk more than 10 times continuously when the engine is not running. Use the power trunk with the engine running when the power trunk is used repeatedly to prevent battery discharge.
 - Do not leave the trunk open for a long period of time. This may drain the battery.
 - Do not modify or repair any part of the power trunk by yourself. This must be done by an authorized retailer of Genesis Branded products.
 - Do not operate the power trunk under the following conditions. The power trunk may not operate properly.
 - One side of the vehicle is lifted to inspect the vehicle or change a tire
 - Parking on an uneven road such as a slope, etc.
 - Close the trunk completely and lock all doors and trunk using the central door lock button before using an automatic car wash.
 - Do not spray high pressure water directly on the power trunk outside open/close button. The trunk may open unintentionally.
-

***i* Information**

- In cold and wet climates, the outside power trunk open button may not work properly due to freezing conditions. If this occurs, remove the ice before using the outside power trunk open button or use the power trunk open button on the smart key or the instrument panel.
 - If you leave the smart key in the trunk and close the trunk, a warning will sound for about 5 seconds. If this occurs, open the trunk by pressing the power trunk open button on the outside of the trunk.
 - If there are obstacles such as snow on the trunk, the trunk may not open automatically. After removing the obstacle, try to open it again.
 - Be careful where there is an incline, as the trunk lid may drop slightly when it is stopped before it fully opens.
-

Operating the power trunk

Power trunk open (Smart key)



When the trunk is closed, press the power trunk open button for 1 second. The trunk will open with a warning sound.

While the trunk is opening, press the button to stop power trunk operation.

Power trunk open/close button (Instrument panel)



When the trunk is closed, press the power trunk open/close button for 1 second. The power trunk will open with a warning sound.

While the trunk is opening, press the button to stop power trunk operation.

When the trunk is opened, press and hold the trunk open/close button to close the power trunk. If you release the button while the trunk is closing, power trunk operation will stop with a warning sound for 5 seconds.

Power trunk open button (Outside the power trunk)



When the trunk is closed, press the power trunk open button to open the trunk.

If the vehicle is locked, press the power trunk open button with the smart key in your possession.

While the trunk is opening, press the button to stop power trunk operation.

Power trunk close button (Inside the power trunk)



Press the power trunk close button. The trunk will close with a warning sound.

While the trunk is closing, press the button to stop power trunk operation.

Power trunk lock button (Inside the power trunk)



Press the power trunk lock button while carrying the smart key. The power trunk will close and lock with a warning sound. Additionally, all doors will lock.

The trunk will close and lock, and all doors will lock only when the engine is off.

Switching the power trunk from manual to automatic

If you apply over a certain amount of power manually when the trunk is opened, the power trunk system detects the direction and closes or opens automatically.

- The power trunk fully opens when the trunk is raised
- The power trunk closes completely when the trunk is lowered

***i* Information**

The power trunk may not operate properly if the trunk is not opened above a certain height.

Automatic reverse

During power trunk operation if the power trunk senses any obstacle, the trunk will stop or will fully open. The automatic reverse feature may not operate properly, or it may operate unexpectedly under the following circumstances:

- The automatic reverse feature may not detect the resistance if the detected resistance is below a certain level, or if the trunk is almost fully closed near the latched position.
- The automatic reverse feature may operate if a strong impact is applied with no obstructions placed.

⚠ WARNING

Never intentionally place any object or part of your body in the path of the power trunk to make sure the automatic reverse feature operates. Serious injury, or damage to the vehicle or object may occur.

***i* Information**

The power trunk may stop operating if the automatic reverse feature operates more than two times while attempting to open or close the trunk. If this occurs, carefully open or close the trunk manually, and then after 30 seconds try to operate the power trunk automatically again.

Setting the power trunk

Power trunk opening height

To adjust the power trunk opening height, select **Setup (Settings) > Vehicle > Door > Power Trunk opening height** in the infotainment system.

i Information

The infotainment system may change after software updates. For more information, refer to the manual provided in the infotainment system and the quick reference guide.

Resetting the power trunk

In some circumstances resetting the power trunk operation may need to be performed. Some instances where resetting the power trunk may be required include:

- When the 12 V battery is recharged
- When the 12 V battery is reinstalled after removal or replacement
- When the related fuse is reinstalled after removal or replacement
 1. With the engine off or running, put the gear in P (Park).
 2. While Pressing the power trunk close inner button, press the power trunk open outer button for more than 3 seconds. A chime will sound.
 3. Slowly close the trunk manually.
 4. Press the power trunk open outer button. The trunk will open with a chime sound.

Wait until the trunk fully opens to complete resetting. If the trunk stops before it is fully open, resetting cannot be completed.

i Information

If the power trunk does not operate properly after the above procedure, we recommend that the system be inspected by an authorized retailer of Genesis Branded products.

Emergency trunk safety release

- **Inside the trunk**



Your vehicle is equipped with an emergency trunk safety release lever located inside the trunk. When someone is inadvertently locked in the trunk, the trunk can be opened by moving the lever in the direction of the arrow and pushing the trunk lid to open.

• Inside the vehicle

Follow the below procedure to open the trunk manually when the battery is discharged or when there is a problem with the vehicle:

1. Fold the rear seats using the seatback folding lever (1).



2. Open the trunk using the Emergency Trunk Safety Release lever.

⚠ WARNING

- You and your passengers must be aware of the location of the Emergency Trunk Safety Release lever in this vehicle and how to open the trunk in case you are accidentally locked in the trunk.
- Never allow anyone to occupy the trunk of the vehicle at any time.
- Use the release lever for emergencies only.

Power tailgate

+ if equipped

Power tailgate operating conditions

The power tailgate operates when the gear is in P (Park) with the engine running. However, the power tailgate will operate regardless of the gear position when the engine is off. Also, the tailgate can be opened only when vehicle speed is below 3 km/h (1.8 mph).

For safety, before attempting to open or close the tailgate, make sure the vehicle is in P (Park).

⚠ WARNING

- Never leave children or animals unattended in your vehicle. Children may operate the power tailgate. Doing so can result in injury to themselves or others and can damage the vehicle.
- Make sure that there are no people or objects in the path of the power tailgate or smart tailgate prior to use. Serious injury, damage to the vehicle or damage to surrounding objects (for example, walls, ceilings, vehicles, etc.) may result if contact with the tailgate occurs.

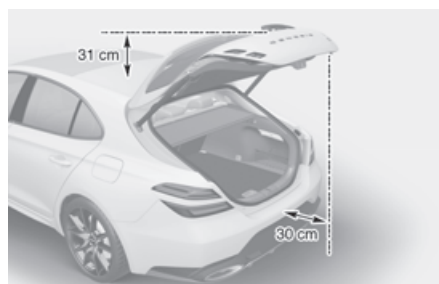

- The tailgate may not open or may close unintentionally injuring people around the tailgate under the following situation:
 - There is a lot of snow on the tailgate.
 - There is a heavy object on the tailgate such as a bicycle carrier, ladder, etc.

Do not open the tailgate before removing snow or heavy object on the tailgate.

NOTICE

- Do not close or open the tailgate manually. This may cause damage to the power tailgate. If it is necessary to close or open the tailgate manually when the battery is discharged or disconnected, do not apply excessive force.
 - Do not operate the power tailgate more than 10 times continuously when the engine is not running. Use the power tailgate with the engine running when the power tailgate is used repeatedly to prevent battery discharge.
 - Do not leave the power tailgate open for a long period of time. This may drain the battery.
 - Do not apply excessive force when the power tailgate is operating. Doing so could result in vehicle damage.
 - Do not grab or hold on to the tailgate support struts at any time. Damage to the tailgate support struts could result. Deformation of the tailgate support struts may cause vehicle damage and personal injury may occur.
- Do not modify or repair any part of the power tailgate by yourself. This must be done by an authorized retailer of Genesis Branded Products.
 - Do not operate the power tailgate under the following conditions. The power tailgate may not operate properly.
 - One side of the vehicle is lifted to inspect the vehicle or change a tire.
 - Parking on an uneven road such as a slope, etc.
 - Close the tailgate completely and lock all doors and tailgate using the central door lock button before using an automatic car wash.
 - Do not spray high pressure water directly on the power tailgate outside open/close button. The tailgate may open unintentionally.
-



i Information

- If the tailgate is not fully closed and vehicle speed is at or above 3 km/h (1.8 mph), a warning will sound 10 times. Immediately park the vehicle at a safe place, close the tailgate, and check that the tailgate open warning on the instrument cluster is turned off.
- In cold and wet climates, the outside power tailgate open/close button may not work properly due to freezing conditions. If this occurs, remove the ice before using the outside power tailgate open/close button or use the power tailgate open/close button on the smart key or the instrument panel.
- Operating the power tailgate more than 5 times continuously could cause damage to the operating motor. If this occurs, the power tailgate will not operate to prevent the motor from overheating. If any of the power tailgate buttons are pressed to try to open the tailgate, the chime will sound 3 times, but the tailgate will remain closed. Allow the power tailgate system to cool for about 1 minute before operating the system again.

Operating the power tailgate

Power tailgate open/close button (Smart key)



Power tailgate open/close button (Instrument panel)



Press the power tailgate open/close button for 1 second. The tailgate opens or closes with a warning sound.

While the tailgate is opening or closing, press the button to stop tailgate operation.

If the smart key is not within operation range (about 10 m) from the vehicle, tailgate operation will stop with a warning sound for 5 seconds.

Power tailgate open button (Outside the power tailgate)



When the tailgate is closed, press the power tailgate open/close button to open the tailgate.

If the vehicle is locked, press the power tailgate open/close button with the smart key in your possession.

If the tailgate is unlocked, the tailgate will open or close with a warning sound when the power tailgate open/close button is pressed without carrying the smart key.

Power tailgate close button (Inside the power tailgate)



Press the power tailgate open/close button. The tailgate opens or closes automatically.

Power tailgate lock button (Inside the power tailgate)



Press the power tailgate lock button whilst carrying the smart key. The tailgate closes and locks automatically. Additionally, all doors will lock.

The tailgate can be closed and locked, and all doors locked only when the button is pressed whilst the engine is off.

Automatic reverse

During power tailgate operation if the power tailgate senses any obstacle, the tailgate will stop or will fully open. The automatic reverse feature may not operate properly, or it may operate unexpectedly under the following circumstances:

- The automatic reverse feature may not detect the resistance if the detected resistance is below a certain level, or if the tailgate is almost fully closed near the latched position.
- The automatic reverse feature may operate if a strong impact is applied with no obstructions placed.

WARNING

Never intentionally place any object or part of your body in the path of the power tailgate to make sure the automatic reverse feature operates. Serious injury, or damage to the vehicle or object may occur.

Information

The power tailgate may stop operating if the automatic reverse feature operates more than two times whilst attempting to open or close the tailgate. If this occurs, carefully open or close the tailgate manually, and then after 30 seconds try to operate the power tailgate automatically again.

Power tailgate settings

Power tailgate opening speed

To adjust the power tailgate opening speed, select **Setup (Settings) > Vehicle > Door > Power Tailgate speed** in the infotainment system.

Power tailgate opening height

To adjust the power tailgate opening height, select **Setup (Settings) > Vehicle > Door > Power Tailgate opening height** in the infotainment system.

Information

The infotainment system may change after software updates. For more information, refer to the manual provided in the infotainment system and the quick reference guide.

User height setting

1. Position the tailgate manually to the height you prefer.
2. Press the power tailgate open/close button located inside the tailgate for more than 3 seconds.

If **User Height Setting** is selected for the power tailgate opening height, the power tailgate will automatically open to the height manually set by you.

i Information

- If the power tailgate opening height has not been manually set, the power tailgate will fully open when **User Height Setting** from the infotainment system is selected.
- If one of the height setting (**Full Open/Level 3/Level 2/Level 1**) is selected from the settings menu in the infotainment system, and then **User Height Setting** is selected, the tailgate will open to the height manually set by you.
- The power tailgate opening speed and opening height settings change according to the linked User Profile. If the User Profile is changed, power tailgate opening speed and opening height settings will change accordingly.

Resetting the power tailgate

In some circumstances resetting the power tailgate operation may need to be performed. Some instances where resetting the power tailgate may be required include:

- When the 12 V battery is recharged
- When the 12 V battery is reinstalled after removal or replacement
- When the related fuse is reinstalled after removal or replacement

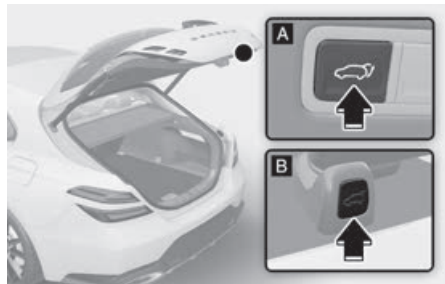

1. With the engine off or running, put the gear in P (Park).
2. Press the power tailgate open/close inner button (A) and outer button (B) simultaneously until a chime sounds.
3. Slowly close the tailgate manually.
4. Press the power tailgate open/close outer button (B). The power tailgate will open with a chime sound. Wait until the tailgate fully opens to complete resetting. If the tailgate stops before it is fully open, resetting cannot be completed.

i Information

If the power tailgate does not operate properly after the above procedure, we recommend that the system be inspected by an authorized retailer of Genesis Branded products.

Emergency tailgate safety release

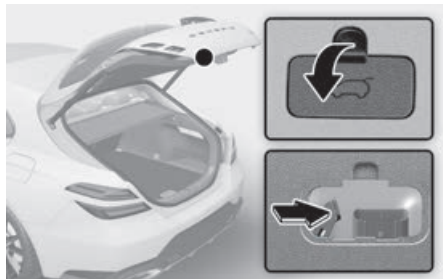

To unlock and open the tailgate manually from inside the luggage compartment, perform the following procedure:

1. Remove the cover at the bottom of the tailgate.
2. Slide the latch in the direction of the arrow to unlock the tailgate.
3. Push the tailgate to open.

WARNING

- For emergencies, be fully aware of the location of the emergency tailgate safety release latch in the vehicle and how to open the tailgate if you are accidentally locked in the luggage compartment.
- No one, including animals, should be allowed to occupy the luggage compartment of the vehicle at any time. The luggage compartment is a very dangerous location in the event of an accident.
- Use the release latch for emergencies only. Use extreme caution, especially whilst the vehicle is in motion.

Smart trunk (or tailgate)

Sedan

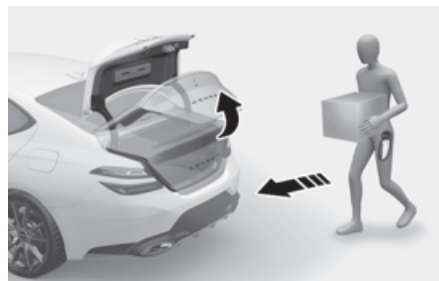

Shooting Brake



On a vehicle equipped with a smart key, the trunk (or tailgate) can be opened with hands-free activation using the smart trunk (or tailgate) system.

How to use the smart trunk (or tailgate)

The hands-free smart trunk (or tailgate) system can be opened automatically when the following conditions are met:

- The smart trunk (or tailgate) option is enabled from the Settings menu in the infotainment system.
- The smart trunk (or tailgate) is activated and ready 15 seconds after all the doors are closed and locked
- The smart trunk (or tailgate) will open when the smart key is detected in the area behind the vehicle for 3 seconds

i Information

The smart trunk (or tailgate) will NOT operate when:

- Any door is open, or all doors are closed but not locked
 - The smart key is detected within 15 seconds from when the doors were closed and locked
 - For vehicles equipped with illuminated exterior front door handles, if the smart key is detected within 15 seconds from when the doors were closed and locked or if the smart key is within 1.5 m (60 in.) from the front door handles
 - The smart key is in the vehicle.
-

1. Settings

To use smart trunk (or tailgate), it must be enabled from the Settings menu in the infotainment system. Select:

- **Setup (Settings) > Vehicle > Door (or Tailgate) > Smart Trunk/Smart Tailgate**

i Information

The infotainment system may change after software updates. For more information, refer to the manual provided in the infotainment system and the quick reference guide.

2. Detect and Alert

The smart trunk (or tailgate) detecting area extends about 50-100 cm (20-40 in.) behind the vehicle. If you are positioned in the detecting area and are carrying the smart key, the hazard warning lights will blink and the chime will sound to alert you that the smart trunk (or tailgate) will open.

i Information

Do not approach the detecting area if you do not want the trunk (or tailgate) to open. If you have unintentionally entered the detecting area and the hazard warning lights and chime starts to operate, move away from the area behind the vehicle with the smart key. The trunk (or tailgate) will remain closed.

3. Automatic opening

After the hazard warning lights blink and the chime sounds 6 times, the smart trunk (or tailgate) will open.

Deactivating smart trunk (or tailgate)



- (1) Door lock
- (2) Door unlock
- (3) Trunk open (or tailgate open/close)

If you press any button on the smart key during the Detect and Alert stage, the smart trunk (or tailgate) function will be deactivated.

Make sure to be aware of how to deactivate the smart trunk (or tailgate) function for emergency situations.

i Information

- If you press the door unlock button (2), the smart trunk (or tailgate) function will be deactivated temporarily. But, if you do not open any door for 30 seconds, the smart trunk (or tailgate) function will be activated again.
- If you press the trunk (or tailgate) open button (3) for more than 1 second, the trunk (or tailgate) opens.
- The smart trunk (or tailgate) function will still be activated if you press the door lock button (1) or trunk (or tailgate) open button (3) on the smart key as long as the smart trunk (or tailgate) is not already in the Detect and Alert stage.
- In case you have deactivated the smart trunk (or tailgate) function by pressing the smart key button and opened a door, the smart trunk (or tailgate) function can be activated again by closing and locking all doors.

Detecting area

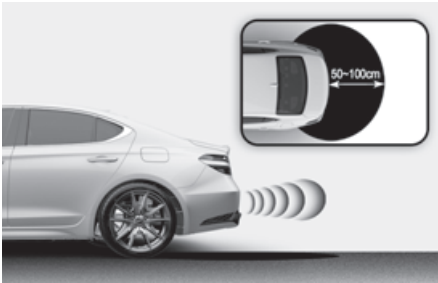

- The smart trunk (or tailgate) detecting area extends about 50-100 cm (20-40 in.) behind the vehicle. If you are positioned in the detecting area and are carrying the smart key, the hazard warning lights will blink and the chime will sound for about 3 seconds to alert you that the smart trunk (or tailgate) will open.
- The alert stops once the smart key is moved outside of the detecting area within the 3 second period.

i Information

- Smart trunk (or tailgate) may not operate properly if any of the following occur:
 - The smart key is close to a radio transmitter such as a radio station or an airport which can interfere with normal operation of the transmitter.
 - The smart key is near a mobile two way radio system or a mobile phone.
 - Another vehicle's smart key is being operated close to your vehicle.
 - The temperature drops below freezing.
- The smart trunk (or tailgate) detecting area may change when:
 - The vehicle is parked on an incline or slope.
 - One side of the vehicle is raised or lowered relative to the opposite side.

Fuel filler door

Opening the fuel filler door

1. Turn the engine off.
2. Push the fuel filler door open button.



3. Pull the fuel filler door (1) outward to access the fuel tank cap.
4. To remove the fuel tank cap (2), turn it counterclockwise. You may hear a hissing noise as the pressure inside the tank equalizes.

Gasoline

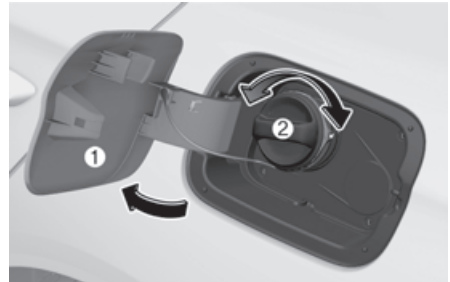

Diesel

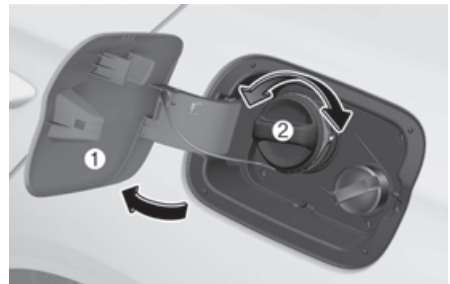

5. Place the cap on the fuel filler door.

i Information

For information on urea solution for diesel engine vehicles, refer to the “Selective Catalytic Reduction (SCR) (for diesel engine)” section in chapter 9.

i Information

If the fuel filler door does not open because ice has formed around it, tap lightly or push on the door to break the ice and release the door. Do not pry on the door. If necessary, spray around the door with an approved deicer fluid (do not use radiator antifreeze) or move the vehicle to a warm place and allow the ice to melt.

Closing the fuel filler door

1. To install the fuel tank cap, turn it clockwise until it “clicks” one time.
2. Close the fuel filler door until it is latched securely.

i Information

The fuel filler door will not close if the driver’s door is locked. If you lock the driver’s door while fueling, unlock it before closing the fuel filler door.

WARNING

Automotive fuel is highly flammable and explosive. Failure to follow these guidelines may result in **SERIOUS INJURY** or **DEATH**:

- Read and follow all warnings posted at the gas station.
- Before refueling, note the location of the Emergency Fuel Shut-Off, if available, at the gas station.
- Before touching the fuel nozzle, you should eliminate the potential build-up of static electricity by touching a metal part of the vehicle, a safe distance away from the fuel filler neck, nozzle, or other gas source, with your bare hand.
- Do not use mobile phones while refueling. Electric current and/or electronic interference from cellular phones can potentially ignite fuel vapors and cause a fire.
- Do not get back into a vehicle once you have begun refueling. You can generate a buildup of static electricity by touching, rubbing or sliding against any item or fabric capable of producing static electricity. Static electricity discharge can ignite fuel vapors causing a fire. If you must re-enter the vehicle, you should once again eliminate potentially dangerous static electricity discharge by touching a metal part of the vehicle, away from the fuel filler neck, nozzle or other fuel source, with your bare hand.

- When using an approved portable fuel container, be sure to place the container on the ground prior to refueling. Static electricity discharge from the container can ignite fuel vapors causing a fire.

Once refueling has begun, contact between your bare hand and the vehicle should be maintained until the filling is complete.

- Use only approved portable plastic fuel containers designed to carry and store fuel.
- When refueling, always shift the gear to the P (Park) position, set the parking brake, and press the Engine Start/Stop button to the OFF position. Sparks produced by electrical components related to the engine can ignite fuel vapors causing a fire.
- Do not use matches or a lighter and do not smoke or leave a lit cigarette in your vehicle while at a gas station, especially during refueling.
- Do not over-fill or top-off your vehicle tank, which can cause fuel spillage.
- If a fire breaks out during refueling, leave the vicinity of the vehicle, and immediately contact the manager of the gas station and then contact the local fire department. Follow any safety instructions they provide.
- If pressurized fuel sprays out, it can cover your clothes or skin and thus subject you to the risk of fire and burns. Always remove the fuel cap carefully and slowly. If the cap is venting fuel or if you hear a hissing sound, wait until the condition stops before completely removing the cap.
- Always check that the fuel cap is installed securely to prevent fuel spillage in the event of an accident.

i Information

Make sure to refuel your vehicle according to the “Fuel requirements” section in chapter 1.

NOTICE

- Do not spill fuel on the exterior surfaces of the vehicle. Any type of fuel spilled on painted surfaces may damage the paint.
- If the fuel filler cap requires replacement, we recommend that you only use a genuine Genesis cap or the equivalent (of the genuine part) specified for your vehicle. An incorrect fuel filler cap can result in a serious malfunction of the fuel system or emission control system.

Emergency fuel filler lid release

If the fuel filler lid does not open using the remote fuel filler lid release, you can open it manually by pulling the handle outward slightly.

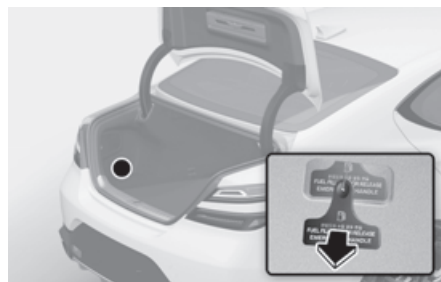

NOTICE

Do not pull the handle excessively, otherwise the luggage area trim or release handle may be damaged.

Head-UP display (HUD)

 if equipped

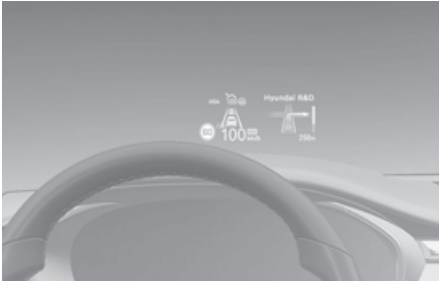

The Head-Up Display is an optional feature that allows the driver to view information projected onto a transparent screen while still keeping your eyes safely on the road ahead while driving.

Head-UP display settings

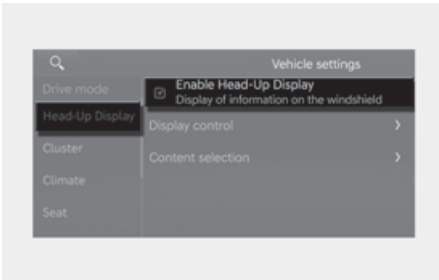

- Head-UP display can be enabled from the Settings menu in the infotainment system. Select:
 - **Setup (Settings) > Vehicle > Head-UP Display > Enable Head-UP Display**
- After turning on the Head-UP display, you can change the settings of **Display Control** and **Content Selection** of the Head-UP display.

i Information

The infotainment system may change after software updates. For more information, refer to the manual provided in the infotainment system and the quick reference guide.

Head-UP display information

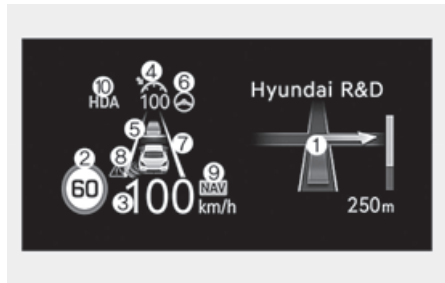

- (1) Turn by Turn (TBT) navigation information
- (2) Traffic signs or speed limit
- (3) Speedometer
- (4) SCC set speed
- (5) SCC Vehicle distance
- (6) Lane Following Assist
- (7) Lane Safety
- (8) Blind-Spot Safety
- (9) Highway Auto Speed Change
- (10) Highway Driving Assist

Precautions while using the Head-UP display

- It may sometimes be difficult to read information on the Head-UP display in the following situations.
 - The driver is improperly positioned in the driver's seat.
 - The driver wears polarizing-filter sunglasses.
 - An object is located above the Head-UP display cover
 - The vehicle is driven on a wet road.
 - Any improper lighting accessory is installed inside the vehicle, or there is incoming light from outside of the vehicle.
 - The driver wears glasses.
 - The driver wears contact lenses.

When it is difficult to read the Head-UP display information, adjust the image height or brightness level from the Settings menu in the infotainment system.

i Information

The infotainment system may change after software updates. For more information, refer to the manual provided in the infotainment system and the quick reference guide.

- For your safety, make sure to stop the vehicle before adjusting the settings.
- Do not tint the front windshield glass or add other types of metallic coating. Otherwise, the Head-UP display image may be invisible.
- Do not place any accessories on the crash pad or attach any objects on the windshield glass.

- When replacing the front windshield glass, replace it with a windshield glass designed for Head-UP display operation. Otherwise, duplicated images may appear on the windshield glass.

WARNING

The warning information of Blind-Spot Safety on the Head-UP display are supplemental. Do not solely depend on them to change lanes. Always take a look around before changing lanes.

i Information

Head-UP Display includes GPL, LGPL, MPL and other open source license softwares. All license notices including related source code are provided at <http://www.mobis.co.kr/opensource/list.do>.

If the driver requests on-board software open source code via MOBIS_OSSrequest@mobis.co.kr within 3 years after buying this product, a CD-ROM or other storage device will be sent with the minimum cost covering storage device cost and delivery cost.

Exterior lights

Lighting control

To operate the lights, turn the knob at the end of the control lever to one of the following positions:

Type A

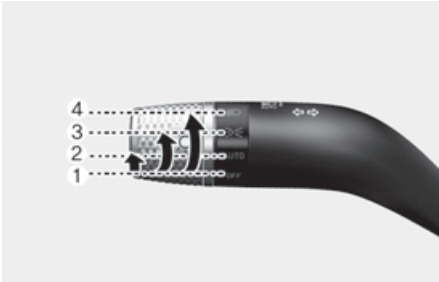

Type B

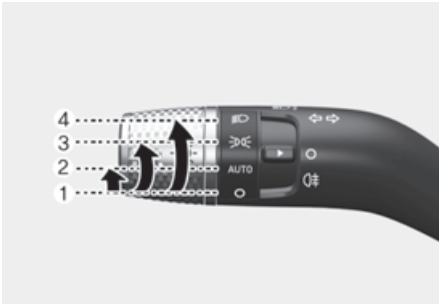

Type C

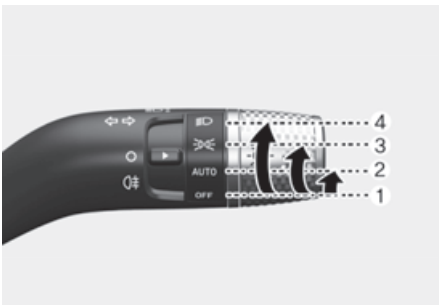

- (1) OFF (O)
- (2) AUTO headlight
- (3) Position light
- (4) Headlight

AUTO headlight

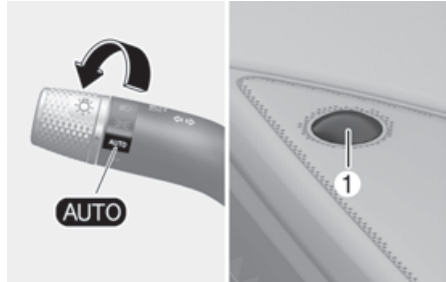

The position light and headlight will be turned ON or OFF automatically depending on the amount of daylight as measured by the ambient light sensor (1) at the upper end of the windshield glass.

Even with the AUTO headlight feature in operation, it is recommended to manually turn ON the headlights when driving at night or in a fog, driving in the rain, or when you enter dark areas, such as tunnels and parking facilities.

NOTICE

- Do not cover or spill anything on the sensor (1) located at the upper end of the windshield glass.
- Do not clean the sensor using a window cleaner, the cleanser may leave a light film which could interfere with sensor operation.
- If your vehicle has window tint or other types of metallic coating on the front windshield, the AUTO headlight system may not work properly.

Position light (☞)



The position light, license plate lamp and instrument panel lamp are turned ON.

Headlight (☞)



The headlight, position light, license plate lamp and instrument panel lamp are turned ON.

i Information

The Engine Start/Stop button must be in the ON position to turn on the headlight.

High beam operation



To turn on the high beam headlight, push the lever away from you. The lever will return to its original position.

The high beam indicator will light when the headlight high beams are switched on.

To turn off the high beam headlight, pull the lever towards you. The low beams will turn on.

! WARNING

Do not use high beam when there are other vehicles approaching you. Using high beam could obstruct the other driver's vision.



To flash the high beam headlight, pull the lever towards you, then release the lever. The high beams will remain ON as long as you hold the lever towards you.

Turn signals and lane change signals

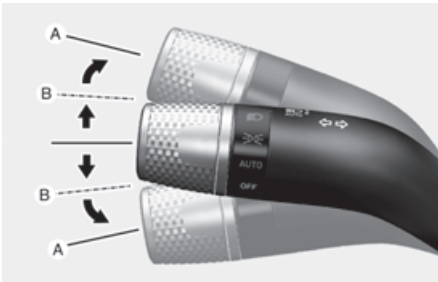

To signal a turn, push down on the lever for a left turn or up for a right turn in position (A).

If an indicator stays on and does not flash or if it flashes abnormally, one of the turn signal bulbs may be burned out and will require replacement.

One touch turn signal

To use One Touch Turn Signal push the turn signal lever up or down to position (B) and then release it.

The lane change signals will blink 3, 5 or 7 times.

You can enable the One Touch Turn Signal function or choose the number of blinking by selecting **Setup (Settings) > Vehicle > Light > One-touch turn indicator > 3 flashes/5 flashes/7 flashes/Off** in the infotainment system.

i Information

The infotainment system may change after software updates. For more information, refer to the manual provided in the infotainment system and the quick reference guide.

Rear fog light

 If equipped



To turn on the rear fog light:

Position the headlight switch in the headlight position, and then turn the headlight switch (1) to the rear fog light position.

To turn the rear fog lights off, do one of the following:

- Turn off the headlight switch.
- Turn the headlight switch (1) to the rear fog lamp position again.

Battery saver function

To prevent the battery from being discharging, the system automatically turns off the position light when the driver turns the vehicle off and opens the driver's door.

With this feature, the position lights turn off automatically if the driver parks on the side of road at night.

To keep the lights on when the vehicle is turned off:

1. Open the driver's door.
2. Turn the position lights OFF and ON again using the headlight switch.

Headlight delay function

 if equipped

If the Engine Start/Stop button is in the ACC position or the OFF position with the headlights ON, the headlights (and/or position lights) remain on for about 5 minutes. However, if the driver's door is opened and closed, the headlights are turned off after 15 seconds. Also, with the vehicle off if the driver's door is opened and closed, the headlights (and/or position lights) are turned off after 15 seconds.

The headlights (and/or position lights) can be turned off by pressing the lock button on the smart key twice or turning the headlight switch to the OFF or AUTO position.

You can enable the headlight delay function by selecting **Setup (Settings) > Vehicle > Light > Headlight Delay (Headlight time-out)** in the infotainment system.

Information

The infotainment system may change after software updates. For more information, refer to the manual provided in the infotainment system and the quick reference guide.

NOTICE

If the driver exits the vehicle through another door besides the driver door, the battery saver function does not operate and the headlight delay function does not turn OFF automatically.

This may cause the battery to discharge. To avoid battery discharge, turn OFF the headlights manually from the headlamp switch before exiting the vehicle.

Daytime Running Light (DRL)

The Daytime Running Lights (DRL) can make it easier for others to see the front of your vehicle during the day, especially after dawn and before sunset. It automatically turns ON once the engine is started.

The DRL system will turn the dedicated light OFF when :

- The headlights are ON.
- The parking brake is applied.
- The engine is OFF

Headlight leveling device

 if equipped

Headlight leveling device automatically adjusts the headlight beam level according to the number of passengers and loading weight in the luggage area.

It also adjusts to the appropriate headlight beam level for various situations.

WARNING

If the function does not work properly, we recommend that the system be inspected by an authorized retailer of Genesis Branded products. Do not attempt to inspect or replace the wiring yourself.

Reverse guide light

When the gear is in R (Reverse), the back-up light turns on and the reverse guide light at the back of the vehicle lights the floor.

The light informs nearby drivers that your vehicle is backing up.

Headlight moisture removal function

When moisture fogs up inside of the headlight, if the headlight is on for certain period of time, the fan circulates the air inside to remove moisture. If moisture is not removed, we recommend that you have the vehicle inspected by an authorized retailer of Genesis Branded products.

Welcome system

 If equipped

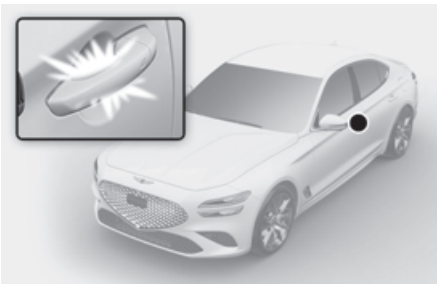

Welcome system helps keep the driver visible by turning on vehicle lights when the driver approaches the vehicle.

Puddle light and door handle light

When all the doors (and trunk (or tailgate)) are closed and locked, the puddle light and door handle light will turn on for about 15 seconds if any of the below is performed.

- When the door unlock button is pressed on the smart key.
- When you put your hand in the outside door handle with the smart key in possession.
- If **Setup (Settings) > Vehicle > Convenience > Welcome mirror/light > On driver approach** is selected from the Settings menu in the infotainment system, the lights will turn on when the vehicle is approached with the smart key in possession.

i Information

The infotainment system may change after software updates. For more information, refer to the manual provided in the infotainment system and the quick reference guide.

Headlight and position light

When the light switch is ON, and all the doors (and trunk (or tailgate)) are closed and locked, the headlight and position light will turn on for about 15 seconds if the door unlock button is pressed on the smart key. Note that if the light switch is in the AUTO position, the headlight and position light will turn on only when it is dark outside.

Select **Setup (Settings) > Light > Headlight time-out** from the Settings menu to turn on this function.

i Information

The infotainment system may change after software updates. For more information, refer to the manual provided in the infotainment system and the quick reference guide.

Interior lamp

When the interior lamp switch is in the  position and all doors (and trunk (or tailgate)) are closed and locked, the room lamp will come on for 30 seconds if any of the below is performed.

- When the door unlock button is pressed on the smart key.
- When you put your hand in the outside door handle while carrying the smart key.

At this time, if you press the door lock or unlock button on the smart key the lamps will turn off immediately.

Puddle light

 if equipped

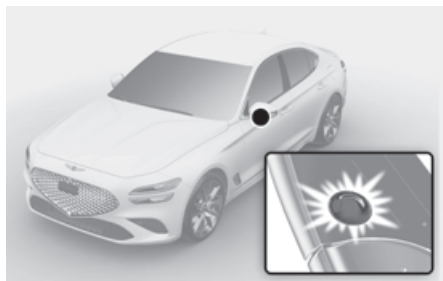

Welcome light

When all doors (and trunk (or tailgate)) are closed and locked, the puddle light will turn on for 15 seconds if the door is unlocked by the smart key or when you put your hand in the outside door handle with the smart key in possession.

For more information, refer to the “Welcome system” in this chapter.

Escort light

When the Engine Start/Stop button is in the OFF position and the driver’s door is opened, the puddle light will turn on for 30 seconds. If the driver’s door is closed within the 30 seconds period, the puddle light will turn off after 15 seconds. If the driver’s door is closed and locked, the puddle light will turn off immediately.

The Puddle Light Escort Light will turn on only the first time the driver’s door is opened after the engine is turned off.

Intelligent Front-Lighting System (IFS)

 if equipped

Intelligent Front-Lighting System secures a clear view for the driver with the high beam on while driving at night.

System setting

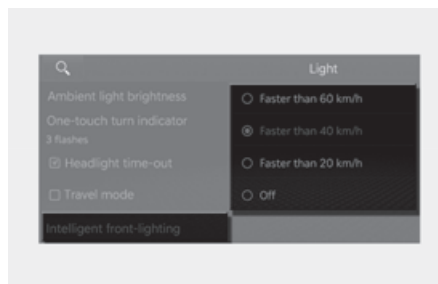

With the Engine Start/Stop button in the ON position, select **Setup (Settings) > Vehicle > Light > Intelligent front-lighting** from the Settings menu to turn on Intelligent Front-Lighting System and deselect to turn off the system.

i Information

The infotainment system may change after software updates. For more information, refer to the manual provided in the infotainment system and the quick reference guide.

WARNING

For your safety, change the Settings after parking the vehicle at a safe location.

i Information

- Travel Mode must be turned on for the headlight on the driver's side to turn off when driving from a left-hand drive country to a right-hand drive country and vice versa.
- To turn on the Travel mode, select **Setup (Settings) > Vehicle > Light > Travel mode** from the infotainment system.

System operation

Display and control

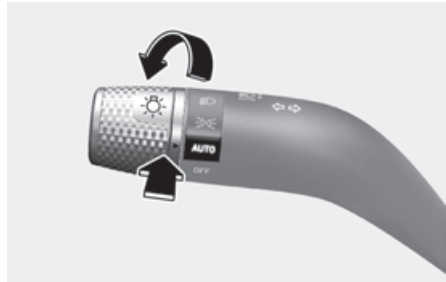

After selecting **Intelligent front-lighting** in the Settings menu, Intelligent Front-Lighting System will operate by following the procedure below.

- Place the headlight switch in the AUTO position and push the head light lever toward the instrument cluster. The

Intelligent Front-Lighting System () indicator light will illuminate on the instrument cluster and the system will be enabled.

- When the system is enabled, the Intelligent Front-Lighting System will operate according to the set speed in the infotainment system. The initial system is set to work when vehicle speed is above 40 km/h (25 mph).
- The high beam LED partially turns off if an oncoming vehicle or a vehicle ahead is detected by the front view camera.
- If Intelligent Front-Lighting System detects an oncoming vehicle or a vehicle ahead while driving at high speed (about above 100 km/h (60 mph), the driver's side headlight will turn off and only the passenger's side headlight will be controlled by the system.

System malfunction and limitations

System malfunction

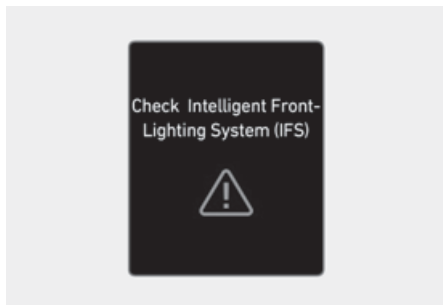

When Intelligent Front-Lighting System is not working properly, the "**Check Intelligent Front-Lighting System (IFS)**" warning message will come on for a few second on the cluster. After the message disappears, the AFS and  will illuminate on the cluster. We recommend that the system be inspected by an authorized retailer of Genesis Branded products.

Type A

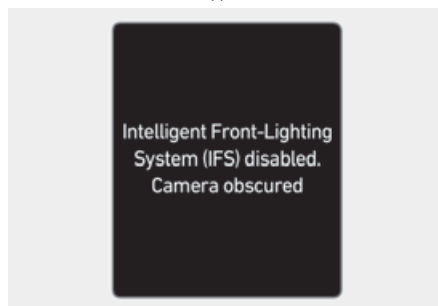

Type B

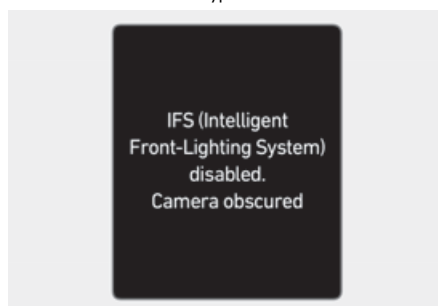

When the front view camera is covered with dirt, snow, or debris, Intelligent Front-Lighting System may temporarily not work properly. If this occurs, a warning message will appear on the instrument cluster.

The system will operate normally when such dirt, snow or debris is removed.

Intelligent Front-Lighting System may not properly operate in an area (for example, open terrain) where any objects or vehicles are not detected after turning on the engine.

Also, even though a warning message does not appear on the instrument cluster, the system may not properly operate.

Limitations of the system

Intelligent Front-Lighting System may not work properly in the following situations:

- Light from a vehicle is not detected because of lamp damage, or because it is hidden from sight, etc.
- Headlight of a vehicle is covered with dust, snow or water.
- A vehicle's headlights are off but the fog lights are on and etc.
- There is a lamp that has a similar shape as a vehicle's lamp.
- Headlights have been damaged or not repaired properly.
- Headlights are not aimed properly.
- Driving on a narrow curved road, rough road, uphill or downhill.
- Vehicle in front is partially visible on a crossroad or curved road.
- There is a traffic light, reflecting sign, flashing sign or mirror ahead.
- There is a temporary reflector or flash ahead (construction area).
- The road conditions are bad such as being wet, iced or covered with snow.

- A vehicle suddenly appears from a curve.
- The vehicle is tilted from a flat tire or is being towed.
- There are many street lights or the ambient light is bright.
- Light from a vehicle is not detected because of exhaust fume, smoke, fog, snow, etc.
- The front windshield is covered with foreign substance.

NOTICE

For more information on the limitations of the front view camera, refer to the "Forward Collision-Avoidance Assist (FCA) (Sensor fusion)" section in chapter 7.

⚠ WARNING

- At times, Intelligent Front-Lighting System may not work properly. The system is for your convenience only. It is the responsibility of the driver for safe driving practices and always check the road conditions for your safety.
 - When the system does not operate normally, switch the headlight position manually between high beam and low beam.
-

High Beam Assist (HBA)

 if equipped

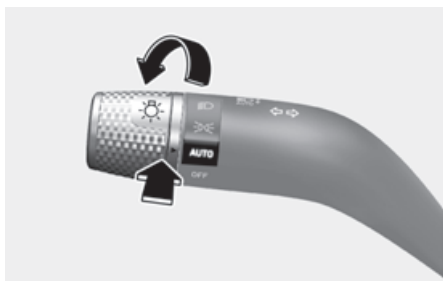

High Beam Assist automatically controls the headlights between high beam and low beam depending on the detected ambient light, such as an oncoming vehicle or leading vehicle.

Detecting sensor



(1) Front view camera

The front view camera is used as a detecting sensor to detect ambient light and brightness while driving.

Refer to the picture above for the detailed location of the detecting sensor.

NOTICE

Always keep the front view camera in good condition to maintain optimal performance of High Beam Assist.

For more information on the precautions of the front view camera, refer to the “Forward Collision-Avoidance Assist (FCA) (Sensor fusion)” section in chapter 7.

High Beam Assist setting

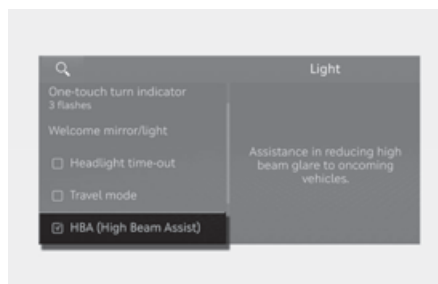

With the Engine Start/Stop button in the ON position, select **Setup (Settings) > Vehicle > Light > High Beam Assist**(or **HBA (High Beam Assist)**) from the Settings menu to turn on High Beam Assist and deselect to turn off the function.

i Information

The infotainment system may change after software updates. For more information, refer to the manual provided in the infotainment system and the quick reference guide.

WARNING

For your safety, change the Settings after parking the vehicle at a safe location.

High Beam Assist operation

Display and control

- After selecting **High Beam Assist** (or **HBA (High Beam Assist)**) in the Settings menu, High Beam Assist will operate by following the procedure below.
 - Place the headlight switch in the AUTO position and push the headlight lever towards the instrument cluster. The High Beam Assist (AUTO) indicator light will illuminate on the cluster and High Beam Assist will be enabled.
 - When High Beam Assist is enabled, high beam will turn on when vehicle speed is above 30 km/h (20 mph). When vehicle speed is below 20 km/h (12 mph), high beam will turn off.
 - The High Beam (H) indicator light will illuminate on the cluster when high beam is on.
- When High Beam Assist is operating, if the headlight lever or switch is used, High Beam Assist operates as follow:
 - If the headlight lever is pulled towards you when the high beam is off, the high beam will turn on without High Beam Assist cancelled. When you let go of the headlight lever, the lever will move to the middle and the high beam will turn off.
 - If the headlight lever is pulled towards you when the high beam is on by High Beam Assist, low beam will turn on and the High Beam Assist will turn off.
 - If the headlight switch is placed from AUTO to another position (headlight/position/off), High Beam Assist will turn off and the corresponding light will turn on.
- When High Beam Assist is operating, high beam switches to low beam if any of the following conditions occur:
 - When the headlight of an oncoming vehicle is detected.
 - When the tail light of a vehicle in front is detected.
 - When the headlight or tail light of a motorcycle or a bicycle is detected.
 - When the surrounding ambient light is bright enough that high beams are not required.
 - When streetlights or other lights are detected.

i Information

The images and colors in the cluster may differ depending on the cluster type or theme selected from the cluster.

High Beam Assist malfunction and limitations

High Beam Assist malfunction

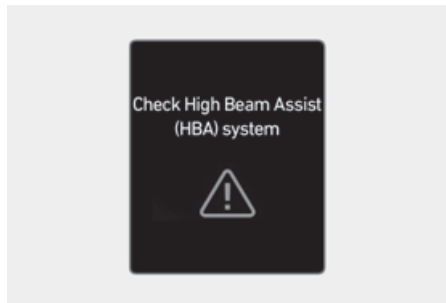

When High Beam Assist is not working properly, the "**Check High Beam Assist (HBA) system**" (or "**Check HBA (High Beam Assist) system**") warning message will appear and  warning light will illuminate on the instrument cluster. We recommend that the vehicle be inspected by an authorized retailer of Genesis Branded products.

Limitations of High Beam Assist

- Light from an oncoming or front vehicle is not detected because of lamp damage, or because it is hidden from sight, etc.
- Headlight of an oncoming or front vehicle is covered with dust, snow or water.
- An oncoming or front vehicle's headlights are off, but the fog lights are on, etc.
- There is a lamp that has a similar shape as a vehicle's lamp.
- Headlights have been damaged or not repaired properly.
- Headlights are not aimed properly.
- Driving on a narrow-curved road, curved road, rough road, uphill or downhill.
- Vehicle in front is partially visible on a crossroad or curved road.
- There is a traffic light, reflecting sign, flashing sign or mirror ahead.
- There is a temporary reflector or flash ahead (construction area).
- The road conditions are bad such as being wet, iced or covered with snow.
- A vehicle suddenly appears from a curve.
- The vehicle is tilted from a flat tire or is being towed.
- Light from an oncoming or front vehicle is not detected due to obstacles in the air such as exhaust fume, smoke, fog, snow, or water spray or blizzard on the road, or fogging in the light, etc.

***i* Information**

For more information on the limitations of the Front View Camera, refer to the "Forward Collision-Avoidance Assist malfunction and limitations" section in chapter 7.

WARNING

- At times, High Beam Assist may not work properly. High Beam Assist is for your convenience only. It is the responsibility of the driver for safe driving practices and always check the road conditions for your safety.
- When High Beam Assist does not operate properly, change the headlight position manually between high beam and low beam.

Interior lights

WARNING

Do not use the interior lights when driving in the dark. The interior lights may obscure your view and cause an accident.

NOTICE

Do not use the interior lights for extended periods when the vehicle is turned off or the battery will discharge.

Interior lamp AUTO cut

The interior lamps will automatically go off about 20 minutes after the vehicle is turned off and the doors are closed. If a door is opened, the lamp will go off 40 minutes after the vehicle is turned off. If the doors are locked by the smart key and the vehicle enters the armed stage of the theft alarm system, the lamps will go off 5 seconds later.

Front lamps



Front map lamp ()

Touch either icons to turn the map lamp on or off. This light produces a spot beam for convenient use as a map lamp at night or as a personal lamp for the driver and the front passenger.

door lamp ()

The front or rear room lamps come on when the front or rear doors are opened. When doors are unlocked by the smart key, the front and rear lamps come on for about 30 seconds as long as any door is not opened. The front and rear room lamps go out gradually after about 30 seconds when the door is closed. However, if the Engine Start/Stop button is in the ON position or all doors are locked, the front and rear lamps will turn off. If a door is opened with the Engine Start/Stop button in the ACC position or the OFF position, the front and rear lamps will stay on for about 5 minutes.

Interior lamp ()

Press the button to turn ON the interior lamp for the front/rear seats.

Rear lamps

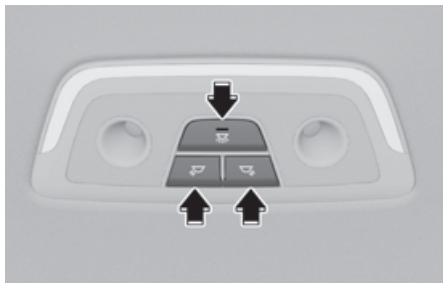

Rear map lamp (☞ ☜)

Press either of these buttons to turn either side of the rear lamp on or off.

Rear interior lamp (☞)

Press this button to turn the interior lamp on or off.

NOTICE

Do not leave the lamp switches on for an extended period of time when the engine is turned off.

Vanity mirror lamp



Opening the lid of the vanity mirror will automatically turn on the mirror lamp.

Glove box lamp

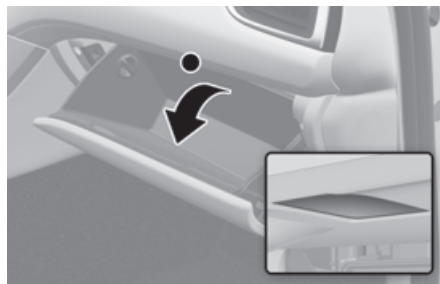

The glove box lamp turns on when the glove box is opened.

NOTICE

Close the glove box after use to prevent unnecessary battery discharge.

Mood lamp/foot lamp

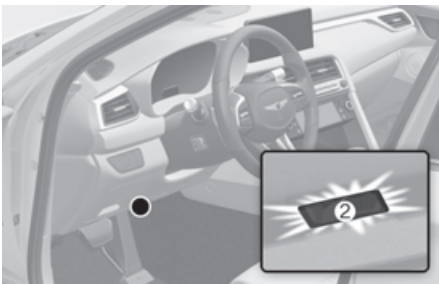

i Information

The infotainment system may change after software updates. For more information, refer to the manual provided in the infotainment system and the quick reference guide.

- Mood lamp (1): The lamp turns on when **Setup (Settings) > Vehicle > Light > Ambient Light** is selected from the infotainment system.
- Door foot lamp (2): The lamp turns on when a door is open and turns off when the door is closed.

Trunk lamp (Sedan)

 if equipped

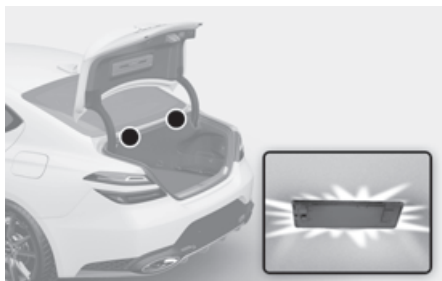

The trunk lamp comes on when the trunk is opened.

The lamp keeps coming on when the trunk is not completely closed.

NOTICE

Close the trunk after use to prevent unnecessary battery discharge.

Tailgate lamp (Shooting Brake)

 if equipped

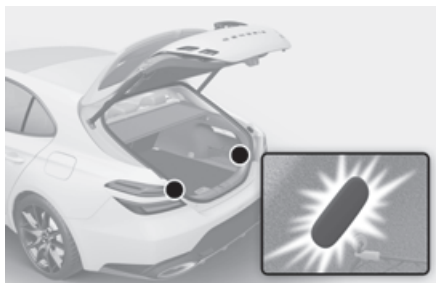

The tailgate lamp comes on when the tailgate is opened.

The lamp keeps coming on when the tailgate is not completely closed.

NOTICE

Close the tailgate after use to prevent unnecessary battery discharge.

Wipers and washers

Sedan (Type A)

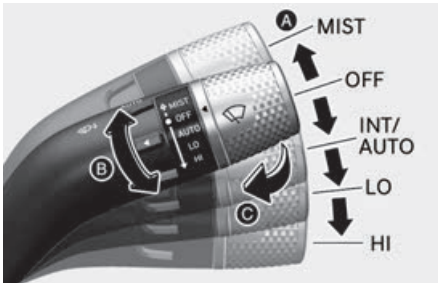

Shooting Brake (Type A)

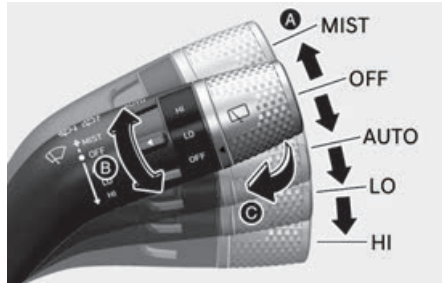

Sedan (Type B)

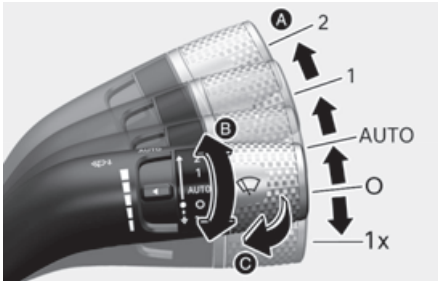

Shooting Brake (Type B)

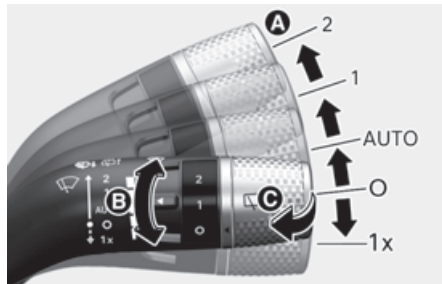

Sedan (Type C)

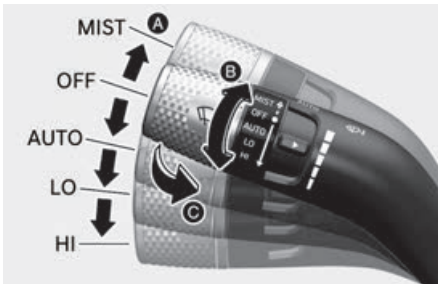

Shooting Brake (Type C)

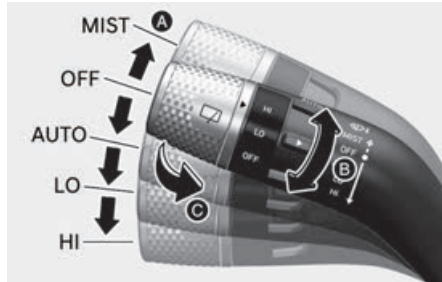

A. Wiper speed control

- **HI/2**: High wiper speed.
- **LO/1**: Low wiper speed.
- **INT/---**: Intermittent wipe.
- **AUTO**(if equipped): Auto control wipe.
- **OFF/O**: Off
- **MIST/1x**: Single wipe

B. Intermittent or Auto control wipe time adjustment

C. Wash with brief wipes (front)

Front windshield wipers

Operates as follows when the engine is turned on.

- **HI/2**: The wiper runs at a higher speed.
- **LO/1**: The wiper runs at a lower speed.
- **INT/---**: Wiper operates intermittently at the same wiping intervals. To vary the speed setting, turn the speed control knob.
- **AUTO**(if equipped): The rain sensor located on the upper end of the windshield glass senses the amount of rainfall and controls the wiping cycle for the proper interval. The more it rains, the faster the wiper operates. When the rain stops, the wiper stops. To vary the speed setting, turn the speed control knob.
- **OFF/O**: Wipers are not in operation.
- **MIST/1x**: For a single wiping cycle, push the lever downward and release. The wipers operate continuously if the lever is held in this position.

i Information

If there is heavy accumulation of snow or ice on the windshield, defrost the windshield for about 10 minutes, or until the snow and/or ice is removed before using the windshield wipers to ensure proper operation.

If you do not remove the snow and/or ice before using the wiper and washer, it may damage the wiper and washer system.

AUTO (Automatic) control

+ if equipped



The rain sensor located on the upper end of the windshield glass senses the amount of rainfall and controls the wiping cycle for the proper interval.

The wiper operation time will be automatically controlled depends on rainfall.

When the rain stops, the wiper stops.

To vary the sensitivity setting, turn the sensitivity control knob.

If the wiper switch is set in AUTO mode when the Engine Start/Stop button is in the ON position, the wiper will operate once to perform a self-check of the system. Set the wiper to the OFF (O) position when the wiper is not in use.

WARNING

To avoid personal injury from the windshield wipers, when the engine is running and the windshield wiper switch is placed in the AUTO mode:

- Do not touch the upper end of the windshield glass facing the rain sensor.
- Do not wipe the upper end of the windshield glass with a damp or wet cloth.
- Do not put pressure on the windshield glass.

NOTICE

- When washing the vehicle, set the wiper switch in the OFF (O) position to stop the auto wiper operation. The wiper may operate and be damaged if the switch is set in the AUTO mode while washing the vehicle.
- Do not remove the sensor cover located on the upper end of the passenger side windshield glass. Damage to system components could occur and may not be covered by your vehicle warranty.
- Because of using a photo sensor, temporary malfunction could occur according to sudden ambient light change made by stone and dust while driving.

Front windshield washers

Sedan



Shooting Brake

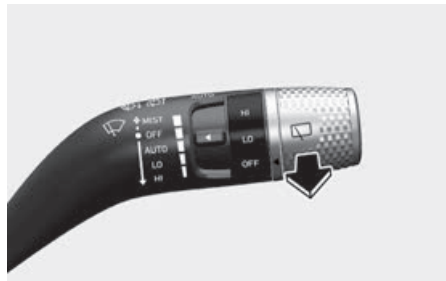

In the OFF (O) position, pull the lever gently toward you to spray washer fluid on the windshield and to run the wipers 1-3 cycles. The spray and wiper operation will continue until you release the lever. If the washer does not work, you may need to add washer fluid to the washer fluid reservoir.

Recirculating air when washer fluid is used

When washer fluid is used, in order to reduce any objectionable scent of the washer fluid from entering the cabin, recirculation mode and air conditioning are automatically activated depending on the outside temperature. If you select fresh mode while the function is operating, the function will resume after a certain amount of time. It may not work in some conditions such as cold weather or engine OFF.

For more information, refer to the "Climate control additional features" section in this chapter.

WARNING

When the outside temperature is below freezing, Always warm the windshield using the defroster to help prevent the washer fluid from freezing on the windshield and obscuring your vision which could result in an accident and serious injury or death.

NOTICE

- To prevent possible damage to the washer pump, do not operate the washer when the fluid reservoir is empty.
- To prevent possible damage to the wipers or windshield, do not operate the wipers when the windshield is dry.
- To prevent damage to the wiper arms and other components, do not attempt to move the wipers manually.
- To prevent possible damage to the wipers and washer system, use anti-freezing washer fluids in the winter season or cold weather.

Rear windshield wipers and washers

 If equipped

Type A

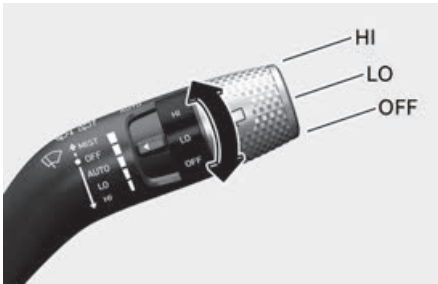

Type B

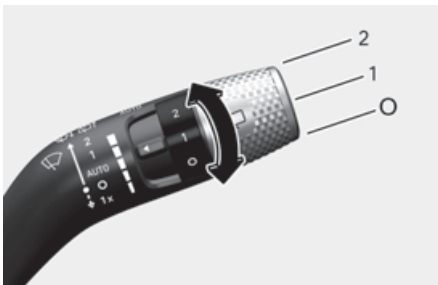

Type C

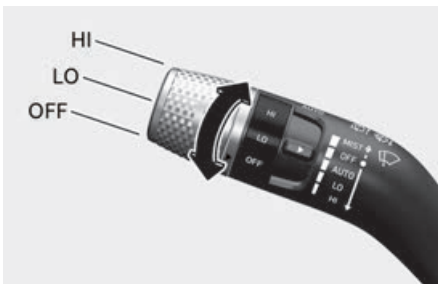

The rear window wiper and washer switch is located at the end of the wiper and washer switch lever. Turn the switch to the desired position to operate the rear wiper and washer.

- **HI/2:** High wiper speed
- **LO/1:** Low wiper speed
- **OFF:** Off



Push the lever away from you to spray rear washer fluid and to run the rear wipers 1-3 cycles. The spray and wiper operation continues until you release the lever.

Auto rear wiper

 If equipped

The rear wiper operates while the vehicle is in reverse with the front wiper on. You can select the function from the Settings menu in the infotainment system. Select:

- **Setup (Settings) > Vehicle > Convenience > Auto rear wiper (reverse)**

i Information

The infotainment system may change after software updates. For more information, refer to the manual provided in the infotainment system and the quick reference guide.

Automatic climate control system

Left-hand drive



The switch arrangements may vary depending on which functions are applicable to your vehicle.

- (1) Driver's temperature control
- (2) Passenger's temperature control
- (3) AUTO (automatic control)
- (4) OFF (system off)
- (5) Front windshield defroster
- (6) Mode selection
- (7) Fan speed control
- (8) A/C (air conditioning)
- (9) SYNC
- (10) Air intake control
- (11) Rear window defroster

Right-hand drive

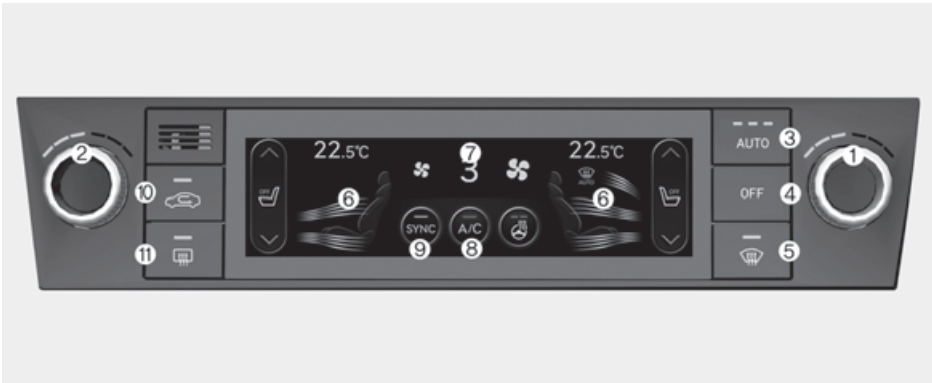

The switch arrangements may vary depending on which functions are applicable to your vehicle.

- (1) Driver's temperature control
- (2) Passenger's temperature control
- (3) AUTO (automatic control)
- (4) OFF (system off)
- (5) Front windshield defroster
- (6) Mode selection
- (7) Fan speed control
- (8) A/C (air conditioning)
- (9) SYNC
- (10) Air intake control
- (11) Rear window defroster

Automatic temperature control mode

The Automatic Climate Control System is controlled by setting the desired temperature.

1. Press the AUTO button.



The mode selection, fan speed, air intake and air conditioning will be controlled automatically by the temperature setting you select.

2. When the climate control system is being automatically controlled, fan speed can be selected (Low/Medium/High).
 - HIGH: Use when quick heating or cooling is preferred.
 - MEDIUM: Use when medium fan speed is preferred for cooling or heating.
 - LOW: Use when low fan speed is preferred for cooling or heating.
3. Turn the temperature control knob to the desired temperature. If the temperature is set to the lowest setting (Lo), the air conditioning system will operate continuously. After the interior has cooled sufficiently, adjust the knob to a higher temperature set point whenever possible.

Driver side/Passenger side



To turn the automatic operation off, select any function of the following:

- Mode selection button
- Front windshield defroster button (Press the button one more time to deselect the front windshield defroster function. The **AUTO** sign will illuminate on the climate information screen once again.)
- Fan speed control icon or knob
- A/C (air conditioning) icon
- Air intake control button

The selected function will be controlled manually while other functions operate automatically.

For your convenience and to improve the efficiency of the climate control, use the AUTO button and set the temperature to 22°C (72°F).

i Information

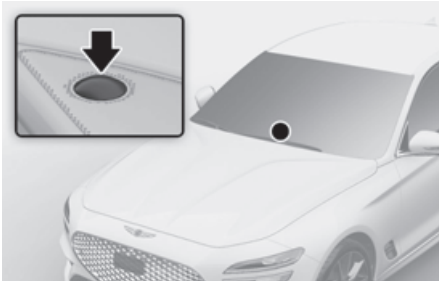

Never place anything near the sensor to ensure better control of the heating and cooling system.

Manual temperature control mode

The heating and cooling system can be controlled manually by pushing buttons other than the AUTO button. In this case, the system works sequentially according to the order of buttons selected.

When pressing any button except the AUTO button while using automatic operation, the functions not selected will be controlled automatically.

1. Start the vehicle.
2. Set the mode to the desired position.
To improve the effectiveness of heating and cooling, select the mode according to the following:
 - Heating:
 - Cooling:
3. Set the temperature control to the desired position.
4. Set the air intake control to Fresh or Recirculation mode.
5. Set the fan speed control to the desired speed.
6. If air conditioning is desired, turn the air conditioning system on.

7. Press the AUTO button to convert to full automatic control of the system.

The climate control system settings will be maintained, even when the vehicle is turned OFF. However, the climate control system settings will be initialized when the battery has been discharged, or when the cables have been disconnected

In this case, adjust the climate control system settings again.

Mode selection

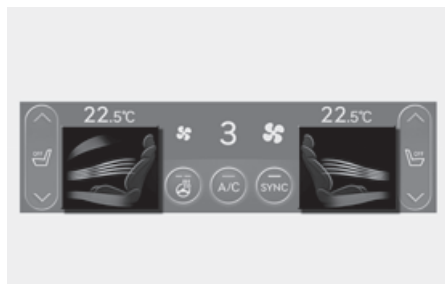

- Touch the arrows on the climate control information screen to select air flow direction.
- Touch SYNC. The SYNC indicator light on the icon turns off, the temperature of the driver's seat and passenger seat can be controlled individually.





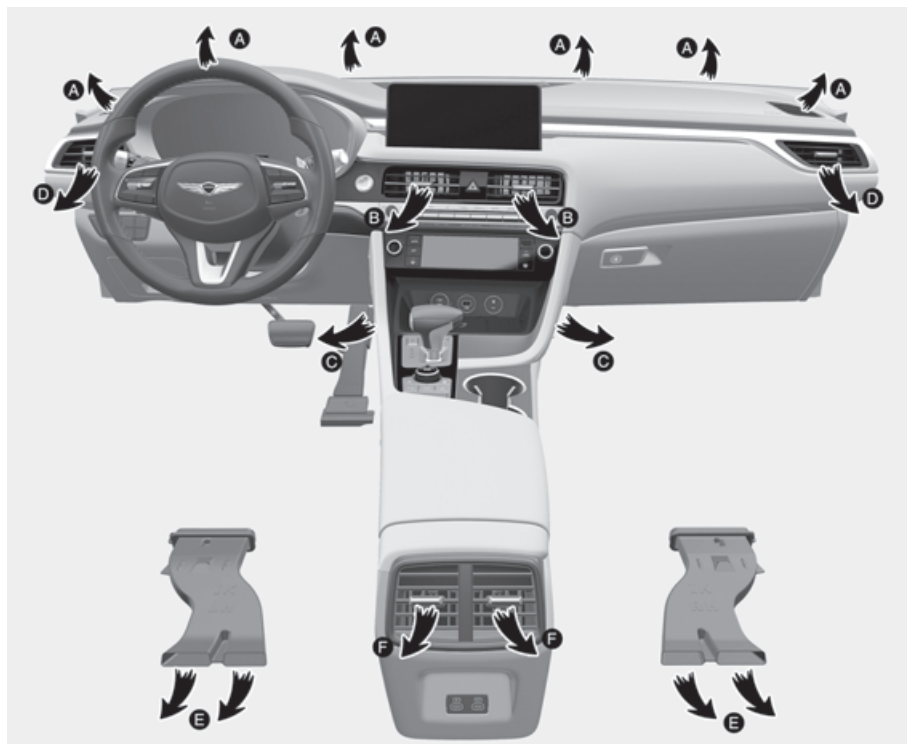

Air flow direction

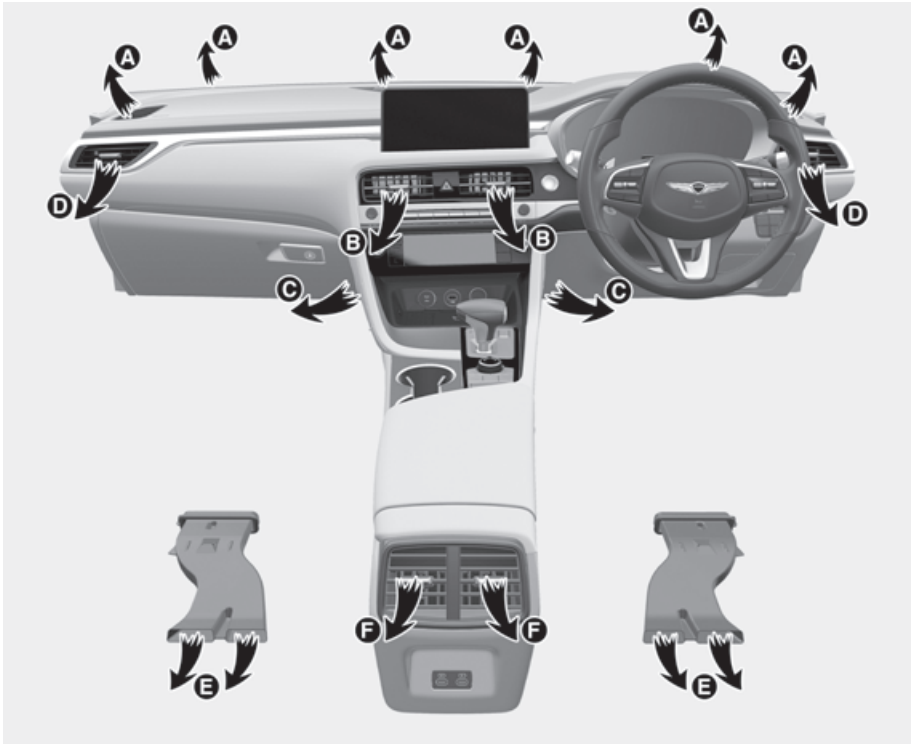
Left-hand drive



Right-hand drive



Symbol	Operation	Direction
	Air flow is directed toward the upper body.	B, D, F
	Air flow is directed toward the upper body and face.	A, B, D, F
	Air flow is directed toward the upper body and floor.	B, C, D, E, F
	Air flow is directed toward the upper body, face and floor.	A, B, C, D, E, F
	Most of the air flow is directed to the floor, with a small amount of the air being directed to the windshield and side window defrosters. This air flow direction is usually used when heating.	A, C, D, E, F
	Most of the air flow is directed to the floor and windshield.	A, C, D, E, F
	Most of the air flow is directed to the windshield.	A, D

Front windshield defroster

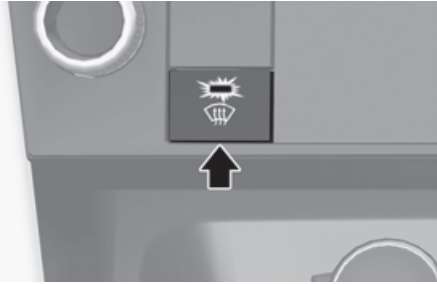

Defrost-level (A, D)

Press the button, and the indicator light on the button will illuminate and the windshield defroster indicator will appear on the climate control information screen.

Most of the air flow is directed to the windshield with a small amount of air directed to the side window defrosters.

When Defogging logic is enabled, Fresh mode is selected and air conditioning is selected according to outside temperature.

Press the button again, the indicator light will turn off and the previous settings will be selected.

Instrument panel vents

Front seat





Rear seat



The instrument panel vent air flow can be directed up/down or left/right using the vent adjustment lever.

The air flow can also be CLOSED using the vent adjustment lever.

Move the lever to  position to close, and to  position to open.

Temperature control

Driver side/Passenger side



- Turn the knob to the red side to increase the temperature. Turn the knob to the blue side to decrease temperature.
- Touch ^ or v icon on the infotainment system to select the temperature.

i Information

The infotainment system may change after software updates. For more information, refer to the manual provided in the infotainment system and the quick reference guide.

SYNC

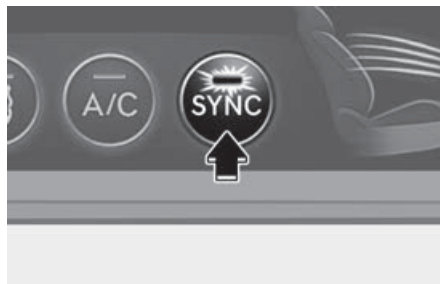

Adjusting the driver and passenger side temperature equally

Touch the **SYNC** icon to adjust the driver and passenger side temperature equally. The button indicator will turn on.

Adjusting the driver and passenger side temperature individually

Touch the **SYNC** icon again to adjust the driver and passenger side temperature individually. The button indicator will turn off.

Temperature conversion

To change the temperature unit from °C to °F or °F to °C:

- Press and hold the **A/C** icon for 3 seconds then release. And within 5 seconds, touch the mode selection button for more than 3 seconds.
- Select **Setup (Settings) > General > Units > Temperature > °C/°F** in the infotainment system.

i Information

The infotainment system may change after software updates. For more information, refer to the manual provided in the infotainment system and the quick reference guide.

Air intake control



The air intake control button is used to select either Fresh mode (outside air) or Recirculation mode (cabin air).

Recirculation mode



When Recirculation mode is selected, air from the passenger compartment will be recirculated through the system and heated or cooled according to the function selected.

Fresh mode



When Fresh mode is selected, air enters the vehicle from outside and is heated or cooled according to the function selected.

i Information

Using the system in the fresh air position is recommended.

Prolonged operation of the heater in the recirculated air position (without air conditioning selected) can cause fogging of the windshield and side windows and the air within the passenger compartment will become stale.

In addition, prolonged use of the air conditioning with the recirculated air position selected will result in excessively dry air in the passenger compartment.

WARNING

To prevent serious injury or death:

- Continued climate control system operation in the recirculated air position may allow humidity to increase inside the vehicle that could fog the windshield and the side windows and obscure visibility.
- Do not sleep in a vehicle with the air conditioning or heating system on.
- Continued climate use of recirculated air may cause drowsiness or sleepiness, and loss of vehicle control. Set the air intake control to the outside (fresh) air position while driving.

Fan speed control

Front seat

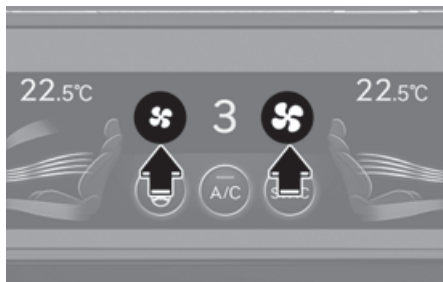

Touch the icon button to increase fan speed and airflow. Touch the left icon to decrease fan speed and airflow.

Pressing the OFF button turns off the fan.

NOTICE

Operating the fan when the Engine Start/Stop button is in the ON position could cause the battery to discharge. Operate the fan when the engine is running.

Air conditioning



Touch the A/C icon to manually turn the air conditioning on (indicator light will illuminate) and off.

OFF mode



Press the OFF button to turn the climate control system off. You can still operate the mode and air intake buttons as long as the Engine Start/Stop button is in the ON position.

Climate control information screen

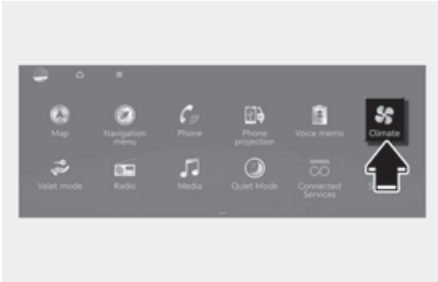

Select **Climate** on the infotainment system.



The climate control information screen appears.

Clean air system





If equipped

When the clean air system is selected, the indoor fine dust concentration is measured by the fine dust sensor equipped in the vehicle and the indoor air status is presented on the screen. If needed, it prevents the contaminated external air and the cabin air filter purifies the indoor air by filtering the fine dust to provide fresh air.



Indoor air status display

The air status is presented with the four levels as below when the climate control system turns on.

Clean Air System	ON				Operation Indicator
Indoor air status	Good	Normal	Poor	Very poor	
	 (Blue)	 (Green)	 (Orange)	 (Red)	

If the indoor air status is poor, the clean air system cleans the indoor air by air conditioning, ventilating, and increasing fan speed.

i Information

- The cabin air filter needs to be replaced per every 15,000 km (10,000 miles) to maximize the efficiency of the clean air system.
- If the vehicle is driven in an inner city area with high air pollution or severe conditions such as dusty or rough roads or the indoor fine dust concentration is not presented as Good on the screen due to prolonged heavy fine dust, have the cabin air filter inspected. If the cabin air filter is contaminated, fine dust concentration may appear as Poor or Very Poor on the screen.
- We recommend using a genuine cabin air filter to maintain the optimal performance of the clean air system.
- Use a genuine Genesis cabin air filter to maintain the optimal performance of the clean air system.

When a cabin air filter that has low dust collection efficiency or poor dust removal performance is used, or if you use a cabin air filter that does not meet the specification, fine dust concentration may appear as Poor or Very Poor on the screen.

- Presented dust concentration is measured inside the vehicle in realtime so the measured value differs from the dust concentration in the atmosphere.
- The presented figure might be varied by the mensuration or measurement locations so please use it as a reference.
- The fine dust concentration value is the result of measuring the number of dust and converting it to the fine dust concentration using an optical method.
- The fine dust concentration appears from 0 to 199.
- The measured fine dust concentration value may be different from the measurement standards of other instruments or products.
 - If the fine dust concentration is high, the displayed fine dust concentration may differ from the actual concentration level.
- The time of concentration level measurement may be delayed since the spread of fine dust is slow.
- Movement around the fine dust sensor interferes with the normal operation of the sensor. The displayed fine dust concentration may differ from the actual concentration level.

- In the following environments, the fine dust concentration can appear differently from the actual level.
 - Hairy products, bugs or pets are present
 - A vacuum cleaner is used
 - Humidity is high
 - A door or window is opened letting the outside air in
 - Outside air from a construction site, factory or ventilator enters
 - A product that generates vapors or fine particles (humidifiers, sprays, etc.) is used
 - Even if the dust is generated by activities such as dusting or cleaning, the fine dust sensor may not respond if the dust is large (PM10 or higher). It will be removed by the cabin air filter.
 - The fine dust concentration level can change by products that cause odor, such as air fresheners, odor removers, and cleaners.
 - In an environment affected by electromagnetic waves or electrical noise, the fine dust concentration can be temporarily displayed high.
 - It may take time to reset the fine dust sensor when the vehicle is turned on.
 - If the air filter is not replaced regularly, fine dust concentration may appear as Poor or Very Poor on the screen.
-

System operation

Cooling/Ventilation

1. Select the Face Level  mode.
2. Set the air intake control to fresh or recirculation mode.
3. Set the temperature control to the desired position.
4. Set the fan speed control to the desired speed.

Heating

1. Select the Floor Level  mode.
2. Set the air intake control to fresh or recirculation mode.
3. Set the temperature control to the desired position.
4. Set the fan speed control to the desired speed.
5. If desired, turn the air conditioning ON with the temperature control knob set to heat in order to dehumidify the air before it enters into the cabin.

If the windshield fogs up, select the Front Defrost  mode.

Operation Tips

- To keep dust or unpleasant fumes from entering the vehicle through the ventilation system, temporarily set the air intake control to the recirculation mode. Return the control to the to Fresh mode when the unpleasant air outside has diminished. This will help keep the driver alert and comfortable.
- To help prevent the inside of the windshield from fogging, set the air intake control to fresh mode and the fan speed to the desired position, turn on the air conditioning system, and adjust the temperature control to the desired temperature.

Air conditioning

Your Genesis Branded Vehicle air conditioning system is filled with R-134a or R-1234yf refrigerant.

1. Start the vehicle.
2. Press the air conditioning button.
3. Set the mode to the Face Level  mode.
4. Set the air intake control to Recirculation mode temporarily to allow the cabin to cool quickly. When the desired temperature in the cabin is reached, change the air intake control back to Fresh mode.
5. Adjust the fan speed control and temperature control to maintain maximum comfort.

When maximum cooling is desired, set the temperature control to the lowest position, then set the fan speed control to the highest setting.

NOTICE

When using the air conditioning system, monitor the engine temperature gauge closely while driving up hills or in heavy traffic when outside temperatures are high. Air conditioning system operation when climbing a steep grade or in high outside ambient temperatures can cause engine overheating. Continue to use the fan, but turn the air conditioning system off if the engine temperature gauge indicates engine overheating.

Air conditioning system operation tips

- If the vehicle has been parked in direct sunlight during hot weather, open the windows for a short time to let the hot air inside the vehicle escape.
- After sufficient cooling has been achieved, switch back from recirculation mode to fresh mode.
- To help reduce moisture inside of the windows on rainy or humid days, decrease the humidity inside the vehicle by operating the air conditioning system with the windows and sunroof closed.
- Use the air conditioning system every month only for a few minutes to ensure maximum system performance.
- If you operate air conditioner excessively, the difference between the temperature of the outside air and that of the windshield could cause the outer surface of the windshield to fog up, causing loss of visibility. In this case, set the mode selection to the windshield position and fan speed control to the lowest speed.

System maintenance

Cabin air filter

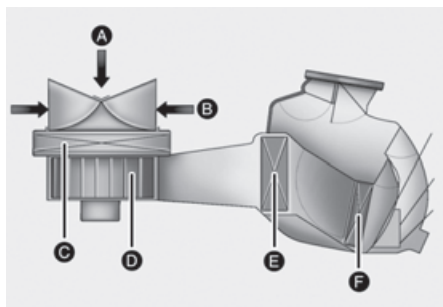

- [A] Outside air
- [B] Recirculated air
- [C] Climate control air filter
- [D] Blower
- [E] Evaporator core
- [F] Heater core

The cabin air filter is installed behind the glove box. It filters the dust or other pollutants that enter the vehicle through the heating and air conditioning system.

We recommend that the cabin air filter be replaced by an authorized retailer of Genesis Branded products according to the maintenance schedule. If the vehicle is being driven in severe conditions such as dusty or rough roads, more frequent cabin air filter inspections and changes are required.

If the air flow rate suddenly decreases, we recommend that the system be inspected at an authorized retailer of Genesis Branded products.

Checking the amount of air conditioner refrigerant and compressor lubricant

When the amount of refrigerant is too low or too high, the performance of the air conditioning is reduced.

Therefore, if abnormal operation is found, we recommend that the system be inspected by an authorized retailer of Genesis Branded products.

NOTICE

It is important that the correct type and amount of oil and refrigerant is used. Otherwise, damage to the compressor and abnormal system operation may occur. To prevent damage, the air conditioning system in your vehicle should only be serviced by trained and certified technicians.

⚠ WARNING

Vehicles equipped with R-134a



Since the refrigerant is operated at very high pressure, the air conditioning system should only be serviced by trained and certified technicians.

All refrigerants should be reclaimed with proper equipment.

Venting refrigerants directly to the atmosphere is harmful to individuals and environment. Failure to heed these warnings can lead to serious injuries.

⚠ WARNING

Vehicles equipped with R-1234yf



Since the refrigerant is mildly flammable and operated at high pressure, the air conditioning system should only be serviced by trained and certified technicians. It is important that the correct type and amount of oil and refrigerant are used.

All refrigerants should be reclaimed with proper equipment.

Venting refrigerants directly to the atmosphere is harmful to individuals and environment. Failure to heed these warnings can lead to serious injuries.

Air Conditioning refrigerant label

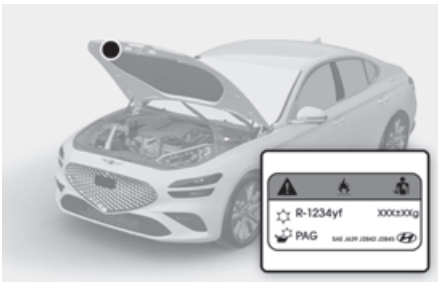

You can find out which air conditioning refrigerant is applied to your vehicle on the label located inside of the hood.

Type A

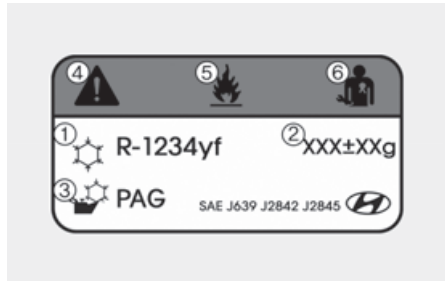

Type B

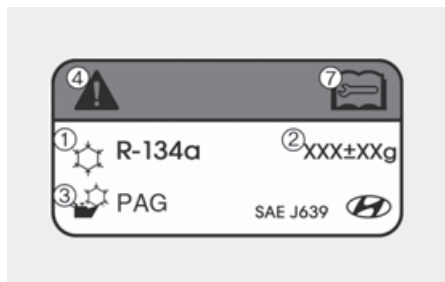



Each symbols and specification on the air conditioning refrigerant label is represented as below:

- (1) Classification of refrigerant
- (2) Amount of refrigerant
- (3) Classification of compressor lubricant
- (4) Caution
- (5) Flammable refrigerant
- (6) To require registered technician to service air conditioning system
- (7) Service manual

Windshield defrosting and defogging

WARNING

Windshield heating

Do not use the  position during cooling operation in extremely humid weather. The difference between the temperature of the outside air and that of the windshield could cause the outer surface of the windshield to fog up, causing loss of visibility could cause an accident resulting in serious injury or death. In this case, set the mode selection button to the  position and fan speed control knob to a lower speed.

- For maximum defrost performance, set the temperature control to the highest temperature setting and the fan speed control to the highest setting.
- If warm air to the floor is desired while defrosting or defogging, set the mode to the floor-defrost position.
- Before driving, clear all snow and ice from the windshield, rear window, outside rearview mirrors, and all side windows.
- Clear all snow and ice from the hood and air inlet in the cowl grill to improve heater and defroster efficiency and to reduce the probability of fogging up the inside of the windshield.

NOTICE

If the engine temperature is still cold after starting, then a brief engine warm up period may be required for the vented air flow to become warm or hot.

To defog inside windshield

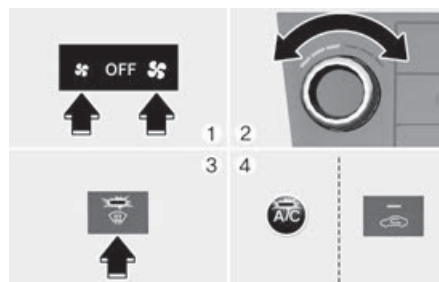

1. Select the desired fan speed.
2. Select the desired temperature.
3. Press the defroster button (.
4. Fresh mode will be selected automatically.

Check to make sure the air intake control is in Fresh mode. If the air intake control indicator light is illuminated, press the button once to enable Fresh mode (indicator light OFF).

If the  position is selected, the fan speed is automatically increased.

To defrost outside windshield

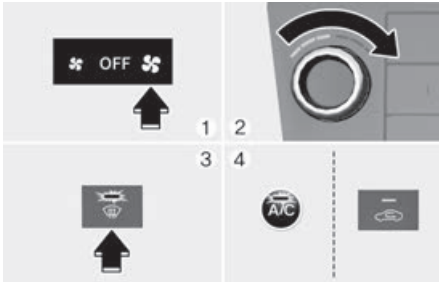

1. Set the fan speed to the highest (extreme right) position.
2. Set the temperature to the extreme hot (HI) position.
3. Press the defroster button (windshield icon).
4. Fresh mode will be selected automatically.

Check to make sure the air intake control is in Fresh mode. If the air intake control indicator light is illuminated, press the button once to enable Fresh mode (indicator light OFF).

If the (windshield icon) position is selected, lower fan speed is adjusted to a higher fan speed.

Defogging logic

To reduce the probability of fogging up the inside of the windshield, the air intake or air conditioning are controlled automatically according to certain conditions such as (windshield icon) positions. To cancel or reset the defogging logic, do the following.

1. Press the Engine Start/Stop button to the ON position.
2. Press the defroster (windshield icon) button .
3. Press the air intake control button at least 5 times within 3 seconds.

The air intake control button indicator will blink 3 times to indicate that the defogging logic has been disabled. Repeat the steps again to re-enable the defogging logic.

If the battery has been discharged or disconnected, it resets to the defog logic status.

Rear window defroster

NOTICE

To prevent damage to the rear window defroster conducting elements bonded to the inside surface of the rear window, never use sharp instruments or window cleaners containing abrasives to clean the window.



The defroster heats the window to remove frost, fog and thin ice from the interior and exterior of the rear window, while the engine is running.

- To activate the rear window defroster, press the rear window defroster button located in the center control panel. The indicator on the rear window defroster button illuminates when the defroster is ON.
- To turn off the defroster, press the rear window defroster button again.

i Information

- If there is heavy accumulation of snow on the rear window, brush it off before operating the rear defroster.
- The rear window defroster automatically turns off after about 20 minutes or when the Engine Start/Stop button is in the OFF position.

Outside rearview mirror defroster

If your vehicle is equipped with the outside rearview mirror defrosters, they will operate at the same time you turn on the rear window defroster.

Climate control additional features

Air conditioning auto-drying

 if equipped

The Air conditioning auto-drying feature dries the moisture in the air conditioner and reduces air conditioner odor. The blower motor automatically operates 30 minutes after the engine is turned off.

Turning Air conditioning auto-drying on or off

The Air conditioning auto-drying feature can be turned on and off by selecting **Setup (Settings) > Vehicle > Climate > Air conditioner auto-drying**.

***i* Information**

The infotainment system may change after software updates. For more information, refer to the manual provided in the infotainment system and the quick reference guide.

If the operating condition is satisfied after setting the feature, the operating condition appears on the infotainment system and the blower motor automatically operates.

When the Air conditioning auto-drying feature is activated, the air conditioner sets the fan speed to the third level, selects outside (fresh) mode, and directs the air flow to the floor and the windshield.

Operating conditions

The Air conditioning auto-drying feature operates under the following conditions:

- The vehicle is turned off after operating the air conditioner for a certain period.

- The battery level is sufficient and the outside temperature is above a certain level.

Non-operating conditions

The Air conditioning auto-drying feature stops operating under the following conditions:

- The A/C Automatic Drying feature has operated for 10 minutes.
- The Engine Start/Stop button is pressed, or the engine is on.
- The climate control system is operated remotely.

***i* Information**

The Air conditioning auto-drying feature reduces air conditioner odors but may not remove all odors.

Auto defogging system

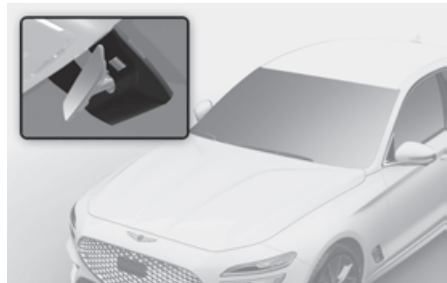

Auto defogging helps reduce the possibility of fogging up the inside of the windshield by automatically sensing the moisture on inside the windshield.

The auto defogging system operates when the heater or air conditioning is on.

***i* Information**

The auto defogging system may not operate normally, when the outside temperature is below -10 °C (14 °F).



When the Auto Defogging System operates, the indicator will illuminate.

If a high amount of humidity is detected in the vehicle, the Auto Defogging System will be enabled. The following steps will be performed automatically:

For Europe

1. Outside air position
2. Increasing air flow toward the windshield
3. Blowing air flow toward the windshield
4. Operating the air conditioning.

Except Europe

1. Operating the air conditioning.
2. Outside air position
3. Blowing air flow toward the windshield
4. Increasing air flow toward the windshield (Step could be changed according to the outside temperature.)

If the air conditioning is off or recirculation mode is manually selected while Auto Defogging System is ON, the Auto Defogging System indicator will blink 3 times to signal that the manual operation has been canceled.

Turning the Auto Defogging System ON or OFF

Climate control system

Press the front windshield defroster button for 3 seconds when the Engine Start/Stop button is in the ON position. When the Auto Defogging System is turned off, the ADS OFF symbol will blink 3 times and ADS OFF appears on the climate control information screen.

When the Auto Defogging System is turned on, the ADS OFF symbol will blink 6 times without a signal.

Infotainment system

Auto Defogging System can be turned on and off by selecting **Setup (Settings) > Vehicle > Climate > Defog/Defrost options > Auto defog** from the infotainment system.

i Information

- The infotainment system may change after software updates. For more information, refer to the manual provided in the infotainment system and the quick reference guide.
- When the air conditioning is turned on by Auto Defogging System, if you try to turn off the air conditioning, the indicator will blink 3 times and the air conditioning will not be turned off.
- To maintain the effectiveness and efficiency of the Auto Defogging System, do not select Recirculation mode while the system is operating.
- When Auto Defogging System is operating, fan speed adjustment, temperature adjustment, and air intake control selection are all disabled.

NOTICE

Do not remove the sensor cover located on the upper end of the windshield glass. Damage to system parts could occur and may not be covered by your vehicle warranty.



Auto dehumidify

 if equipped

To increase cabin air quality and reduce windshield misting, recirculation mode switches off automatically after about 5 to 30 minutes, depending on the outside temperature, and the air intake will change to fresh mode.

Turning Auto Dehumidify ON or OFF

Climate control system

To turn the Auto Dehumidify feature on or off, select Face level () mode and press the air intake control () button at least five times within three seconds. When Auto Dehumidify is turned on, the air intake control button indicator will blink 6 times. When turned off, the indicator will blink 3 times.

Infotainment system

Auto Dehumidify can be turned on and off by selecting **Setup (Settings) > Vehicle > Climate > Automatic Ventilation > Auto Dehumidify** from the infotainment system.

Information



The infotainment system may change after software updates. For more information, refer to the manual provided in the infotainment system and the quick reference guide.

Recirculating air when washer fluid is used

Recirculation mode automatically activates to reduce any objectionable scent of the washer fluid from entering the cabin when the windshield washer is used.

Turning Activate upon Washer Fluid Use ON or OFF

Climate control system

To turn the Activate upon Washer Fluid Use feature on or off, select Floor level () mode, and then press the air intake control () button 5 times within 3 seconds while pressing the A/C icon.

When Activate upon Washer Fluid Use ON is turned on, the air intake control button indicator will blink 6 times. When turned off, the indicator will blink 3 times.

Infotainment system

Activate upon Washer Fluid Use can be turned on and off by selecting **Setup (Settings) > Vehicle > Climate > Internal air circulation > Activation on washer fluid use** from the infotainment system.

Information

The infotainment system may change after software updates. For more information, refer to the manual provided in the infotainment system and the quick reference guide.

However, in cold weather to prevent the windshield from fogging up, the recirculation mode may not be selected.

Sunroof inside air recirculation

 if equipped

When the sunroof is opened, fresh mode will be automatically selected. At this time, if you press the air intake control button, recirculation mode will be selected but will change back to fresh mode after 3 minutes. When the sunroof is closed, the air intake position will return to the original position that was selected.

Warmer/ventilation based on climate settings (for driver's seat)

The temperature of the driver's seat warmer, air ventilated seat and heated steering wheel is automatically controlled depending on the inside and outside temperature of the vehicle when the engine is running.

To use these features, it must be enabled from the Settings menu in the infotainment system. Select:

- **Setup (Settings) > Vehicle > Seat > Warmer/Ventilation features > Warmer/ventilation based on climate settings**

i Information

The infotainment system may change after software updates. For more information, refer to the manual provided in the infotainment system and the quick reference guide.

For more information on Auto Comfort Control, refer to the "Seat warmers" and "Air ventilation seats" section in chapter 3 and "Heated steering wheel" section in chapter 5.

Climate touchscreen haptic intensity

Adjustment of the haptic intensity when using the climate touchscreen.

Climate touchscreen haptic intensity can be set by selecting

Setup (Settings) > Vehicle > Climate > Climate Features > Climate touchscreen haptic intensity > Strong/Medium/Light/Off from the infotainment system.

i Information

The infotainment system may change after software updates. For more information, refer to the manual provided in the infotainment system and the quick reference guide.

Storage compartment

WARNING

Never store cigarette lighters, propane cylinders, or other flammable/explosive materials in the vehicle. These items may catch fire and/or explode if the vehicle is exposed to hot temperatures for extended periods.

WARNING

Always keep the storage compartment covers closed securely while driving. Items inside your vehicle are moving as fast as the vehicle. If you have to stop or turn quickly, or if there is a crash, the items may fly out of the compartment and may cause an injury if they strike the driver or a passenger.

NOTICE

To avoid possible theft, do not leave valuables in the storage compartments.

Center console storage



To open:
Press the button.

Glove box

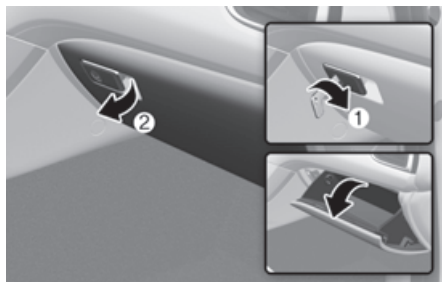

The glove box can be locked and unlocked with the mechanical key (1).

To open:

Pull the lever (2).

WARNING

Always close the glove box door after use.

An open glove box door can cause serious injury to the passenger in an accident, even if the passenger is wearing a seat belt.

Sunglass holder



To open:

Push and release the cover and the holder will slowly open. Place your sunglasses in the compartment door with the lenses facing out.

To close:

Push back into position.

Make sure the sunglasses holder is closed while driving.

WARNING

- Do not keep objects except sunglasses inside the sunglasses holder. Such objects can be thrown from the holder in the event of a sudden stop or an accident, possibly injuring the passengers in the vehicle.
- Do not open the sunglasses holder while the vehicle is moving. The rearview mirror of the vehicle can be blocked by an open sunglasses holder.
- Do not put the glasses forcibly into a sunglasses holder. It may cause personal injury if you try to open it forcibly when the glasses are jammed in holder.

Interior features

Cup holder

Front

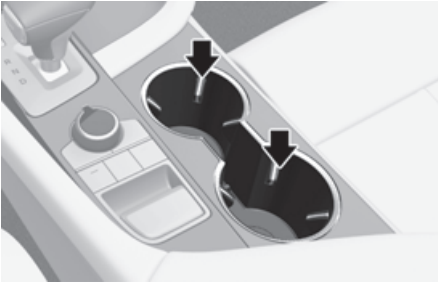

Rear



Cups or small beverages cups may be placed in the cup holders.

WARNING

- Avoid abrupt starting and braking when the cup holder is in use to prevent spilling your drink. If hot liquid spills, you could be burned. Such a burn to the driver could cause loss of vehicle control resulting in an accident.
- Do not place uncovered or unsecured cups, bottles, cans, etc., in the cup holder containing hot liquid while the vehicle is in motion. Injuries may result in the event of a sudden stop or collision.
- Only use soft cups in the cup holders. Hard objects can injure you in an accident.

WARNING

Keep cans or bottles out of direct sun light and do not put them in a hot vehicle. It may explode.

NOTICE

- Keep your drinks sealed while driving to prevent spilling your drink. If liquid spills, it may get into the vehicle's electrical/electronic system and damage electrical/electronic parts.
- When cleaning spilled liquids do not use hot air to blow out or dry the cup holder. This may damage the interior.

Ashtray

 if equipped



To use the ashtray, open the cover.

To clean the ashtray:

The plastic receptacle should be removed by lifting the plastic ashtray receptacle upward after turning the cover counterclockwise and pulling it out.

WARNING

Putting lit cigarettes or matches in an ashtray with other combustible materials may cause a fire.

Sunvisor

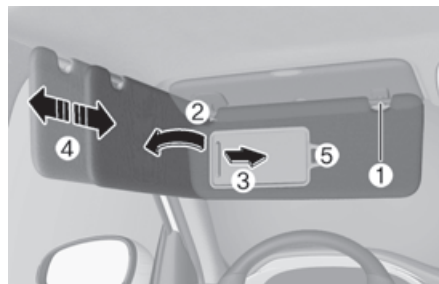

To use the sunvisor, pull it downward.

To use the sunvisor to block the sun from the side window, pull it downward, release it from the bracket (1) and swing it to the side (2) towards the window.

To use the vanity mirror, pull down the sunvisor and slide the mirror cover (3).

Adjust the sunvisor forward or backward (4) as needed. Use the ticket holder (5) to hold tickets.

Close the vanity mirror cover securely and return the sunvisor to its original position after use.

WARNING

Do not block your view when using the sunvisor.

i Information

- The tab (5) adjacent to the vanity mirror on the sunvisor can be used for toll road tickets or self parking tickets. Use caution when inserting tickets into the ticket holder to avoid damage. Refrain from putting several tickets in the ticket holder as this could also damage the retaining tab.
- Always close the mirror cover when the vanity mirror is not in use. If the sunvisor is closed without the lamp off, it may discharge the battery or damage the sunvisor.

Power outlet

Front



Tailgate (Shooting Brake)

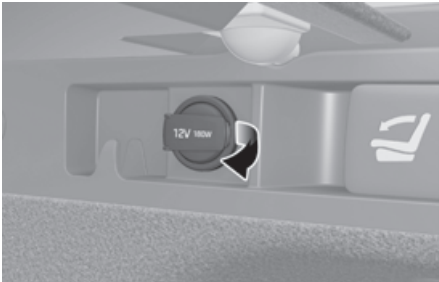

The power outlet is designed to provide power for mobile telephones or other devices designed to operate with vehicle electrical systems. The devices should draw less than 180 W with the engine running.

WARNING

Avoid electrical shocks. Do not place your fingers or foreign objects (pin, etc.) into a power outlet or touch the power outlet with a wet hand.

NOTICE

To prevent damage to the power outlets:

- Use the power outlet only when the engine is running and remove the accessory plug after use. Using the accessory plug for prolonged periods of time with the engine off may cause the battery to discharge.
- Only use 12V electric accessories which are less than 180 W in electric capacity.
- Adjust the air conditioner or heater to the lowest operating level when using the power outlet.
- Close the cover when not used.
- Some electronic devices can cause electronic interference when plugged into a vehicle's power outlet. These devices may cause excessive audio static and malfunctions in other electronic systems or devices used in your vehicle.
- Push the plug in as far as it goes. If good contact is not made, the plug may overheat and the fuse may open.
- Only connect devices with reverse current protection or the current from the device battery may cause the vehicle's electrical/electronic system to malfunction.

USB charger

 if equipped

The USB charger is designed to recharge batteries of small size electrical devices using a USB cable.

Front A



Front B



Rear



The electrical devices can be recharged when the Engine Start/Stop button is in the ON (or START) position.

- The battery charging state may be monitored on the electronic device.
- Disconnect the USB cable from the USB port after use.

- A smartphone or a tablet PC may get warmer during the recharging process. It does not indicate any malfunction with the charging system.
- A smartphone or a tablet PC that does not use a USB cable to charge should be charged using its own charger.
- Do not attempt to use the charging terminal either to turn on an audio or to play media with the infotainment system.
- Charging may not be possible when using a Type-C to A converter sold by a mobile phone manufacturer or commercially available.

NOTICE

- Use the USB charger when the vehicle is running. Using the USB charger for prolonged periods of time with the Start/Stop button in the off position (vehicle off) may cause the battery to discharge.
- To prevent damage to the USB charger:
 - Do not insert foreign objects or spill liquid into the outlet. The USB charging terminal may be damaged.
 - Do not use devices with working current exceeding 3,000 mA (3.0 A).
- When charging an electrical device by using an USB converting adapter (C to A type), use a genuine adapter specified for your vehicle. A commonly used adapter is not equipped with any measures to prevent over current and maintain stability.

Using an unspecified cable may damage the vehicle's USB charger or the connected devices. Contact an authorized retailer of Genesis Branded products for more information on accessories for vehicles.

- The use of non-genuine parts may damage the USB port and infotainment system. Damage cannot be covered by your vehicle warranty.

Wireless smartphone charging system

 If equipped

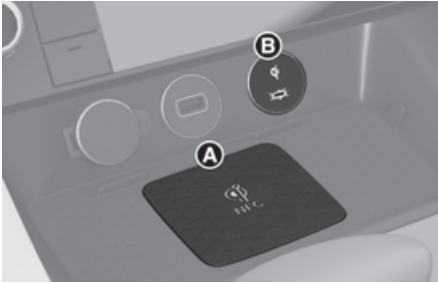

[A] Charging pad
[B] Indicator light

Charging smartphone

The wireless smartphone charging system charges only the Qi-enabled smartphones (Qi). Read the label on the smartphone accessory cover or visit your smartphone manufacturer's website to check whether your smartphone supports the Qi technology.

The wireless charging process starts when you put a Qi-enabled smartphone on the wireless charging with the screen facing up.

1. Remove other items, including the smart key, from the wireless charging unit. If not, the wireless charging process may be interrupted.
2. The system is available when all doors are closed, and when the Start/Stop button is in the ON or START position.

3. Turn on the wireless charging function in the infotainment system.

- Select **Setup (Settings) > Vehicle > Convenience > Wireless charging system**

i Information

The infotainment system may change after software updates. For more information, refer to the manual provided in the infotainment system and the quick reference guide.

4. Place the smartphone on the center of the wireless charging pad. The indicator light is orange when the smartphone is charging and turns green when phone charging is complete.

If your smartphone is not charging:

- Slightly change the position of the smartphone on the charging pad.
- Make sure the indicator light is orange.

The indicator light will blink orange for 10 seconds if there is a malfunction in the wireless charging system.

In this case, temporarily stop the charging process, and re-attempt to charge your smartphone again.

The system warns you with a message on the display if the smartphone is still on the wireless charging unit after the vehicle is turned OFF and the front door is opened.

For some manufacturer's smartphones, the system may not warn you even though the smartphone is left on the wireless charging unit. This is due to the particular characteristic of the smartphone and not a malfunction of the wireless charging.

NOTICE

- The wireless smartphone charging system may not support certain smartphones, which are not verified for the Qi specification (Ⓢ).
- When placing your smartphone on the charging pad, position the phone in the middle of the mat for optimal charging performance. If your smartphone is off to the side, the charging rate may be less and in some cases the smartphone may experience higher heat conduction.
- Wireless charging may stop temporarily when the smart key is used, either when starting the vehicle or locking/unlocking the doors, etc.
- When charging certain smartphones, the charging indicator may not change to blue when the smartphone is fully charged.
- The wireless charging process may temporarily stop, when temperature abnormally increases inside the wireless smartphone charging system. The wireless charging process restarts, when temperature falls to a certain level.
- If any metallic object, such as coins, is located between the wireless charging system and the smartphone, the charging may be disrupted. Also, the metallic object may heat up.
- When charging some smartphones with a self-protection feature, the wireless charging speed may decrease and the wireless charging may stop.
- If the smartphone has a thick cover, the wireless charging may not be possible.
- If the smartphone is not completely contacting the charging pad, wireless charging may not operate properly.
- Smartphone that do not have a built-in wireless charging need to purchase accessories.
- Some magnetic items like credit cards, phone cards or rail tickets may be damaged if left with the smartphone during the charging process.
- When any smartphone without a wireless charging function or a metallic object is placed on the charging pad, a small noise may sound. This small sound is due to the vehicle discerning compatibility of the object placed on the charging pad. It does not affect your vehicle or the smartphone in any way.
- Some smartphones may not be able to charge depending on the internal structure of the smartphone. If this occurs, try charging the smartphone by moving it to the left or right side of the wireless charging pad. However, for some fold-able smartphones that have magnets inside the smartphone, try charging the smartphone while holding it close to the left side of the wireless charging pad.
- For flip type smartphones, when using wireless charging, place the smartphone folded with the device's back placed on the center of the wireless charging unit.
- During wireless charging, an internal fan operates to prevent overheating. Fan noise may sound.

i Information

If the Engine Start/Stop button is in the OFF position, the charging also stops.

Clock

The clock can be set from the infotainment system.

i Information

The infotainment system may change after software updates. For more information, refer to the manual provided in the infotainment system and the quick reference guide.

! WARNING

Do not attempt to adjust the clock while driving.

Coat hook

Type A

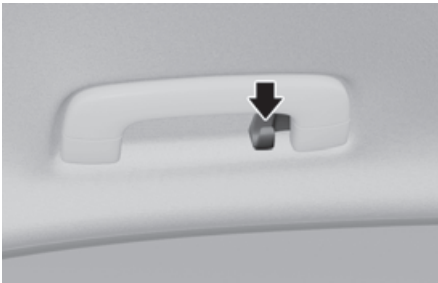

Type B



These hooks are not designed to hold large or heavy items.

! WARNING

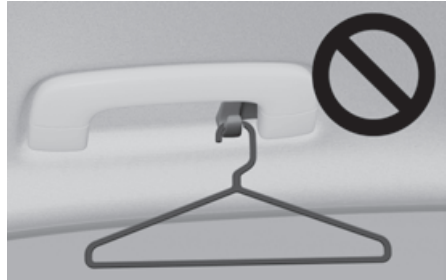

Do not hang other objects such as hangers or hard objects except clothes. Also, do not put heavy, sharp or breakable objects in the clothes pockets. In an accident or when the curtain airbag is inflated, it may cause vehicle damage or personal injury.

Floor mat anchor(s)

Always use the Floor Mat Anchors to attach the front floor mats to the vehicle. The anchors on the front floor carpet keep the floor mats from sliding forward.

! WARNING

Do not overlay additional mats or liners over the floor mats. If using All Weather mats, remove the carpeted floor mats before installing them. Only use floor mats designed to connect to the anchors.

WARNING

The following must be observed when installing ANY floor mat to the vehicle.

- Ensure to remove a protective film attached on the carpet before attaching a floor mat on the front floor carpet. Otherwise, the floor mat may move freely on the protective film and it could result in unintentional braking or accelerating.
- Ensure that the floor mats are securely attached to the vehicle's floor mat anchor(s) before driving the vehicle.
- Do not use ANY floor mat that cannot be firmly attached to the vehicle's floor mat anchors.
- Do not stack floor mats on top of one another (e.g. all-weather rubber mat on top of a carpeted floor mat). Only a single floor mat should be installed in each position.

IMPORTANT Your vehicle was manufactured with driver's side floor mat anchors that are designed to securely hold the floor mat in place. To avoid any interference with pedal operation, Genesis Branded Vehicle recommends that the Genesis floor mat designed for use in your vehicle be installed.

Luggage net holder

 if equipped



Sedan

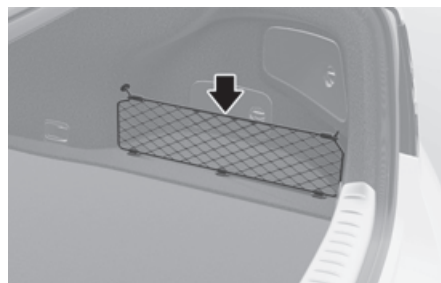

Shooting Brake

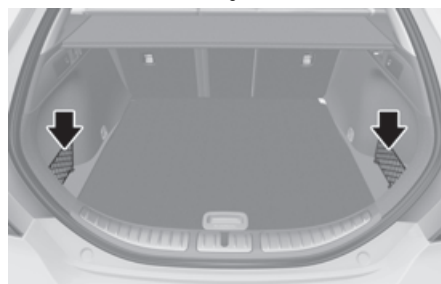

To keep items from shifting in the cargo area, you can use the 4 holders located in the luggage board to attach the luggage net.

Make sure the luggage net is securely attached to the holders in the luggage board.

If necessary, we recommend that you contact your authorized retailer of Genesis Branded products to obtain a luggage net.

WARNING

- Avoid eye injury. DO NOT overstretch the luggage net. Always keep your face and body out of the luggage net's recoil path. DO NOT use the luggage net when the strap has visible signs of wear or damage.
- Use the luggage net to keep only light items from shifting in the cargo area .

Shopping holder

 If equipped

Shooting Brake

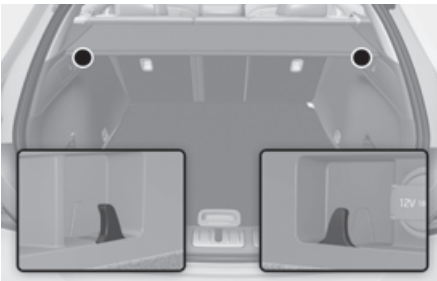

The shopping holders are located on the left and right side of the cargo area.

CAUTION

- Do not hang a bag weighing more than 3 kg (7 lbs.). It may cause damage to the shopping holder.
- Do not hang fragile objects when you drive on rough roads, the objects may be damaged.

Infotainment system

NOTICE

- If you install an aftermarket HID head lamp, your vehicle's audio and electronic devices may not function properly.
- Prevent chemicals such as perfume, cosmetic oil, sun cream, hand cleaner, and air freshener from contacting the interior parts because they may cause damage or discoloration.

USB Port



- You can use a USB cable to connect audio devices to the vehicle USB port.
- After connecting a media storage device such as a MP3 or USB to the USB port, you can listen to music through the vehicle's speakers or play it on the infotainment system.
- Small electronic devices can be charged.

i Information

- Some devices may not be charged through USB port.
- When using a portable audio device connected to the power outlet, noise may occur during playback. If this happens, disconnect the USB cable and use the portable audio device's power source.

i Information

- When connecting a Type-A USB or a memory device to a vehicle, use a genuine converting adapter (C to A type) specified for your vehicle. A commonly used adapter is not equipped with any measures to reduce noise, prevent overcurrent and maintain stability. Connecting an unspecified cable may damage the vehicle's USB port or the connected devices. Contact an authorized retailer of Genesis Branded products for more information on accessories for vehicles.
- The use of non-genuine parts may damage the USB port and infotainment system. Damage cannot be covered by your vehicle warranty.

Antenna

Sedan

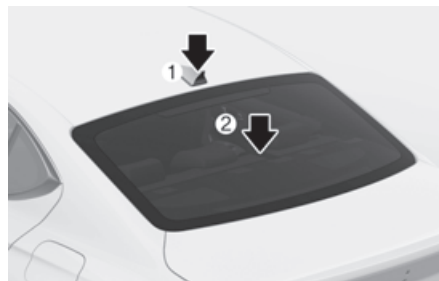

- (1) Shark fin antenna: The shark fin antenna receives transmitted data. (for example: tms, GNSS, LTE, etc)
- (2) Glass antenna: Your vehicle uses a glass antenna to receive both AM and FM signals.

Shooting Brake

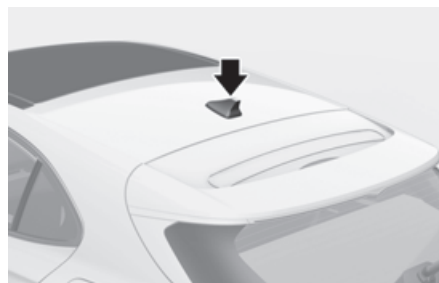

The shark fin antenna will receive AM, FM broadcast signals and transmit data.

Steering wheel remote controls



NOTICE

Do not operate multiple audio remote control buttons simultaneously.

VOLUME (VOL + / VOL -) (1)

- Rotate the VOLUME scroll up to increase volume.
- Rotate the VOLUME scroll down to decrease volume.

SEEK/PRESET (∧ / ∨) (2)

If the SEEK/PRESET switch is pressed up or down and held for 0.8 second or more, it will function in the following modes:

RADIO mode

It will function as the AUTO SEEK select button. It will SEEK until you release the button.

MEDIA mode

It will function as the FF/RW button.

If the SEEK/PRESET switch is pressed up or down, it will function in the following modes:

RADIO mode

It will function as the PRESET STATION UP/DOWN button.

MEDIA mode

It will function as the TRACK UP/DOWN button.

MODE (3)

Press the MODE button to toggle through Radio or AUX modes.

MUTE (嗽) (4)

- Press the MUTE button to mute the sound.
- Press the MUTE button again to activate the sound.

i Information

The infotainment system may change after software updates. For more information, refer to the manual provided in the infotainment system and the quick reference guide.

Infotainment system



i Information

The infotainment system may change after software updates. For more information, refer to the manual provided in the infotainment system and the quick reference guide.

Voice recognition



i Information

The infotainment system may change after software updates. For more information, refer to the manual provided in the infotainment system and the quick reference guide.

Bluetooth® Wireless Technology



- (1) Call/Answer/Call end button
- (2) Microphone

i Information

The infotainment system may change after software updates. For more information, refer to the manual provided in the infotainment system and the quick reference guide.

⚠ CAUTION

To avoid driver distractions, do not excessively operate the device while driving the vehicle which may lead to an accident.

Lexicon premium sound system

 if equipped

⚠ CAUTION

Lexicon premium sound system is equipped with door speaker grills made of stainless steel. The grill surface can be heated when the vehicle is exposed to hot weather for a long period of time. Keep away from the speaker grill when it is hot.

6. Driving your vehicle

Before driving	6-3
Before entering the vehicle.....	6-4
Before starting	6-4
Engine Start/Stop button.....	6-5
Engine Stop/Start button positions.....	6-6
Starting the engine	6-7
Turning off the engine	6-8
Remote start.....	6-9
Automatic transmission	6-10
Automatic transmission operation	6-11
Paddle shifter (Manual shift mode).....	6-16
Cluster display messages (cluster).....	6-16
Good driving practices	6-22
Braking system	6-23
Power brakes.....	6-23
High Performance Brake	6-24
Disc brakes wear indicator	6-25
Electronic Parking Brake (EPB).....	6-25
Auto Hold.....	6-31
Anti-lock Brake System (ABS).....	6-35
Electronic Stability Control (ESC).....	6-36
Vehicle Stability Management (VSM).....	6-39
Hill-Start Assist Control (HAC).....	6-40
Emergency Stop Signal (ESS).....	6-40
Multi-Collision Brake (MCB).....	6-41
Brake Assistant System (BAS).....	6-42
Good braking practices	6-42
All Wheel Drive (AWD).....	6-43
All Wheel Drive (AWD) operation.....	6-44
Emergency precautions	6-45
Limited Slip Differential	6-47
Electronic control suspension	6-47
System malfunction.....	6-47
Launch control.....	6-48
Prerequisite for activation.....	6-48
Launch Control activation.....	6-48

Limited use of Launch Control	6-49
Idle Stop and Go (ISG)	6-50
ISG system operation	6-50
ISG system off	6-52
Forced to restart engine	6-52
ISG malfunction	6-53
Calibrating the Battery Sensor	6-53
Coasting.....	6-54
Coasting setting	6-54
Coasting operating conditions	6-54
Coasting release conditions	6-55
Drive mode integrated control system	6-56
Drive mode	6-56
Vehicle characteristic.....	6-59
Semi active engine mount.....	6-60
Active air flap.....	6-60
Malfunction.....	6-61
Special driving conditions	6-61
Hazardous driving conditions.....	6-61
Rocking the vehicle.....	6-62
Smooth cornering.....	6-62
Driving at night.....	6-63
Driving in the rain	6-63
Driving in flooded areas	6-64
Highway driving.....	6-64
Winter driving.....	6-65
Snow or icy conditions.....	6-65
Winter precautions.....	6-67
Vehicle weight.....	6-69
Overloading	6-70
Trailer towing	6-70

Before driving

WARNING

Carbon monoxide (CO) gas is toxic. Breathing CO may cause unconsciousness and death.

Engine exhaust contains carbon monoxide that cannot be seen or smelled.

Do not inhale engine exhaust.

If at any time you smell engine exhaust inside the vehicle, open the windows immediately. Exposure to CO may cause unconsciousness and death by asphyxiation.

Make sure the exhaust system does not leak.

Be sure to check the exhaust system whenever the vehicle is raised to change the oil or for any other purposes. If you hear a change in the sound of the exhaust or drive over something that strikes the underneath side of the vehicle, we recommend that the exhaust system be inspected as soon as possible by an authorized retailer of Genesis Branded products.

Do not run the engine in an enclosed area.

Letting the engine idle in your garage, even with the garage door open, is a hazardous practice. Run the engine only long enough to start the engine and to move the vehicle out of the garage.

Avoid idling the engine for an extended period of time with people inside the vehicle.

If it is necessary to idle the engine for a long time with people inside the vehicle, be sure to do so only in an open area with the air intake set at “Fresh” and fan control set to high so fresh air is drawn into the interior.

Keep the air intakes clear.

To ensure proper operation of the ventilation system, keep the ventilation air intakes located in front of the windshield clear of snow, ice, leaves, or other obstructions.

If you must drive with the trunk (or tailgate) open:

Close all windows.

Open instrument panel air vents.

Set the air intake control at “Fresh”, the air flow control at “Floor” or “Face”, and the fan control set to high.

Before entering the vehicle

- Be sure all windows, outside mirror(s), and outside lights are clean and unobstructed.
- Remove frost, snow, or ice.
- Visually check the tires for uneven wear and damage.
- Check under the vehicle for any sign of leaks.
- Be sure there are no obstacles behind you if you intend to back up.

Before starting

- Make sure the hood, the trunk (or tailgate), and the doors are securely closed and locked.
- Adjust the position of the seat and steering wheel.
- Adjust the inside and outside rearview mirrors.
- Verify all the lights work.
- Fasten your seat belt. Check that all passengers have fastened their seat belts.
- Check the gauges and indicators in the instrument panel and the messages on the instrument cluster display when the Engine Start/Stop button is in the ON position.
- Check that any items you are carrying are stored properly or fastened down securely.

WARNING

To reduce the risk of **SERIOUS INJURY** or **DEATH**, take the following precautions:

- Always wear your seat belt. All passengers must be properly belted whenever the vehicle is moving. For more information, refer to the “Seat belts” section in chapter 3.
 - Always drive defensively. Assume other drivers or pedestrians may be careless and make mistakes.
 - Stay focused on the task of driving. Driver distraction can cause accidents.
 - Leave plenty of space between you and the vehicle in front of you.
-

WARNING

Never drink or take drugs and drive.

Drinking or taking drugs and driving is dangerous and may result in an accident and **SERIOUS INJURY** or **DEATH**.

Drunk driving is the number one contributor to the highway death toll each year. Even a small amount of alcohol will affect your reflexes, perceptions and judgment. Just one drink can reduce your ability to respond to changing conditions and emergencies. Your reaction time gets worse with each additional drink.

Driving while under the influence of drugs is as dangerous as or more dangerous than driving under the influence of alcohol.

You are much more likely to have a serious accident if you drink or take drugs and drive. If you are drinking or taking drugs, don't drive. Do not ride with a driver who has been drinking or taking drugs. Choose a designated driver or call a taxi.

Engine Start/Stop button



Whenever the front door is opened, the Engine Start/Stop button will illuminate and will go off 30 seconds after the door is closed.

WARNING

To turn the vehicle off in an emergency: Press and hold the Engine Start/Stop button for more than two seconds OR Rapidly press and release the Engine Start/Stop button three times (within three seconds).

If the vehicle is still moving, you can restart the vehicle without depressing the brake pedal by pressing the Engine Start/Stop button with the gear in the N (Neutral) position.

WARNING

- Never press the Engine Start/Stop button while the vehicle is in motion except in an emergency. This will result in the vehicle turning off and loss of power assist for the steering and brake systems. This may lead to loss of directional control and braking function, which could cause an accident.
- Before leaving the driver's seat, always make sure the gear is in the P (Park) position, set the parking brake, press the Engine Start/Stop button to the OFF position, and take the smart key with you. Unexpected vehicle movement may occur if these precautions are not followed.
- Never reach through the steering wheel for the Engine Start/Stop button or any other control while the vehicle is in motion. The presence of your hand or arm in this area may cause a loss of vehicle control resulting in an accident.

Engine Stop/Start button positions

Button Position	Action	Notes
OFF	To turn off the engine, press the Engine Start/Stop button with the vehicle shifted to P (Park). If the Engine Start/Stop button is pressed with the vehicle shifted to D (Drive), R (Reverse) or N (Neutral), the gear automatically shift to P (Park). The steering wheel locks to protect the vehicle from theft.	If the steering wheel is not locked properly when you open the driver's door, the warning chime will sound.
ACC	Press the Engine Start/Stop button when the button is in the OFF position without depressing the brake pedal. Some of the electrical accessories are usable. The steering wheel unlocks.	<ul style="list-style-type: none"> If you leave the Engine Start/Stop button in the ACC position for more than one hour, the battery power will turn off automatically to prevent the battery from discharging. If the steering wheel doesn't unlock properly, the Engine Start/Stop button will not work. Press the Engine Start/Stop button while turning the steering wheel right and left to release.
ON	Press the Engine Start/Stop button while it is in the ACC position without depressing the brake pedal. The warning lights can be checked before the engine is started.	Do not leave the Engine Start/Stop button in the ON position when the engine is not running to prevent the battery from discharging.
START	To start the engine, depress the brake pedal and press the Engine Start/Stop button with the gear shifted to the P (Park) or the N (Neutral) position. For your safety, start the engine with the gear shifted to the P (Park) position.	If you press the Engine Start/Stop button without depressing the brake pedal, the engine does not start and the Engine Start/Stop button changes as follows: OFF > ACC > ON > OFF or ACC

i Information

To prevent vehicle battery discharge, the Engine Start/Stop button changes to the OFF position when the Engine Start/Stop button is in the ACC or ON position with the gear in P (Park) for a certain period of time. When the function operates, the tail lights will turn off. To use the tail lights again, turn the headlight switch located on the steering column to the OFF and ON position again.

Starting the engine

WARNING

- Always wear appropriate shoes when operating your vehicle. Unsuitable shoes, such as high heels, ski boots, sandals, flip flops, etc., may interfere with your ability to use the brake and accelerator pedals.
- Do not start the vehicle with the accelerator pedal depressed.
The vehicle can move which can lead to an accident.
- Wait until the engine rpm is normal. The vehicle may suddenly move if the brake pedal is released when the rpm is high.

Information

- The vehicle will start by pressing the Engine Start/Stop button, only when the smart key is in the vehicle.
- Even if the smart key is in the vehicle, and when it is far away from the driver, the engine may not start.
- When the Engine Start/Stop button is in the ACC or ON position, if any door is open, the system checks for the smart key. When the smart key is not in the vehicle, the “” indicator will blink and the warning “**Key not in vehicle**” will come on. When all doors are closed, the chime will also sound for about 5 seconds. Keep the smart key in the vehicle.

Starting the gasoline engine



1. Always carry the smart key with you.
2. Make sure the parking brake is applied.
3. Make sure the gear is shifted to P (Park) by pressing the P button.
4. Depress the brake pedal.
5. Press the Engine Start/Stop button.

Information

- Do not wait for the engine to warm up while the vehicle remains stationary.
Start driving at moderate engine speeds. Steep accelerating and decelerating should be avoided.
- Always start the vehicle with your foot on the brake pedal. Do not depress the accelerator while starting the vehicle. Do not race the engine while warming it up.

Starting the diesel engine

To start the diesel engine when the engine is cold, it has to be pre-heated and then it has to be warmed up, before starting to drive.

1. Always carry the smart key with you.
2. Make sure the parking brake is applied.
3. Make sure the gear is shifted to P (Park) by pressing the P button.
4. Depress the brake pedal.
5. Press the Engine Start/Stop button.
6. Continue depressing the brake pedal until the glow indicator light () goes out.
7. When the glow indicator light () goes out, the engine will start.

Information

If the Engine Start/Stop button is pressed while the engine is pre-heating, the engine may start.

Starting and stopping the engine with turbocharger intercooler

1. Do not race or accelerate the engine immediately after starting the engine. If the engine is cold, idle for several seconds before sufficient lubrication is ensured in the turbocharger unit.
2. After high speed or extended driving that requires heavy engine load, idle the engine about 1 minute before turning the engine off. This idle time will allow the turbocharger to cool prior to shutting the engine off.

NOTICE

Do not turn off the engine immediately after it has been subjected to a heavy load. Doing so may cause severe damage to the engine or turbocharger unit.

NOTICE

To prevent damage to the vehicle:

- If the engine stalls while you are in motion, do not attempt to shift the gear to the P (Park) position.

If traffic and road conditions permit, you may put the gear in N (Neutral) while the vehicle is still moving and press the Engine Start/Stop button in an attempt to restart the engine.

- Do not push or tow your vehicle to start the vehicle.
-

NOTICE

To prevent damage to the vehicle:

Do not press the Engine Start/Stop button for more than 10 seconds except when the stop lamp fuse is blown.

When the stop lamp fuse is blown, you cannot normally start the engine. Replace the fuse with a new one. If you are not able to replace the fuse, you can start the engine by pressing and holding the Engine Start/Stop button for 10 seconds with the Engine Start/Stop button in the ACC position.

For your safety always depress the brake pedal before starting the vehicle.

Emergency starting



If the smart key battery is weak or the smart key does not work correctly, you can start the engine by pressing the Engine Start/Stop button with the smart key in the direction of the illustration above.

Turning off the engine

1. Stop the vehicle and depress the brake pedal fully.
2. Press the P button to shift to P (Park).
3. Press the Engine Start/Stop button to the OFF position and apply the parking brake.



Remote start

 if equipped



You can start the vehicle using the Remote Start button () of the smart key.

To start the vehicle remotely:

1. Press the door lock button within 10 m (32 ft.) from the vehicle.
 2. Press the remote start () button for over 2 seconds within 4 seconds after locking the doors. The hazard warning lights will blink.
 3. To turn off the remote start function, press the remote start () button once.
- The remote start () button may not operate if the smart key is not within 10 m (32 ft.).
 - The vehicle will not remotely start if the engine hood or trunk (or tailgate) is opened.
 - The vehicle must be in P (Park) for the remote start function to start.
 - The engine turns off if you get in the vehicle without a registered smart key.
 - The engine turns off if you do not get in the vehicle within 10 minutes after remotely starting the vehicle.
 - Do not idle the engine for a long period.

Automatic transmission



- [A] UNLOCK button
- [B] P button
- [C] Shift lever

When you move the shift lever, depress the brake pedal while pressing the UNLOCK button.

Automatic transmission operation

The automatic transmission has eight forward speeds and one reverse speed.

The individual speeds are selected automatically in the D (Drive) position.

WARNING

To reduce the risk of serious injury or death:

- Always check the surrounding areas near your vehicle for people, especially children, before shifting a vehicle into D (Drive) or R (Reverse).
- Before leaving the driver's seat, always make sure the vehicle is shifted to the P (Park) position, then apply the parking brake, then press the Engine Start/Stop button to the OFF position. Unexpected and sudden vehicle movement can occur if these precautions are not followed.
- When using the paddle shifter (manual shift mode), do not use engine braking (shifting from a high gear to lower gear) rapidly on slippery roads. The vehicle may slip causing an accident.

Transmission ranges

The indicator in the instrument cluster displays the gear position when the Engine Start/Stop button is in the ON position.

However, if the gear is in N (Neutral) or P (Park), the position appears on the instrument cluster when the Engine Start/Stop button is in the OFF or ACC position.

P (Park)

Always come to a complete stop before shifting into P (Park).



To shift the gear to P (Park), press the **P** button while depressing the brake pedal. If you turn the engine off in R (Reverse), N (Neutral) or D (Drive), the gear will automatically shift to P (Park).

WARNING

- Shifting into P (Park) while the vehicle is in motion may cause you to lose control of the vehicle.
- After the vehicle has stopped, always make sure the vehicle is in P (Park), apply the parking brake, and turn the engine off.
- When parking on an incline, shift the gear to P (Park) and apply the parking brake to prevent the vehicle from rolling downhill.

Automatic gear shift to P (Park)

The gear is shifted to P (Park) automatically for safety reasons under the following conditions:

- When the engine is turned off with the gear in R (Reverse), D (Drive) or N (Neutral).
- When the driver's door is opened with the gear in D (Drive) or R (Reverse) with the seat belt unfastened and the vehicle is at a standstill.
- When the driver's door is opened with the gear in N (Neutral) and the vehicle is turned off.

In situations the gear must be in P (Park), always check if the gear is shifted to P (Park) by checking the cluster.

R (Reverse)

Use this position to drive the vehicle rearward.

D (Drive) to R (Reverse)

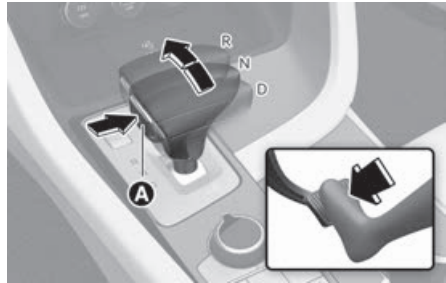

P (Park), N (Neutral) to R (Reverse)

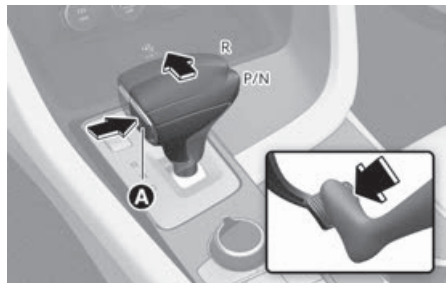

To move the shift lever to R (Reverse), press the **UNLOCK** button [A] while depressing the brake pedal and then move the shift lever forward.

NOTICE

Always come to a complete stop before shifting into or out of R (Reverse); you may damage the transmission if you shift into R (Reverse) while the vehicle is in motion.

N (Neutral)

The wheels and transmission are not engaged.

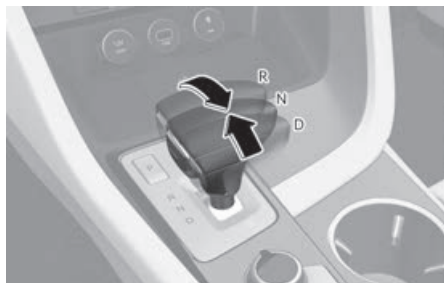

Use N (Neutral) if you need to restart a stalled engine.

Shift into P (Park) if you need to leave your vehicle for any reason.

Always depress the brake pedal when you are shifting from N (Neutral) to another gear.

In N (Neutral), if the driver attempts to turn off the engine, the transmission remains in the N (Neutral) position and the Engine Start/Stop button will be in the ACC position.

To turn off the engine from the ACC position, press the Engine Start/Stop button to the ON position, press the **P** button, and then press the Engine Start/Stop button to the OFF position.

When either the driver's door or the front passenger's door is opened with the Engine Start/Stop button in the ACC position and the shift lever in N (Neutral) position, the engine is automatically turned OFF and the transmission automatically changes to the P (Park) position.

⚠ WARNING

- Do not shift into gear unless your foot is firmly on the brake pedal. Use the P (Park) position to idle a vehicle for an extended period of time. The wheels and the transmission are not engaged. While parking the vehicle with the engine running, depress the brake pedal or apply the parking brake.
- Do not drive with the shift lever in N (Neutral). Doing so may result in an accident because of a loss of engine braking and the transmission could be damaged.
- The engine can be started with the gear in N (Neutral), but for your safety, be sure to start the engine with the gear in P (Park).

To stay in N (Neutral) when vehicle is OFF

If you want to stay in N (Neutral) after the engine is OFF (in the ACC state), do the following.

1. Turn off Auto Hold and release Electronic Parking Brake when the engine is running.
2. Depress the brake pedal, shift the gear to the P (Park) position, and turn off the engine.
3. Remove the cap-cover (1) and press the **P RELEASE** button (2) and shift the gear to the N (Neutral) position while depressing the brake pedal.



- The gear position is shifted to N (Neutral).
- You can only shift the gear between N (Neutral) and P (Park) within 20 seconds after turning off the engine.

! WARNING

- For safety, always put the gear in P (Park) and apply the parking brake when parking the vehicle unless necessary.
- Park the vehicle in N (Neutral) only on level ground. Vehicles moving on slopes can cause serious accidents.

D (Drive)

This is the normal driving position.

The transmission will automatically shift through an 8-gear sequence, providing the best fuel economy and power.

For extra power when passing another vehicle or driving uphill, depress the accelerator pedal further until you feel the transmission downshift to a lower gear.

R (Reverse) to D (Drive)

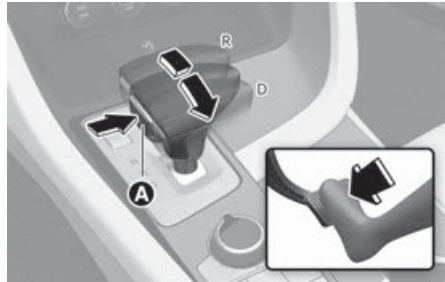

P (Park), N (Neutral) to D (Drive)

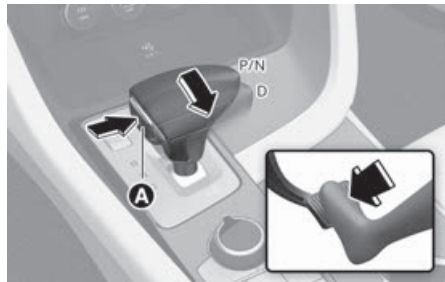

[A] UNLOCK Button

To shift into D (Drive), depress the brake pedal and press the **UNLOCK** button [A] on the shift lever. Move the shift lever rearward.

To shift into D (Drive) from N (Neutral), you must depress the brake pedal.

NOTICE

Always come to a complete stop before shifting into D (Drive).

! CAUTION

When you start after stopping on a steep incline, even if the gear is in D (Drive), if you do not depress the accelerator or brake pedal, the vehicle may roll backwards, which can cause an accident.

When the battery is discharged

You cannot shift gears, when the battery is discharged.

In emergencies, do the following to shift the gear to N (Neutral) on a level ground.

1. Connect the battery cables from another vehicle or from another battery to the jump-starting terminals inside the engine compartment.

For more information, refer to the “Jump starting” section in chapter 8.

2. Release the Electronic Parking Brake with the engine on.
3. Press the Engine Start/Stop button to the OFF position.
4. Remove the cap-cover (1) and press the **P RELEASE** button (2) while depressing the brake pedal.



Then, the gear will change to the N (Neutral) position. The button (2) operates only for 20 seconds to change the gear between P (Park) and N (Neutral) from the time when the button (2) is first pressed.

i Information

In situations when the gear needs to be shifted from P (Park) to N (Neutral) when the Engine Start/Stop button is in the OFF position, refer to the step 4.

Shift-lock system

For your safety, the automatic transmission has a shift-lock system which prevents shifting the transmission from P (Park) into R (Reverse) or D (Drive) unless the **UNLOCK** button is pressed while depressing the brake pedal.

To shift from P (Park) or N (Neutral) into R (Reverse) or D (Drive):

1. Depress and hold the brake pedal.
2. Start the engine or place the Engine Start/Stop button in the ON position.
3. Move the shift lever to R (Reverse) or D (Drive) while pressing the **UNLOCK** button.

Parking

Always come to a complete stop and continue to depress the brake pedal. Shift the gear to P (Park), apply the parking brake, and press the Engine Start/Stop button to the OFF position. Take the Key with you when leaving the vehicle.

⚠ WARNING

- When you stay in the vehicle with the engine running, be careful not to depress the accelerator pedal for a long period of time. The engine or exhaust system may overheat and start a fire.
- The exhaust gas and the exhaust system are very hot. Keep away from the exhaust system components.
- Do not stop or park over flammable materials, such as dry grass, paper or leaves. They may ignite and cause a fire.

Paddle shifter (Manual shift mode)

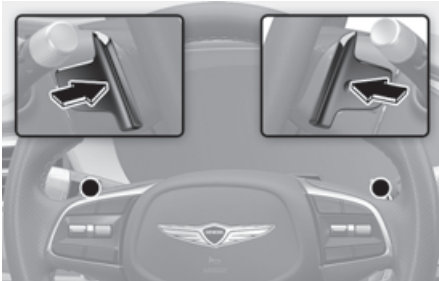

The paddle shifter allows the driver to shift gear without taking one's hands off the steering wheel.

The paddle shifter operates as follow.

- Pull the [+] or [-] paddle shifter once to shift up or down one gear and the system changes from automatic shift mode to manual shift mode.
- To change back to automatic shift mode from manual shift mode, do one of the following:
 - Pull the [+] paddle shifter for more than one second.
 - Drive the vehicle under 7 km/h (4 mph).
 - Gently depress the accelerator pedal for more than 6 seconds.
 - Rotate the shift dial to the D (Drive) position.

i Information

If the [+] and [-] paddle shifters are pulled at the same time, gear shift may not occur.

Cluster display messages (cluster)

Shifting system error

Type A

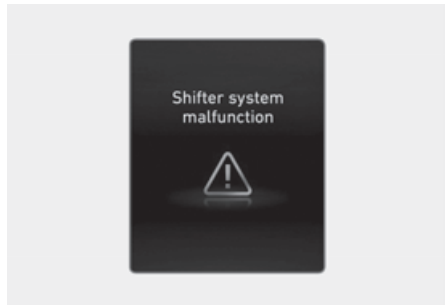

Type B

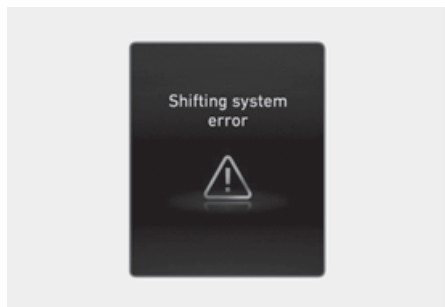

This message appears when the transmission or the shift button does not properly operate in the P (Park) position.

We recommend that you have the vehicle inspected by an authorized retailer of Genesis Branded products.

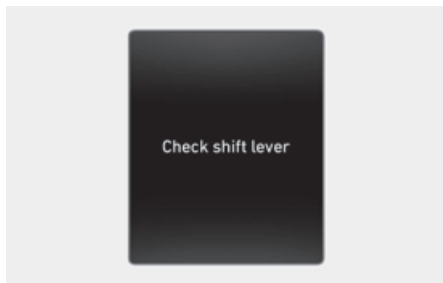
Check shift lever

The message appears on the cluster display when there is a malfunction with one of the key transmission shifter components.

We recommend that you immediately have the vehicle inspected by an authorized retailer of Genesis Branded products.

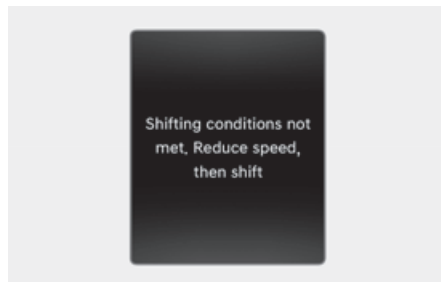
Shifting conditions not met. Reduce speed, then shift

This message appears when engine rpm is too high, or when driving speed is too fast to shift the gear.

Decrease vehicle speed or slow down before shifting the gear.

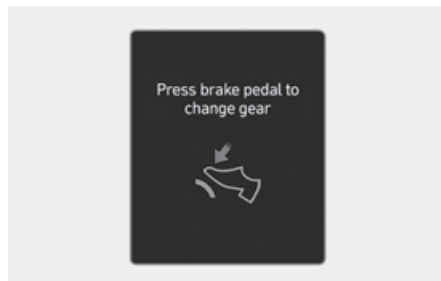
Press brake pedal to change gear

This message appears when the brake pedal is not depressed while shifting the gear.

Depress the brake pedal and then shift the gear.

Shift to P after stopping



This message appears when the gear is shifted to P (Park) while the vehicle is moving.

Stop the vehicle before shifting to P (Park).

Press P for Park/Press P to park

Type A

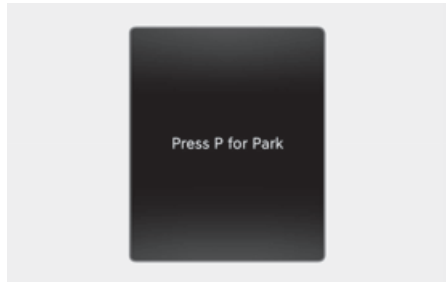

Type B

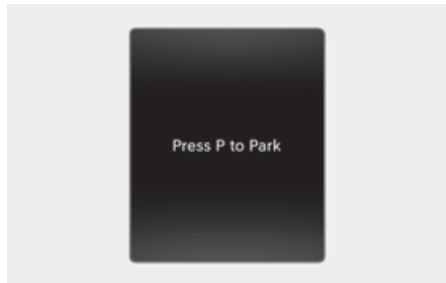

The message appears on the cluster display to inform the driver to press the **P** button to shift to P (Park) when the driver moves the shift lever upward even though the gear is in R (Reverse).

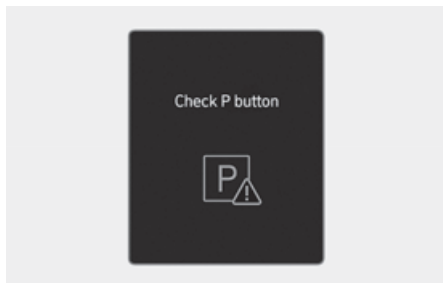
Check P button

This message appears when there is a problem with the **P** button. We recommend that you have the vehicle inspected by an authorized retailer of Genesis Branded products.

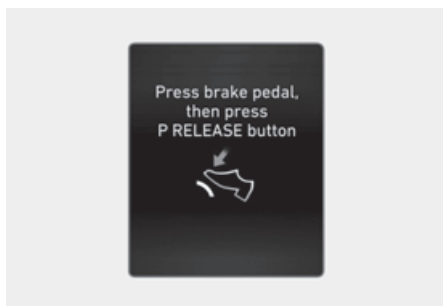
Press brake pedal, then press P RELEASE button

The message appears on the cluster display when the driver presses the **P RELEASE** button without depressing the brake pedal.

Depress the brake pedal before pressing the **P RELEASE** button.

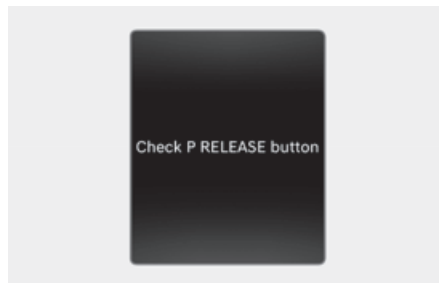
Check P RELEASE button

The message appears on the cluster display when there is problem with the **P RELEASE** button.

We recommend that you immediately have the vehicle inspected by an authorized retailer of Genesis Branded products.

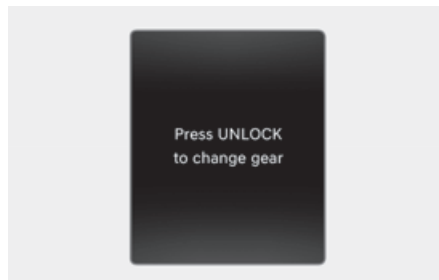
Press UNLOCK to change gear

The message appears on the cluster display when the **UNLOCK** button is not pressed while shifting the gear.

Press the **UNLOCK** button and then shift the gear.

Auto shift to P engaged

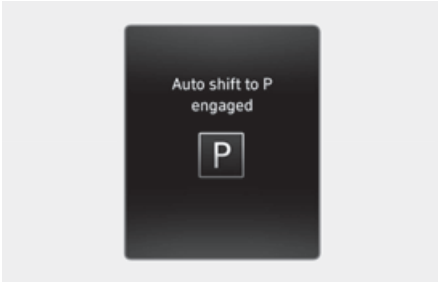

The message appears on the cluster display when the gear shifts to P (Park) automatically.

Example of gear shifting to P (Park) automatically:

When the driver's door is opened with the Engine Start/Stop button in the ACC position.

PARK engaged

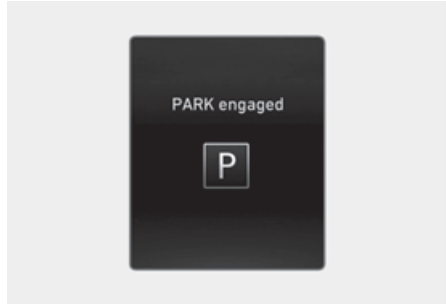

The message appears on the cluster display when the P (Park) position is engaged.

NEUTRAL engaged

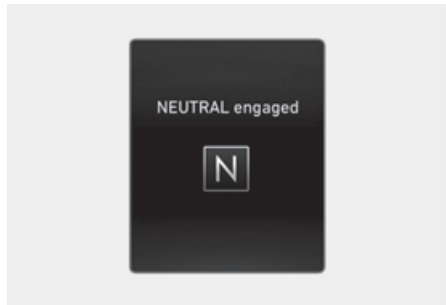

The message appears on the cluster display when the N (Neutral) position is engaged.

Transmission overheated warning

Transmission Hot! Park with engine on

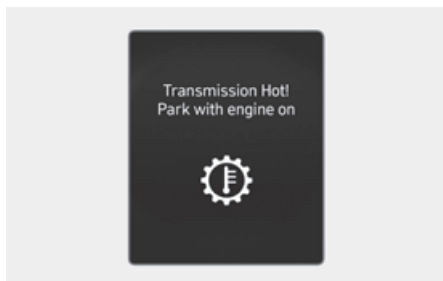

Repeated sudden acceleration and quick start may overheat the transmission. If the transmission is overheated, the self protection mode alarms the driver with an audible sound warning message.

Move the vehicle to a safe location and shift the gear to P (Park), and stop the vehicle with the engine on. Wait until the transmission is sufficiently cooled down.

Vehicle Power limited due to high transmission temperature

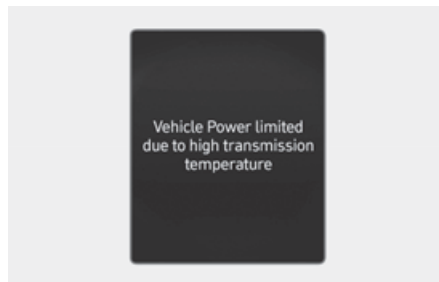

If you continue to drive with overheated transmission, the above warning message appears and self-protection mode restricts the power output of the vehicle.

- Move the vehicle to a safe location and shift the gear to P (Park), and stop the vehicle with the engine on. Wait until the transmission is sufficiently cooled down.
- If the above message is continuously displayed, we recommend that you have the vehicle inspected by an authorized retailer of Genesis Branded products.

Transmission cooled and safe to drive

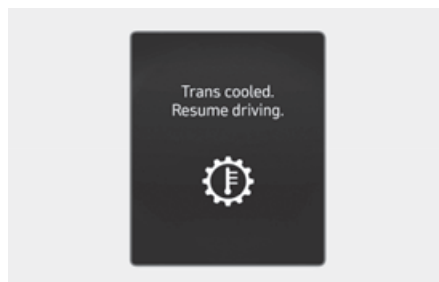

This message appears when the vehicle is safe to drive.

Good driving practices

- Never shift the gear from P (Park) or N (Neutral) to any other position with the accelerator pedal depressed.

- Never shift the gear into P (Park) when the vehicle is in motion.

Be sure the vehicle is completely stopped before you attempt to shift into R (Reverse) or D (Drive).

- Do not shift the gear to N (Neutral) when driving. If the gear is shifted to N (Neutral) while driving, the vehicle loses the ability to provide engine braking. Doing so may increase the risk of an accident.

Also, shift the gear back to D (Drive) while the vehicle is moving may severely damage the transmission.

- Driving uphill or downhill, always shift to D (Drive) when driving forward or to R (Reverse) when driving backwards, and check the gear position indicated on the cluster before driving. If you drive in the opposite direction of the selected gear, the engine will turn off and a serious accident might be occurred due to the degraded brake performance.

- When driving in sport mode, slow down before shifting to a lower gear. Otherwise, the lower gear may not be engaged if the engine RPMs are outside of the allowable range.
- Do not drive with your foot resting on the brake pedal. Even light, but consistent pedal pressure can result in the brakes overheating, brake wear and possibly even brake failure.
- Always apply the parking brake when leaving the vehicle. Do not depend on placing the transmission in P (Park) to keep the vehicle from moving.
- Exercise extreme caution when driving on a slippery surface. Be especially careful when braking, accelerating or shifting gears. On a slippery surface, an abrupt change in vehicle speed can cause the drive wheels to lose traction and may cause loss of vehicle control resulting in an accident
- Optimum vehicle performance and economy is obtained by smoothly depressing and releasing the accelerator.

⚠ WARNING

To reduce the risk of SERIOUS INJURY or DEATH:

- Always wear your seat belt. In a collision, an unbelted occupant is significantly more likely to be seriously injured or killed than a properly belted occupant.
- Avoid high speeds when cornering or turning.
- Do not make quick steering wheel movements, such as sharp lane changes or fast, sharp turns.
- The risk of rollover is greatly increased if you lose control of your vehicle at highway speeds.
- Loss of control often occurs if two or more wheels drop off the roadway and the driver over steers to reenter the roadway.
- In the event your vehicle leaves the roadway, do not steer sharply. Instead, slow down before pulling back into the travel lanes.
- Genesis Branded Vehicle recommends you to follow all posted speed limits.

NOTICE

Kickdown mechanism

Use the kickdown mechanism for maximum acceleration. Depress the accelerator pedal beyond the pressure point. The automatic transmission will shift to a lower gear depending on the engine speed.

Braking system**Power brakes**

Your vehicle has power-assisted brakes that adjust automatically through normal usage.

In the event of a vehicle power failure, the power assist for the brakes will not work. You can still stop your vehicle, but it will require greater force and increased pedal travel than normal. The stopping distance, however, will be longer than with power brakes.

When the engine is not running, the reserve brake power is partially depleted each time the brake pedal is applied. Do not pump the brake pedal when the power assist has been interrupted.

i Information

- When the brake pedal is depressed under certain driving conditions or weather conditions, you may temporarily hear a noise. This is normal and does not indicate a problem with your brakes.
- While driving on a road with deicing chemicals, brake noise or abnormal tire wear may occur due to deicing chemicals. In a safe traffic condition, additionally apply the brakes to remove deicing chemicals on the brake discs and pads.

 **WARNING**

Take the following precautions:

- Do not drive with your foot resting on the brake pedal. This will create abnormal high brake temperatures, excessive brake lining and pad wear, and increased stopping distances.
 - When descending down a long or steep hill, use the paddle shifter and manually downshift to a lower gear in order to control your speed without using the brake pedal excessively. Applying the brakes continuously will cause the brakes to overheat and could result in a temporary loss of braking performance.
 - Wet brakes may impair the vehicle's ability to safely slow down; the vehicle may also pull to one side when the brakes are applied. Applying the brakes lightly will indicate whether they have been affected in this way. Always test your brakes in this fashion after driving through deep water. To dry the brakes, lightly tap the brake pedal to heat up the brakes while maintaining a safe forward speed until brake performance returns to normal. Avoid driving at high speeds until the brakes function correctly.
-

High Performance Brake

 If equipped

For vehicles equipped with the High Performance Brake (large-diameter Brembo brakes for enhanced braking performance), noise such as a squeal, squeak or groan is generated while braking. This is normal and the friction may create circle patterns on the disc surface. This is also a normal situation which does not affect braking performance.

NOTICE

- Occasional brake noise is normal. If a continuous grinding or continuous squeal sound is present, the brake lining may be worn-out. Have the vehicle checked by an authorized retailer of Genesis Branded products.
 - If the vehicle has continuous vibration or shudder in the steering wheel while braking, have the vehicle be checked by an authorized retailer of Genesis Branded products.
-

 **WARNING**

Frequent speeding and braking may deform components and worn the disc brake causing vibration when braking. Prevent brake damage by avoiding excessive braking.

Brake wear, noise, vibration from excessive braking or deformation of the brakes caused by repeatedly braking in high speed, racing on tracks, etc. can be excluded from warranty coverage.

Disc brakes wear indicator

When your brake pads are worn and new pads are required, you will hear a high pitched warning sound from your front or rear brakes. You may hear this sound come and go or it may occur whenever you depress the brake pedal.

NOTICE

To avoid costly brake repairs, do not continue to drive with worn brake pads.

i Information

Always replace brake pads as complete front or rear axle sets.

Electronic Parking Brake (EPB)

Applying the parking brake



To apply EPB (Electronic Parking Brake):

1. Depress and hold the brake pedal.
2. Pull up the EPB switch.

Make sure the Parking Brake warning light comes on.

EPB (Electronic Parking Brake) may be automatically applied when:

- Requested by other systems
- The driver turns the vehicle off while Auto Hold is operating.

Emergency braking

If there is a problem with the brake pedal while driving, emergency braking is possible by pulling up and holding the EPB switch. Braking is possible only while you are holding the EPB switch. However, braking distance will be longer than normal.

WARNING

To reduce the risk of **SERIOUS INJURY** or **DEATH**, do not operate the EPB while the vehicle is moving except in an emergency situation. It could damage the brake system and lead to an accident.

Information

During emergency braking, the Parking Brake warning light will illuminate to indicate that the system is operating.

NOTICE

If you continuously notice a noise or burning smell when the EPB is used for emergency braking, we recommend that you have the system checked by an authorized retailer of Genesis Branded products.

Releasing the parking brake

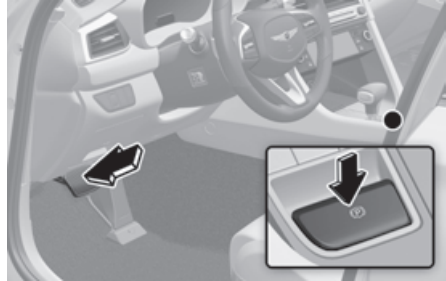

To release EPB (Electronic Parking Brake):

1. Press the Engine Start/Stop button to the ON or START position.
2. Press the EPB switch while depressing the brake pedal.

Make sure the Parking Brake warning light goes off.

To release EPB (Electronic Parking Brake) automatically:

- Gear in P (Park)
With the engine running depress the brake pedal and shift out of P (Park) to R (Reverse) or D (Drive).
- Gear in N (Neutral)
With the engine running depress the brake pedal and shift out of N (Neutral) to R (Reverse) or D (Drive).

- Satisfy the following conditions
 1. Ensure seat belts are fastened and the doors, hood and trunk (or tailgate) are closed.
 2. With the engine running, depress the brake pedal and shift out of P (Park) to R (Reverse), D (Drive) or Manual shift mode.
 3. Depress the accelerator pedal.
Make sure the Parking Brake warning light goes off.

i Information

- For the Middle East , EPB is released regardless of seat belt fastening.
- You can engage EPB even though the Engine Stop/Start button is in the OFF position (only if battery power is available), but you cannot release it.
- Depress the brake pedal and release the parking brake manually with the EPB switch before you drive downhill or when backing up.

NOTICE

- If the Parking Brake warning light is still on even though the EPB has been released, we recommend that you have the system checked by an authorized retailer of Genesis Branded products.
- Do not drive your vehicle with EPB applied. It may cause excessive brake pad and brake rotor wear.

Warning messages

Type A

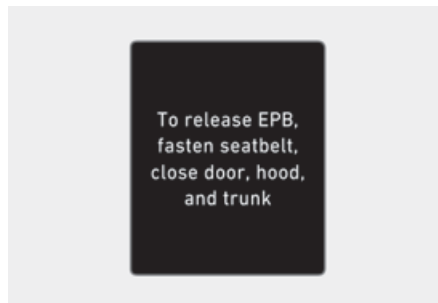

Type B

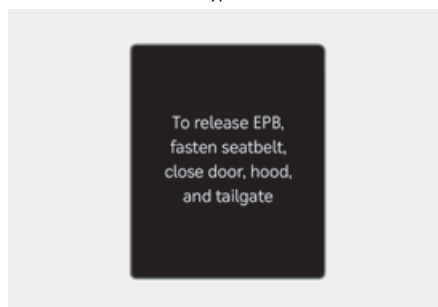

To release EPB, fasten seatbelt, close door, hood and trunk (or tailgate)

If the driver's seat belt is unfastened, or the hood, trunk (or tailgate), doors are open, and you try to drive with EPB applied, a warning sounds and a message appears.

 **WARNING**

- Whenever leaving the vehicle or parking, always come to a complete stop and continue to depress the brake pedal.

Shift the gear into P (Park), pull the EPB switch, and to turn the vehicle off. Take the Key with you when leaving the vehicle.

Vehicles not fully engaged in P (Park) with the parking brake set are at risk for moving inadvertently and causing injury to yourself or others.

- Never allow anyone who is unfamiliar with the vehicle to touch the EPB switch. If EPB is released unintentionally, serious injury may occur.
 - Only release EPB when you are seated inside the vehicle with your foot firmly on the brake pedal.
-

NOTICE

- Do not apply the accelerator pedal while the parking brake is engaged. If you depress the accelerator pedal with EPB engaged, a warning will sound and a message will appear. Damage to the parking brake may occur.
 - Driving with the parking brake on can overheat the braking system and cause premature wear or damage to brake parts. Make sure EPB is released and the Parking Brake warning light is off before driving.
-

 **Information**

- A clicking sound may be heard while operating or releasing the EPB. These conditions are normal and indicate that EPB is functioning properly.
 - When leaving your keys with a parking attendant or assistant, be sure to inform him/her how to operate the EPB.
-

AUTO HOLD turning Off! Press brake pedal/Turning off AUTO HOLD. Press brake pedal

Type A

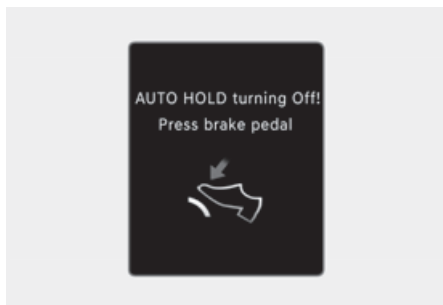

Type B

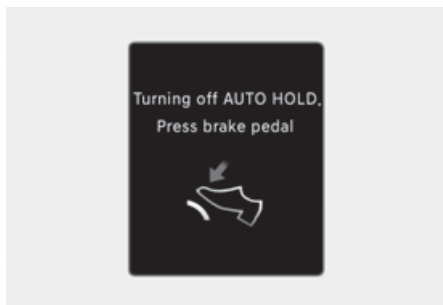

When the conversion from Auto Hold to EPB is not working properly a warning will sound and a message will appear.

Parking brake automatically engaged/Parking brake automatically applied

Type A

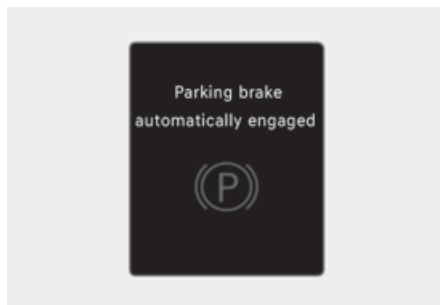

Type B

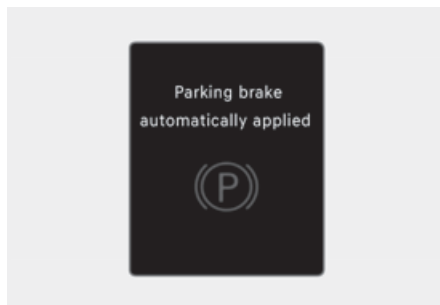

When EPB is applied while Auto Hold is activated, a warning will sound and a message will appear.

EPB malfunction

Electronic Parking Brake (EPB) warning light illuminates if the Engine Start/Stop button is pressed to the ON position and goes off in about 3 seconds if the system is operating normally.

If the EPB warning light remains on, comes on while driving, or does not come on when the Engine Start/Stop button is pressed to the ON position, this indicates that the EPB may have malfunctioned.

If this occurs, we recommend that you have the system checked by an authorized retailer of Genesis Branded products.

The EPB warning light may illuminate when the ESC indicator comes on to indicate that ESC is not working properly, but it does not indicate a malfunction of EPB.

NOTICE

- If the Parking Brake warning light does not illuminate or blinks after the EPB switch has been pulled, the EPB may not be applied.
- If the EPB warning light is still on or the Parking Brake warning light blinks when the EPB warning light is on, press the switch, and then pull it up. Repeat this one more time. If the EPB warning does not go off, we recommend that you have the system checked by an authorized retailer of Genesis Branded products.

Parking brake warning light



Check the Parking Brake warning light by pressing the Engine Stop/Start button to the ON position.

This light will be illuminated when the parking brake is applied with the Engine Stop/Start button in the START or ON position.

Before driving, be sure the parking brake is released and the Parking Brake warning light is OFF.

If the Parking Brake warning light remains on after the parking brake is released while the engine is running, there may be a malfunction in the brake system. Immediate attention is necessary.

If at all possible, cease driving the vehicle immediately. If that is not possible, use extreme caution while operating the vehicle and only continue to drive the vehicle until you can reach a safe location.

When the EPB (Electronic Parking Brake) does not release

If the EPB does not release normally, we recommend that you contact an authorized retailer of Genesis Branded products by loading the vehicle on a flatbed tow truck and have the system checked.

Auto Hold

Auto Hold maintains the vehicle in a standstill even though the brake pedal is not depressed after the driver brings the vehicle to a complete stop by depressing the brake pedal.

i Information

The Auto Hold On or Off setting is maintained when the vehicle is turned off. When the vehicle is restarted the last setting for Auto Hold is applied.

To apply:

1. With the driver's door and engine hood closed, depress the brake pedal and then press the AUTO HOLD switch. The white AUTO HOLD indicator will come on and the system will be in the standby position.



[A] White

2. When you stop the vehicle completely by depressing the brake pedal, Auto Hold maintains the brake pressure to hold the vehicle stationary. The indicator changes from white to green.

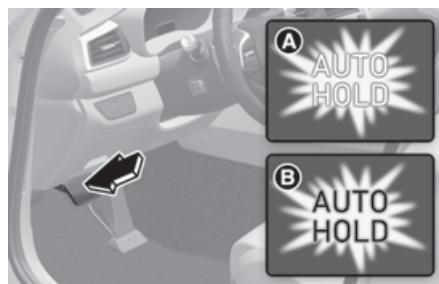

[A] White
[B] Green

3. The vehicle will remain stationary even if you release the brake pedal.
4. If EPB is applied, Auto Hold will be released.

To release:

If you depress the accelerator pedal with the gear in D (Drive) or Manual shift mode, the Auto Hold will be released automatically and the vehicle will start to move. The AUTO HOLD indicator changes from green to white.

⚠ WARNING

Always look around your vehicle before depressing the accelerator pedal to release Auto Hold.

To cancel:



[A] Light off

1. Depress and hold the brake pedal.
2. Press the AUTO HOLD switch.

The AUTO HOLD indicator will turn off.

⚠ WARNING

To prevent unintended vehicle movement, always depress your foot on the brake pedal to cancel the Auto Hold before you:

- Drive downhill.
 - Park the vehicle.
-

i Information

- The Auto Hold does not operate when:
 - The driver's door is opened
 - The engine hood is opened
 - The gear is in P (Park)
 - The gear is in R (Reverse)
 - EPB is applied
 - For your safety, the Auto Hold automatically switches to EPB when:
 - The driver's door is opened
 - The engine hood is opened
 - The vehicle is in a standstill for a long time.
 - The vehicle is standing on a steep slope
 - The vehicle moved several timesThe Parking Brake warning light comes on, the AUTO HOLD indicator changes from green to white, and a warning sounds and a message appears to inform you that EPB has been automatically engaged. Before driving, depress the brake pedal, check the surrounding area and release the parking brake manually with the EPB switch.
 - While operating Auto Hold, you may hear mechanical noise. However, it is normal operating noise.
-

NOTICE

If the AUTO HOLD indicator changes to yellow, Auto Hold is not working properly. We recommend that you contact an authorized retailer of Genesis Branded products.

⚠ WARNING

- Depress the accelerator pedal slowly when you start the vehicle.
 - For your safety, cancel Auto Hold when you drive downhill, back up the vehicle or park the vehicle.
-

NOTICE

If there is a malfunction with the driver's door or engine hood open detection system, Auto Hold may not work properly. We recommend that you contact an authorized retailer of Genesis Branded products.

Warning messages**Parking brake automatically engaged/Parking brake automatically applied**

Type A

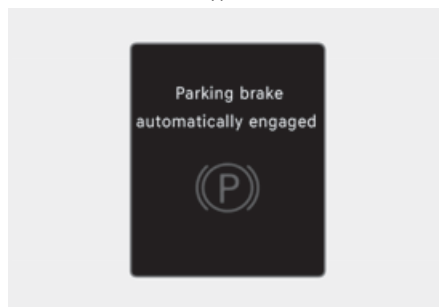

Type B

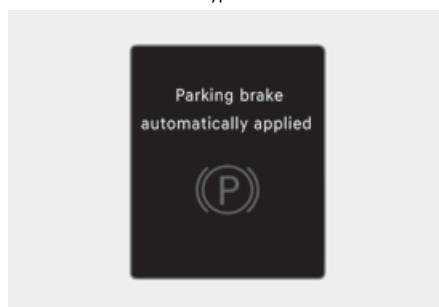

When EPB is applied while Auto Hold is activated, a warning will sound and a message will appear.

AUTO HOLD turning Off! Press brake pedal/Turning off AUTO HOLD. Press brake pedal

Type A

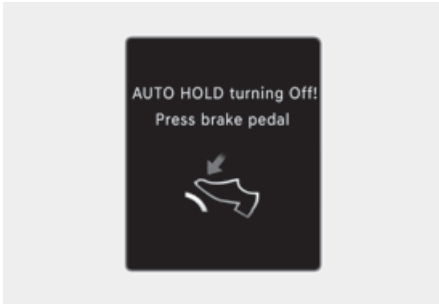

Type B

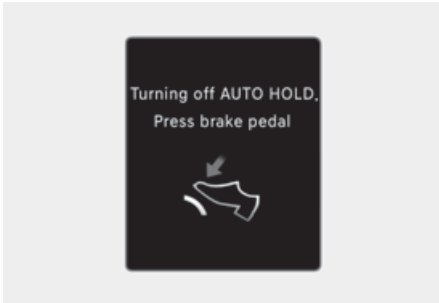

When the conversion from Auto Hold to EPB is not working properly a warning will sound and a message will appear.

When this message appears, Auto Hold and EPB may not operate. For your safety, depress the brake pedal.

Press brake pedal to deactivate AUTO HOLD

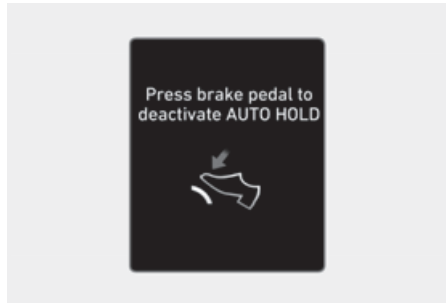

If you did not apply the brake pedal when you release Auto Hold by pressing the AUTO HOLD switch, a warning will sound and a message will appear.

AUTO HOLD conditions not met. Close door and hood.

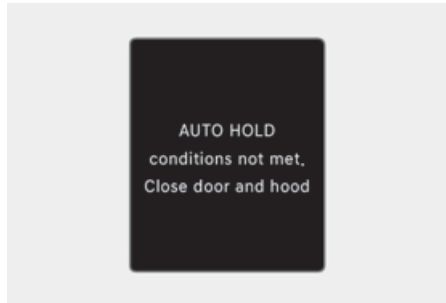

When you press the AUTO HOLD switch, if the driver's door and engine hood are not closed, a warning will sound and a message will appear on the cluster display.

Press the AUTO HOLD switch after closing the driver's door and hood.

Anti-lock Brake System (ABS)

WARNING

Anti-Lock Braking System (ABS) or Electronic Stability Control (ESC) system will not prevent accidents due to improper or dangerous driving maneuvers. Even though vehicle control is improved during emergency braking, always maintain a safe distance between you and objects ahead of you. Vehicle speeds should always be reduced during extreme road conditions. The braking distance for vehicles equipped with ABS or ESC may be longer than for those without these systems in the following road conditions.

Drive your vehicle at reduced speeds during the following conditions:

- Rough, gravel or snow-covered roads.
- On roads where the road surface is pitted or has different surface height.
- Tire chains are installed on your vehicle.

The safety features of ABS or ESC equipped vehicle should not be tested by high speed driving or cornering. This could endanger the safety of yourself or others.

ABS is an electronic braking system that helps prevent a braking skid. ABS allows the driver to steer and brake at the same time.

Using ABS

To obtain the maximum benefit from your ABS in an emergency situation, do not attempt to modulate your brake pressure and do not try to pump your brakes. Depress your brake pedal as hard as possible.

When you apply your brakes under conditions which may lock the wheels, you may hear sounds from the brakes, or feel a corresponding sensation in the brake pedal. This is normal and it means your ABS is active.

ABS does not reduce the time or distance it takes to stop the vehicle.

Always maintain a safe distance from the vehicle in front of you.

ABS will not prevent a skid that results from sudden changes in direction, such as trying to take a corner too fast or making a sudden lane change. Always drive at a safe speed for the road and weather conditions.

ABS cannot prevent a loss of stability. Always steer moderately when braking hard. Severe or sharp steering wheel movement can still cause your vehicle to veer into oncoming traffic or off the road.

On loose or uneven road surfaces, operation of the anti-lock brake system may result in a longer stopping distance than for vehicles equipped with a conventional brake system.

The ABS  warning light will stay on for several seconds after the Engine Start/Stop button is in the ON position.

During that time, ABS will go through self-diagnosis and the light will go off if everything is normal. If the light stays on, you may have a problem with your ABS. We recommend that you contact an authorized retailer of Genesis Branded products as soon as possible.

⚠ WARNING

If the ABS (🚗) warning light is on and stays on, you may have a problem with the ABS. Your power brakes will work normally. To reduce the risk of serious injury or death, we recommend that you contact your authorized retailer of Genesis Branded products as soon as possible.

NOTICE

When you drive on a road having poor traction, such as an icy road, and apply your brakes continuously, ABS will be active continuously and the ABS (🚗) warning light may illuminate. Pull your vehicle over to a safe place and turn the vehicle off.

Restart the vehicle. If the ABS warning light is off, then your ABS system is normal.

Otherwise, you may have a problem with your ABS system. We recommend that you contact an authorized retailer of Genesis Branded products as soon as possible.

***i* Information**

When you jump start your vehicle because of a drained battery, the ABS (🚗) warning light may turn on at the same time. This happens because of the low battery voltage. It does not mean your ABS is malfunctioning. Have the battery recharged before driving the vehicle.

Electronic Stability Control (ESC)



Electronic Stability Control helps to stabilize the vehicle during cornering maneuvers.

ESC checks where you are steering and where the vehicle is actually going. ESC applies braking pressure to any one of the vehicle's brakes and intervenes in the engine management system to assist the driver with keeping the vehicle on the intended path. It is not a substitute for safe driving practices. Always adjust your speed and driving to the road conditions.

⚠ WARNING

Never drive too fast for the road conditions when cornering. ESC will not prevent accidents.

Excessive speed in turns, abrupt maneuvers, and hydroplaning on wet surfaces can result in severe accidents.

ESC operation

ESC ON condition

When the Engine Start/Stop button is in the ON position, ESC and the ESC OFF indicator lights illuminate for about three seconds. After both lights go off, ESC is enabled.

When operating



When ESC is in operation, the ESC indicator light blinks:

- When you apply your brakes under conditions which may lock the wheels, you may hear sounds from the brakes, or feel a corresponding sensation in the brake pedal. This is normal and it means your ESC is active.
- When ESC activates, the engine may not respond to the accelerator as it does under routine conditions.
- If Cruise Control was in use when ESC activates, Cruise Control automatically disengages. Cruise Control can be reengaged when the road conditions allow. refer to the "Cruise Control (CC)" section in chapter 7 (if equipped).
- When moving out of the mud or driving on a slippery road, the engine RPM (revolutions per minute) may not increase even if you press the accelerator pedal deeply. This is to maintain the stability and traction of the vehicle and does not indicate a problem.

ESC OFF condition



To cancel ESC operation:

- State 1

Press the ESC OFF button briefly. The ESC OFF indicator light and/or message "**Traction Control disabled**" will illuminate. In this state, the traction control function of ESC (engine management) is disabled, but the brake control function of ESC (braking management) still operates.

ESC OFF state 1 will be automatically selected and illuminate on the cluster when SPORT+ mode is selected while Drive mode is operating.

- State 2

Press and hold the ESC OFF button continuously for more than 3 seconds. The ESC OFF indicator light and/or message "**Traction & Stability Control disabled**" illuminates. In this state, both the traction control function of ESC (engine management) and the brake control function of ESC (braking management) are disabled.

If the Engine Start/Stop button is pressed to the OFF position when ESC is off, ESC remains off. Upon restarting the vehicle, ESC will automatically turn on again.

Indicator lights

ESC indicator light (blinks)



ESC OFF indicator light (comes on)



When the Engine Start/Stop button is pressed to the ON position, the ESC indicator light illuminates, then goes off if the ESC system is operating normally.

The ESC indicator light blinks whenever ESC is operating.

If the ESC indicator light stays on, your vehicle may have a malfunction with the ESC system. When this warning light illuminates we recommend that the vehicle be checked by an authorized retailer of Genesis Branded products as soon as possible.

The ESC OFF indicator light comes on when ESC is turned off.

WARNING

When ESC is blinking, this indicates ESC is active:

Drive slowly and Never attempt to accelerate. Never turn ESC off while the ESC indicator light is blinking or you may lose control of the vehicle resulting in an accident.

NOTICE

Driving with wheels and tires with different sizes may cause the ESC system to malfunction. Before replacing tires, make sure all four tires and wheels are the same size. Never drive the vehicle with different sized wheels and tires installed.

ESC OFF usage

When Driving

The ESC OFF mode should only be used briefly to help free the vehicle if stuck in snow or mud, by temporarily stopping operation of ESC, to maintain wheel torque.

To turn ESC off while driving, press the ESC OFF button while driving on a flat road surface.

NOTICE

To prevent damage to the transmission:

- Do not allow wheel(s) of one axle to spin excessively while the ESC, ABS, and Parking Brake warning lights appear. The repairs would not be covered by the vehicle warranty. Reduce engine power and do not spin the wheel(s) excessively while these lights appear.
 - When operating the vehicle on a dynamometer, make sure ESC is turned off (ESC OFF light illuminated).
-

***i* Information**

Turning ESC off does not affect ABS or standard brake system operation.

Vehicle Stability Management (VSM)

Vehicle Stability Management is a function of the Electronic Stability Control (ESC) system. It helps the vehicle stay stable when accelerating or braking suddenly on wet, slippery and rough roads where traction over the four tires can suddenly become uneven.

WARNING

Take the following precautions when using Vehicle Stability Management:

- Always check the speed and the distance to the vehicle ahead. VSM is not a substitute for safe driving practices.
- Never drive too fast for the road conditions. VSM will not prevent accidents. Excessive speed in bad weather, on slippery and uneven roads can result in severe accidents.

VSM operation

When operating

When you apply your brakes under conditions which may activate ESC, you may hear sounds from the brakes, or feel a corresponding sensation in the brake pedal. This is normal and it means your VSM is active.

Information

VSM does not operate when:



- Driving on a banked road such as gradient or incline.
- Driving in reverse.
- The ESC OFF indicator light is on.
- The MDPS (Motor Driven Power Steering) warning light () is on or blinks.

VSM OFF condition

To cancel VSM operation, press the ESC OFF button. ESC OFF () indicator light will illuminate.

To turn on VSM, press the ESC OFF button again. The ESC OFF indicator light will go out.

WARNING

If the ESC () indicator light or MDPS () warning light stays illuminated or blinks, your vehicle may have a malfunction with the VSM system. When the warning light illuminates we recommend that the vehicle be checked by an authorized retailer of Genesis Branded products as soon as possible.

NOTICE

Driving with wheels and tires with different sizes may cause the VSM system to malfunction. Before replacing tires, make sure all four tires and wheels are the same size. Never drive the vehicle with different sized tires and wheels installed.

Hill-Start Assist Control (HAC)

Hill-Start Assist Control helps prevent the vehicle from rolling backwards when starting a vehicle from a stop on a hill. The system operates the brakes automatically for about 5 seconds and releases the brake after 5 seconds or when the accelerator pedal is depressed.

WARNING

Always be ready to depress the accelerator pedal when starting off an incline. Hill-Start Assist Control activates only for about 5 seconds.

i Information

- Hill-Start Assist Control does not operate when the gear is shifted to P (Park) or N (Neutral).
 - Hill-Start Assist Control activates even when the ESC (Electronic Stability Control) is off. However, it does not activate, when ESC does not operate normally.
-

Emergency Stop Signal (ESS)

 If equipped

Emergency Stop Signal alerts the driver behind by blinking the stop lights, while sharply and severely braking.

The system is activated when:

- The vehicle suddenly stops. (The deceleration power exceeds 7 m/s^2 and the driving speed exceeds 55 km/h (34 mph).)
- ABS is activated.

The hazard warning flasher automatically turns ON after blinking the stop lights:

- When driving speed is under 40 km/h (25 mph),
- When ABS is deactivated, and
- When the sudden braking situation is over.

The hazard warning flasher turns OFF:

- When the vehicle drives at a low speed for a certain period of time.

The driver can manually turn OFF the hazard warning flasher by pressing the button.

i Information

Emergency Stop Signal will not activate, when the hazard warning flashers are already on.

Multi-Collision Brake (MCB)

 if equipped

Multi-Collision Brake controls the brake automatically in the event of an accident where the airbag deploys to reduce the risk of additional accidents that may occur.

System operation

- From the time the airbag deploys, Multi-Collision Brake monitors the depression intensity of the brake pedal and accelerator pedal for a short period. The system operates when the following conditions are met:
 - Vehicle speed is under 180 km/h (112 mph) at the time of collision.
 - The brake pedal and accelerator pedal are hardly depressed.
- When the driver steps on the brake pedal over a certain level while Multi-Collision Brake is active, the braking power takes priority over automatic braking by Multi-Collision Brake system. However, if the driver takes his/her foot off the brake pedal, automatic braking by Multi-Collision Brake system will maintain automatic braking.

System off

Multi-Collision Brake is canceled in the following situations:

- The accelerator pedal is depressed over a certain level.
- The vehicle stops.
- ESC (Electronic Stability Control) or electronic devices has malfunctioned.
- In a situation system cannot operate normally.
- Ten seconds have passed since the brake has been controlled automatically by Multi-Collision Brake system.

WARNING

- Multi-Collision Brake decreases vehicle speed after a collision and reduces the risk of a second collision, but it does not prevent a second collision. You may drive away from the collision spot to avoid other dangerous situations by depressing the accelerator pedal.
- After the vehicle is stopped by Multi-Collision Brake, the system stops controlling the brakes. Depending on the situation, the driver should depress the brake or the accelerator pedal to prevent further accidents.

Brake Assistant System (BAS)

The Brake Assistant System provides additional pressure when the brake pedal is momentarily and strongly depressed in a situation sudden braking is required while driving.

The Brake Assistant System reduces the time for ABS (Anti-Lock Brake System) control to enter and consequently reduces the braking distance, by providing additional pressure up to the point of ABS intervention.

System operation

- When the vehicle speed is more than 30 km/h (19 mph) and the ABS control is not entered.
- When the brake pedal is depressed strongly over a certain level.
- When the friction of the road surface is above a certain level.

System operation off

- The vehicle speed is below 10 km/h (6 mph).
- The brake pedal is depressed over a certain conditions.
- The friction of the road surface is below a certain level.

WARNING

The system may not operate depending on driver's driving habit, the degree to which the brake pedal is depressed and the road surface condition.

Good braking practices

WARNING

Whenever leaving the vehicle or parking, always come to a complete stop and continue to depress the brake pedal. Shift the gear to the P (Park) position, then apply the parking brake, and press the Engine Start/Stop button to the OFF position.

Vehicles parked with the parking brake not applied or not fully engaged may roll inadvertently and may cause injury to the driver and others. Always apply the parking brake before exiting the vehicle.

Wet brakes can be dangerous! The brakes may get wet if the vehicle is driven through standing water or if it is washed. Your vehicle will not stop as quickly if the brakes are wet. Wet brakes may cause the vehicle to pull to one side.

To dry the brakes, apply the brakes lightly until the braking action returns to normal. If the braking action does not return to normal, stop as soon as it is safe to do so and we recommend that you call an authorized retailer of Genesis Branded products for assistance.

DO NOT drive with your foot resting on the brake pedal. Even light, but constant pedal pressure can result in the brakes overheating, brake wear, and possibly even brake failure.

If a tire goes flat while you are driving, apply the brakes gently and keep the vehicle pointed straight ahead while you slow down. When you are moving slowly enough for it to be safe to do so, pull off the road and stop in a safe location.

Keep your foot firmly on the brake pedal when the vehicle is stopped to prevent the vehicle from rolling forward.

All Wheel Drive (AWD)

 if equipped

All Wheel Drive (AWD) delivers engine power to front and rear wheels for maximum traction. AWD is useful when extra traction is required, such as when driving on, muddy, wet, or snow-covered roads.

WARNING

If the AWD () warning light stays on the instrument cluster, your vehicle may have a malfunction with the AWD system. When the AWD () warning light illuminates we recommend that the vehicle be checked by an authorized retailer of Genesis Branded products as soon as possible.

WARNING

To reduce the risk of SERIOUS INJURY or DEATH:

- Do not drive in conditions that exceed the vehicles intended design such as challenging off-road conditions.
- Avoid high speeds when cornering or turning.
- Do not make quick steering wheel movements, such as sharp lane changes or fast, sharp turns.
- The risk of a rollover is greatly increased if you lose control of your vehicle at highway speeds.
- Loss of control often occurs if two or more wheels drop off the roadway and the driver over steers to reenter the roadway.
- In the event your vehicle leaves the roadway, do not steer sharply. Instead, slow down before pulling back into the travel lanes.

NOTICE

- Do not drive in water if the water level is higher than the bottom of the vehicle.
- Check your brake condition once you are out of mud or water. Depress the brake pedal several times as you move slowly until you feel normal braking condition is returned.
- Shorten your scheduled maintenance interval if you drive in off-road conditions such as sand, mud or water (refer to the “Maintenance under severe usage conditions (for Europe, except Russia)” section in chapter 9).
- Always wash your vehicle thoroughly after off road use, especially the bottom of the vehicle.
- Be sure to equip the vehicle with four tires of the same size and type.
- Make sure that a full time AWD vehicle is towed by a flat bed tow truck.

All Wheel Drive (AWD) operation

Auto AWD mode (Normal driving)

If the AWD system determines there is a need for four wheel drive, the engine's driving power is distributed to all four wheels automatically.

For safe AWD operation

Before driving

- Make sure all passengers are wearing seat belts.
- Sit upright and closer to the steering wheel than usual. Adjust the steering wheel to a position comfortable for you to drive.

Driving on snow-covered or icy roads

- Start off slowly by applying the accelerator pedal gently.
- Use snow tires or tire chains.
- Keep sufficient distance between your vehicle and the vehicle in front of you.
- Apply engine braking during deceleration by using the paddle shifter (manual shift mode) and manually selecting a lower gear.
- Avoid speeding, rapid acceleration, sudden brake applications, and sharp turns to prevent skids.

***i* Information**

- When using Snow Tires, mount them on all four wheels.
- When using tire chains, install them on the rear tires. However, driving speed must be below 30 km/h (20 mph) and minimize the driving distance. High-speed or long-term driving with the chains installed may malfunction or damage the AWD system.
- If tire chains must be used, use AutoSock (fabric snow chain) and install the tire chain after reviewing the instructions provided with the tire chains.
For more information on Snow Tires and Tire Chains, refer to the "Winter driving" in this chapter.

Driving in sand or mud

- Maintain slow and constant speed.
- Use tire chains driving in mud if necessary.
- Keep sufficient distance between your vehicle and the vehicle in front of you.
- Reduce vehicle speed and always check the road condition.
- Avoid speeding, rapid acceleration, sudden brake applications, and sharp turns to prevent getting stuck.

NOTICE

When the vehicle is stuck in snow, sand or mud, place a nonslip material under the drive wheels to provide traction OR slowly spin the wheels in forward and reverse directions which causes a rocking motion that may free the vehicle.

However, avoid running the engine continuously at high rpm, doing so may damage the AWD system.

Driving up or down hills

- Driving uphill
 - Before starting off, check if it is possible to drive uphill.
 - Drive as straight as possible.
- Driving downhill
 - Do not change gear while driving downhill. Select gear before driving downhill.
 - Drive slowly using engine braking while driving downhill.
 - Drive straight as possible.

WARNING

Exercise extreme caution driving up or down steep hills. The vehicle may flip over depending on the grade, terrain, water and mud conditions.

WARNING

Do not drive across the contour of steep hills. A slight change in the wheel angle can destabilize the vehicle, or a stable vehicle may lose stability if the vehicle stops its forward motion. Your vehicle may roll over and lead to a serious injury or death.

Emergency precautions

Tires

When replacing tires, be sure to equip all four tires with the same size, type, tread pattern, brand and load-carrying capacity.

WARNING

Do not use tire and wheel with different size and type from the one originally installed on your vehicle. It can affect the safety and performance of your vehicle, which could lead to steering failure or rollover causing serious injury.

In an emergency situation, a compact spare tire and tire mobility kit (if equipped) may be used. But, do not use the compact spare tire continuously. Repair or replace the original tire as soon as possible to avoid failure of the differential or AWD system.



Never start or run the engine while an AWD vehicle is raised on a jack. The vehicle can slip or roll off of a jack causing serious injury or death to you or those nearby.

Towing

AWD vehicles must be towed with a wheel lift and dollies or flatbed equipment with all the wheels off the ground. For more information, refer to the "Towing" section in chapter 8.

Vehicle inspection

- If the vehicle needs to be operated on a vehicle lift do not attempt to stop any of the four wheels from turning. This could damage the AWD system.
- Never engage the parking brake while running the engine on a car lift. This may damage the AWD system.

Dynamometer testing

An AWD vehicle must be tested on a special four wheel chassis dynamometer.

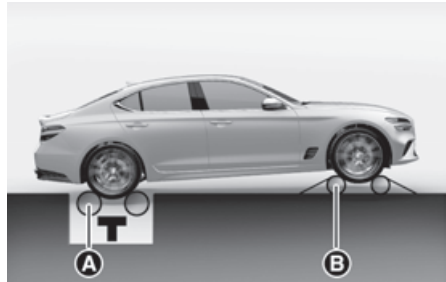

- [A] Roll tester (Speedometer)
- [B] Temporary free roller

An AWD vehicle should not be tested on a 2WD roll tester. If a 2WD roll tester must be used, perform the following procedure:

1. Check the tire pressures recommended for your vehicle.
2. Place the rear wheels on the roll tester for a speedometer test as shown in the illustration.
3. Release the parking brake.
4. Place the front wheels on the temporary free roller as shown in the illustration.

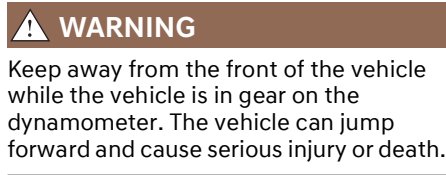

Limited Slip Differential

 if equipped

Limited Slip Differential refers to a feature equipped with a mechanism that controls the differential functions of the wheels in the rear differential.

The Limited Slip Differential helps improve handling performance when circling.

WARNING

Never run wheels with one of them lifted by the jack. It is extremely dangerous for a vehicle equipped with Limited Slip Differential.

Information

- For vehicles equipped with the LSD, internal friction sound may be heard when cornering. These conditions are normal and indicate that LSD is functioning properly. If the internal friction sound gradually increases, we recommend that the Rear Differential (for LSD) oil be changed by an authorized retailer of Genesis Branded products.
- Be sure to inject oil for exclusive use of LSD when replacing Rear Differential (for LSD) Oil. Refer to the “Recommended lubricants and capacities” in chapter 2.

Electronic control suspension

 if equipped

Electronic Control Suspension controls the vehicle suspension automatically using vehicle sensors to maximize driving comfort by taking into account the driving conditions such as speed, surface of the road, cornering, stopping requirements and acceleration.

System malfunction

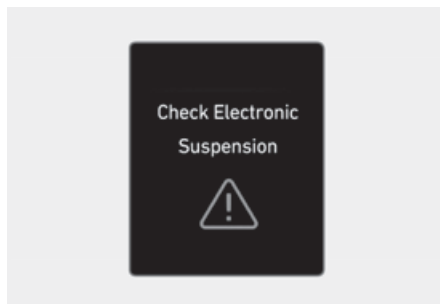

Check Electronic Suspension

When Electronic Control Suspension is not working properly, this warning message will appear on the cluster display. If this occurs, we recommend that the system be inspected by an authorized retailer of Genesis Branded products.

Launch control

 if equipped

Launch Control system controls the vehicle to reduce wheel spin or slip on a hard acceleration from a standing start.

Prerequisite for activation

Launch Control gets ready to be activated, when the following prerequisites are satisfied.

- The engine is warmed up.
- Malfunction warning lights related to the engine and ESC (Electronic Stability Control) are off.

CAUTION

For safety purposes, check the following conditions before using Launch control.

- The driver's seat belt is fastened.
- All doors, hood and trunk (or tailgate) are closed.
- The vehicle is at a complete stop.
- Align the steering wheel straight.

Launch Control activation

To activate Launch Control:

1. Select SPORT or SPORT+ mode using the drive mode selection knob (or button). SPORT or SPORT+ indicator will illuminate on the instrument cluster display.
2. Turn off ESC by pressing the ESC OFF button for more than 3 seconds. The ESC OFF indicator will illuminate on the instrument cluster.
3. Shift to the D (Drive) position.

4. Depress the brake pedal firmly with your left foot, while depressing the accelerator pedal down fully with your right foot. Then, the Engine RPM will reach an optimized level.

The message "**Launch Control Ready**" will appear on the instrument cluster display.

Sedan

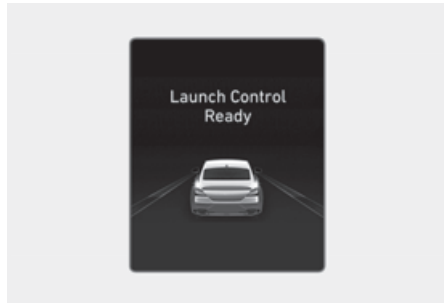

Shooting Brake

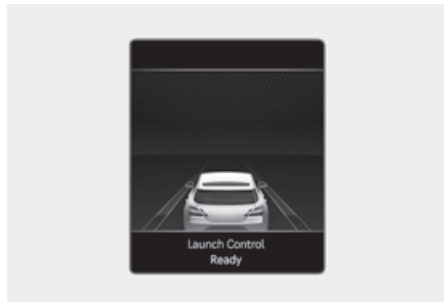

5. A smooth, quick release of the brake pedal, while maintaining full depression of the accelerator pedal will initiate launching of the vehicle.
6. During vehicle launching, continue to depress the accelerator pedal to keep the Launch Control system active until desired duration.

The message "**Launch Control Active**" will appear on the cluster display.

To deactivate (end) Launch Control, release the accelerator pedal.

Sedan

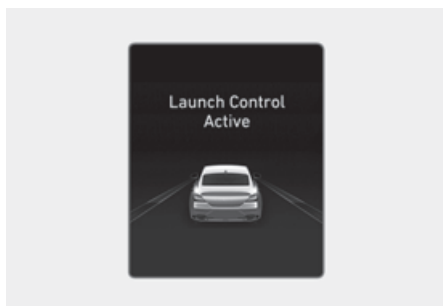

Shooting Brake

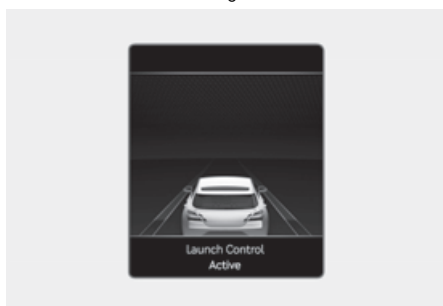

i Information

Launch Control is available again after cooling down by driving the vehicle for at least 3 minutes.

CAUTION

- Launch Control system is intended for use at a closed race track and not intended for use on public roads. It will not compensate for driver's who are inexperienced or lack familiarity with the race track.
- Do not use Launch Control during break-in period of the vehicle.

NOTICE

Constant use of Launch Control can put enormous stress on the vehicle resulting in premature wear of related components.

Limited use of Launch Control

**Transmission temperature too high.
Launch control not available**

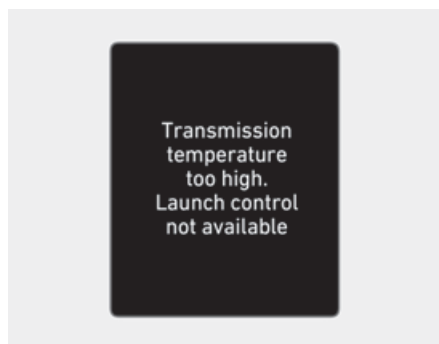

A warning message will pop up on the cluster display if the transmission fluid temperature is above a certain level while using Launch Control. Also, Launch Control will be automatically deactivated. If this occurs, the driver should cool down the transmission fluid temperature by driving the vehicle at a constant speed over 60 km/h (37 mph).

Idle Stop and Go (ISG)

 if equipped

Idle Stop and Go helps reduce fuel consumption by automatically shutting down the engine, when the vehicle is at a standstill (i.e. red stop light, stop sign, and traffic jam subject to certain prerequisite conditions being satisfied as listed below).

The engine is automatically started upon satisfying the starting conditions.

ISG system is always active, when the engine is running.

i Information

When the engine is automatically started by ISG system, warning lights (i.e. ABS, ESC, ESC OFF, MDPS, and parking brake warning light) may illuminate for a few seconds due to low battery voltage.

However, it does not indicate a malfunction with ISG system.

ISG system operation

Prerequisite for activation

ISG system operates in the following situations.

- The driver's seatbelt is fastened
- The driver's door and hood are closed
- The battery sensor is activated and the battery is sufficiently charged
- Outside temperature is not too low or too high
- The vehicle is driven over a constant speed and stops
- The climate control system satisfies the conditions
- The vehicle is sufficiently warmed up
- ISG related parts are working properly
- The incline is gradual

- The steering wheel is turned less than 180 degrees and then the vehicle stops
- The drive mode is not set to SPORT+ mode.

i Information

ISG system is not activated, when the prerequisites to activate the ISG system are unsatisfied. If this occurs, the ISG OFF button indicator illuminates, and the Auto Stop ((A)) indicator illuminates in yellow on the instrument cluster.

When the Auto Stop ((A)) indicator stays on the instrument cluster, we recommend that the system be inspected by an authorized retailer of Genesis Branded products.

Auto stop

When ISG is on the engine will be stopped automatically when both of the following occurs:

1. Vehicle speed decreases to 0 km/h(0 mph) full stop condition.
2. Brake pedal is depressed and gear is in D (Drive) or N (Neutral).

The Auto Stop ((A)) indicator illuminates in green on the instrument cluster, when the engine stops.

i Information

Idle stop cannot reoccur again until the vehicle speed goes above 8km/h (5mph) and then returns again to the automatic stop conditions as previously mentioned.

In the Auto Stop mode, if the engine hood is opened, ISG system will be deactivated.



When the system is deactivated, the ISG off button indicator will illuminate on the cluster display with a warning sound.

If this occurs, depress the brake pedal and restart the engine manually.

Auto start

When the engine stops automatically by ISG, the engine will restart if one of the following is done.

- Release the brake pedal.
- When Auto Hold is activated, take your foot off the brake pedal and then depress the accelerator pedal.
- While depressing the brake pedal, shift the gear from N (Neutral) or D (Drive) to R (Reverse) or P (Park).
- While depressing the brake pedal, shift the gear from N (Neutral) to D (Drive).

The Auto Stop ((A)) indicator goes off on the instrument cluster, when the engine is restarted.

Cluster display messages

The messages appear on the instrument cluster to help use ISG system.

Auto Stop is Off. Shift to P or N and start engine manually

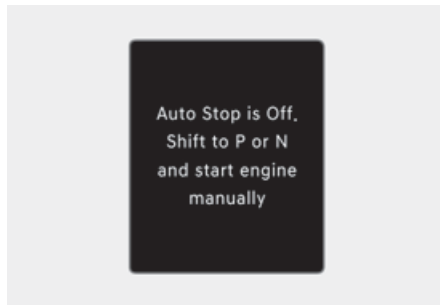

When the system is deactivated, the ISG off button indicator will illuminate and a message will appear on the cluster display with a warning sound in the following situations.

- When the engine hood is opened.
- When ISG system is not working normally.

If this occurs, depress the brake pedal and restart the engine manually. For your safety, restart the vehicle in the P (Park) position.

AUTO STOP elapsed time

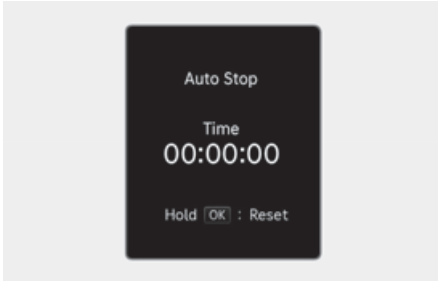

AUTO STOP display shows the elapsed time of engine stop by the Idle Stop and Go system.

You may check AUTO STOP elapsed time in the Utility view on the instrument cluster.

Refer to “Cluster display (Type A), Cluster display (Type B)” section in chapter 4.

ISG system off



Press the ISG OFF button to turn off ISG system. The ISG OFF button indicator will illuminate. To use the system, press the ISG OFF button again.

Forced to restart engine

The engine is automatically restarted in the following situations.

- The engine has stopped for about 5 minutes
- The air conditioning is ON with the fan speed set to higher position than 7 step
- The front defroster is ON
- The battery is weak
- The cooling and heating performance of the climate control system is unsatisfactory
- The vehicle is shifted to P (Park) when Auto Hold is activated
- The door is opened or the seatbelt is unfastened when Auto Hold is activated
- The EPB switch is pressed when Auto Hold is activated

The Auto Stop ((A)) indicator blinks in green for 5 seconds on the instrument cluster when the engine is restarted.

WARNING

When the engine is in Idle Stop mode, the engine may restart without the driver taking any action. Before leaving the vehicle or working on the engine compartment, turn off the engine by pressing the ENGINE START/STOP button to the OFF position.

ISG malfunction

ISG system may not operate when there is a malfunction with the ISG sensors or ISG system.

The followings will occur, when there is a malfunction with the ISG system:

- The Auto Stop ((A)) indicator illuminates in yellow on the instrument cluster.
- The light on the ISG OFF button will illuminate.

We recommend that you contact an authorized retailer of Genesis Branded products.

Calibrating the Battery Sensor

If the AGM battery is reconnected or replaced, ISG system will not operate immediately. If you want to use the system, the battery sensor needs to be calibrated following the below procedure.

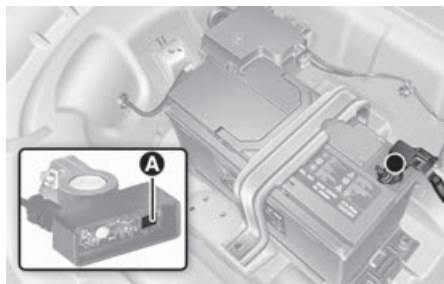

[A] Battery sensor

1. Turn off the engine.
2. Disconnect all electronic devices that were additionally installed after the vehicle was delivered, such as navigation, dashcam, etc.
3. After 4 hours with the engine off, turn the engine on and off 3 to 4 times.

i Information

The ISG system may not operate in the following situations.

- There is a malfunction with the ISG system.
- The battery is weak.
- The brake vacuum pressure is low.
- If this occurs, have the ISG system checked by an authorized retailer of Genesis Branded products.

NOTICE

- Use only a genuine Genesis ISG battery for replacement. If not, the ISG system may not properly operate.
- Do not recharge the ISG battery with a general battery charger. It may damage or explode the ISG battery.
- Do not remove the battery cap. The battery electrolyte, which is harmful to the human body, may leak out.

Coasting

 if equipped

When certain conditions are met, the engine is automatically decoupled from the transmission while gear remains in D (Drive). When Coasting is operating, the engine stays at idling speed to reduce fuel consumption and increase coasting distance.

Coasting setting

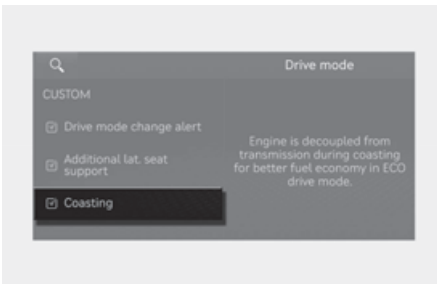

- The Coasting function must be turned ON from the Settings menu in the infotainment system. Select:
 - **Setup (Settings) > Vehicle > Drive Mode > Coasting**
- When Coasting is turned ON and the conditions are met, the function operates with a **Coasting** message illuminated on the instrument cluster.

i Information

The infotainment system may change after software updates. For more information, refer to the manual provided in the infotainment system and the quick reference guide.

Coasting operating conditions

The Coasting function will operate when the accelerator pedal is depressed and released under the following conditions.

- ECO is selected for driving mode
- ECO is selected for Powertrain in the CUSTOM menu from the infotainment system (if equipped). If Smart is selected, driver acceleration should be mild
- The gear is in D (Drive)
- The Smart Cruise Control button is OFF
- Smart Cruise Control on standby
- The accelerator or brake pedal is not depressed
- The vehicle's speed is within 50-160 km/h (30-100 mph) range
- The road gradient is within -5-+5% range

i Information

- If the front radar for smart cruise control system cannot operate normally, the inter-vehicle distance and relative speed condition are automatically ignored.
- The Coasting function works after the engine is turned on, the transmission is warmed up, and the engine sensor self-diagnosis is completed.
- Depending on the driving situation, Coasting operation may be temporarily delayed even if the above conditions are met.

Coasting release conditions

The Coasting function will be automatically released when the following conditions are met.

- Comfort, Sport, Sport+ is selected for driving mode
- The driver uses the paddle shifter
- Smart Cruise Control is activated (Set speed appears on the cluster)
- The vehicle's speed exceeds 50-160 km/h (30-100 mph) range
- The road gradient is under -5% or over +5%
- If the distance between the vehicle ahead is too close or the relative speed changes momentarily in CUSTOM mode
- If lane change is predicated in CUSTOM mode (e.g. the turn signal is turned ON or a LKA warning appears due to steering wheel control, etc.)

i Information

It is recommended to turn off the Coasting function if you are driving under frequently stop-and-go condition. Change the drive mode to Comfort or Sport or deselect Coasting from the infotainment system.

NOTICE

- If the accelerator pedal is pressed quickly for accelerating with the Coasting function in operation, acceleration may occur after the engagement of the clutch inside the transmission. In turn, the driver may continue to feel acceleration even after the system is turned off.
- Driving with the Coasting function off may be required in some cases since the engine brake is not applied while the Coasting function is operating.
- Operating the infotainment system to activate or deactivate the Coasting function while driving may be dangerous as the driver's attention is dispersed.

Drive mode integrated control system

Drive mode may be selected according to the driver's preference or road condition.



Drive mode

The mode changes whenever the DRIVE MODE selection knob is rotated.

COMFORT mode

COMFORT mode provides smooth driving and comfortable riding.

ECO mode



ECO mode helps improve fuel efficiency for eco-friendly driving. Fuel efficiency varies according to the driver's driving habit and road condition.

- When ECO mode is selected, the ECO indicator will illuminate on the instrument cluster.
- When ECO mode is activated:
 - The acceleration response may be slightly reduced if the accelerator pedal is depressed moderately.
 - The air conditioner performance may be limited.
 - The shift pattern of the automatic transmission may change.
 - Engine noise may be louder at some automatic transmission shifts as down-shift requires pressing down more on the accelerator.

The above situations are normal conditions when ECO mode is activated to help improve fuel efficiency.

Limitations of the ECO mode

If the following conditions occur while ECO mode is operating, the system operation is limited even though there is no change in the ECO indicator.

- When coolant temperature is low:
The system will be limited until engine performance becomes normal.
- When driving up a hill:
The system will be limited to gain power when driving uphill because engine torque is restricted.
- When driving the vehicle in manual shift mode using the paddle shifter.
The system will be limited according to the shift location.

SPORT mode

SPORT

SPORT mode provides sporty but firm if equipped with ECS. In SPORT mode, the fuel efficiency may decrease.

- When SPORT mode is selected, the SPORT indicator will illuminate on the instrument cluster.
- Whenever the engine is restarted, the drive mode will revert back to COMFORT mode. If SPORT mode is desired, re-select SPORT mode.
- When SPORT mode is activated:
 - The engine rpm will tend to remain raised over a certain length of time even after releasing the accelerator
 - Upshifts are delayed when accelerating

CUSTOM mode

 if equipped

CUSTOM

In CUSTOM mode, the driver can select separate modes for each items in the infotainment system.

- Powertrain:
ECO/COMFORT/SPORT/SPORT+
- Steering wheel:
COMFORT/SPORT/SPORT+
- Suspension:
COMFORT/SPORT/SPORT+
- AWD system: ECO/COMFORT/SPORT

***i* Information**

The infotainment system may change after software updates. For more information, refer to the manual provided in the infotainment system and the quick reference guide.

- When CUSTOM mode is selected, the CUSTOM indicator will illuminate on the instrument cluster.
- Whenever the engine is restarted, the drive mode will revert back to COMFORT mode. If CUSTOM mode is desired, re-select CUSTOM mode.

SPORT+ mode

 if equipped

SPORT+

The SPORT+ mode provides sporty but firm riding. In the SPORT+ mode, the fuel efficiency may decrease.

- When the SPORT+ mode is selected, the SPORT+ indicator will illuminate on the instrument cluster.
- Whenever the engine is restarted, the drive mode will revert back to the COMFORT mode. If the SPORT+ mode is desired, re-select the SPORT+ mode.
- When the SPORT+ mode is activated:
 - The engine RPM will tend to remain raised over a certain length of time even after releasing the accelerator
 - Upshifts are delayed when accelerating
 - Downshifts are advanced while braking.

NOTICE

- In the SPORT or SPORT+ mode, the fuel efficiency may decrease.
 - ISG is deactivated in the SPORT+ mode.
-

***i* Information**

SPORT+ mode applied to vehicle equipped with ESC.

Vehicle characteristic

The characteristic of each component varies according to which drive mode is selected.

A/T	Component	DRIVE MODE		
		COMFORT Mode	SPORT Mode	SPORT+ Mode
Engine & Driving	Power train	COMFORT	SPORT	SPORT+
	Launch Control	Off	On	On
Chassis	Steering	COMFORT	SPORT	SPORT+
	ESC*1	COMFORT	SPORT	SPORT (TCS*2 OFF)
	Suspension	COMFORT	SPORT	SPORT+
Sound	ASD*3	COMFORT	SPORT	SPORT
	Variable exhaust	COMFORT	SPORT	SPORT

*1 Electronic Stability Control

*2 Traction Control System

*3 Active Sound Design

When driving in the CUSTOM mode, Launch Control/Active Sound Design may vary depending on the CUSTOM mode-Powertrain system settings.

Semi active engine mount

 if equipped

If the Semi Active Engine Mount is equipped to improve vehicle's noise and vibration, the solenoid valve of the semi active engine mount makes a clack sound when the vehicle enters or exits a certain mode such as speed or engine rpm. It is not a malfunction but it is a normal condition.

Active air flap

 if equipped



Active air flap system controls the air flap below the front bumper to cool the vehicle parts and improve energy efficiency.

Information

Active air flap system could be activated regardless of the vehicle's condition (Parking, driving, etc.).

Malfuction

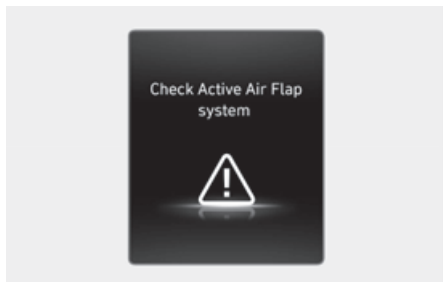

The active air flap system may not operate normally if the air flap is temporarily opened due to foreign factors or if the controller is contaminated by snow or rain, etc.

When “**Check Active Air Flap system**” is popped up on display, stop the vehicle in a safe place and check the status of the air flap.

Start the vehicle after performing the necessary work like foreign matter removal and waiting 10 minutes. If the pop-up remains up we recommend that you contact an authorized retailer of Genesis Branded products.

CAUTION

- Regardless of the pop-up, if the air flaps aren't in the same position, stop the vehicle and wait for 10 minutes and start the vehicle and inspect the air flap.
- The active air flap system is actuated by motors. Do not disturb actuation or apply force excessively. It may cause failure.

Special driving conditions

Hazardous driving conditions

When hazardous driving elements are encountered such as water, snow, ice, mud and sand, take the following precautions:

- Drive cautiously and maintain a longer braking distance.
- Avoid abrupt braking or steering.
- When your vehicle is stuck in snow, mud, or sand, use second gear. Accelerate slowly to avoid unnecessary wheel spin.
- Put sand, rock salt, tire chains or other non-slip materials under the wheels to provide additional traction while the vehicle becomes stuck in ice, snow, or mud.

WARNING

Downshifting with an automatic transmission while driving on slippery surfaces can cause an accident. The sudden change in tire speed could cause the tires to skid. Be careful when downshifting on slippery surfaces.

Rocking the vehicle

If it is necessary to rock the vehicle to free it from snow, sand, or mud, first turn the steering wheel right and left to clear the area around your front wheels. Then, shift back and forth between R (Reverse) and a forward gear.

Try to avoid spinning the wheels, and do not race the engine.

To prevent transmission wear, wait until the wheels stop spinning before shifting gears. Release the accelerator pedal while shifting, and press lightly on the accelerator pedal while the transmission is in gear. Slowly spinning the wheels in forward and reverse directions causes a rocking motion that may free the vehicle.

WARNING

If the vehicle is stuck and excessive wheel spin occurs, the temperature in the tires can increase very quickly. If the tires become damaged, a tire blow out or tire explosion can occur. This condition is dangerous - you and others may be injured. Do not attempt this procedure if people or objects are anywhere near the vehicle.

If you attempt to free the vehicle, the vehicle can overheat quickly, possibly causing an engine compartment fire or other damage. Try to avoid spinning the wheels as much as possible to prevent overheating of either the tires or the engine. DO NOT allow the vehicle to spin the wheels above 56 km/h (35 mph).

i Information

The ESC system must be turned OFF before rocking the vehicle.

NOTICE

If you are still stuck after rocking the vehicle a few times, have the vehicle pulled out by a tow vehicle to avoid engine overheating, possible damage to the transmission, and tire damage. Refer to the "Towing" section in chapter 8.

Smooth cornering

Avoid braking or gear changing in corners, especially when roads are wet. Ideally, corners should always be taken under gentle acceleration.

Driving at night

Night driving presents more hazards than driving in the daylight. Here are some important tips to remember:

- Slow down and keep more distance between you and other vehicles, as it may be more difficult to see at night, especially in areas where there may not be any street lights.
- Adjust your mirrors to reduce the glare from other drivers' headlights.
- Keep your headlights clean and properly aimed. Dirty or improperly aimed headlights will make it much more difficult to see at night.
- Avoid staring directly at the headlights of oncoming vehicles. You could be temporarily blinded, and it will take several seconds for your eyes to readjust to the darkness.

Driving in the rain

Rain and wet roads can make driving dangerous. Here are a few things to consider when driving in the rain or on slick pavement:

- Slow down and allow extra following distance. A heavy rainfall makes it harder to see and increases the distance needed to stop your vehicle.
- Turn OFF your Cruise Control. (if equipped)
- Replace your windshield wiper blades when they show signs of streaking or missing areas on the windshield.
- Be sure your tires have enough tread. If your tires do not have enough depth of tire tread, making a quick stop on wet pavement can cause a skid and possibly lead to an accident. Refer to the "Tire replacement" section in chapter 9.
- Turn on your headlights to make it easier for others to see you.
- Driving too fast through large puddles can affect your brakes. If you must go through puddles, try to drive through them slowly.
- If you believe your brakes may be wet, apply them lightly while driving until normal braking operation returns.

Hydroplaning

If the road is wet enough and you are going fast enough, your vehicle may have little or no contact with the road surface and actually ride on the water. The best advice is SLOW DOWN when the road is wet.

The risk of hydroplaning increases as the depth of tire tread decreases, refer to the "Tire care" section in chapter 9.

Driving in flooded areas

Avoid driving through flooded areas unless you are sure the water is no higher than the bottom of the wheel hub. Drive through any water slowly. Allow adequate stopping distance because brake performance may be reduced.

After driving through water, dry the brakes by gently applying them several times while the vehicle is moving slowly.

Highway driving

Tires

Adjust the tire inflation, as specified. Under-inflation may overheat or damage the tires.

Do not install worn-out or damaged tires, which may reduce traction or fail the braking operation.

i Information

Never over-inflate your tires above the maximum inflation pressure, as specified on your tires.

Fuel, engine coolant and engine oil

Driving at higher speeds on the highway consumes more fuel and is less efficient than driving at a slower, more moderate speed. Maintain a moderate speed in order to conserve fuel when driving on the highway.

Be sure to check both the engine coolant level and the engine oil before driving.

Drive belt

A loose or damaged drive belt may overheat the engine.

Winter driving

The severe weather conditions of winter quickly wear out tires and cause other problems. To minimize winter driving problems, you should take the following suggestions:

Snow or icy conditions

You need to keep sufficient distance between your vehicle and the vehicle in front of you.

Apply the brakes gently. Speeding, rapid acceleration, sudden brake applications, and sharp turns are potentially very hazardous practices. During deceleration, use engine braking to the fullest extent. Sudden brake applications on snowy or icy roads may cause the vehicle to skid.

To drive your vehicle in deep snow, it may be necessary to use snow tires or to install tire chains on your tires.

Always carry emergency equipment. Some of the items you may want to carry include tire chains, tow straps or chains, a flashlight, emergency flares, sand, a shovel, jumper cables, a window scraper, gloves, ground cloth, coveralls, a blanket, etc.

Snow tires

WARNING

Snow tires should be equivalent in size and type to the vehicle's standard tires. Otherwise, the safety and handling of your vehicle may be adversely affected.

We recommend that you use snow tires when road temperature is below 7°C (45°F). Refer to the below chart, and mount the recommended snow tire for your vehicle.

Standard tire				Recommended snow tire			
Front		Rear		Front		Rear	
Tire size	Wheel size	Tire size	Wheel size	Tire size	Wheel size	Tire size	Wheel size
225/45R18	8.0J x 18	225/45R18	8.0J x 18	225/45R18	8.0J x 18	225/45R18	8.0J x 18
				225/40R19	8.0J x 19	255/35R19	8.5J x 19
225/40R19	8.0J x 19	255/35R19	8.5J x 19	225/45R18	8.0J x 18	225/45R18	8.0J x 18
				225/40R19	8.0J x 19	255/35R19	8.5J x 19

If you mount snow tires on your vehicle, make sure to use the same Inflation pressure as the original tires. Mount snow tires on all four wheels to balance your vehicle's handling in all weather conditions. The traction provided by snow tires on dry roads may not be as high as your vehicle's original equipment tires. Check with the tire dealer for maximum speed recommendations.

Summer tires

 if equipped

- Summer tires are used to maximize the driving performance on dry roads.
- If the temperature is below 7 °C (44.6 °F) or you are driving on snowy or icy roads, the summer tires lose their brake performance and traction as the tire grip weakens significantly.
- If the temperature is below 7 °C (44.6 °F) or you are driving on snowy or icy roads, mount snow tires or all-season tires of the same size with your vehicle's standard tire for safe driving. Both snow and all-season tires have M+S markings.
- When using the M+S tires, use tires with the same tread produced by the same manufacturer for safe driving.
- When driving with the M+S tires with the lower maximum allowable speed than that of the vehicle's standard summer tire, be careful not to exceed the speed allowed for the M+S tires.

Tire chains



Since the sidewalls on some radial tires are thinner than other types of tires, they may be damaged by mounting certain types of tire chains on them. Therefore, the use of snow tires is recommended instead of tire chains. Do not mount tire chains on vehicles equipped with aluminum wheels; if unavoidable, use AutoSock (fabric snow chain). Install the tire chain after reviewing the instructions provided with the tire chains. Damage to your vehicle caused by improper tire chain use is not covered by your vehicle manufacturer's warranty.

WARNING

The use of tire chains may adversely affect vehicle handling:

- Drive less than 30 km/h (20 mph) or the chain manufacturer's recommended speed limit, whichever is lower.
 - Drive carefully and avoid bumps, holes, sharp turns, and other road hazards, which may cause the vehicle to bounce.
 - Avoid sharp turns or locked wheel braking.
-

i Information

- Install AutoSock (fabric snow chain) only in pairs and on the rear tires. It should be noted that installing AutoSock (fabric snow chain) on the tires will provide a greater driving force, but will not prevent side skids.
- Do not install studded tires without first checking local and municipal regulations for possible restrictions against their use.

Chain Installation

When installing AutoSock (fabric snow chain), follow the manufacturer's instructions and mount them as tightly as possible. Drive slowly (less than 30 km/h (20 mph)) with chains installed. If you hear the chains contacting the body or chassis, stop and tighten them. If they still make contact, slow down until the noise stops. Remove the AutoSock (fabric snow chain) as soon as you begin driving on cleared roads.

When mounting AutoSock (fabric snow chain), park the vehicle on level ground away from traffic. Turn on the vehicle Hazard Warning Flasher and place a triangular emergency warning device behind the vehicle (if available).

Always place the vehicle in P (Park), apply the parking brake and turn off the engine before installing tire chains.

NOTICE

When using AutoSock (fabric snow chain):

- Wrong size chains or improperly installed chains can damage your vehicle's brake lines, suspension, body and wheels.
- If you hear noise caused by chains contacting the body, retighten the chain to prevent contact with the vehicle body.
- To prevent body damage, retighten the chains after driving 0.5-1.0 km (0.3-0.6 miles).

Winter precautions

Use high quality ethylene glycol coolant

Your vehicle is delivered with high quality ethylene glycol coolant in the cooling system. It is the only type of coolant that should be used because it helps prevent corrosion in the cooling system, lubricates the water pump and prevents freezing. Be sure to replace or replenish your coolant in accordance with the maintenance schedule in chapter 9. Before winter, have your coolant tested to assure that its freezing point is sufficient for the temperatures anticipated during the winter.

Check battery and cables

Winter temperatures affect battery performance. **Inspect the battery and cables, as specified in chapter 9.** The battery charging level can be checked by an authorized retailer of Genesis Branded products or in a service station.

Change to “winter weight” oil if necessary

In some regions during winter, it is recommended to use the “winter weight” oil with lower viscosity. In addition, replace the engine oil and filter if it is close to the next maintenance interval. Fresh engine oil ensures optimum engine operation during the winter months. For further information, refer to the chapter 2. When you are not sure about a type of winter weight oil, we recommend that you consult an authorized retailer of Genesis Branded products.

Check spark plugs and ignition system

Inspect the spark plugs, as specified in chapter 9. If necessary, replace them. Also check all ignition wirings and components for any cracks, wear-out, and damage.

To prevent locks from freezing

To prevent the locks from being frozen, spray approved de-icing fluid or glycerin into key holes. When a lock opening is already covered with ice, spray approved de-icing fluid over the ice to remove it. When an internal part of a lock freezes, try to thaw it with a heated key. Carefully use the heated key to avoid an injury.

Use approved window washer anti-freeze solution in system

To prevent the window washer from being frozen, add authorized window washer anti-freeze solution, as specified on the window washer container. Window washer anti-freeze solution is available from an authorized retailer of Genesis Branded products, and most vehicle accessory outlets. Do not use engine coolant or other types of anti-freeze solution, to prevent any damage to the vehicle paint.

Do not let your parking brake freeze

Under some conditions your parking brake can freeze in the engaged position. This is most likely to happen when there is an accumulation of snow or ice around or near the rear brakes or if the brakes are wet. When there is the risk that your parking brake may freeze, temporarily apply it with the gear in P (Park). Also, block the rear wheels in advance, so the vehicle may not roll. Then, release the parking brake.

Do not let ice and snow accumulate underneath

Under some conditions, snow and ice can build up under the fenders and interfere with the steering. When driving in such conditions during the severe winter, you should check underneath the vehicle on a regular basis, to ensure that the front wheels and the steering components is unblocked.

Carry emergency equipment

In accordance with weather conditions, you should carry appropriate emergency equipment, while driving. Some of the items you may want to carry include tire chains, tow straps or chains, flashlight, emergency flares, sand, shovel, jumper cables, window scraper, gloves, ground cloth, coveralls, blanket, etc.

Do not place objects or materials in the engine compartment

Putting objects or materials in the engine compartment may cause an engine failure or combustion, because they may block the engine cooling. Such damage will not be covered by the manufacturer’s warranty.

Drive your vehicle when water vapor condenses and accumulates inside the exhaust pipes

When the vehicle is stopped for a long time in winter while the engine is running, water vapor may condense and accumulate inside the exhaust pipes. Water in the exhaust pipes may cause noise, etc., but it is drained driving at medium to high speed.

Check wiper blades

Clear ice and snow from the windshield and rear glass. Check if the wiper blades are frozen and stuck to the glass.

If it snows while driving, the wiper may temporarily stop operating to prevent itself from being damaged if snow accumulates at the upper and lower part of glass due to its operation. If it stops, clear the snow accumulated at the upper and lower part of the glass and then operate the wiper.

Stopping of wiper operation due to snow accumulation is not a failure. It is to prevent safety issue and damage from occurring when the wiper continues to operate without removing snow while driving the vehicle.

Vehicle weight

Two labels on your driver's door sill show how much weight your vehicle was designed to carry: the Tire and Loading Information Label and the Certification Label.

Before loading your vehicle, familiarize yourself with the following terms for determining your vehicle's weight ratings, from the vehicle's specifications and the Certification Label:

Base Curb Weight

This is the weight of the vehicle including a full tank of fuel and all standard equipment. It does not include passengers, cargo, or optional equipment.

Vehicle Curb Weight

This is the weight of your new vehicle when you picked it up from your dealer plus any aftermarket equipment.

Cargo Weight

This figure includes all weight added to the Base Curb Weight, including cargo and optional equipment.

GAW (Gross Axle Weight)

This is the total weight placed on each axle (front and rear) - including vehicle curb weight and all payload.

GAWR (Gross Axle Weight Rating)

This is the maximum allowable weight that can be carried by a single axle (front or rear). These numbers are shown on the Certification Label. The total load on each axle must never exceed its GAWR.

GVW (Gross Vehicle Weight)

This is the Base Curb Weight plus actual Cargo Weight plus passengers.

GVWR (Gross Vehicle Weight Rating)

This is the maximum allowable weight of the fully loaded vehicle (including all options, equipment, passengers and cargo). The GVWR is shown on the Certification Label located on the driver's door sill.

Overloading



WARNING

The Gross Axle Weight Rating (GAWR) and the Gross Vehicle Weight Rating (GVWR) for your vehicle are on the Certification Label attached to the driver's (or front passenger's) door. Exceeding these ratings can cause an accident or vehicle damage. You can calculate the weight of your load by weighing the items (and people) before putting them in the vehicle. Be careful not to overload your vehicle.

Trailer towing

We do not recommend using this vehicle for trailer towing.

7. Driver assistance system

Driver assistance system notice.....	7-4
Forward Collision-Avoidance Assist (FCA) (Sensor fusion).....	7-4
Forward Collision-Avoidance Assist settings.....	7-6
Forward Collision-Avoidance Assist operation.....	7-9
Forward Collision-Avoidance Assist malfunction and limitations.....	7-15
Lane Keeping Assist (LKA).....	7-23
Lane Keeping Assist settings.....	7-23
Lane Keeping Assist operation.....	7-25
Lane Keeping Assist malfunction and limitations	7-28
Blind-Spot Collision-Avoidance Assist (BCA).....	7-30
Blind-Spot Collision-Avoidance Assist settings.....	7-32
Blind-Spot Collision-Avoidance Assist operation.....	7-34
Blind-Spot Collision-Avoidance Assist malfunction and limitations.....	7-36
Safe Exit Warning (SEW)	7-41
Safe Exit Warning settings	7-42
Safe Exit Warning operation.....	7-43
Safe Exit Warning malfunction and limitations	7-45
Manual Speed Limit Assist (MSLA).....	7-47
Manual Speed Limit Assist operation	7-47
Intelligent Speed Limit Assist (ISLA)	7-49
Intelligent Speed Limit Assist settings	7-50
Intelligent Speed Limit Assist operation	7-52
Intelligent Speed Limit Assist malfunction and limitations	7-54
Driver Attention Warning (DAW)	7-56
Driver Attention Warning settings	7-56
Driver Attention Warning operation	7-57
Driver Attention Warning malfunction and limitations.....	7-59
Blind-Spot View Monitor (BVM)	7-62
Blind-Spot View Monitor settings.....	7-62
Blind-Spot View Monitor operation.....	7-63
Blind-Spot View Monitor malfunction.....	7-63
Cruise Control (CC).....	7-64
Cruise Control operation.....	7-64
Smart Cruise Control (SCC)	7-68
Smart Cruise Control settings.....	7-68

Smart Cruise Control operation	7-70
Smart Cruise Control malfunction and limitations	7-79
Navigation-based Smart Cruise Control (NSCC).....	7-85
Navigation-based Smart Cruise Control settings	7-85
Navigation-based Smart Cruise Control operation	7-86
Limitations of Navigation-based Smart Cruise Control	7-87
Lane Following Assist (LFA).....	7-91
Lane Following Assist settings	7-91
Lane Following Assist operation	7-92
Lane Following Assist malfunction and limitations	7-96
Highway Driving Assist (HDA).....	7-97
Highway Driving Assist settings	7-98
Highway Driving Assist operation	7-100
Highway Driving Assist malfunction and limitations	7-103
Rear View Monitor (RVM).....	7-105
Rear View Monitor settings	7-106
Rear View Monitor operation	7-107
Rear View Monitor malfunction and limitations	7-110
Surround View Monitor (SVM)	7-110
Surround View Monitor settings	7-111
Surround View Monitor operation.....	7-113
Surround View Monitor malfunction and limitations	7-116
Rear Cross-Traffic Collision-Avoidance Assist (RCCA)	7-117
Rear Cross-Traffic Collision-Avoidance Assist settings.....	7-118
Rear Cross-Traffic Collision-Avoidance Assist operation.....	7-119
Rear Cross-Traffic Collision-Avoidance Assist malfunction and limitations	7-123
Reverse Parking Distance Warning (PDW).....	7-127
Reverse Parking Distance Warning settings	7-128
Reverse Parking Distance Warning operation.....	7-128
Reverse Parking Distance Warning malfunction and limitations	7-129
Forward/Reverse Parking Distance Warning (PDW)	7-132
Forward/Reverse Parking Distance Warning settings	7-133
Forward/Reverse Parking Distance Warning operation	7-133
Forward/Reverse Parking Distance Warning malfunction and limitations.....	7-136
Declaration of conformity	7-139

7. Driver assistance system

Front radar.....	7-139
Rear corner radar	7-141

Driver assistance system notice

i Information

Due to infotainment software versions, the description of each function of the driver assistance system may differ from the owner's manual.

Forward Collision-Avoidance Assist (FCA) (Sensor fusion)

 If equipped

Basic function

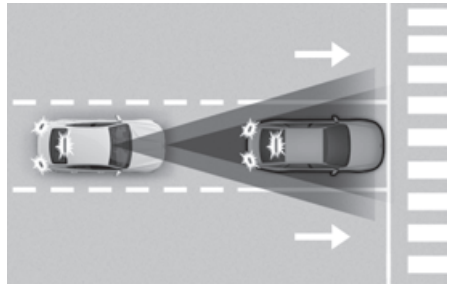

Forward Collision-Avoidance Assist detects a vehicle, a powered two-wheeler, a pedestrian, or a cyclist ahead on the road and may warn you of a possible collision with a warning message on the instrument cluster and a warning sound. Also, Forward Collision-Avoidance Assist may assist with braking your vehicle to help reduce collision speed or avoid a collision.

Junction Turning function

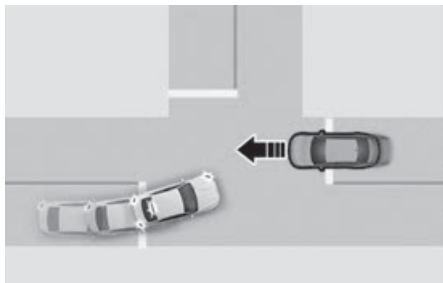

Junction Turning function can help avoid a collision with an oncoming vehicle or powered two-wheeler in an adjacent lane when turning left (left-hand drive) or right (right-hand drive) at a crossroad with the turn signal on by applying emergency braking.

Direct Oncoming function

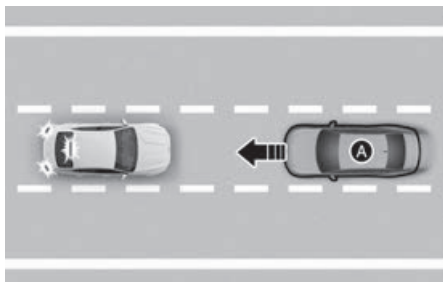

[A] Oncoming vehicle

Direct Oncoming function helps reduce the speed at the collision when a vehicle or powered two-wheeler approaching from the opposite side is detected.

Detecting sensor



- (1) Front view camera
(2) Front radar

See the illustration above for the detailed location of the detecting sensors.

⚠ CAUTION

Take the following precautions to maintain optimal performance of the detecting sensor:

- Never disassemble the detecting sensor or sensor assembly, or cause any damage to it.
- If the detecting sensors have been replaced or repaired, we recommend that you have your vehicle inspected by an authorized retailer of Genesis Branded products.
- Never install any accessories or stickers on the front windshield, or tint the front windshield.
- Exercise extreme caution to keep the front view camera dry.
- Never place any reflective objects (for example, white paper, mirror) over the dashboard.
- Do not place any objects near the front windshield or install any accessories on the front windshield. It can affect the performance of the defogging and defrosting function of the climate control system, which may prevent the Driver Assistance systems from operating.

- Do not apply license plate frame or objects, such as a bumper sticker, film or a bumper guard, near the front radar cover.
- Do not change the position of the license plate. The front radar's detection and control performance may be affected.
- Always keep the front radar and cover clean and free of dirt and debris.
Use only a soft cloth to wash the vehicle. Do not spray pressurized water directly on the sensor or sensor cover.
- If the radar or around the radar has been damaged or impacted in any way, Forward Collision-Avoidance Assist may not properly operate even though a warning message does not appear on the cluster. We recommend that the vehicle be inspected by an authorized retailer of Genesis Branded products.
- Use only genuine parts to repair or replace a damaged front radar cover. Do not apply paint to the front radar cover.
- If a trailer or hitch mounted carrier is attached, it may adversely affect the performance of the Forward Collision-Avoidance Assist.

Forward Collision-Avoidance Assist settings

Forward safety



With the engine on, select **Setup (Settings) > Vehicle > Driver assistance > Driving safety > Forward safety** in the infotainment system to set whether to use each function.

- If **“Forward safety”** is selected, Forward Collision-Avoidance Assist will warn the driver with a warning message, an audible warning depending on the collision risk levels. Braking assist will be applied depending on the collision risk levels. If **“Forward safety”** is deselected, Forward Safety will turn off. The 🚨 warning light will illuminate on the cluster.

The driver can monitor Forward Collision-Avoidance Assist On/Off status from the Settings menu. If the 🚨 warning light remains ON when Forward Collision-Avoidance Assist is on, we recommend that the vehicle be inspected by an authorized retailer of Genesis Branded products.

⚠ WARNING

When the engine is restarted, Forward Collision-Avoidance Assist will always turn on. However, if “**Forward safety**” is deselected, the driver should always be aware of the surroundings and drive safely.

⚠ CAUTION

The setting for Forward Safety includes **Basic function, Junction Turning, and Direct Oncoming.**

i Information

The infotainment system may change after software updates. For more information, refer to the manual provided in the infotainment system and the quick reference guide.

Forward Safety Warning Timing



With the engine on, select **Setup (Settings) > Vehicle > Driver assistance > Driving safety > Forward Safety Warning Timing** in the infotainment system to change the initial warning activation time for Forward Collision-Avoidance Assist. The warning time can be set to either “**Normal**” or “**Later**”

- Use “**Normal**” in normal driving conditions. If the Warning Timing seems sensitive, change it to “**Later**”.
 - If “**Later**” is selected, Forward Collision-Avoidance Assist, warns the driver more slowly.

⚠ CAUTION

- Even though “**Normal**” is selected for Warning Timing, if the front vehicle suddenly stops, the warning may seem late.
- Select “**Later**” for Warning Timing when traffic is light and when driving speed is slow.

i Information

- When the engine is restarted, Forward Safety Warning Timing maintains the last setting.
- The infotainment system may change after software updates. For more information, refer to the manual provided in the infotainment system and the quick reference guide.

Warning methods

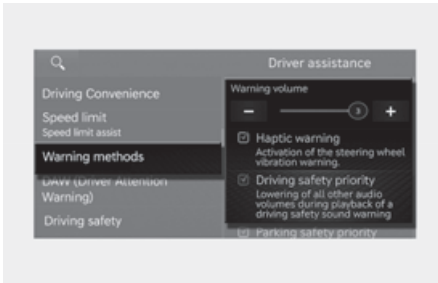

The Warning methods can be set with the engine on.

- **Warning volume:** Select **Setup (Settings) > Vehicle > Driver assistance > Warning methods > Warning volume** from the settings menu in the infotainment system to change the warning volume.

If you turn off the **Warning volume**, for your safety, the function may warn you with a low volume (if equipped).

- **Haptic warning:** Select **Setup (Settings) > Vehicle > Driver assistance > Warning methods > Haptic warning** from the settings menu in the infotainment system to set haptic warning (if equipped).
- **Driving safety priority:** Select **Setup (Settings) > Vehicle > Driver assistance > Warning methods > Driving safety priority** from the settings menu in the infotainment system.

If “**Driving safety priority**” is selected, the vehicle lowers all other audio volumes when the warning sounds for safe driving.

i Information

The infotainment system may change after software updates. For more information, refer to the manual provided in the infotainment system and the quick reference guide.

i Information

- If you change the Warning methods, the Warning methods of other Driver assistance systems may change.
- The **Warning volume** and **Haptic warning** cannot be turned off at the same time. When one of the warning is turned off the other is activated.
- If the engine is restarted, Warning methods will maintain the last setting.
- The setting menu may not exist depending on the vehicle specification.

Forward Collision-Avoidance Assist operation

Basic function

The basic function for Forward Collision-Avoidance Assist is to warn and help control the vehicle depending on the collision risk level: “Collision Warning”, “Emergency Braking” and “Stopping vehicle and ending brake control”.

Collision Warning

Sedan

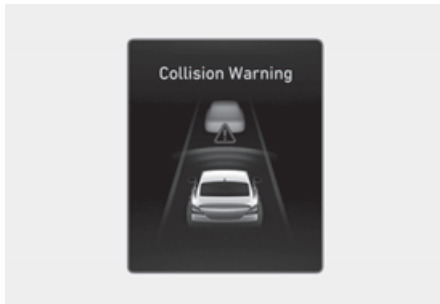

Shooting Brake



To warn the driver of a collision, the “**Collision Warning**” warning message appears, and the  warning light blinks on the instrument cluster with a warning sound and the steering wheel vibrates (if equipped).

- If a vehicle or powered two-wheeler is detected in front, the function will operate when your vehicle speed is between about 10-200 km/h (6-124 mph).
- If a pedestrian or cyclist is detected in front, the function operates when your vehicle speed is between about 10-85 km/h (6-53 mph).

Emergency Braking

Sedan

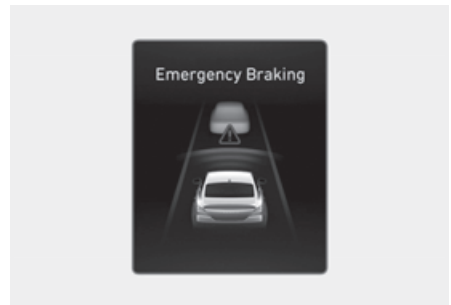

Shooting Brake

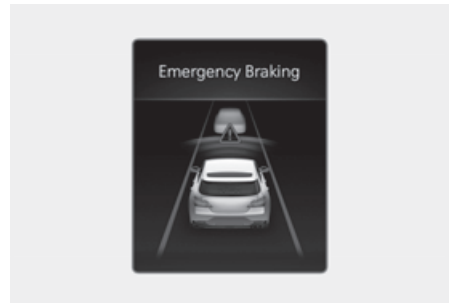

To warn the driver that emergency braking will be assisted, the “**Emergency Braking**” warning message appears and the  warning light blinks on the cluster with a warning sound and the steering wheel vibrates (if equipped).

Emergency braking will operate under the following conditions.

- Vehicle or powered two-wheeler:

	Driving vehicle	Stopped vehicle
Weak braking power	About 10-200 km/h (6-124 mph)	
Strong braking power	About 10-130 km/h (6-81 mph)	About 10-75 km/h (6-47 mph)

- Pedestrian or cyclist:

The function will operate when your vehicle speed is between about 10-65 km/h (6-40 mph).

⚠ WARNING

- The operating speed range may be limited depending on the state of the vehicle in front or the surroundings.
- During night driving, detection of powered two-wheelers may degrade and Forward Collision-Avoidance Assist may not operate properly or be temporarily limited.

Stopping vehicle and ending brake control

Sedan



Shooting Brake

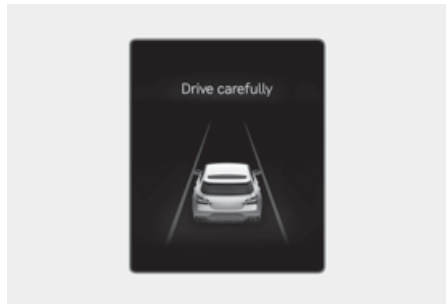

- When the vehicle is stopped due to emergency braking, the “**Drive carefully**” warning message will appear on the cluster.

For your safety, the driver should depress the brake pedal immediately and check the surroundings.

- Brake control will end after the vehicle is stopped by emergency braking for about 2 seconds.

Junction Turning function

Junction Turning function will warn and help control the vehicle depending on the collision risk level: “Collision Warning”, “Emergency Braking” and “Stopping vehicle and ending brake control”.

Collision Warning

Sedan



Shooting Brake



To warn the driver of a collision, the “**Collision Warning**” warning message appears and the  warning light blinks on the cluster with a warning sound and the steering wheel vibrates (if equipped).

- The function will operate when your vehicle speed is between about 10-30 km/h (6-19 mph) and the oncoming vehicle, powered two-wheeler speed is between about 30-70 km/h (19-44 mph).

Emergency Braking

Sedan

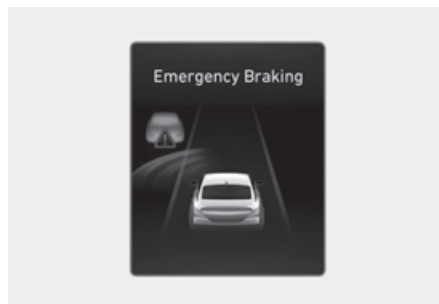

Shooting Brake

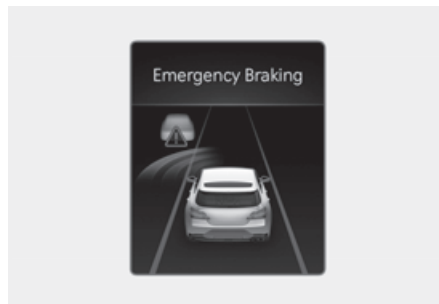

To warn the driver that emergency braking will be assisted, the “**Emergency Braking**” warning message appears and the  warning light blinks on the cluster with a warning sound and the steering wheel vibrates (if equipped).

In emergency braking situation, braking is assisted with strong braking power to help prevent collision with the oncoming vehicle.

- The function will operate when your vehicle speed is between about 10-30 km/h (6-19 mph) and the oncoming vehicle, powered two-wheeler speed is between about 30-70 km/h (19-44 mph).

i Information

If the driver's seat is on the left side, Junction Turning function will operate only when you turn left. If the driver's seat position is on the right side, the function will operate only when you turn right.

Stopping vehicle and ending brake control

Sedan



Shooting Brake

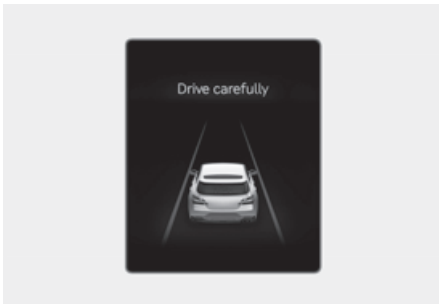

- When the vehicle is stopped due to emergency braking, the **"Drive carefully"** warning message will appear on the cluster.

For your safety, the driver should depress the brake pedal immediately and check the surroundings.

- Brake control will end after the vehicle is stopped by emergency braking for about 2 seconds.

i Information

When a collision warning is being issued or emergency braking is being engaged, press the hazard warning flasher button to turn off the warning sound.

Direct Oncoming function

Direct Oncoming function will warn and control the vehicle depending on the collision risk level: "Collision Warning", "Emergency Braking" and "Stopping vehicle and ending brake control".

Collision Warning

Sedan



Shooting Brake



To warn the driver of a collision, the **"Collision Warning"** warning message appears and the  warning light blinks on the cluster with a warning sound and the steering wheel vibrates (if equipped).

- The function will operate when your vehicle speed is about 30-130 km/h (19-80 mph) and the oncoming vehicle or powered two-wheeler speed is above about 10 km/h (6 mph).

Emergency Braking

Sedan

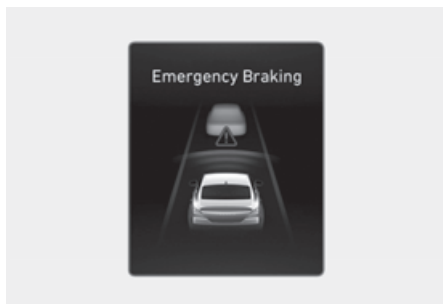

Shooting Brake

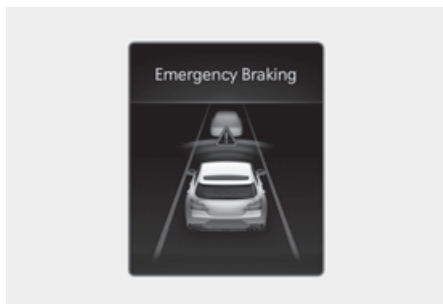

To warn the driver that emergency braking will be assisted, the “**Emergency Braking**” warning message appears and the  warning light blinks on the cluster with a warning sound and the steering wheel vibrates (if equipped).

In emergency braking situation, braking is assisted with strong braking power to help prevent collision with the oncoming vehicle.

- The function will operate when your vehicle speed is about 30-130 km/h (19-80 mph) and the oncoming vehicle or powered two-wheeler speed is above about 10 km/h (6 mph).

Stopping vehicle and ending brake control

Sedan



Shooting Brake

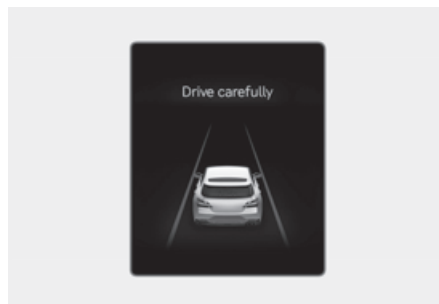

- When the vehicle is stopped due to emergency braking, the “**Drive carefully**” warning message will appear on the cluster.

For your safety, the driver should depress the brake pedal immediately and check the surroundings.

- Brake control will end after the vehicle is stopped by emergency braking for about 2 seconds.

 **CAUTION**

- If your vehicle or the oncoming vehicle is not driving straight, the Direct Oncoming function warning and control may be late or may not operate.
- When driving at night, the powered two-wheeler recognition performance is degraded, so Forward Collision-Avoidance Assist may be temporarily limited or may not work.

 **Information**

When a collision warning is being issued or emergency braking is being engaged, press the hazard warning flasher button to turn off the warning sound.

 **WARNING**

- For your safety, only change the Settings after parking the vehicle at a safe location.
- Forward Collision-Avoidance Assist does not operate in all situations and cannot avoid all collisions.
- The driver has the responsibility to control the vehicle. Do not solely depend on Forward Collision-Avoidance Assist. Rather, maintain a safe braking distance, and if necessary, depress the brake pedal to reduce driving speed or to stop the vehicle.
- Never deliberately operate Forward Collision-Avoidance Assist on people, objects, etc. It may cause serious injury or death.
- Forward Collision-Avoidance Assist may not operate if the driver depresses the brake pedal to avoid collision.

- During Forward Collision-Avoidance Assist operation, the vehicle may stop suddenly injuring passengers and shifting loose objects. Always have the seat belt on and keep loose objects secured.
 - If any other system's warning message appears or audible warning is generated, Forward Collision-Avoidance Assist warning message may not be displayed and audible warning may not be generated.
 - You may not hear the warning sound of Forward Collision-Avoidance Assist if the surrounding is noisy.
 - Forward Collision-Avoidance Assist may turn off or may not operate properly or may operate unnecessarily depending on the road conditions and the surroundings.
 - Even if there is a problem with Forward Collision-Avoidance Assist, the vehicle's basic braking performance will operate properly.
 - During emergency braking, braking control by Forward Collision-Avoidance Assist will automatically cancel when the driver excessively depresses the accelerator pedal or sharply steers the vehicle.
-

⚠ CAUTION

- Depending on the condition of the vehicle, powered two-wheeler, and pedestrian and cyclist in front and the surroundings, the speed range to operate Forward Collision-Avoidance Assist may reduce. Forward Collision-Avoidance Assist may only warn the driver, or it may not operate.
- Forward Collision-Avoidance Assist will operate under certain conditions by judging the risk level based on the condition of the oncoming vehicle or powered two-wheeler, driving direction, speed and surroundings.
- Only Forward Collision-Avoidance Assist warning and collision mitigation are possible depending on the detectable distance.

i Information

- In a situation where collision is imminent, braking may be assisted by Forward Collision-Avoidance Assist when braking is insufficient by the driver.
- The images and colors in the instrument cluster may differ depending on the cluster type or theme selected from the settings menu.

Forward Collision-Avoidance Assist malfunction and limitations

Forward Collision-Avoidance Assist malfunction

Type A

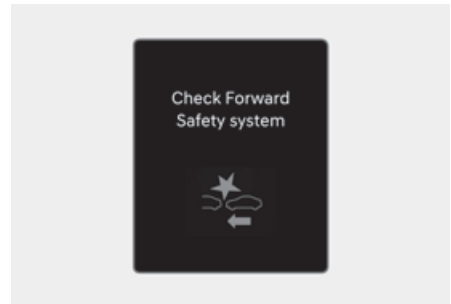

Type B

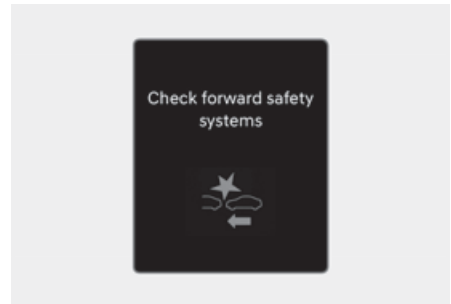

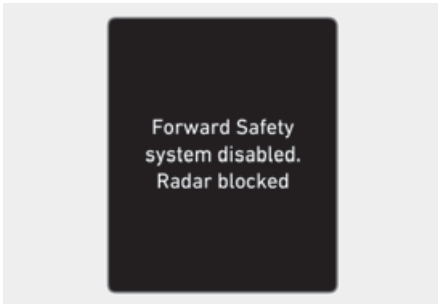
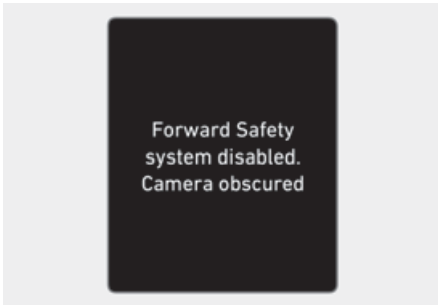

When Forward Collision-Avoidance Assist is not working properly, the “**Check Forward Safety system**” (or “**Check forward safety systems**”) warning message will appear, and the ⚠ and 🚗 warning lights will illuminate on the cluster. We recommend that the vehicle be inspected by an authorized retailer of Genesis Branded products.

Forward Collision-Avoidance Assist disabled



When the front windshield where the front view camera is located, front radar cover, or sensor is covered with foreign material, such as snow, rain or fog, it can reduce the detecting performance and temporarily limit or disable Forward Collision-Avoidance Assist.

If this occurs the **“Forward Safety system disabled. Camera obscured”** or the **“Forward Safety system disabled. Radar blocked”** warning message, and the  and  warning lights will illuminate on the cluster.

Forward Collision-Avoidance Assist will operate properly when snow, rain or foreign material is removed.

If Forward Collision-Avoidance Assist does not operate properly after obstruction (snow, rain, or foreign material) is removed (including trailer, carrier, etc., from the rear bumper), we recommend that the vehicle be inspected by an authorized retailer of Genesis Branded products.

WARNING

- Even though the warning message or warning light does not appear on the cluster, Forward Collision-Avoidance Assist may not properly operate.
- Forward Collision-Avoidance Assist may not properly operate in an area (for example, open terrain), where any objects are not detected after turning ON the engine.
- If the vehicle is restarted when the sensors are disabled or malfunctioned, Forward Collision-Avoidance Assist may not operate properly.

Limitations of Forward Collision-Avoidance Assist

Forward Collision-Avoidance Assist may not operate properly, or it may operate unexpectedly under the following circumstances:

- The detecting sensor or the surroundings are contaminated or damaged
- The temperature around the front view camera is high or low due to surrounding environment
- The camera lens is contaminated due to tinted, filmed or coated windshield, damaged glass, or sticky foreign material (sticker, bug, etc.) on the glass
- Moisture is not removed or frozen on the windshield
- Washer fluid is continuously sprayed, or the wiper is on
- Driving in heavy rain or snow, or thick fog
- The field of view of the front view camera is obstructed by sun glare
- Street light or light from an oncoming traffic is reflected on the wet road surface, such as a puddle on the road
- An object is placed on the dashboard
- Your vehicle is being towed
- The surrounding is very bright
- The surrounding is very dark, such as in a tunnel, etc.
- The brightness changes suddenly, for example when entering or exiting a tunnel
- The brightness outside is low, and the headlights are not on or are not bright
- Driving through steam, smoke or shadow
- Only part of the vehicle, powered two-wheeler, and pedestrian or cyclist is detected
- The vehicle in front is a bus, heavy truck, truck with an unusually shaped cargo, trailer, etc.
- The vehicle and powered two-wheeler in front has no tail lights, tail lights are located unusually, etc.
- The brightness outside is low, and the tail lights are not on or are not bright
- The rear of the front vehicle and powered two-wheeler is small or the vehicle and powered two-wheeler does not look normal, such as when the vehicle is tilted, overturned, or the side of the vehicle is visible, etc.
- The front vehicle's ground clearance is low or high
- A vehicle and powered two-wheeler, and pedestrian or cyclist suddenly cuts in front
- The bumper around the front radar is impacted, damaged or the front radar is out of position
- The temperature around the front radar is high or low
- Driving through a tunnel or iron bridge
- Driving in vast areas where there are few vehicles or structures (for example, desert, meadow, suburb, etc.)
- Driving near areas containing metal substances, such as a construction zone, railroad, etc.
- A material is near that reflects very well on the front radar, such as a guardrail, nearby vehicle, etc.
- The cyclist in front is on a bicycle made of material that does not reflect on the front radar
- The vehicle and powered two-wheeler in front is detected late
- The vehicle and powered two-wheeler in front is suddenly blocked by an obstacle
- The vehicle and powered two-wheeler in front suddenly changes lane or suddenly reduces speed
- The vehicle and powered two-wheeler in front is bent out of shape

- The front vehicle and powered two-wheeler speed is fast or slow
- The vehicle and powered two-wheeler in front is covered with snow
- You are departing or returning to the lane
- Unstable driving
- You are on a roundabout and the vehicle in front is not detected
- You are continuously driving in a circle
- The vehicle and powered two-wheeler in front has an unusual shape
- The vehicle and powered two-wheeler in front is driving uphill or downhill
- The pedestrian or cyclist is not fully detected, for example, if the pedestrian is leaning over or is not fully walking upright
- The pedestrian or cyclist is wearing clothing or equipment that makes it difficult to detect



The illustration above shows the image the front view camera and front radar are capable of detecting as a vehicle, powered two-wheeler, and pedestrian and cyclist.

- The pedestrian or cyclist in front is moving intersected with the driving direction
 - There is a group of pedestrians, cyclists or a large crowd in front
 - The pedestrian or cyclist is wearing clothing that easily blends into the background, making it difficult to detect
 - The pedestrian or cyclist is difficult to distinguish from the similarly shaped structure in the surroundings
 - You are driving by a pedestrian, cyclist, traffic signs, structures, etc., near the intersection
 - Driving in a parking lot
 - Driving through a tollgate, construction area, unpaved road, partial paved road, uneven road, speed bumps, etc.
 - Driving on an incline road, curved road, etc.
 - Driving through a roadside with trees or streetlights
 - The adverse road conditions cause excessive vehicle vibrations while driving
 - Your vehicle height is low or high due to heavy loads, abnormal tire pressure, etc.
 - Driving through a narrow road where trees or grass are overgrown
 - There is interference by electromagnetic waves, such as driving in an area with strong radio waves or electrical noise
- The pedestrian or cyclist in front is moving very quickly
 - The pedestrian or cyclist in front is short or is posing a low posture
 - The pedestrian or cyclist in front has impaired mobility

⚠ WARNING

• Driving on a curved road

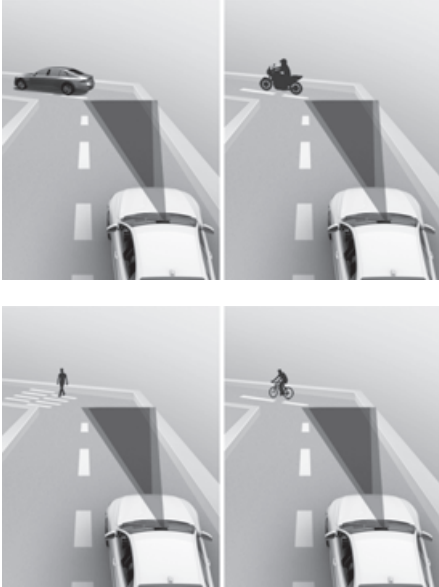

Forward Collision-Avoidance Assist may not detect a vehicle, a powered two-wheeler, and a pedestrian or a cyclist in front of you when driving on curved roads adversely affecting the performance of the sensors. This may result in no warning, braking assist when necessary.

When driving on a curve, you must maintain a safe braking distance, and if necessary, depress the brake pedal to reduce your driving speed in order to maintain a safe distance.

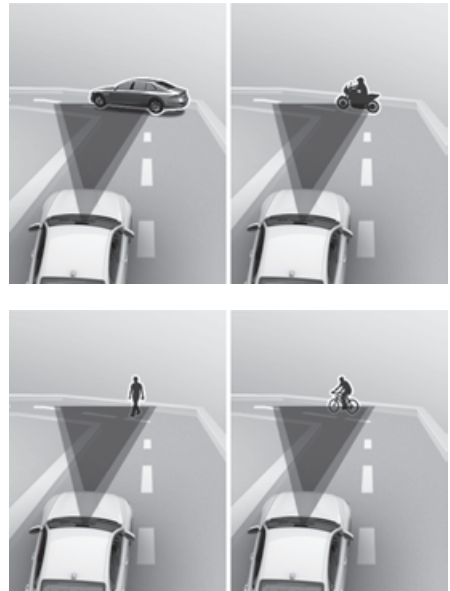

Forward Collision-Avoidance Assist may detect a vehicle, powered two-wheeler, and pedestrian or cyclist in the next lane or outside the lane when driving on a curved road.

If this occurs, Forward Collision-Avoidance Assist may unnecessarily warn the driver and control the brake. Always check the traffic conditions around the vehicle.

• **Driving on an inclined road**



Forward Collision-Avoidance Assist may not detect a vehicle, a powered two-wheeler, and a pedestrian or a cyclist in front of you while driving uphill or downhill, adversely affecting the performance of the sensors.

This may result in unnecessary warning, braking assist or no warning, braking assist when necessary.

Also, vehicle speed may rapidly decrease when vehicle, powered two-wheeler, and pedestrian or cyclist ahead is suddenly detected.

Always have your eyes on the road while driving uphill or downhill and if necessary, steer your vehicle and depress the brake pedal to reduce your driving speed in order to maintain a safe distance.

- Changing lanes



- [A] Your vehicle
 [B] Lane changing vehicle or powered-two wheeler

When a vehicle moves into your lane from an adjacent lane, it cannot be detected by the sensor until it is in the sensor's detection range. Forward Collision-Avoidance Assist may not immediately detect the vehicle when the vehicle changes lanes abruptly. In this case, you must maintain a safe braking distance, and if necessary, steer your vehicle and depress the brake pedal to reduce your driving speed in order to maintain a safe distance.



- [A] Your vehicle
 [B] Lane changing vehicle
 [C] Same lane vehicle or powered two-wheeler

When a vehicle in front of you merges out of the lane, Forward Collision-Avoidance Assist may not immediately detect the vehicle or powered two-wheeler that is now in front of you. In this case, you must maintain a safe braking distance, and if necessary, steer your vehicle and depress the brake pedal to reduce your driving speed in order to maintain a safe distance.

• **Detecting vehicle**

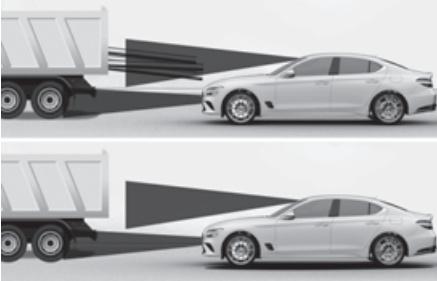

If the vehicle in front of you has cargo that extends rearward from the cab, or when the vehicle in front of you has higher ground clearance, additional special attention is required. Forward Collision-Avoidance Assist may not be able to detect the cargo extending from the vehicle. In these instances, you must maintain a safe braking distance from the rearmost object, and if necessary, steer your vehicle and depress the brake pedal to reduce your driving speed in order to maintain distance.

! WARNING

- When you are towing a trailer or another vehicle, turn off Forward Collision-Avoidance Assist for safety reasons.
 - Forward Collision-Avoidance Assist may operate if objects that are similar in shape or characteristics to vehicles, powered two-wheeler, pedestrians and cyclists are detected.
 - Forward Collision-Avoidance Assist does not operate on bicycles, or smaller wheeled objects, such as luggage bags, shopping carts, or strollers.
 - Forward Collision-Avoidance Assist may not operate properly if interfered by strong electromagnetic waves.
 - Forward Collision-Avoidance Assist may not operate for about 15 seconds after the vehicle is started, or the front view camera is initialized.
-

Lane Keeping Assist (LKA)

 if equipped

While driving over a certain speed, Lane Keeping Assist detects lane markings (or road edges) and may warn you if your vehicle leaves the lane without using the turn signal and may assist with steering to prevent your vehicle departing from its travel lane.

Detecting sensor



(1) Front view camera

The front view camera is used as a detecting sensor to detect lane markings (or road edges).

See the illustration above for the detailed location of the detecting sensor.

CAUTION

For more information on the precautions of the front view camera, refer to the “Forward Collision-Avoidance Assist (FCA) (Sensor fusion)” section in this chapter.

Lane Keeping Assist settings

Lane Safety

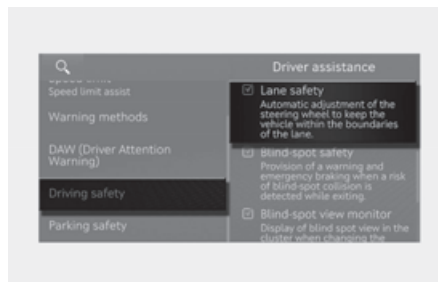

With the engine on, select **Setup (Settings) > Vehicle > Driver assistance > Driving safety > Lane safety** from the settings menu in the infotainment system to set whether to use each function.

If “**Lane safety**” is selected, Lane Keeping Assist automatically assists the driver’s steering when lane departure is detected to help prevent the vehicle from moving out of its lane. If “**Lane safety**” is deselected, Lane Keeping Assist turns off, and the yellow  indicator light turns on on the cluster.

WARNING

- Lane Keeping Assist does not control the steering wheel when the vehicle is driven in the middle of the lane.
- The driver should always be aware of the surroundings. If “**Lane safety**” is deselected, Lane Keeping Assist cannot assist you.

Information

The infotainment system may change after software updates. For more information, refer to the manual provided in the infotainment system and the quick reference guide.

Warning methods

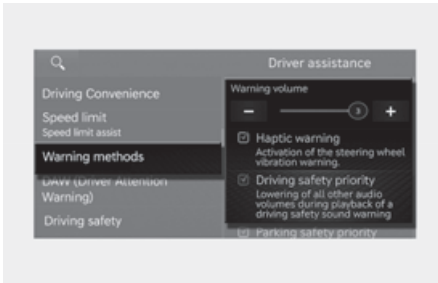

The Warning methods can be set with the engine on.

- **Warning volume:** Select **Setup (Settings) > Vehicle > Driver assistance > Warning methods > Warning volume** from the settings menu in the infotainment system to change the warning volume.
- **Haptic warning:** Select **Settings > Vehicle > Driver assistance > Warning methods > Haptic warning** from the settings menu in the infotainment system to set haptic warning (if equipped).
- **Driving safety priority:** Select **Settings > Vehicle > Driver assistance > Warning methods > Driving safety priority** from the settings menu in the infotainment system.

If “**Driving safety priority**” is selected, the vehicle lowers all other audio volumes when the warning sounds for safe driving.

i Information

The infotainment system may change after software updates. For more information, refer to the manual provided in the infotainment system and the quick reference guide.







i Information

- If you change the Warning methods, the Warning methods of other Driver assistance systems may change.
- The **Warning volume** and **Haptic warning** cannot be turned off at the same time. When one of the warning is turned off the other is activated.
- If the engine is restarted, Warning methods will maintain the last setting.
- The setting menu may not exist depending on the vehicle specification.



Lane Keeping Assist operation

Turning Lane Keeping Assist On/Off



- For Europe
Whenever the vehicle is turned on, Lane Keeping Assist will always turn on. The grey or green  indicator light will illuminate on the cluster. When Lane Keeping Assist is on, press and hold the Lane Driving Assist () button to turn off the function. The  indicator turns yellow when Lane Keeping Assist is off.
- Except Europe
With the engine on, press and hold the Lane Driving Assist () button located on the steering wheel to turn on and off. When Lane Keeping Assist is on, the grey or green  indicator will illuminate on the cluster. The  indicator turns yellow when Lane Keeping Assist is off.

Information

- When Lane Keeping Assist is ready to operate, the  indicator turns grey on the cluster.
- When Lane Keeping Assist is operating, the  indicator turns green on the cluster.

Warning and control

Lane Keeping Assist will warn and help control the vehicle with Lane Departure Warning and Lane Keeping Assist.

Sedan - Left

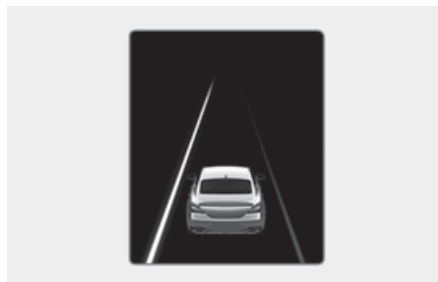

Sedan - Right

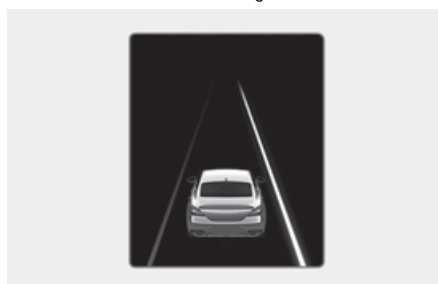

Shooting Brake - Left

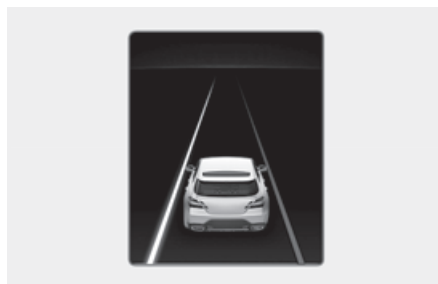

Shooting Brake - Right

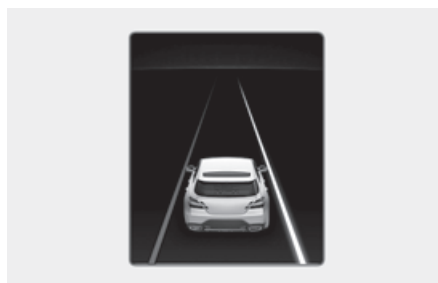

Lane Departure Warning

- To warn the driver that the vehicle is departing from the projected lane in front, the green  indicator light will blink on the cluster, the lane line will blink on the cluster depending on which direction the vehicle is veering, and an audible warning will sound. Also, the steering wheel vibrates (if equipped).
- Lane Keeping Assist will operate when your vehicle speed is about 60-200 km/h (40-120 mph).

Lane Keeping Assist

- To warn the driver that the vehicle is departing from the projected lane in front, the green  indicator light will blink on the cluster, and the steering wheel will make adjustments to keep vehicle inside the lane.
- Lane Keeping Assist will operate when your vehicle speed is about 60-200 km/h (40-120 mph).

Hands-off warning

Type A

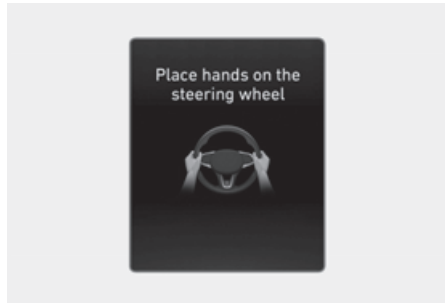

Type B

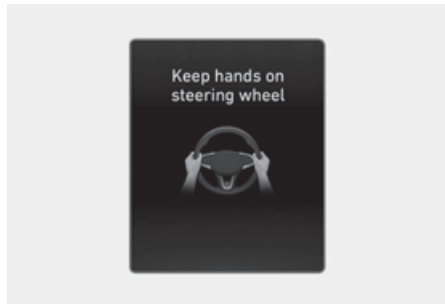

If the driver takes their hands off the steering wheel for several seconds, the **“Place hands on the steering wheel”** (or **“Keep hands on the steering wheel”**) warning message appears on the cluster, and an audible warning sounds in stages.

WARNING

- The steering wheel may not be assisted if the steering wheel is held very tight or the steering wheel is steered over a certain degree.
- Lane Keeping Assist does not operate at all times. It is the responsibility of the driver to safely steer the vehicle and to maintain the vehicle in its lane.
- The hands-off warning message may appear late depending on road conditions. Always have your hands on the steering wheel while driving.
- If the steering wheel is held very lightly, the hands-off warning message may appear because Lane Keeping Assist may not recognize that the driver has their hands on the steering wheel.
- If you attach objects to the steering wheel, the hands-off warning may not work properly.

i Information

- For more information on instrument cluster settings, refer to the "Cluster display (Type A), Cluster display (Type B)" section in chapter 4.
- When lane markings (or road edges) are detected, the lane lines on the cluster will change from grey to white and the green  indicator light will illuminate.

Sedan - Lane undetected

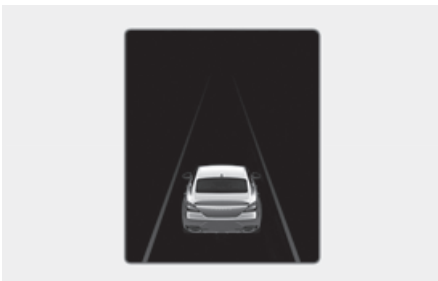

Sedan - Lane detected



Shooting Brake - Lane undetected

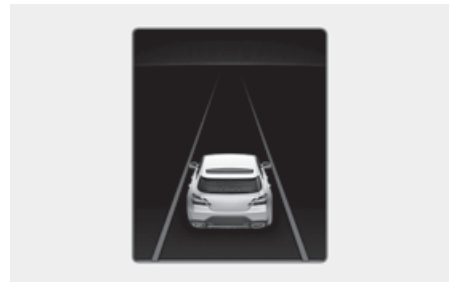

Shooting Brake - Lane detected



- The images and colors in the cluster may differ depending on the cluster type or theme selected from the cluster.
- Even though the steering is assisted by Lane Keeping Assist, the driver may control the steering wheel.
- The steering wheel may feel heavier or lighter when the steering wheel is assisted by Lane Keeping Assist than when it is not.

Lane Keeping Assist malfunction and limitations

Lane Keeping Assist malfunction

Type A

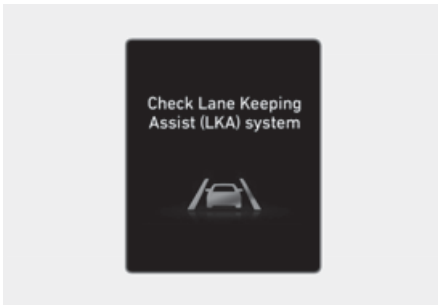

Type B

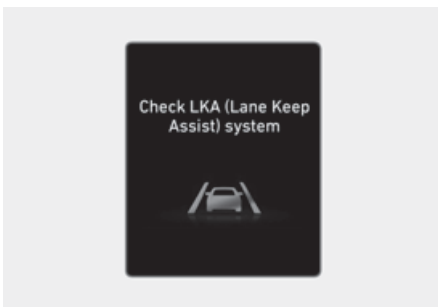

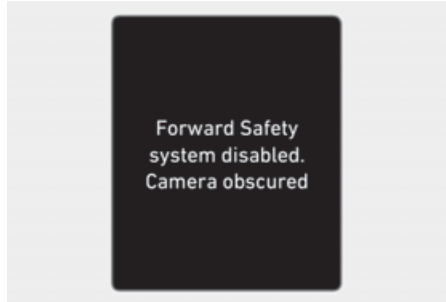

When Lane Keeping Assist is not working properly, the “**Check Lane Keeping Assist (LKA) system**” (or “**Check LKA (Lane Keeping Assist) system**”) warning message will appear and the yellow  indicator light will illuminate on the cluster. If this occurs, we recommend that the vehicle be inspected by an authorized retailer of Genesis Branded products.

Lane Keeping Assist disabled



When the front windshield where the front view camera is located, or sensor is covered with foreign material, such as snow or rain, it can reduce the detecting performance and temporarily limit or disable Lane Keeping Assist.

If this occurs, the “**Forward Safety system disabled. Camera obscured**” warning message and the master  warning light or Lane Keeping Assist  warning light appears on the instrument cluster.

Lane Keeping Assist operates properly when snow, rain or foreign material is removed.

If Lane Keeping Assist does not operate properly after it is removed, we recommend that your vehicle be inspected by an authorized retailer of Genesis Branded products.

WARNING

- Even though the warning message does not appear on the cluster, Lane Keeping Assist may not properly operate.
- If the vehicle is turned off and restarted while the camera is blocked or malfunctioned, the condition is maintained. Therefore, Lane Keeping Assist may not operate properly.

Limitations of Lane Keeping Assist

Lane Keeping Assist may not operate properly or may operate unexpectedly under the following circumstances:

- The lane is contaminated or difficult to detect because:
 - The lane markings (or road edge) are covered with rain, snow, dirt, oil, etc.
 - The color of the lane marking (or road edge) is not distinguishable from the road
 - There are markings (or road edges) on the road near the lane or the markings (or road edges) on the road look similar to the lane markings (or road edge)
 - The lane marking (or road edge) is indistinct or damaged
 - The shadow is on the lane marking (or road edge) by a median strip, trees, guardrail, noise barriers, etc.
- The lane number increases or decreases, or the lane markings (or road edges) are crossing
- There are more than two lane markings (or road edges) on the road
- The lane markings (or road edges) are complicated or a structure substitutes for the lines, such as a construction area
- There are road markings, such as zigzag lanes, crosswalk markings and road signs
- The lane suddenly disappears, such as at the intersection
- The lane (or road width) is very wide or narrow
- There is a road edge without a lane
- There is a boundary structure in the roadway, such as a tollgate, sidewalk, curb, etc.
- The distance to the front vehicle is extremely short or the vehicle in front is covering the lane marking (or road edge)

i Information

For more information on the limitations of the front view camera, refer to the “Forward Collision-Avoidance Assist (FCA) (Sensor fusion)” section in this chapter.

⚠ WARNING

Take the following precautions when using Lane Keeping Assist:

- The driver has the responsibility to safely drive and control the vehicle. Do not solely rely on Lane Keeping Assist and drive dangerously.
- The operation of Lane Keeping Assist can be cancelled or not work properly depending on road conditions and surroundings. Always be cautious while driving.
- Refer to the “Lane Keeping Assist malfunction and limitations” if the lane is not detected properly.
- When you are towing a trailer or another vehicle, turn off Lane Keeping Assist for safety reasons.
- If the vehicle is driven at high speed, the steering wheel will not be controlled. The driver must always follow the speed limit when using Lane Keeping Assist.
- If any other system’s warning message appears or audible warning is generated, Lane Keeping Assist warning message may not be displayed and audible warning may not be generated.
- You may not hear the warning sound of Lane Keeping Assist if the surrounding is noisy.
- If you attach objects to the steering wheel, steering may not be assisted properly.

- Lane Keeping Assist may not operate for 15 seconds after the vehicle is started, or the front view camera is initialized.
 - Lane Keeping Assist will not operate when:
 - Within a certain period of time after turning on or off the turn signal or hazard warning flasher.
 - The vehicle is not driven in the center of the lane when Lane Keeping Assist is turned on or right after changing a lane.
 - ESC (Electronic Stability Control) or VSM (Vehicle Stability Management) is activated.
 - The vehicle is driven on a sharp curve.
 - Vehicle speed is below 55 km/h (35 mph) or above 210 km/h (130 mph).
 - The vehicle makes sudden lane changes.
 - The vehicle brakes suddenly.
-

Blind-Spot Collision-Avoidance Assist (BCA)

 If equipped

Blind-Spot Collision-Avoidance Assist detects approaching vehicles in the driver's blind spot areas and warn you of a possible collision with a warning light and a warning sound.

If there is a collision risk when exiting a parallel space, Blind-Spot Collision-Avoidance Assist may assist with braking your vehicle to help avoid a collision.

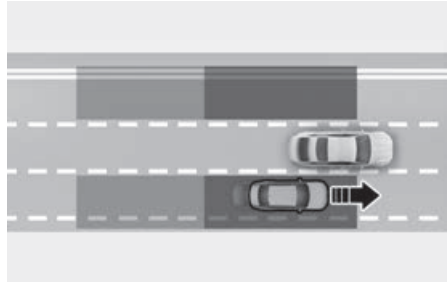

Blind-Spot Collision-Avoidance Assist helps detect and informs the driver that a vehicle is in the blind spot.

CAUTION

The detecting range may vary depending on the speed of your vehicle. Even if there is a vehicle in the blind spot area, Blind-Spot Collision-Avoidance Assist may not warn you when you pass by at high speeds.

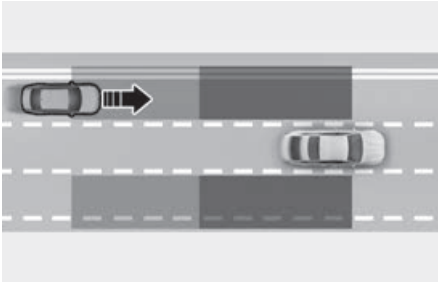

Blind-Spot Collision-Avoidance Assist helps detect and informs the driver that a vehicle is approaching at high speed from the blind spot area.

CAUTION

Warning timing may vary depending on the speed of the vehicle approaching at high speed.

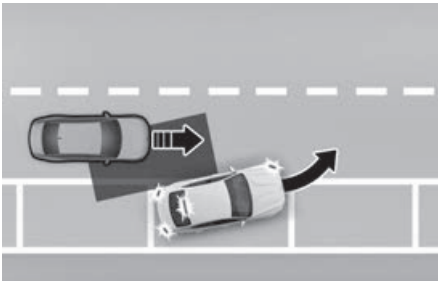

When you are driving forward out of a parking space, if Blind-Spot Collision-Avoidance Assist judges that there is a collision risk with an approaching vehicle in the blind spot, it can help avoid collision by applying the brake.

Detecting sensor

Sedan



Shooting Brake



(1) Rear corner radar

See the illustration above for the detailed location of the detecting sensors.

⚠ CAUTION

Take the following precautions to maintain optimal performance of the detecting sensor:

- Never disassemble the detecting sensor assembly, or cause any damage to it.
- If the rear corner radar or near the radar has been damaged or impacted in any way, even though the warning message does not appear on the cluster, Blind-Spot Collision-Avoidance Assist may not operate properly. We recommend that the vehicle be inspected by an authorized retailer of Genesis Branded products.
- If the rear corner radars have been replaced or repaired, we recommend that the vehicle be inspected by an authorized retailer of Genesis Branded products.
- Use only genuine parts to repair the rear bumper where the rear corner radar is located.
- Rear bumper genuine parts with rear corner radars have proven their performance. Replacing or painting the rear bumper may result in poor performance of Blind-Spot Collision-Avoidance Assist. When the parts need to be replaced or modified, make sure to use qualified products.
- Do not apply license plate frame or objects, such as a bumper sticker, film or a bumper guard near the rear corner radar.
- Blind-Spot Collision-Avoidance Assist may not work properly if the bumper has been replaced, or the surroundings of the rear corner radar have been damaged or paint has been applied.
- If a trailer, carrier, etc., is installed, it may adversely affect the performance of the rear corner radar or Blind-Spot Collision-Avoidance Assist may not operate.

Blind-Spot Collision-Avoidance Assist settings

Blind-spot safety



With the engine on, select **Setup (Settings) > Vehicle > Driver assistance > Driving safety > Blind-spot safety** in the infotainment system to set whether to use each function.

- If “**Blind-spot safety**” is selected, Blind-Spot Collision-Avoidance Assist will warn the driver with a warning message, an audible warning depending on the collision risk levels. Braking assist will be applied for parking exits depending on the collision risk levels.

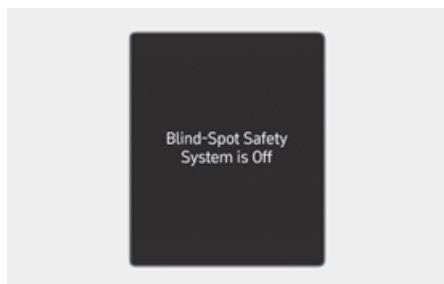

When the vehicle is restarted with Blind-Spot Collision-Avoidance Assist off, the “**Blind-Spot Safety System is Off**” message will appear on the instrument cluster.

If you select “**Blind-spot safety**”, warning light on the outside rearview mirror will blink for three seconds. In addition, if the vehicle is turned on, when “**Blind-spot safety**” is selected, the warning light on the outside rearview mirror will blink for 3 seconds.

WARNING

The driver should always be aware of the surroundings and drive safely. If “**Blind-spot safety**” is deselected, Blind-spot Collision-Avoidance Assist cannot assist you.

i Information

- If the vehicle is restarted, Blind-Spot Collision-Avoidance Assist will maintain the last setting.
- The infotainment system may change after software updates. For more information, refer to the manual provided in the infotainment system and the quick reference guide.

Warning methods



The Warning methods can be set with the engine on.

- **Warning volume:** Select **Setup (Settings) > Vehicle > Driver assistance > Warning methods > Warning volume** from the settings menu in the infotainment system to change the warning volume.

- **Haptic warning:** Select **Settings > Vehicle > Driver assistance > Warning methods > Haptic warning** from the settings menu in the infotainment system to set haptic warning (if equipped).
- **Driving safety priority:** Select **Settings > Vehicle > Driver assistance > Warning methods > Driving safety priority** from the settings menu in the infotainment system.

If “**Driving safety priority**” is selected, the vehicle lowers all other audio volumes when the warning sounds for safe driving.

i Information

The infotainment system may change after software updates. For more information, refer to the manual provided in the infotainment system and the quick reference guide.

i Information

- If you change the Warning methods, the Warning methods of other Driver assistance systems may change.
- The **Warning volume** and **Haptic warning** cannot be turned off at the same time. When one of the warning is turned off the other is activated.
- If the engine is restarted, Warning methods will maintain the last setting.
- The setting menu may not exist depending on the vehicle specification.

Blind-Spot Collision-Avoidance Assist operation

Collision warning

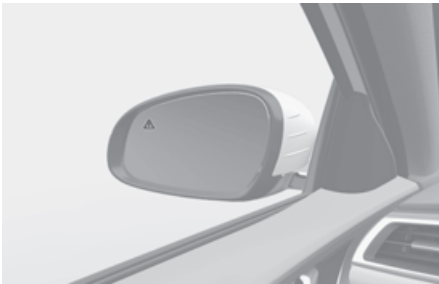

To warn the driver a vehicle is detected, the warning light on the outside rearview mirror illuminates.

Vehicle detection operates under following conditions.

- Your vehicle speed: above 20 km/h (12 mph)
- Speed of the vehicle in the blind spot area: above 10 km/h (7 mph)

Collision warning operates when the turn signal is turned on in the direction of the detected vehicle.

- To warn the driver of a collision, the warning light on the outside rearview mirror and head-up display (if equipped) blinks. At the same time, an audible warning sounds and the steering wheel vibrates (if equipped).
- When the turn signal is turned off or you move away from the lane, the collision warning will be cancelled and Blind-Spot Collision-Avoidance Assist will return to vehicle detection state.

Collision warning operates under following conditions.

- Your vehicle speed: above 40 km/h (25 mph)
- Speed of the vehicle in the blind spot area: above 10 km/h (7 mph)

WARNING

- The detecting range of the rear corner radar is determined by a standard road width, therefore, on a narrow road, Blind-Spot Collision-Avoidance Assist may detect other vehicles two lanes over and warn you. In contrast, on a wide road, Blind-Spot Collision-Avoidance Assist may not be able to detect a vehicle driving in the next lane and may not warn you.
- When the hazard warning flasher is on, the collision warning by the turn signal will not operate.

Information

If the driver's seat is on the left side, the collision warning may occur when you turn left. Maintain a proper distance from the vehicles in the left lane. If the driver's seat is on the right side, the collision warning may occur when you turn right. Maintain a proper distance from the vehicles in the right lane.

The images and colours in the instrument cluster may differ depending on the cluster type or theme selected from the settings menu.

Collision-avoidance assist (while parallel parking exit)

Sedan



Shooting Brake



Sedan



Shooting Brake

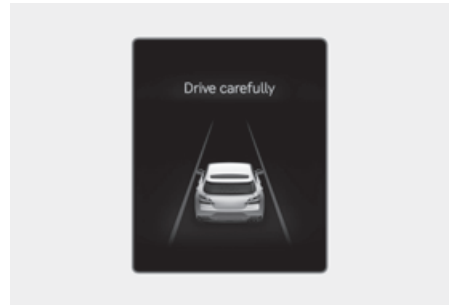

- To warn the driver of a collision, the warning light on the outside rearview mirror will blink and a warning message will appear on the instrument cluster. At the same time, an audible warning will sound, warning light on the head-up display (if equipped) will blink and the steering wheel will vibrate (if equipped).
- Emergency braking will be assisted to help prevent collision with the vehicle in the blind spot area.
- Blind-Spot Collision-Avoidance Assist will operate when your vehicle speed is below 3 km/h (2 mph) and the speed of the vehicle in the blind spot area is above 5 km/h (3 mph).

- When the vehicle is stopped due to emergency braking, the “**Drive carefully**” warning message will appear on the cluster.

For your safety, the driver should depress the brake pedal immediately and check the surroundings.

- Brake control will end after the vehicle is stopped by emergency braking for about 2 seconds.

! WARNING

Take the following precautions when using Blind-Spot Collision-Avoidance Assist:

- For your safety, only change the Settings after parking the vehicle at a safe location.
- If any other system's warning message appears or audible warning is generated, Blind-Spot Collision-Avoidance Assist's warning message may not be displayed and audible warning may not be generated.
- You may not hear the warning sound of Blind-Spot Collision-Avoidance Assist if the surrounding is noisy.
- Blind-Spot Collision-Avoidance Assist may not operate if the driver applies the brake pedal to avoid a collision.
- When Blind-Spot Collision-Avoidance Assist is operating, braking control by the function will automatically cancel when the driver excessively depresses the accelerator pedal or sharply steers the vehicle.
- During Blind-Spot Collision-Avoidance Assist operation, the vehicle may stop suddenly injuring passengers and shifting loose objects. Always have the seat belt on and keep loose objects secured.
- Blind-Spot Collision-Avoidance Assist does not operate in all situations and cannot avoid all collisions.
- Blind-Spot Collision-Avoidance Assist may warn the driver late or may not warn the driver depending on the road and driving conditions.
- Driver should maintain control of the vehicle at all times. Do not depend on Blind-Spot Collision-Avoidance Assist. Maintain a safe braking distance, and if necessary, depress the brake pedal to reduce driving speed or to stop the vehicle.

- Never operate Blind-Spot Collision-Avoidance Assist on people, animal, objects, etc. It may cause serious injury or death.

! WARNING

The brake control may not operate properly depending on the status of ESC (Electronic Stability Control).

There will only be a warning when:

- The ESC (Electronic Stability Control) warning light is on
- ESC (Electronic Stability Control) is engaged in a different function

Blind-Spot Collision-Avoidance Assist malfunction and limitations

Blind-Spot Collision-Avoidance Assist malfunction

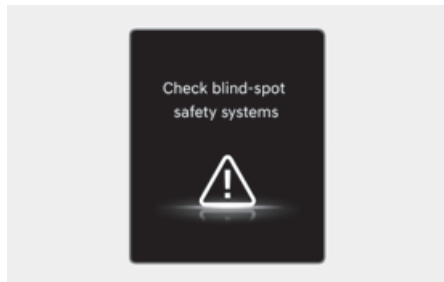

When Blind-Spot Collision-Avoidance Assist is not working properly, the **“Check Blind-Spot Safety system”** warning message will appear on the cluster for several seconds, and the master (▲) warning light will illuminate on the cluster. If this occurs, we recommend that the vehicle be inspected by an authorized retailer of Genesis Branded products.

Type A

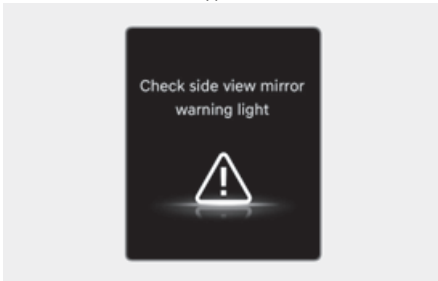

Type B

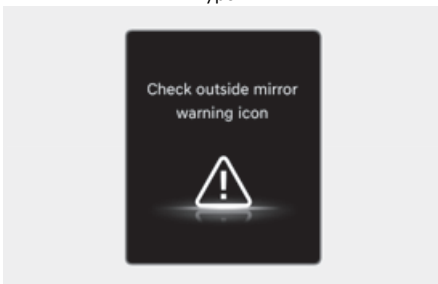

When the outside rearview mirror warning light is not working properly, the **“Check side view mirror warning light”** (or **“Check outside mirror warning icon”**) warning message will appear on the cluster for several seconds, and the master (⚠) warning light will illuminate on the cluster. If this occurs, we recommend that the vehicle be inspected by an authorized retailer of Genesis Branded products.

Blind-Spot Collision-Avoidance Assist disabled



When the rear bumper around the rear corner radar or sensor is covered with foreign material, such as snow or rain, or installing a trailer or carrier, it can reduce the detecting performance and temporarily limit or disable Blind-Spot Collision-Avoidance Assist.

If this occurs, the **“Blind-Spot Safety system disabled. Radar blocked”** warning message will appear on the cluster.

Blind-Spot Collision-Avoidance Assist will operate properly when such foreign material or trailer, etc., is removed, and then the vehicle is restarted.

If Blind-Spot Collision-Avoidance Assist does not operate properly after it is removed, we recommend that the vehicle be inspected by an authorized retailer of Genesis Branded products.

 **WARNING**

- Even though the warning message does not appear on the cluster, Blind-Spot Collision-Avoidance Assist may not properly operate.
- Blind-Spot Collision-Avoidance Assist may not properly operate in an area (for example, open terrain) where any objects are not detected right after the vehicle is turned on, or when the detecting sensor is blocked with foreign material right after the vehicle is turned on.

 **CAUTION**

Turn off Blind-Spot Collision-Avoidance Assist to install or remove a trailer, carrier, or another attachment. Turn on Blind-Spot Collision-Avoidance Assist when finished.

Limitations of Blind-Spot Collision-Avoidance Assist

Blind-Spot Collision-Avoidance Assist may not operate properly, or it may operate unexpectedly under the following circumstances:

- There is inclement weather, such as heavy snow, heavy rain, etc.
- The rear corner radar is covered with snow, rain, dirt, etc.
- The temperature around the rear corner radar is high or low
- Driving on a highway ramp
- The road pavement (or the peripheral ground) abnormally contains metallic components (for example, possibly due to subway construction)
- There is a fixed object near the vehicle, such as sound barriers, guardrails, central dividers, entry barriers, street lamps, signs, tunnels, walls, etc. (including double structures)
- Driving in vast areas where there are few vehicles or structures (for example, desert, meadow, suburb, etc.)
- Driving through a narrow road where trees or grass are overgrown
- Driving on a wet road surface, such as a puddle on the road
- The other vehicle drives very close behind your vehicle, or the other vehicle passes by your vehicle in close proximity
- The speed of the other vehicle is very fast that it passes by your vehicle in a short time
- Your vehicle passes by the other vehicle
- Your vehicle changes lane
- Your vehicle has started at the same time as the vehicle next to you and has accelerated
- The vehicle in the next lane moves two lanes away from you, or when the vehicle two lanes away moves to the next lane from you
- A trailer, carrier or other attachment is installed around the rear corner radar
- The bumper around the rear corner radar is covered with objects, such as a bumper sticker, bumper guard, bike rack, etc.
- The bumper around the rear corner radar is impacted, damaged or the radar is out of position
- Your vehicle height is low or high due to heavy loads, abnormal tire pressure, etc.

- Blind-Spot Collision-Avoidance Assist may not operate properly, or it may operate unexpectedly when the following objects are detected:
 - A motorcycle or bicycle is detected
 - A vehicle such as a flat trailer is detected
 - A big vehicle such as a bus or truck is detected
 - A moving obstacle such as a pedestrian, animal, shopping cart or a baby stroller is detected
 - A vehicle with low height such as a sports car is detected

Braking control may not work, driver's attention is required in the following circumstances:

- The vehicle severely vibrates while driving over a bumpy road, uneven road or concrete patch
- Driving on a slippery surface due to snow, water puddle, ice, etc.
- The tire pressure is low or a tire is damaged
- The braking system has been modified
- The vehicle makes abrupt lane changes

i Information

For more information on the limitations of the front view camera, refer to the "Forward Collision-Avoidance Assist (FCA) (Sensor fusion)" and "Lane Keeping Assist (LKA)" section in this chapter.

WARNING

- **Driving on a curved road**



Blind-Spot Collision-Avoidance Assist may not operate properly when driving on a curved road. The function may not detect the vehicle in the next lane.

Always pay attention to road and driving conditions while driving.

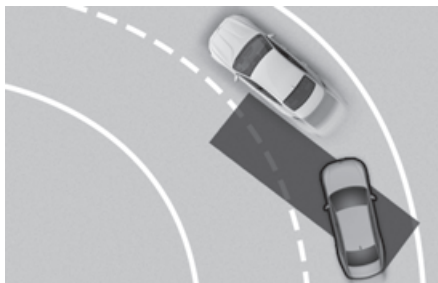

Blind-Spot Collision-Avoidance Assist may not operate properly when driving on a curved road. The function may recognize a vehicle in the same lane.

Always pay attention to road and driving conditions while driving.

- **Driving on an inclined road**

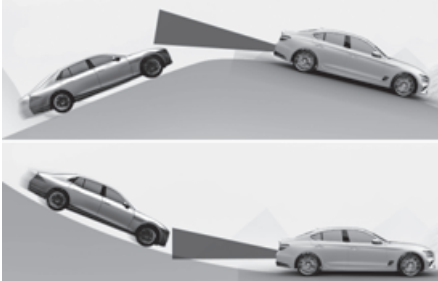

Blind-Spot Collision-Avoidance Assist may not operate properly when driving on a slope. The function may not detect the vehicle in the next lane or may incorrectly detect the ground or structure.

Always pay attention to road and driving conditions while driving.

- **Driving where the road is merging/dividing**

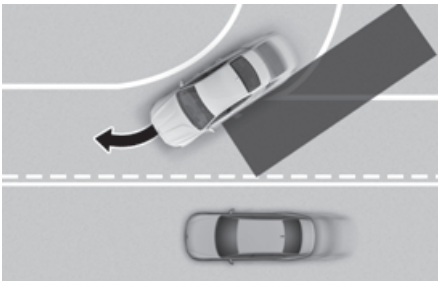

Blind-Spot Collision-Avoidance Assist may not operate properly when driving where the road merges or divides. The function may not detect the vehicle in the next lane.

Always pay attention to road and driving conditions while driving.

- Driving where the heights of the lanes are different

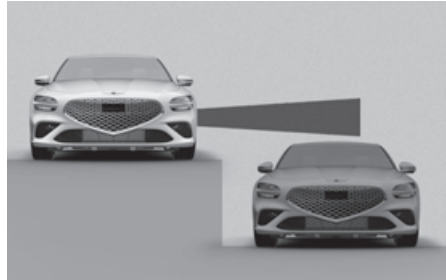

Blind-Spot Collision-Avoidance Assist may not operate properly when driving where the heights of the lanes are different. The function may not detect the vehicle on a road with different lane heights (underpass joining section, grade separated intersections, etc.).

Always pay attention to road and driving conditions while driving.

⚠ WARNING

- When you are towing a trailer or another vehicle, make sure that you turn off Blind-Spot Collision-Avoidance Assist.
 - Blind-Spot Collision-Avoidance Assist may not operate properly if interfered by strong electromagnetic waves.
 - Blind-Spot Collision-Avoidance Assist may not operate for 3 seconds after the vehicle is started, or the front view camera or rear corner radars are initialized.
-

Safe Exit Warning (SEW)

 if equipped

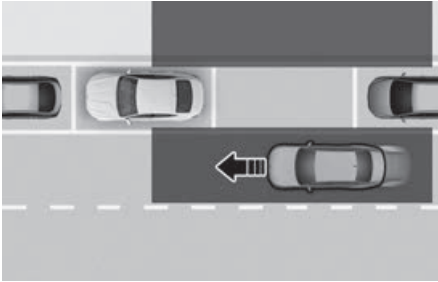

While your vehicle is stopped, and if Safe Exit Warning detects a vehicle approaching the rear corner of your vehicle and a passenger opens a door, Safe Exit Warning may warn you with a warning message and a warning sound to help avoid a collision.

CAUTION

Warning timing may vary depending on the speed of the approaching vehicle.

Detecting sensor

Sedan



Shooting Brake



(1) Rear corner radar

See the illustration above for the detailed location of the detecting sensors.

CAUTION

For more information on the precautions of the rear corner radars, refer to the “Blind-Spot Collision-Avoidance Assist (BCA)” section in this chapter.

Safe Exit Warning settings

Safe Exit Warning



With the engine on, select **Setup (Settings) > Vehicle > Driver assistance > Driving safety > Exit safety** in the infotainment system to set whether to use each function.

WARNING

The driver should always be aware of his or her surroundings. If **“Exit safety”** is deselected, Safe Exit Warning cannot assist you.

Information

- If the engine is restarted, Safe Exit Warning will maintain the last setting.
- The infotainment system may change after software updates. For more information, refer to the manual provided in the infotainment system and the quick reference guide.

Warning methods



The Warning methods can be set with the engine on.

- **Warning volume:** Select **Setup (Settings) > Vehicle > Driver assistance > Warning methods > Warning volume** from the settings menu in the infotainment system to change the warning volume.

If you turn off the **Warning volume**, for your safety, the function may warn you with a low volume (if equipped).

- **Driving safety priority:** Select **Setup (Settings) > Vehicle > Driver assistance > Warning methods > Driving safety priority** from the settings menu in the infotainment system.

If **“Driving safety priority”** is selected, the vehicle lowers all other audio volumes when the warning sounds for safe driving.

i Information

- If you change the Warning methods, the Warning methods of other Driver assistance systems may change.
- If the engine is restarted, Warning methods will maintain the last setting.
- The setting menu may not exist depending on the vehicle specification.
- The infotainment system may change after software updates. For more information, refer to the manual provided in the infotainment system and the quick reference guide.

Safe Exit Warning operation

Safe Exit Warning

Collision warning when exiting vehicle



Sedan

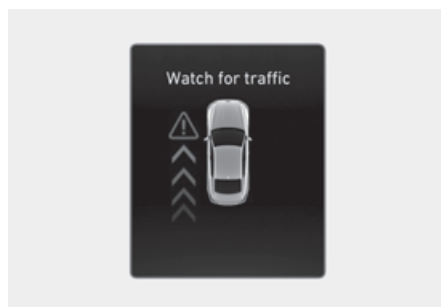

Shooting Brake

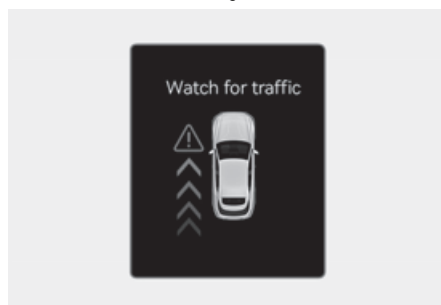

- When an approaching vehicle from the rear is detected at the moment a door is opened, the **“Watch for traffic”** warning message will appear on the cluster, and an audible warning will sound.

- Safe Exit Warning will warn the driver when your vehicle speed is below 3 km/h (2 mph), and the speed of the approaching vehicle from the rear is above 6 km/h (4 mph).

WARNING

Take the following precautions when using Safe Exit Warning:

- For your safety, change the Settings after parking the vehicle at a safe location.
 - If any other system's warning message appears or audible warning is generated, Safe Exit Warning's warning message may not be displayed and audible warning may not be generated.
 - You may not hear the warning sound of Safe Exit Warning if the surrounding is noisy.
 - Safe Exit Warning does not operate in all situations and cannot prevent all collisions.
 - Safe Exit Warning may warn the driver late or may not warn the driver depending on the road and driving conditions. Always check vehicle surroundings.
 - The driver and passengers are responsible for accidents that occur while exiting the vehicle. Always check the surroundings before you exit the vehicle.
 - Never deliberately operate Safe Exit Warning. Doing so may lead to serious injury or death.
-
- Safe Exit Warning does not operate if there is a problem with Blind-Spot Collision-Avoidance Assist. The warning message of Blind-Spot Collision-Avoidance Assist will appear when:
 - Blind-Spot Collision-Avoidance Assist sensor or the sensor surrounding is polluted or covered
 - Blind-Spot Collision-Avoidance Assist fails to warn passengers or falsely warn passengers
-

i **Information**

- After the vehicle is turned off, Safe Exit Warning operates for about 3 minutes, but turns off immediately if the doors are locked.
 - The images and colors in the instrument cluster may differ depending on the instrument cluster type or theme selected from the instrument cluster.
-

Safe Exit Warning malfunction and limitations

Safe Exit Warning malfunction

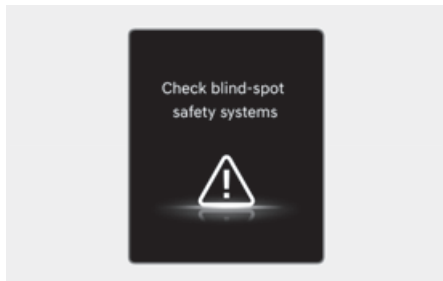

When Safe Exit Warning is not working properly, the “**Check Blind-Spot Safety system**” warning message will appear on the cluster for several seconds, and the master (⚠) warning light will illuminate on the cluster. If this occurs, we recommend that the vehicle be inspected by an authorized retailer of Genesis Branded products.

Type A

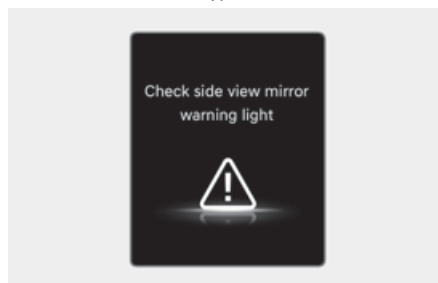

Type B

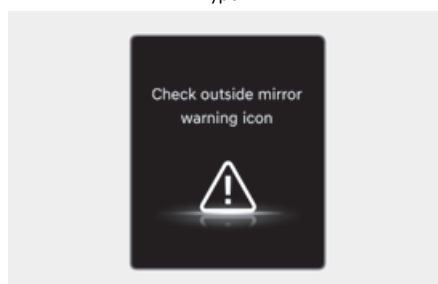

When the outside rearview mirror warning light is not working properly, the “**Check side view mirror warning light**” (or “**Check outside mirror warning icon**”) warning message will appear on the cluster for several seconds, and the master (⚠) warning light will illuminate on the cluster. If this occurs, we recommend that the vehicle be inspected by an authorized retailer of Genesis Branded products.

Safe Exit Warning disabled

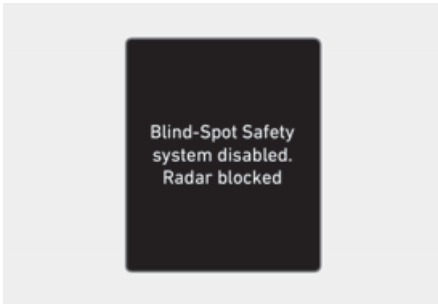

When the rear bumper around the rear corner radar or sensor is covered with foreign material, such as snow or rain, or installing a trailer or carrier, it can reduce the detecting performance and temporarily limit or disable Safe Exit Warning.

If this occurs, the **“Blind-Spot Safety system disabled. Radar blocked”** warning message will appear on the cluster.

Safe Exit Warning will operate properly when such foreign material or trailer, etc., is removed, and then the vehicle is restarted.

If Safe Exit Warning does not operate properly after it is removed, we recommend that the vehicle be inspected by an authorized retailer of Genesis Branded products.

WARNING

- Even though the warning message does not appear on the cluster, Safe Exit Warning may not properly operate.
- Safe Exit Warning may not properly operate in an area (for example, open terrain) where any objects are not detected right after the vehicle is turned on, or when the detecting sensor is blocked with foreign material right after the vehicle is turned on.

CAUTION

Turn off Safe Exit Warning to install or remove a trailer, carrier, or another attachment. Turn on Safe Exit Warning when finished.

Limitations of Safe Exit Warning

Safe Exit Warning may not operate properly, or it may operate unexpectedly under the following circumstances:

- Getting out of the vehicle where trees or grass are overgrown
- Getting out of the vehicle where the road is wet
- The approaching vehicle is very fast or very slow

Information

For more information on the limitations of the rear corner radar, refer to the “Blind-Spot Collision-Avoidance Assist (BCA)” section in this chapter.

WARNING

- Safe Exit Warning may not operate properly if interfered by strong electromagnetic waves.
- Safe Exit Warning may not operate for 3 seconds after the vehicle is started, or the rear corner radars are initialized.
- If the vehicle is turned off and restarted while the radar is blocked or malfunctioned, the condition is maintained. Therefore, Safe Exit Warning may not operate properly.

Manual Speed Limit Assist (MSLA)



- (1) Speed Limit indicator
(2) Set speed

You can set the speed limit when you do not want to drive over a specific speed.

If you drive over the preset speed limit, Manual Speed Limit Assist operates (set speed limit will blink and chime will sound) until the vehicle speed returns within the speed limit.

Manual Speed Limit Assist operation

Setting speed limit

1. Press and hold the Driving Assist (🚗) button at the desired speed. The Speed Limit (🚗LIMIT) indicator will appear on the cluster.

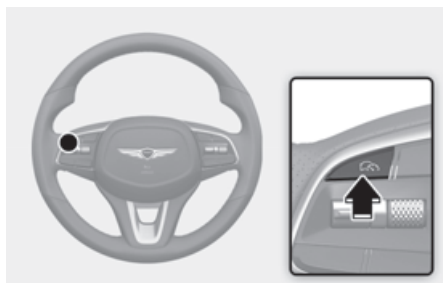

2. Push the + switch up or - switch down, and release it at the desired speed.

Push the + switch up or - switch down and hold it. The speed will increase or decrease to the nearest multiple of 10 (multiple of 5 in mph) at first, and then increase or decrease by 10 km/h (5 mph).

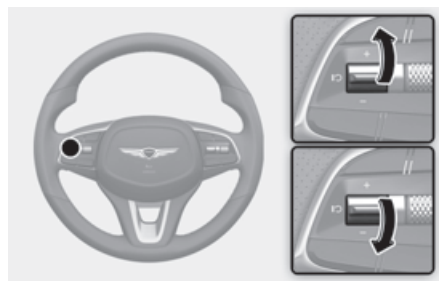

3. The set speed limit appears on the cluster.

If you would like to drive over the preset speed limit, depress the accelerator pedal beyond the pressure point to activate the kickdown function.

The set speed limit will blink and chime will sound until you return the vehicle speed within the speed limit.





i Information

- When the accelerator pedal is not depressed beyond the pressure point, vehicle speed will maintain within the speed limit.
- A clicking sound may be heard from the kickdown function when the accelerator pedal is depressed beyond the pressure point.

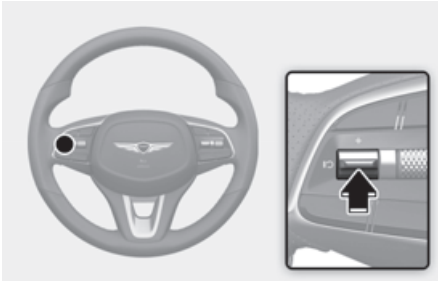
Temporarily pausing Manual Speed Limit Assist



Press the  switch to temporarily pause the set speed limit. The set speed limit will turn off but the Speed Limit () indicator will stay on.

Resuming Manual Speed Limit Assist

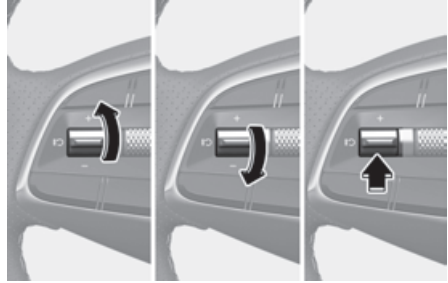



To resume Manual Speed Limit Assist after the function was paused, operate the +, -,  switch.

If you push the + switch up or - switch down, vehicle speed will be set to the current speed on the cluster.

If you press the  switch, vehicle speed will resume to the preset speed.

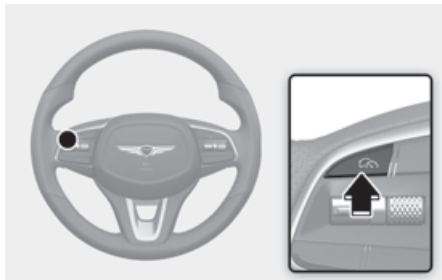
Turning off Manual Speed Limit Assist



Press the Driving Assist () button to turn Manual Speed Limit Assist off. The Speed Limit () indicator will go off.

Always press the Driving Assist () button to turn Manual Speed Limit Assist off when not in use.

WARNING

Take the following precautions when using Manual Speed Limit Assist:

- Always set the vehicle speed to the speed limit in your country.
- Keep Manual Speed Limit Assist off when the function is not in use, to avoid inadvertently setting a speed. Check that the Speed Limit () indicator is off.
- Manual Speed Limit Assist does not substitute for proper and safe driving. It is the responsibility of the driver to always drive safely and be aware of unexpected and sudden situations. Pay attention to the road conditions at all times.

Intelligent Speed Limit Assist (ISLA)

 if equipped

Intelligent Speed Limit Assist uses information from the detected road signs and uses the navigation system data to inform you of the speed limit and to help maintain within the speed limit on the road.

CAUTION

- Intelligent Speed Limit Assist may not operate properly if the function is used in other countries.
- The infotainment system may change after software updates. For more information, refer to the manual provided in the infotainment system and the quick reference guide.

Information

The infotainment system may change after software updates. For more information, refer to the manual provided in the infotainment system and the quick reference guide.

Detecting sensor



(1) Front view camera

See the illustration above for the detailed location of the detecting sensor.

CAUTION

For more information on the precautions of the front view camera, refer to the “Forward Collision-Avoidance Assist (FCA) (Sensor fusion)” section in this chapter.

Intelligent Speed Limit Assist settings

Speed limit

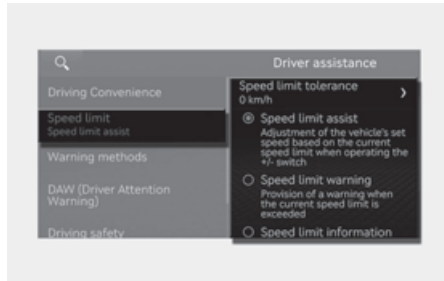

With the engine on, select or deselect **Setup (Settings) > Vehicle > Driver assistance > Speed limit** from the Settings menu to set whether to use each function.

- **Speed limit tolerance:** The Speed Limit Offset can be changed. Speed Limit Warning and Speed Limit Assist will operate by applying the Speed Limit Offset setting to the detected speed limit.
- **Speed limit assist:** Intelligent Speed Limit Assist will inform the driver of speed limit and additional road signs. In addition, Intelligent Speed Limit Assist will inform the driver to change set speed of Manual Speed Limit Assist and/or Smart Cruise Control to help the driver stay within the speed limit.
- **Speed limit warning:** Intelligent Speed Limit Assist will inform the driver of speed limit and additional road signs. In addition, Intelligent Speed Limit Assist will warn the driver when the vehicle is driven faster than the speed limit.
- **Speed limit information:** Intelligent Speed Limit Assist will inform the driver the current speed limit of the road.
- **Off:** Intelligent Speed Limit Assist will turn off. The  warning light appears.

i Information

Settings menus or options may differ according to your country.

WARNING

- For your safety, only change the Settings after parking the vehicle at a safe location.
- Speed Limit Assist function operates based on the Offset setting added to the speed limit. If you want to change the set speed according to the speed limit, adjust the offset to **0**.
- Intelligent Speed Limit Assist does not substitute for proper and safe driving. It is the responsibility of the driver to always drive safely and be aware of unexpected and sudden situations. Pay attention to the road conditions at all times.

i Information

The setting of "Speed Offset" is not reflected in Navigation-based Smart Cruise Control (NSCC).

Warning methods

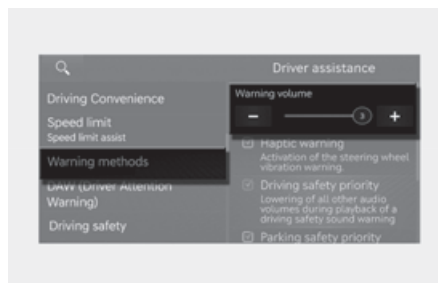

The Warning methods can be set with the engine on.

- **Warning volume:** Select **Setup (Settings) > Vehicle > Driver assistance > Warning methods > Warning volume** from the settings menu in the infotainment system to change the warning volume.

If you turn off the **Warning volume**, for your safety, the function may warn you with a low volume (if equipped).

i Information

- If you change the Warning methods, the Warning methods of other Driver assistance systems may change.
- If the engine is restarted, Warning methods will maintain the last setting.
- The setting menu may not exist depending on the vehicle specification.

Intelligent Speed Limit Assist operation

Warning and control

Intelligent Speed Limit Assist will warn and control the vehicle by “Displaying speed limit”, “Warning overspeed” and “Changing set speed”.

i Information

The warning and control of Intelligent Speed Limit Assist explained below is based on the Speed Limit Offset setting in **0**. For more information on Speed Limit Offset settings, refer to the “Intelligent Speed Limit Assist settings” section.

Displaying speed limit

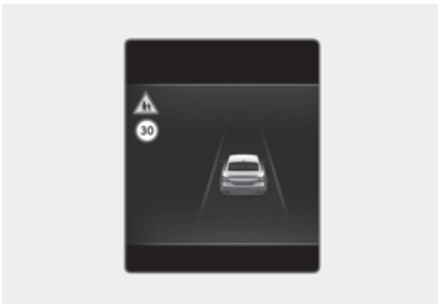

Speed limit information appears on the instrument cluster.

i Information

- If speed limit information of the road cannot be recognized, "---" sign appears. Please refer to the “Limitations of Intelligent Speed Limit Assist” section, if the road signs are difficult to recognize.
- Intelligent Speed Limit Assist provides additional road sign information in addition to speed limit. The additional road sign information provided may vary according to your country.
- Supplementary sign displayed under the speed limit or overtaking restriction sign means the conditions under which the signs must be followed. If the supplementary sign is not recognized, it is displayed as blank.
- The images and colors in the instrument cluster may differ depending on the instrument cluster type or theme selected from the instrument cluster.

Warning overspeed

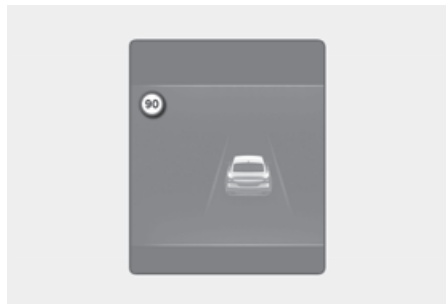

When driving at a speed higher than the displayed speed limit, the red speed limit indicator will blink and warning sounds.

Changing set speed



If the speed limit of the road changes during the operation of Manual Speed Limit Assist or Smart Cruise Control, an arrow in the direction of up or down appears to inform the driver that the set speed needs to be changed. At this time, the driver can change the set speed according to the speed limit by using the + or - switch on the steering wheel.

Set Speed Auto Change (Navigation equipped)

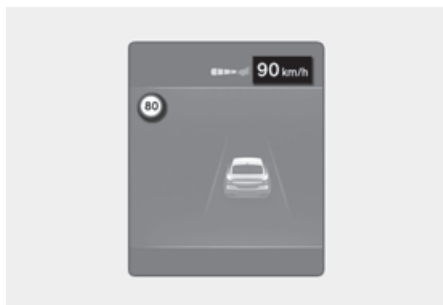

Manual Speed Limit Assist or Smart Cruise Control assists the vehicle to adjust its speed according to the speed limit. When the cruising speed is set as same as the speed limit, the vehicle automatically adjusts its speed if the speed limit changes. The function operates on the road which has a speed limit of 70 km/h (44 mph) or higher. When the function is active, the cruising speed on the instrument cluster appears in green.

! WARNING

- If you want to drive below the speed limit, adjust the Speed Limit Offset below 0 or use the - switch on the steering wheel to lower the set speed.
- Even after changing the set speed according to the speed limit of the road, the vehicle can still be driven over the speed limit. If necessary, depress the brake pedal to reduce your driving speed.
- If the speed limit of the road is under 30 km/h (20 mph), the set speed change function will not work.
- Intelligent Speed Limit Assist operates using the speed units in the instrument cluster set by the driver. If the speed unit is not set to the speed unit used in your country, Intelligent Speed Limit Assist may not operate properly.

i Information

- For more information on Manual Speed Limit Assist operation, refer to the “Manual Speed Limit Assist (MSLA)” section in this chapter.
- For more information on Smart Cruise Control operation, refer to the “Smart Cruise Control (SCC)” section in this chapter.

Intelligent Speed Limit Assist malfunction and limitations

Intelligent Speed Limit Assist malfunction

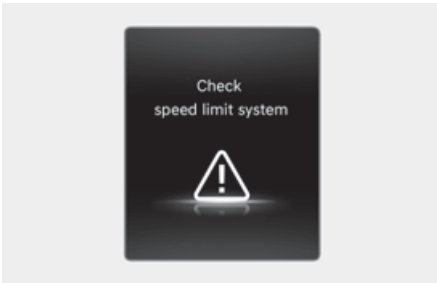

When Intelligent Speed Limit Assist is not working properly, the **“Check speed limit system”** warning message will appear on the cluster for several seconds, and the master (⚠) warning light will illuminate on the cluster. If this occurs, we recommend that the vehicle be inspected by an authorized retailer of Genesis Branded products.

Intelligent Speed Limit Assist disabled

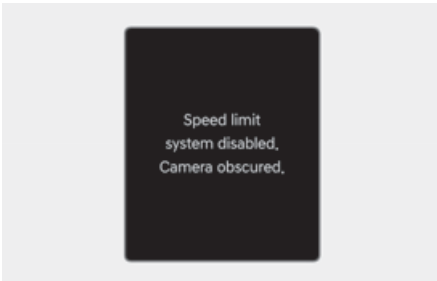

When the front windshield where the front view camera is located is covered with foreign material, such as snow or rain, it can reduce the detecting performance and temporarily limit or disable Intelligent Speed Limit Assist. If this occurs, the **“Speed limit system disabled. Camera obscured”** warning

message and the speed limit (Ⓢ) warning light will appear on the cluster.

Intelligent Speed Limit Assist will operate properly when snow, rain or foreign material is removed.

If Intelligent Speed Limit Assist does not operate properly after it is removed, we recommend that the vehicle be inspected by an authorized retailer of Genesis Branded products.

⚠ WARNING

- Even though the warning message or warning light does not appear on the instrument cluster, Intelligent Speed Limit Assist may not properly operate.
- If the vehicle is turned off and restarted while the camera is blocked or malfunctioned, the condition is maintained. Therefore, Intelligent Speed Limit Assist may not operate properly.

Limitations of Intelligent Speed Limit Assist

Intelligent Speed Limit Assist may not operate properly, or it may operate unexpectedly under the following circumstances:

- The road sign is contaminated or indistinguishable
 - The road sign is difficult to see due to bad weather, such as rain, snow, fog, etc.
 - The road sign is not clear or damaged
 - The road sign is partially obscured by surrounding objects or shadow
- The road signs do not conform to the standard
 - The text or illustration on the road sign is different from the standard
 - The road sign is installed between the main line and the exit road or between diverging roads

- There is no conditional road signs on the road sign located on the exit road
- A sign is attached to another vehicle
- The distance between the vehicle and the road signs is too far
- The vehicle encounters illuminant road signs
- Intelligent Speed Limit Assist incorrectly recognizes numbers or illustrations in the street signs or other signs as the speed limit
- A road sign near the road you are driving is detected
- Multiple signs are installed close together
- The minimum speed limit sign is misrecognized
- The minimum speed limit sign is on the road
- The brightness changes suddenly, for example when entering or exiting a tunnel or passing under a bridge
- Headlights are not used or the brightness of the headlights are weak at night or in the tunnel
- Road signs are difficult to recognize due to the reflection of sunlight, street lights, or oncoming vehicles
- The navigation information or GPS information contain errors.
- The driver does not follow the guide of the navigation.
- The driver is driving on a new road that is not in the navigation system yet.
- The field of view of the front view camera is obstructed by sun glare
- Driving on a road that is sharply curved or continuously curved
- Driving through speed bumps, or driving on steep vertical inclines or roads that are tilted sideways.
- The vehicle is shaking heavily
- Driving on a newly opened road

- The navigation software is being updated while driving
- The navigation is restarted while driving

WARNING

- Intelligent Speed Limit Assist is a supplemental function that helps the driver to comply with the speed limit on the road, and may not display the correct speed limit or control the driving speed properly.
- Always set the vehicle speed to the speed limit in your area.
- Intelligent Speed Limit Assist may not operate for 15 seconds after the vehicle is started, or the front camera is initialized.

i Information

For more information on the limitations of the front view camera, refer to the “Forward Collision-Avoidance Assist (FCA) (Sensor fusion)” section in this chapter.

Driver Attention Warning (DAW)

 If equipped

Basic function

Driver Attention Warning monitors your driving pattern while driving. When the driver's attention level is below a certain level, Driver Attention Warning recommends a break to help with safe driving.

Leading vehicle departure alert function

Leading Vehicle Departure Alert function will inform the driver when a detected vehicle in front departs.

Detecting sensor



(1) Front view camera

The front view camera is used as a detecting sensor to help detect driving patterns and front vehicle departure while vehicle is being driven.

See the illustration above for the detailed location of the detecting sensor.

CAUTION

- Always keep the front view camera in good condition to maintain optimal performance of Driver Attention Warning.
- For more information on the precautions of the front view camera, refer to the “Forward Collision-Avoidance Assist (FCA) (Sensor fusion)” section in this chapter.

Driver Attention Warning settings

Leading vehicle departure alert

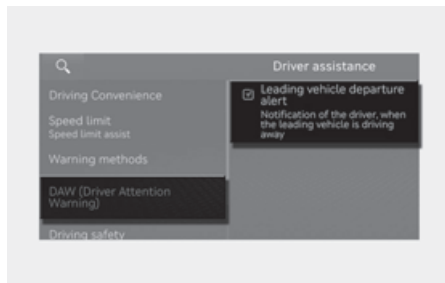

With the engine on, select or deselect **Setup (Settings) > Vehicle > Driver assistance > DAW (Driver Attention Warning)** from the Settings menu to set whether to use each function.

- If **Leading vehicle departure alert** is selected, the function informs the driver when a detected vehicle in front departs from a stop.

Information

The infotainment system may change after software updates. For more information, refer to the manual provided in the infotainment system and the quick reference guide.

Driver Attention Warning operation

Basic function

The basic function of Driver Attention Warning is to warn the driver “**Consider taking a break**”.

Taking a break

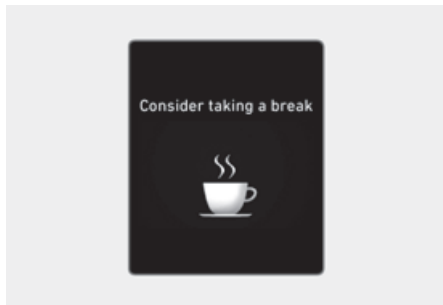

The “**Consider taking a break**” message will appear and the driver’s attention (🚗) warning light will blink on the instrument cluster with a warning sound to suggest that the driver take a break, when the driver’s attention level is below a certain level.

- Driver Attention Warning will not suggest a break when the total driving time is shorter than 4 minutes or 4 minutes has not passed after the last break was suggested.
- The “**Taking a break**” will operate when your vehicle speed is above 0 km/h (0 mph).

⚠ WARNING

For your safety, change the Settings after parking the vehicle at a safe location.

⚠ CAUTION

- Driver Attention Warning may suggest a break depending on the driver’s driving pattern or habits, even if the driver doesn’t feel fatigued.
- Driver Attention Warning is a supplemental function and may not be able to determine whether the driver is inattentive.
- A driver who feels fatigued should take a break at a safe location, even though there is no break suggestion by Driver Attention Warning.

i Information

For more information on instrument cluster settings, refer to the “Cluster display (Type A), Cluster display (Type B)” section in chapter 4.

Leading vehicle departure alert function

Sedan (Type A)

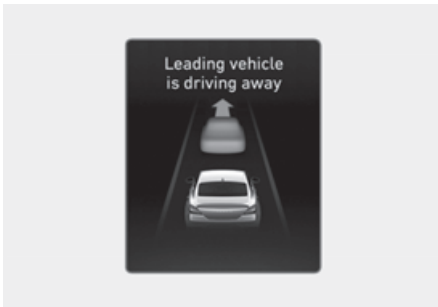

Sedan (Type B)

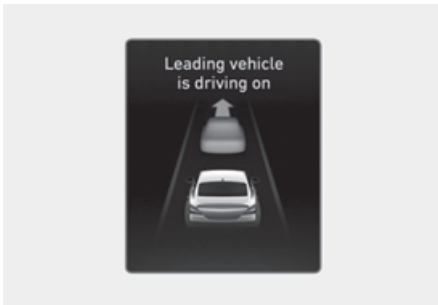

Shooting Brake (Type A)

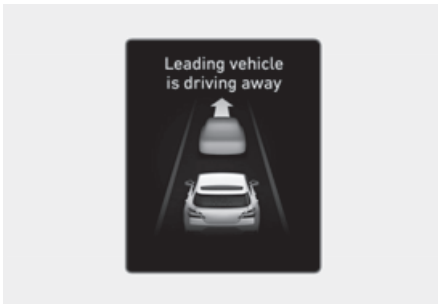

Shooting Brake (Type B)

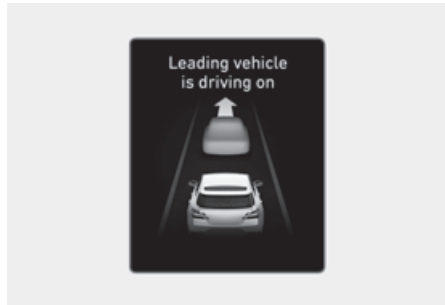

When a detected vehicle in front departs from a stop, Leading Vehicle Departure Alert will inform the driver by displaying the “**Leading vehicle is driving away**” (or “**Leading vehicle is driving on**”) message on the cluster and an audible warning will sound.

WARNING

- If any other system's warning message appears or audible warning is generated, Leading Vehicle Departure Alert's warning message may not be displayed and audible warning may not be generated.
- The driver has the responsibility to safely drive and control the vehicle.

CAUTION

- Leading Vehicle Departure Alert is a supplemental function and may not alert the driver whenever the front vehicle departs from a stop.
- Always check the front of the vehicle and road conditions before departure.

Information

The images and colors in the cluster may differ depending on the cluster type or theme selected from the cluster.

Driver Attention Warning malfunction and limitations

Driver Attention Warning malfunction

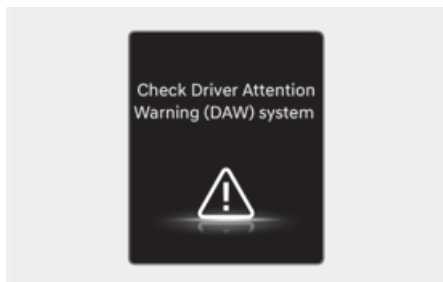

When Driver Attention Warning is not working properly, the “**Check Driver Attention Warning (DAW) system**” warning message will appear on the cluster for several seconds, and the master (⚠) warning light and the driver’s attention (👤) warning light will illuminate on the cluster. If this occurs, we recommend that the vehicle be inspected by an authorized retailer of Genesis Branded products.

Driver Attention Warning disabled

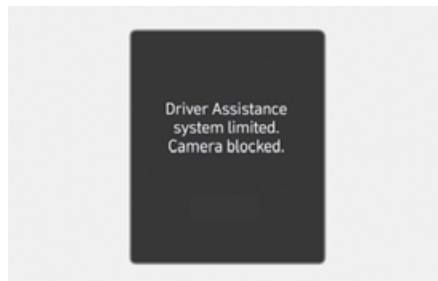

When the front windshield where the front view camera is located is covered with foreign material, such as snow or rain, it can reduce the detecting performance and temporarily limit or disable Driver Attention Warning. If this occurs, the “**Driver Assistance system limited. Camera blocked**” warning message, the master (⚠) warning light, and the driver’s attention (👤) warning light will appear on the instrument cluster. Driver Attention Warning will operate properly when snow, rain or foreign material is removed. If Driver Attention Warning does not operate properly after it is removed, we recommend that the vehicle be inspected by an authorized retailer of Genesis Branded products.

WARNING

- Driver Attention Warning may not properly operate in an area (for example, open terrain) where any objects are not detected right after turning ON the vehicle.
- If the vehicle is turned off and restarted while the camera is blocked or malfunctioned, the condition is maintained. Therefore, Driver Attention Warning may not operate properly.

Limitations of Driver Attention Warning

Driver Attention Warning may not work properly in the following situations:

- The vehicle is driven violently
- The vehicle intentionally crosses over lanes frequently
- The vehicle is controlled by Driver Assistance system, such as Lane Keeping Assist

Leading vehicle departure alert function

• When the vehicle cuts in

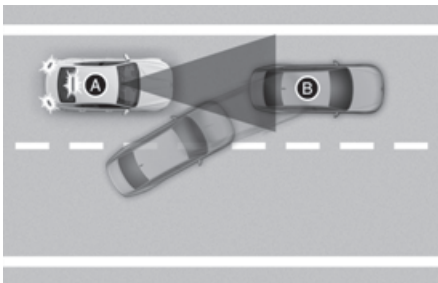
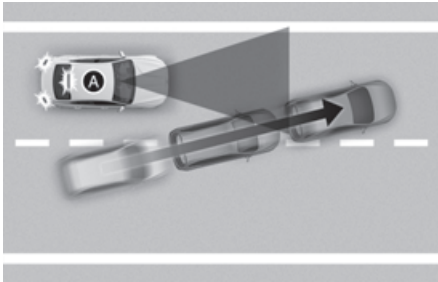

[A] Your vehicle
[B] Front vehicle

If a vehicle cuts in front of your vehicle, Leading Departure Alert may not operate properly.

• When the vehicle ahead sharply steers

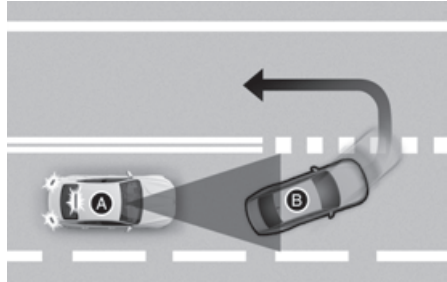

[A] Your vehicle
[B] Front vehicle

If the vehicle in front makes a sharp turn, such as to turn left or right or make a U-turn, etc., Leading Vehicle Departure Alert may not operate properly.

• When the vehicle ahead abruptly departs

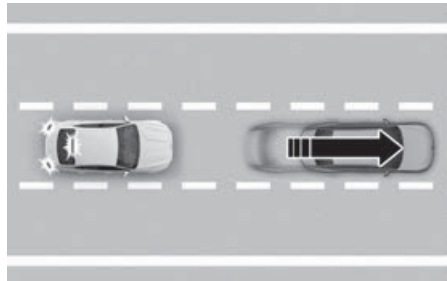

If the vehicle in front abruptly departs, Leading Vehicle Departure Alert may not operate properly.

- When a pedestrian or bicycle is between you and the vehicle ahead



If there is a pedestrian(s) or bicycle(s) in between you and the vehicle in front, Leading Vehicle Departure Alert may not operate properly.

- When in a parking lot

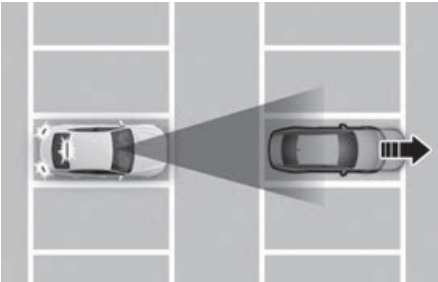

If a vehicle parked in front drives away from you, Leading Vehicle Departure Alert may alert you that the parked vehicle is driving away.

- When driving at a tollgate or intersection, etc.

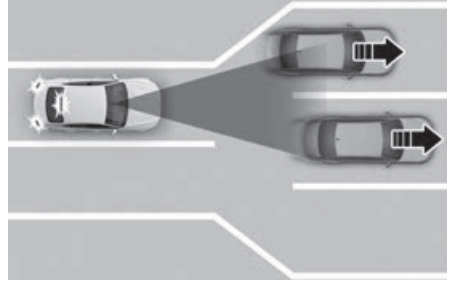

If you pass a tollgate or intersection with lots of vehicles or you drive where lanes are merged or divided frequently, Leading Vehicle Departure Alert may not operate properly.

WARNING

Driver Attention Warning may not operate for about 15 seconds after the vehicle is started, or the front view camera is initialized.

i Information

For more information on the precautions of the front view camera, refer to the “Forward Collision-Avoidance Assist (FCA) (Sensor fusion)” section in this chapter.

Blind-Spot View Monitor (BVM)

 If equipped

Left side

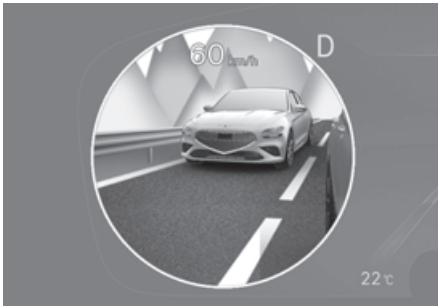

Right side



Blind-Spot View Monitor uses the wide-side view cameras to display the rear blind spot areas of your vehicle on the instrument cluster when the turn signal is turned on to help with safe lane changes.

Detecting sensor



- (1) Wide-side view camera (camera located at bottom of the mirror)
- (2) Wide-side view camera (camera located at bottom of the mirror)

See the illustration above for the detailed location of the detecting sensors.

Blind-Spot View Monitor settings

Blind-spot view monitor

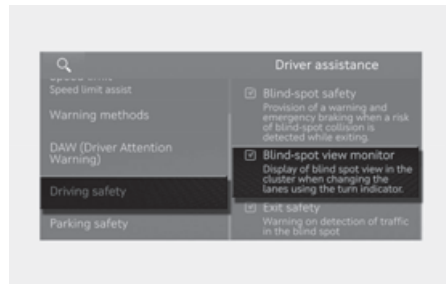

With the engine on, select **Setup (Settings) > Vehicle > Driver assistance > Driving safety** and then enable **Blind-spot view monitor** in the infotainment system to turn on the Blind-Spot View Monitor feature.

i Information

The infotainment system may change after software updates. For more information, refer to the manual provided in the infotainment system and the quick reference guide.

Blind-Spot View Monitor operation

Blind-Spot View Monitor will turn on and off when the turn signal is turned on and off.

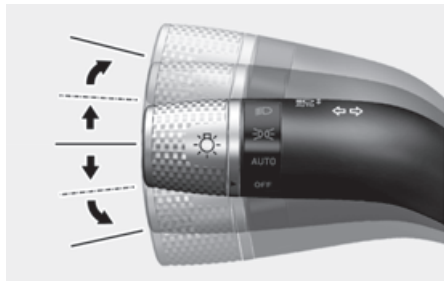

Operating conditions

When the left or right side turn signal turns on, the image in that direction appears on the instrument cluster.

Off conditions

- When the turn signal turns off, the image on the instrument cluster will turn off.
- When the hazard warning flasher is on, Blind-Spot View Monitor will turn off, regardless of the turn signal status.
- When other important warning appears on the instrument cluster, Blind-Spot View Monitor may turn off.

Blind-Spot View Monitor malfunction

When Blind-Spot View Monitor is not working properly, or the cluster display flickers, or the camera image does not display properly, we recommend that the vehicle be inspected by an authorized retailer of Genesis Brand products.

! WARNING

- The image shown on the cluster may differ from the actual distance of the object. Make sure to directly check the vehicle's surroundings for safety.
- Always keep the camera lens clean. If the lens is covered with foreign material, it may adversely affect camera performance and Blind-Spot View Monitor may not operate properly.

Cruise Control (CC)

 if equipped



- (1) Cruise indicator
- (2) Set speed

Cruise Control will allow you to drive at speeds above 30 km/h (20 mph) without depressing the accelerator pedal.

Cruise Control operation

Setting speed

1. Accelerate to the desired speed, which must be more than 30 km/h (20 mph).

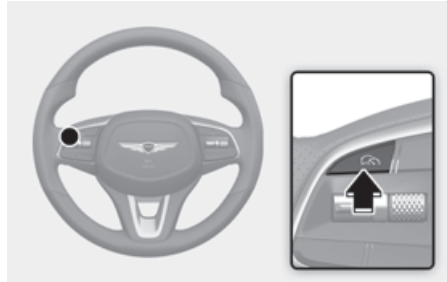

2. Press the Driving Assist button at the desired speed. The set speed and Cruise () indicator will illuminate on the cluster.
3. Release the accelerator pedal.
Vehicle speed will maintain the set speed even when the accelerator pedal is not depressed.

Information

- The vehicle may slightly slow down or speed up while driving uphill or downhill.
- The Driving Assist button symbol may vary depending on your vehicle option.

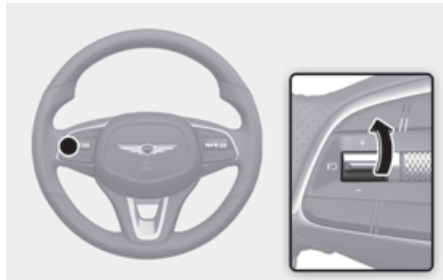
Increasing set speed

- Push the + switch up and release it immediately. The set speed will increase by 1 km/h (1 mph) each time the switch is operated in this manner.
- Push the + switch up and hold it while monitoring the set speed on the cluster. The set speed will increase to the nearest multiple of 10 (multiple of 5 in mph) at first, and then increase by 10 km/h (5 mph) each time the switch is operated in this manner.

Release the switch when the desired speed is shown and the vehicle will accelerate to that speed.

Decreasing set speed

- Push the - switch down and release it immediately. The set speed will decrease by 1 km/h (1 mph) each time the switch is operated in this manner.
- Push the - switch down and hold it while monitoring the set speed on the cluster. The set speed will decrease to the nearest multiple of 10 (multiple of 5 in mph) at first, and then decrease by 10 km/h (5 mph) each time the switch is operated in this manner.

Release the switch at the speed you want to maintain.

Accelerating temporarily

If you want to speed up temporarily when Cruise Control is on, depress the accelerator pedal.

To return to the set speed, take your foot off the accelerator pedal.

If you push the + switch up or - switch down at increased speed, the set speed will be set to the current increased speed.

Temporarily pausing Cruise Control

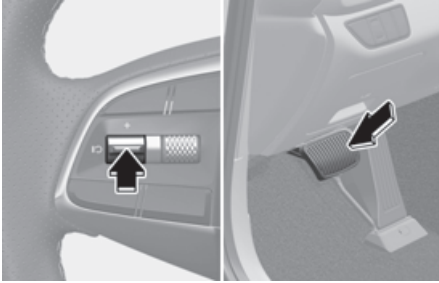

Cruise Control will be paused when:

- Depressing the brake pedal.
- Pressing the **CC** switch.
- Shifting the gear to N (Neutral).
- Decreasing vehicle speed to less than about 30 km/h (20 mph).
- ESC (Electronic Stability Control) is operating.
- Downshifting to 2nd gear when in Manual Shift mode.

The set speed will turn off but the Cruise (**TO CRUISE**) indicator will stay on.

NOTICE

If Cruise Control pauses during a situation that is not mentioned, we recommend that the vehicle be inspected by an authorized retailer of Genesis products.

Resuming Cruise Control

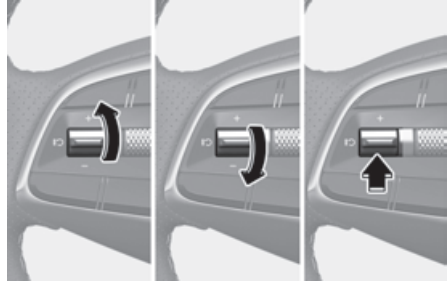

Operate the +, -, or **CC** switch.

If you push the + switch up or - switch down, vehicle speed will be set to the current speed on the cluster.

If you press the **CC** switch, vehicle speed will resume to the preset speed.

The vehicle speed must be above 30 km/h (20 mph) for Cruise Control to resume.

! WARNING

Check the driving condition before using the **CC** switch. Driving speed may sharply increase or decrease when you press the **CC** switch.

Turning off Cruise Control

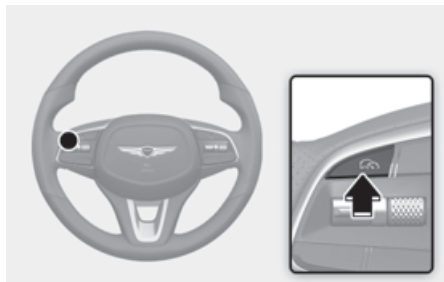

Press the Driving Assist button to turn Cruise Control off. The Cruise (CC) indicator will go off.

Always press the Driving Assist button to turn Cruise Control off when not in use.

i Information

If your vehicle is equipped with Manual Speed Limit Assist, press and hold the Driving Assist button to turn off Cruise Control. However, Manual Speed Limit Assist will turn on.

! WARNING

Take the following precautions when using Cruise Control:

- Always set the vehicle speed under the speed limit in your country.
- Keep Cruise Control off when the system is not in use, to avoid inadvertently setting a speed. Check that the Cruise (CC) indicator is off.
- Cruise Control does not substitute for proper and safe driving. It is the responsibility of the driver to always drive safely and should always be aware of unexpected and sudden situations from occurring.
- Always drive cautiously to prevent unexpected and sudden situations from occurring. Pay attention to the road conditions at all times.
- Do not use Cruise Control when it may be unsafe to keep the vehicle at a constant speed:
 - When driving in heavy traffic, or when traffic conditions make it difficult to drive at a constant speed
 - When driving on rainy, icy, or snow-covered roads
 - When driving on hilly or windy roads
 - When driving in windy areas
 - When driving with limited view (possibly due to bad weather, such as fog, snow, rain and sandstorm)
- Do not use Cruise Control when towing a trailer.

Smart Cruise Control (SCC)

 If equipped

Smart Cruise Control detects a vehicle ahead and helps maintain the distance from the vehicle ahead and the set speed.

Overtaking Acceleration Assist

When Smart Cruise Control judges you are attempting to overtake a vehicle in front, Smart Cruise Control helps with accelerating.

Detecting sensor



- (1) Front view camera
- (2) Front radar

The front view camera and front radar are used as a detecting sensor to detect front vehicles.

See the illustration above for the detailed location of the detecting sensors.

CAUTION

Always keep the front view camera and front radar in good condition to maintain optimal performance of Smart Cruise Control.

For more information on the precautions of the front view camera and front radar, refer to the “Forward Collision-Avoidance Assist (FCA) (Sensor fusion)” section in this chapter.

Smart Cruise Control settings

Smart Cruise Control

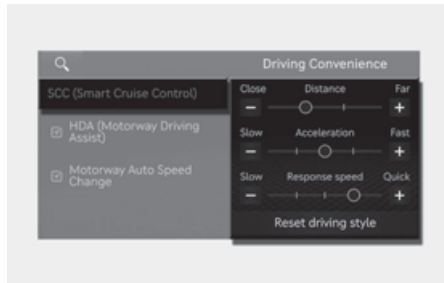

With the engine on, select **Setup (Settings) > Vehicle > Driver assistance > SCC (Smart Cruise Control)** from the settings menu in the infotainment system to change Distance, Acceleration, Reaction Speed manually.

Information

The infotainment system may change after software updates. For more information, refer to the manual provided in the infotainment system and the quick reference guide.

Warning methods



The Warning methods can be set with the engine on.

- **Warning volume:** Select **Setup (Settings) > Vehicle > Driver assistance > Warning methods > Warning volume** from the settings menu in the infotainment system to change the warning volume.

If you turn off the **Warning volume**, for your safety, the function may warn you with a low volume (if equipped).

- **Haptic warning:** Select **Setup (Settings) > Vehicle > Driver assistance > Warning methods > Haptic warning** from the settings menu in the infotainment system to set haptic warning (if equipped).
- **Driving safety priority:** Select **Setup (Settings) > Vehicle > Driver assistance > Warning methods > Driving safety priority** from the settings menu in the infotainment system.

If “**Driving safety priority**” is selected, the vehicle lowers all other audio volumes when the warning sounds for safe driving.

i Information

The infotainment system may change after software updates. For more information, refer to the manual provided in the infotainment system and the quick reference guide.

i Information

- If you change the Warning methods, the Warning methods of other Driver assistance systems may change.
- The **Warning volume** and **Haptic warning** cannot be turned off at the same time. When one of the warning is turned off the other is activated.
- If the engine is restarted, Warning methods will maintain the last setting.
- The setting menu may not exist depending on the vehicle specification.

Smart Cruise Control operation

Operating conditions

Basic function

Smart Cruise Control operates when the following conditions are satisfied.

- The gear is in D (Drive)
- Your vehicle speed is within the operating speed range
 - 10-200 km/h (5-120 mph): when there is no vehicle in front
 - 0-200 km/h (0-120 mph): when there is a vehicle in front
- ESC (Electronic Stability Control) or ABS (Anti-Lock Braking System) is on

Smart Cruise Control does not operate in the following conditions.

- The driver's door is opened
- Engine RPM is high
- Parking brake is applied
- ESC (Electronic Stability Control) or ABS (Anti-Lock Braking System) is controlling the vehicle
- Forward Collision-Avoidance Assist brake control is operating

i Information

When stopped behind another vehicle, the driver can turn on Smart Cruise Control while the brake pedal is depressed.

Operating conditions for Acceleration Assist

Overtaking Acceleration Assist operates when the turn signal indicator is turned on to the left (left-hand drive) or turned on to the right (right-hand drive) while Smart Cruise Control is operating, and the following conditions are satisfied:

- Your vehicle speed is above 60 km/h (40 mph)
- A vehicle is detected in front of your vehicle

Overtaking Acceleration Assist does not operate in the following conditions.

- The hazard warning flasher is on
- Vehicle speed is reduced to maintain distance with the vehicle in front

! WARNING

- When the turn signal indicator is turned on to the left (left-hand drive) or turned on to the right (right-hand drive) while there is a vehicle ahead, the vehicle may accelerate temporarily. Pay attention to the road conditions at all times.
 - Regardless of the driving direction in your country, Overtaking Acceleration Assist will operate when the conditions are satisfied. When using the function in countries with different driving direction, always check the road conditions at all times.
-

Turning on Smart Cruise Control

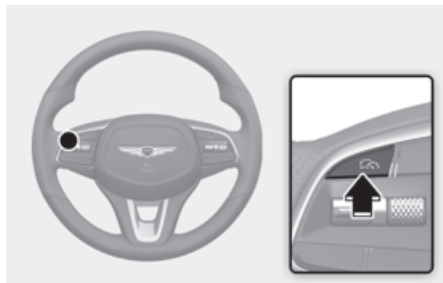

- Press the Driving Assist () button to turn on Smart Cruise Control. The speed will be set to the current speed on the cluster.
- If there is no vehicle in front of you, the set speed will be maintained, but if there is a vehicle in front of you, the speed may decrease to maintain the distance to the vehicle ahead. If the vehicle ahead accelerates, your vehicle will travel at a steady cruising speed after accelerating to the set speed.

i Information

If your vehicle speed is between 0-30 km/h (0-20 mph) when you press the Driving Assist () button, Smart Cruise Control speed will be set to 30 km/h (20 mph).

Setting vehicle distance



Press the button repeatedly to cycle through the headway settings from **Distance 4** → **Distance 3** → **Distance 2** → **Distance 1** → **Distance 4**.

If you drive at 90 km/h (56 mph), the distance is maintained as follows:

- Distance 4: about 52.5 m (172 ft)
- Distance 3: about 40 m (130 ft)
- Distance 2: about 32.5 m (106 ft)
- Distance 1: about 25 m (82 ft)

i Information

The distance is set to the last set distance when the vehicle is restarted, or when Smart Cruise Control was temporarily canceled.

Increasing set speed

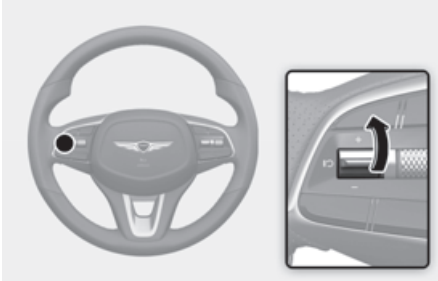

- Push the + switch up and release it immediately. The set speed will increase by 1 km/h (1 mph) each time the switch is operated in this manner.
- Push the + switch up and hold it while monitoring the set speed on the cluster. The set speed will increase by 10 km/h (5 mph) each time the switch is operated in this manner. Release the switch when the desired speed is shown, and the vehicle will accelerate to that speed. You can increase the set speed up to 200 km/h (120 mph).

WARNING

Check the driving condition before using the + switch. Driving speed may sharply increase when you push up and hold the + switch.

Decreasing set speed

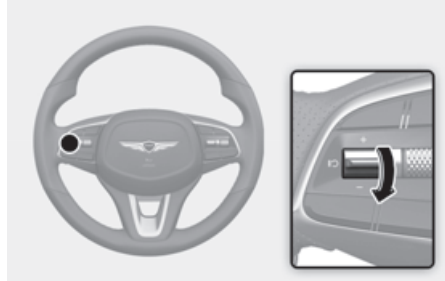

- Push the - switch down and release it immediately. The set speed will decrease by 1 km/h (1 mph) each time the switch is operated in this manner.
- Push the - switch down and hold it while monitoring the set speed on the cluster. The set speed will decrease by 10 km/h (5 mph) each time the switch is operated in this manner. Release the switch at the speed you want to maintain. You can decrease the set speed to 30 km/h (20 mph).

Temporarily cancelling Smart Cruise Control

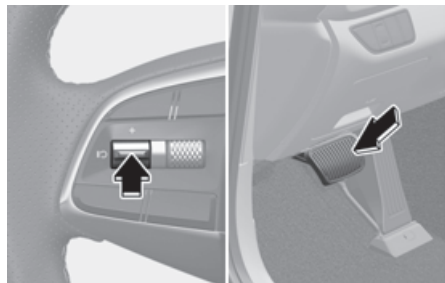

Press the  switch or depress the brake pedal to temporarily cancel Smart Cruise Control.

Resuming Smart Cruise Control

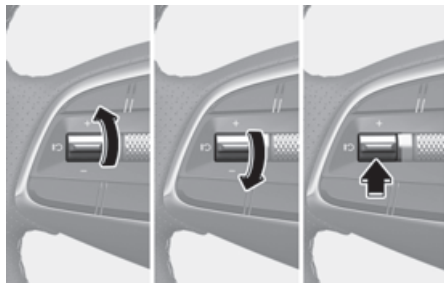

To resume Smart Cruise Control after the function was cancelled, operate the +, - or ||> switch.

If you push the + switch up or - switch down, vehicle speed will be set to the current speed on the cluster.

If you press the ||> switch, vehicle speed will resume to the preset speed.

WARNING

Check the driving condition before using the ||> switch. Driving speed may sharply increase or decrease when you press the ||> switch.

Turning off Smart Cruise Control

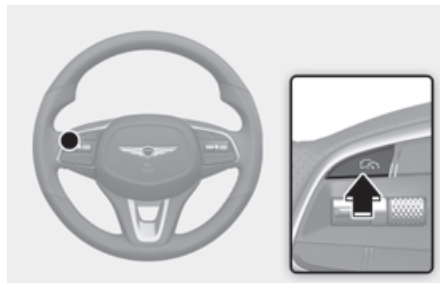

To turn Smart Cruise Control off, press the Driving Assist () button.

i Information

If your vehicle is equipped with Manual Speed Limit Assist, press and hold the Driving Assist () button to turn off Smart Cruise Control. However Manual Speed Limit Assist will turn on.

CAUTION

Do not use the switches and buttons at the same time. Smart Cruise Control may not operate properly.

Display and control

You can see the status of the Smart Cruise Control operation in the Driving Assist view on the cluster. Refer to the “Cluster display (Type A), Cluster display (Type B)” section in chapter 4.

Smart Cruise Control appears as below depending on the status of the function.

Operating

Sedan



Shooting Brake



- When operating
 - (1) Whether there is a vehicle ahead and the selected distance level
 - (2) Set speed
 - (3) Whether there is a vehicle ahead and the target vehicle distance

Temporarily cancelled

Sedan



Shooting Brake



- When temporarily cancelled
 - (1) Your vehicle (grey)
 - (2) Previous set speed (grey)

i Information

- The distance of the front vehicle on the cluster appears according to the actual distance between your vehicle and the vehicle ahead.
- The target distance may vary according to the vehicle speed and the set distance level. If the vehicle speed is low, even though the vehicle distance have changed, the change of the target vehicle distance may be small.
- The images and colors in the cluster may differ depending on the cluster type or theme selected from the cluster.

Accelerating temporarily

Sedan

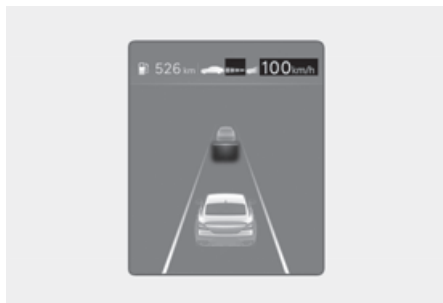

Shooting Brake



If you want to speed up temporarily without altering the set speed while Smart Cruise Control is operating, depress the accelerator pedal. While the accelerator pedal is depressed, the set speed, distance level and target distance will blink on the cluster.

However, if the accelerator pedal is depressed insufficiently, the vehicle may decelerate.

WARNING

Be careful when accelerating temporarily, because the speed and distance is not controlled automatically even if there is a vehicle in front of you.

Temporarily cancelling Smart Cruise Control

Type A

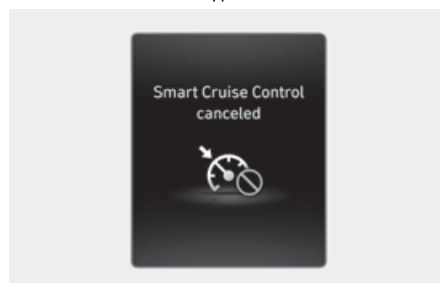

Type B

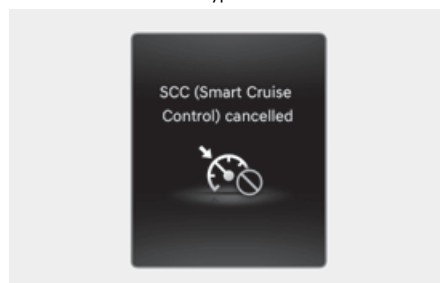

Smart Cruise Control will be temporarily cancelled automatically when:

- The vehicle speed is above 210 km/h (130 mph)
- The vehicle is stopped for a certain period of time
- The accelerator pedal is continuously depressed for a certain period of time
- The conditions for the Smart Cruise Control to operate is not satisfied

If Smart Cruise Control is temporarily cancelled automatically, the "**Smart Cruise Control canceled**" (or "**SCC (Smart Cruise Control) cancelled**") warning message will appear on the cluster, and an audible warning will sound to warn the driver.

If Smart Cruise Control is temporarily cancelled while the vehicle is at a standstill with the function activated, EPB (Electronic Parking Brake) maybe applied.

WARNING

When Smart Cruise Control is temporarily cancelled, distance with the front vehicle will not be maintained. Always have your eyes on the road while driving, and if necessary, depress the brake pedal to reduce your driving speed in order to maintain a safe distance.

Smart Cruise Control conditions not satisfied

Type A

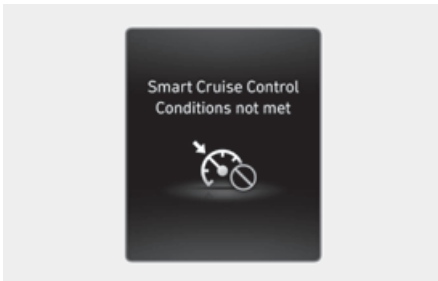

Type B

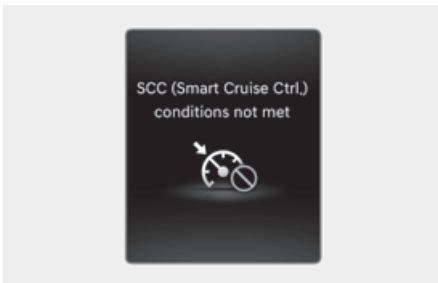

If the Driving Assist button, + switch, - switch or  switch is operated when Smart Cruise Control operating conditions are not satisfied, the "**Smart Cruise Control conditions not met**" (or "**SCC (Smart Cruise Ctrl. conditions not met)**") will appear on the cluster, and an audible warning will sound.

In traffic situation



In traffic, your vehicle will stop if the vehicle ahead of you stops. Also, if the vehicle ahead of you starts moving, your vehicle will start as well. In addition, after the vehicle has stopped and a certain time have passed, the "**Use switch or pedal to accelerate**" message will appear on the cluster. Depress the accelerator pedal or operate the + switch, - switch or  switch to start driving.

Warning road conditions ahead

Sedan

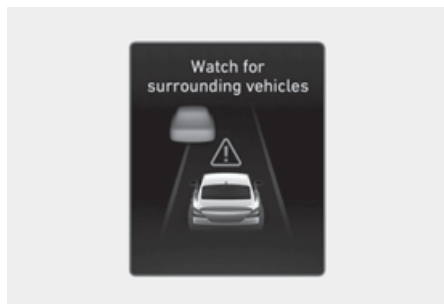

Shooting Brake

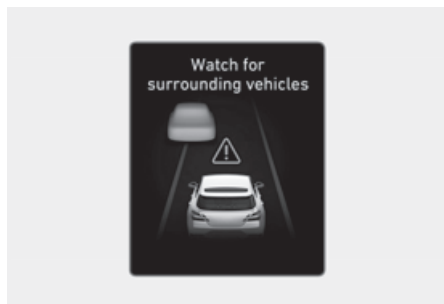
**Collision Warning**

Sedan

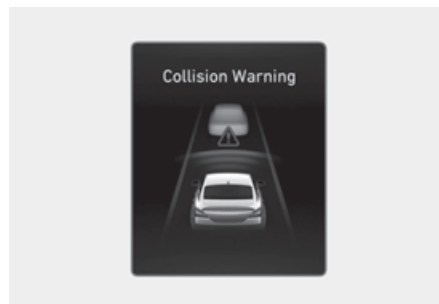

Shooting Brake

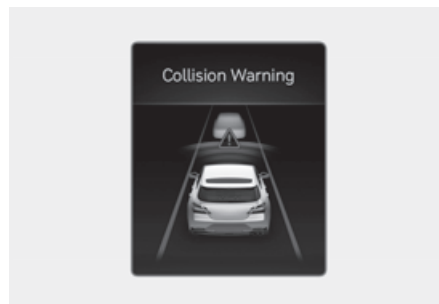

In the following situation, the **"Watch for surrounding vehicles"** warning message will appear on the cluster, and an audible warning will sound to warn the driver of road conditions ahead.

- The vehicle in front disappears when Smart Cruise Control is maintaining the distance with the vehicle ahead while driving below a certain speed.

WARNING

Always pay attention to vehicles or objects that may suddenly appear in front of you, and if necessary, depress the brake pedal to reduce your driving speed in order to maintain a safe distance.

While Smart Cruise Control is operating, when the collision risk with the vehicle ahead is high, the **"Collision Warning"** warning message will appear on the cluster, and an audible warning will sound to warn the driver. Always have your eyes on the road while driving, and if necessary, depress the brake pedal to reduce your driving speed in order to maintain a safe distance.

 **WARNING**

In the following situations, Smart Cruise Control may not warn the driver of a collision.

- The distance from the front vehicle is near, or the vehicle speed of the front vehicle is faster or similar to your vehicle
 - The speed of the front vehicle is very slow or is at a standstill
 - The accelerator pedal is depressed right after Smart Cruise Control is turned on
-

 **WARNING**

Take the following precautions when using Smart Cruise Control:

- Smart Cruise Control does not substitute for proper and safe driving. It is the responsibility of the driver to always check the speed and distance to the vehicle ahead.
- Smart Cruise Control may not recognize unexpected and sudden situations or complex driving situations, so always pay attention to driving conditions and control your vehicle speed.
- Keep Smart Cruise Control off when the function is not in use to avoid inadvertently setting a speed.
- Do not open the door or leave the vehicle when Smart Cruise Control is operating, even if the vehicle is stopped.
- Always be aware of the selected speed and headway distance.
- Keep a safe distance according to road conditions and vehicle speed. If the headway distance is too close during high-speed driving, a serious collision may result.
- When maintaining distance with the vehicle ahead, if the front vehicle disappears, Smart Cruise Control may suddenly accelerate to the set speed. Always be aware of unexpected and sudden situations from occurring.
- Vehicle speed may decrease on an upward slope and increase on a downward slope.
- Always be aware of situations such as when a vehicle cuts in suddenly.
- When you are towing a trailer or another vehicle, turn off Smart Cruise Control for safety reasons.
- Turn off Smart Cruise Control when your vehicle is being towed.
- Smart Cruise Control may not operate properly if interfered by strong electromagnetic waves.
- Smart Cruise Control may not detect an obstacle in front and lead to a collision. Always look ahead cautiously to prevent unexpected and sudden situations from occurring.

- Vehicles moving in front of you with a frequent lane change may cause a delay in Smart Cruise Control reaction or may cause Smart Cruise Control to react to a vehicle actually in an adjacent lane. Always drive cautiously to prevent unexpected and sudden situations from occurring.
- Always be aware of the surroundings and drive safely, even though a warning message does not appear or an audible warning does not sound.
- If any other system's warning message appears or warning sound is generated, Smart Cruise Control warning message may not be displayed and warning sound may not be generated.
- You may not hear the warning sound of Forward Collision-Avoidance Assist if the surrounding is noisy.
- The vehicle manufacturer is not responsible for any traffic violation or accidents caused by the driver.
- Always set the vehicle speed under the speed limit in your area.

i Information

- Smart Cruise Control may not operate for 15 seconds after the vehicle is started or the front view camera or front radar is initialized.
- You may hear a sound when the brake is controlled by Smart Cruise Control.

Smart Cruise Control malfunction and limitations

Smart Cruise Control malfunction

Type A

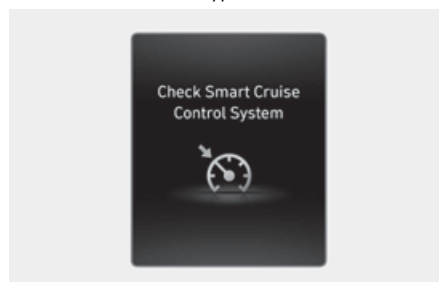

Type B

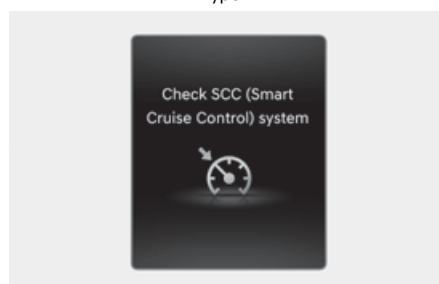

When Smart Cruise Control is not working properly, the "**Check Smart Cruise Control system**" (or "**Check SCC (Smart Cruise Control) system**") warning message will appear, and the master (⚠) warning light will illuminate on the cluster. If this occurs, we recommend that the vehicle be inspected by an authorized retailer of Genesis Branded products.

Smart Cruise Control disabled

Type A

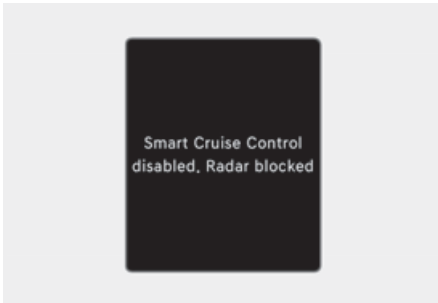

Type B

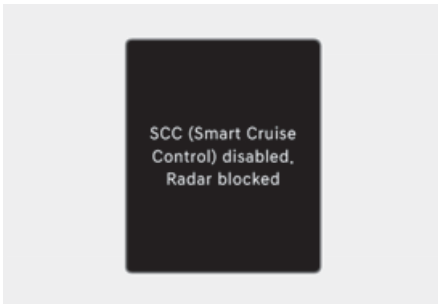

When the front radar cover or sensor is covered with snow, rain, or foreign material, it can reduce the detecting performance and temporarily limit or disable Smart Cruise Control.

If this occurs the "**Smart Cruise Control disabled. Radar blocked**" (or "**SCC (Smart Cruise Control) disabled. Radar blocked**") warning message will appear for a certain period of time on the cluster.

Smart Cruise Control will operate properly when snow, rain or foreign material is removed.

WARNING

Even though the warning message does not appear on the cluster, Smart Cruise Control may not properly operate.

CAUTION

Smart Cruise Control may not properly operate in an area (for example, open terrain), where any objects are not detected after turning ON the vehicle.

Limitations of Smart Cruise Control

Smart Cruise Control may not operate properly, or it may operate unexpectedly under the following circumstances:

- The detecting sensor or the surroundings are contaminated or damaged
- Washer fluid is continuously sprayed, or the wiper is on
- The camera lens is contaminated due to tinted, filmed or coated windshield, damaged glass, or sticky foreign material (sticker, bug, etc.) on the glass
- Moisture is not removed or frozen on the windshield
- The field of view of the front view camera is obstructed by sun glare
- Street light or light from an oncoming vehicle is reflected on the wet road surface, such as a puddle on the road
- The temperature around the front view camera is high or low
- An object is placed on the dashboard
- The surrounding is very bright
- The surrounding is very dark, such as in a tunnel, etc.
- The brightness changes suddenly, for example when entering or exiting a tunnel
- The brightness outside is low, and the headlights are not on or are not bright
- Driving in heavy rain or snow, or thick fog
- Driving through steam, smoke or shadow
- Only part of the vehicle is detected

- The vehicle in front has no tail lights, tail lights are located unusually, etc.
- The brightness outside is low, and the tail lights are not on or are not bright
- The rear of the front vehicle is small or does not look normal (for example, tilted, overturned, etc.)
- The front vehicle's ground clearance is low or high
- A vehicle suddenly cuts in front
- Your vehicle is being towed
- Driving through a tunnel or iron bridge
- Driving near areas containing metal substances, such as a construction zone, railroad, etc.
- An object reflecting off the front radar such as a guardrail, nearby vehicle, etc.
- The bumper around the front radar is impacted, damaged or the front radar is out of position
- The temperature around the front radar is high or low
- Driving in vast areas where there are few vehicles or structures (for example, desert, meadow, suburb, etc.)
- The vehicle in front is made of material that does not reflect on the front radar
- Driving near a highway (or motorway) interchange or tollgate
- Driving on a slippery surface due to snow, water puddle, ice, etc.
- Driving on a curved road
- The vehicle in front is detected late
- The vehicle in front is suddenly blocked by an obstacle
- The vehicle in front suddenly changes lane or suddenly reduces speed
- The vehicle in front is bent out of shape
- The front vehicle's speed is fast or slow
- With a vehicle in front, your vehicle changes lane at low speed
- The vehicle in front is covered with snow
- Unstable driving
- You are on a roundabout and the vehicle in front is not detected
- You are continuously driving in a circle
- Driving in a parking lot
- Driving through a construction area, unpaved road, partial paved road, uneven road, speed bumps, etc.
- Driving on an incline road, curved road, etc.
- Driving through a roadside with trees or streetlights
- The adverse road conditions cause excessive vehicle vibrations while driving
- Your vehicle height is low or high due to heavy loads, abnormal tire pressure, etc.
- Driving through a narrow road where trees or grass are overgrown
- There is interference by electromagnetic waves, such as driving in an area with strong radio waves or electrical noise

- **Driving on a curved road**



On curves, Smart Cruise Control may not detect a vehicle in the same lane, and may accelerate to the set speed. Also, vehicle speed may rapidly decrease when the vehicle ahead is detected suddenly.

Select the appropriate set speed on curves and apply the brake pedal or accelerator pedal according to the road and driving conditions ahead.



Your vehicle speed can be reduced due to a vehicle in the adjacent lane.

Apply the accelerator pedal and select the appropriate set speed. Check to be sure that the road conditions permit safe operation of the Smart Cruise Control.

- **Driving on an inclined road**



During uphill or downhill driving, the Smart Cruise Control may not detect a moving vehicle in your lane, and cause your vehicle to accelerate to the set speed. Also, vehicle speed will rapidly decrease when the vehicle ahead is detected suddenly.

Select the appropriate set speed on inclines and apply the brake pedal or accelerator pedal according to the road and driving conditions ahead.

• Changing lanes



[A] Your vehicle

[B] Lane changing vehicle

When a vehicle moves into your lane from an adjacent lane, it cannot be detected by the sensor until it is in the sensor's detection range. Smart Cruise Control may not immediately detect the vehicle when the vehicle changes lanes abruptly. In this case, you must maintain a safe braking distance, and if necessary, depress the brake pedal to reduce your driving speed in order to maintain a safe distance.

• Situations when detecting are limited

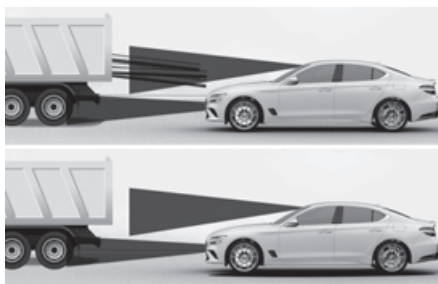
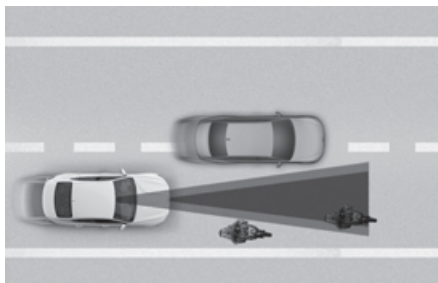

In the following cases, some vehicles, pedestrians or animals in your lane cannot be detected by the sensor:

- Vehicles offset to one side
- Slow-moving vehicles or sudden-decelerating vehicles
- Vehicles with higher ground clearance or vehicles carrying loads that stick out of the back of the vehicle
- Vehicles that has the front lifted due to heavy loads
- Vehicles within about 2 m (6 ft) from your vehicle
- Oncoming vehicles
- Stopped vehicles
- Vehicles with small rear profile, such as trailers
- Narrow vehicles, such as motorcycles or bicycles
- Special vehicles

- Animals and pedestrians

Adjust your vehicle speed by depressing the brake pedal according to the road and driving conditions ahead.

In the following cases, the vehicle in front cannot be detected by the sensor:

- You are steering your vehicle
- Driving on narrow or sharply curved roads
- When a vehicle ahead disappears at an intersection, your vehicle may accelerate.

Always pay attention to road and driving conditions while driving.

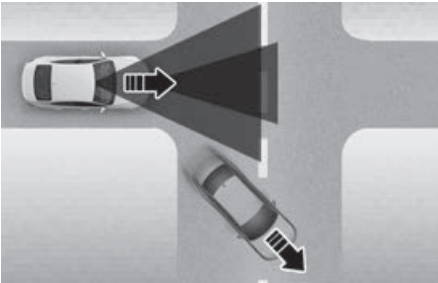

- When a vehicle in front of you merges out of the lane, Smart Cruise Control may not immediately detect the new vehicle that is now in front of you.

Always pay attention to road and driving conditions while driving.

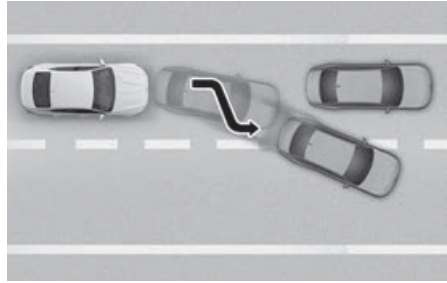

- Always look out for pedestrians when your vehicle is maintaining a distance with the vehicle ahead.

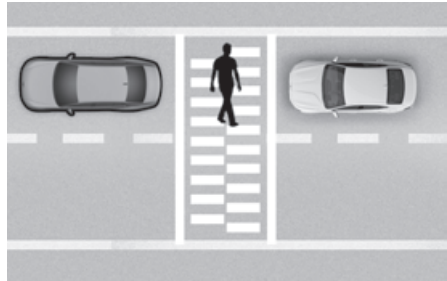

Navigation-based Smart Cruise Control (NSCC)

+ if equipped

Navigation-based Smart Cruise Control helps maintain safe speed depending on the road conditions by using information from the navigation system when driving on highways while Smart Cruise Control is operating.

i Information

- The Navigation-based Smart Cruise Control is available only on controlled access road of certain highways.
 - Controlled access road indicates roads with limited entrances and exits that allow uninterrupted high speed traffic flow. Only passenger cars and motorcycles are allowed on controlled access roads.
- Additional highways may be expanded by future navigation updates.

i Information

Navigation-based Smart Cruise Control operates on main roads of highways (or motorways), and does not operate on interchanges or junctions.

Highway Curve Zone Auto Slowdown

If vehicle speed is high, Highway Curve Zone Auto Slowdown function will temporarily decelerate your vehicle or limit acceleration to help you drive safely on a curve based on the curve information from the navigation.

Navigation-based Smart Cruise Control settings

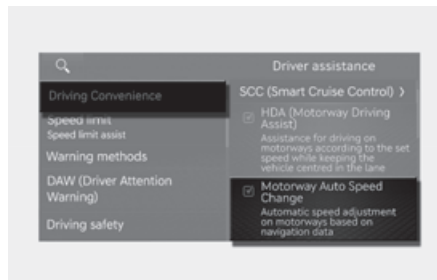

With the vehicle on, select **Setup (Settings) > Vehicle > Driver assistance > Driving Convenience > Motorway Auto Speed Change** from the Settings menu to turn on Navigation-based Smart Cruise Control and deselect to turn off the function.

i Information

- When there is a problem with Navigation-based Smart Cruise Control, the function cannot be set from the Settings menu.
- The infotainment system may change after software updates. For more information, refer to the manual provided in the infotainment system and the quick reference guide.

Navigation-based Smart Cruise Control operation

Operating conditions

Navigation-based Smart Cruise Control is ready to operate if all of the following conditions are satisfied:

- Smart Cruise Control is operating
- Driving on main roads of highways (or motorways)

i Information

For more information on how to operate Smart Cruise Control, refer to the “Smart Cruise Control (SCC)” section in this chapter.

Navigation-based Smart Cruise Control display and control

When Navigation-based Smart Cruise Control operates, it appears on the cluster as follows:

Navigation-based Smart Cruise Control standby

If the operating conditions are satisfied, the white **NAV** symbol will illuminate.



Navigation-based Smart Cruise Control operating

If the operating conditions are satisfied, the green **NAV** indicator light illuminates.

Temporarily canceled or interrupted by the driver

If Navigation-based Smart Cruise Control cannot control the vehicle, such as when Smart Cruise Control is temporarily canceled or the navigation system is searching for a route, the gray **NAV** indicator light illuminates.

When the driver depresses the accelerator pedal, the white **NAV** indicator light blinks.

⚠ WARNING

Sedan

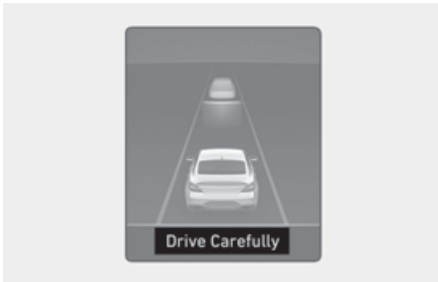

Shooting Brake

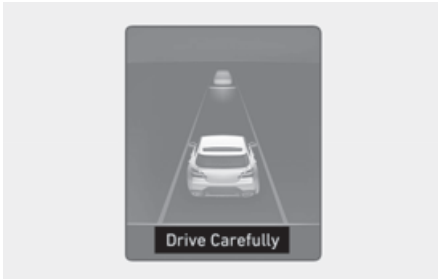

“**Drive carefully**” warning message will appear in the following circumstances:

- Navigation-based Smart Cruise Control is not able to slow down your vehicle to a safe speed

i Information

The images and colors in the instrument cluster may differ depending on the cluster type or theme selected from the settings menu.

i Information

Highway Curve Zone Auto Slowdown and Highway Set Speed Auto Change function uses the same **NAV** symbol.

Highway Curve Zone Auto Slowdown

Depending on the curve ahead on the highway (or motorway), the vehicle decelerates, and after passing the curve, the vehicle accelerates to Smart Cruise Control set speed.

- Vehicle deceleration time may differ depending on the vehicle speed and the degree of the curve on the road. The higher the driving speed, deceleration will start faster.

Limitations of Navigation-based Smart Cruise Control

Navigation-based Smart Cruise Control may not operate properly under the following circumstances:

- The navigation is not working properly
- Map information is not transmitted due to infotainment system's abnormal operation
- Speed limit and road information in the navigation is not updated
- The map information and the actual road is different because of real-time GPS data or map information error
- The navigation searches for a route while driving
- GPS signals are blocked in areas such as a tunnel
- A road that divides into two or more roads and joins again
- The driver goes off course the route set in the navigation
- The route to the destination is changed or cancelled by resetting the navigation
- The vehicle enters a service station or rest area
- Android Auto or Car Play is operating

- The navigation cannot detect the current vehicle position (for example, elevated roads including overpass adjacent to general roads or nearby roads exist in a parallel way)
- The navigation is being updated while driving
- The navigation is being restarted while driving
- The speed limit of some sections changes according to the road situations
- Driving on a road under construction
- Driving on a road that is controlled
- There is bad weather, such as heavy rain, heavy snow, etc.
- Driving on a road that is sharply curved

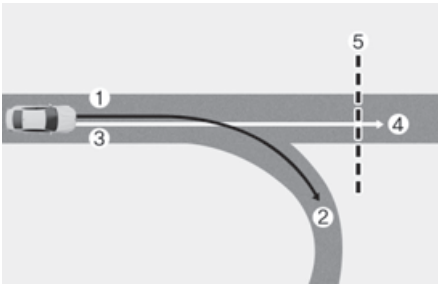

- (1) Set route
- (2) Branch line
- (3) Driving route
- (4) Main road
- (5) Curved road section

- When there is a difference between the navigation set route (branch line) and the driving route (main road), Highway Curve Zone Auto Slowdown function may not operate until the driving route is recognized as the main road.
- When the vehicle's driving route is recognized as the main road by maintaining the main road instead of the navigation set route, Highway Curve Zone Auto Slowdown function will operate. Depending on the distance to the curve and the current vehicle speed, vehicle deceleration may not be sufficient or may decelerate rapidly.

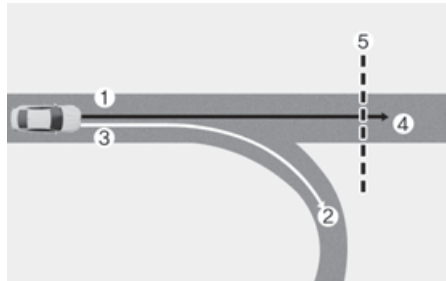

- (1) Set route
- (2) Branch line
- (3) Driving route
- (4) Main road
- (5) Curved road section

- When there is a difference between the navigation route (main road) and the driving route (branch line), Highway Curve Zone Auto Slowdown function will operate based on the curve information on the main road.
- When it is judged that you are driving out of the route by entering the highway interchange or junction, Highway Curve Zone Auto Slowdown function will not operate.
- If there is no destination set on the navigation, Highway Curve Zone Auto Slowdown function will operate based on the curve information on the main road.
- Even if you depart from the main road, Highway Curve Zone Auto Slowdown function may temporarily operate due to navigation information of the highway curve section.

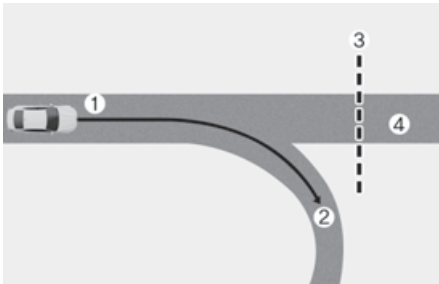

- (1) Driving route
- (2) Branch line
- (3) Curved road section
- (4) Main road

WARNING

- Navigation-based Smart Cruise Control is not a substitute for safe driving practices, but a convenience function. Always have your eyes on the road, and it is the responsibility of the driver to avoid violating traffic laws.
 - The navigation's speed limit information may differ from the actual speed limit information on the road. It is the driver's responsibility to check the speed limit on the actual driving road or lane.
 - Navigation-based Smart Cruise Control will automatically be cancelled when you leave the highway main road. Always pay attention to road and driving conditions while driving.
 - Navigation-based Smart Cruise Control may not operate due to the existence of leading vehicles and the driving conditions of the vehicle. Always pay attention to road and driving conditions while driving.
 - When you are towing a trailer or another vehicle, turn off Navigation-based Smart Cruise Control for safety reasons.
 - After you pass through a tollgate on a highway, Navigation-based Smart Cruise Control will operate based on the first lane. If you enter one of the other lanes, Navigation-based Smart Cruise Control might not operate properly.
 - The vehicle will accelerate if the driver depresses the accelerator pedal while Navigation-based Smart Cruise Control is operating, and the function will not decelerate the vehicle. However, if the accelerator pedal is depressed insufficiently, the vehicle may decelerate.
 - If the driver accelerates and releases the accelerator pedal while Navigation-based Smart Cruise Control is operating, the vehicle may not decelerate sufficiently or may rapidly decelerate to a safe speed.
 - If the curve is too large or too small, Navigation-based Smart Cruise Control may not operate.
-

Information

- A time gap could occur between the navigation's guidance and when Navigation-based Smart Cruise Control operation starts and ends.
 - The speed information on the cluster and navigation may differ.
 - Even if you are driving at a speed lower than Smart Cruise Control set speed, acceleration may be limited by the curve sections ahead.
 - If Navigation-based Smart Cruise Control is operating while leaving the main road to enter an interchange, junction, rest area, etc., the function may operate for a certain period of time.
 - Deceleration by Navigation-based Smart Cruise Control may feel it is not sufficient due to road conditions such as uneven road surfaces, narrow lanes, etc.
-

Lane Following Assist (LFA)

 if equipped

Lane Following Assist detects lane markings and/or a vehicle ahead on the road, and center your vehicle in the lane.

Detecting sensor



(1) Front view camera

The front view camera is used as a detecting sensor to detect lane markings and front vehicles.

Refer to the picture above for the detailed location of the detecting sensor.

CAUTION

For more information on the precautions of the front view camera, refer to the “Forward Collision-Avoidance Assist (FCA) (Sensor fusion)” section in this chapter.

Lane Following Assist settings

Warning Methods



The Warning Methods can be set with the engine on.

- **Warning volume:** Select **Setup (Settings) > Vehicle > Driver assistance > Warning Methods > Warning volume** in the infotainment system to change the warning volume.

If you turn off the **Warning Volume**, for your safety, the function may warn you with a low volume. (if equipped)

- **Driving safety priority:** Select **Setup (Settings) > Vehicle > Driver assistance > Warning Methods > Driving safety priority** in the infotainment system. If “**Driving safety priority**” is selected, the vehicle lowers all other audio volumes when the warning sounds for safe driving.

If **Driving Safety Priority** is selected, the vehicle lowers all other audio volumes when the warning sounds for safe driving.

i Information

- If you change the Warning Methods, the Warning Methods of other Driver Assistance systems may change.
 - If the engine is restarted, Warning Methods will maintain the last setting.
 - The setting menu may not exist based on vehicle specification.
 - The infotainment system may change after software updates. For more information, refer to the manual provided in the infotainment system and the quick reference guide.
-

Lane Following Assist operation

Turning Lane Following Assist On/Off

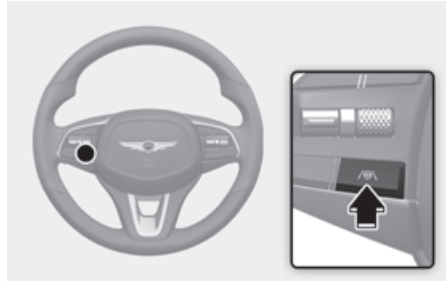

With the engine on, shortly press the Lane Driving Assist (/Ⓜ) button located on the steering wheel to turn on Lane Following Assist. The grey or green Ⓜ indicator light will appear on the instrument cluster.

Press the button again to turn off the function.

i Information

A long press of the Lane Driving Assist button turns Lane Keeping Assist on and off. For more information, refer to the “Lane Keeping Assist (LKA)” section in this chapter.

Warning and control

Lane Following Assist

Sedan



Shooting Brake



If the vehicle ahead and/or both lane markings are detected and your vehicle speed is below 200 km/h (120 mph), the green  indicator light illuminates on the cluster, and Lane Following Assist helps center the vehicle in the lane by assisting the steering wheel.

CAUTION

When the steering wheel is not assisted, the white  indicator light blinks and change to grey.

Hands-off warning

Type A

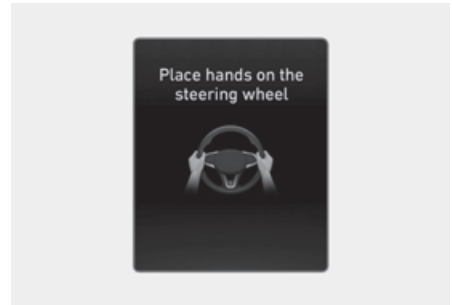

Type B



If the driver takes their hands off the steering wheel for several seconds, the "**Place hands on the steering wheel**" (or "**Keep hands on steering wheel**") warning message will appear and an audible warning will sound in stages.

First stage : Warning message

Second stage : Warning message (red steering wheel) and audible warning

Type A

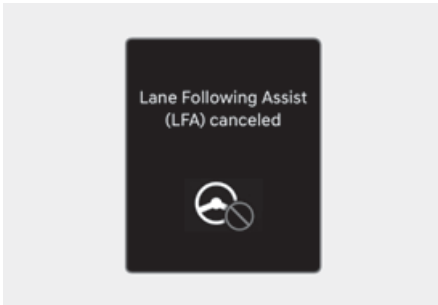

Type B

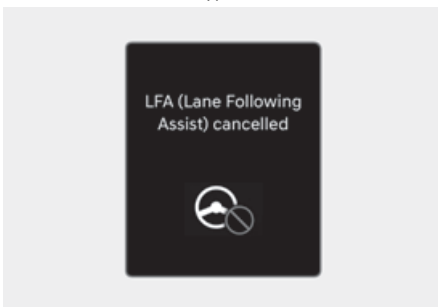

If the driver still does not have their hands on the steering wheel after the hands-off warning, the "**Lane Following Assist (LFA) canceled**" (or "**LFA (Lane Following Assist) canceled**") warning message will appear and Lane Following Assist will be automatically cancelled.

WARNING

- The steering wheel may not be assisted if the steering wheel is held very tight or the steering wheel is steered over a certain degree.
- Lane Following Assist does not operate at all times. It is the responsibility of the driver to safely steer the vehicle and to maintain the vehicle in its lane.
- The hands-off warning message may appear late depending on road conditions. Always have your hands on the steering wheel while driving.
- If the steering wheel is held very lightly the hands-off warning message may appear because Lane Following Assist may not recognize that the driver has their hands on the steering wheel.
- If you attach objects to the steering wheel, the hands-off warning may not work properly.

i Information

- For more information on setting the functions in the infotainment system Vehicle, refer to the “Cluster display (Type A), Cluster display (Type B)” section in chapter 4.
- When both lane markings are detected, the lane lines on the cluster will change from grey to white.

Sedan - Lane undetected



Sedan - Lane detected

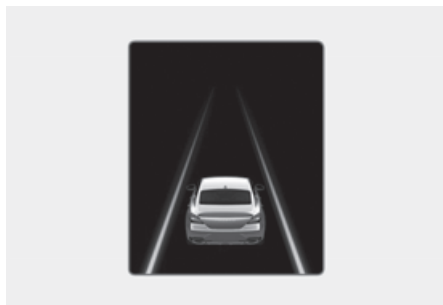

Shooting Brake - Lane undetected



Shooting Brake - Lane detected

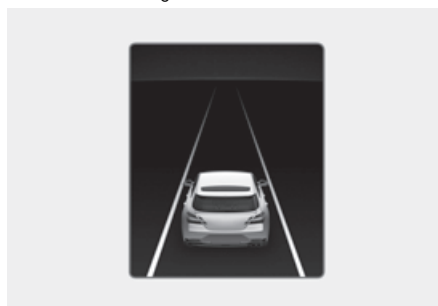

- The images and colors in the cluster may differ depending on the cluster type or theme selected from the cluster
- If lane markings are not detected, steering wheel control by Lane Following Assist can be limited depending on whether a vehicle is in front or the driving conditions of the vehicle.
- Even though the steering is assisted by Lane Following Assist, the driver may control the steering wheel.
- The steering wheel may feel heavier or lighter when the steering wheel is assisted by Lane Following Assist than when it is not.

Lane Following Assist malfunction and limitations

Lane Following Assist malfunction

Type A

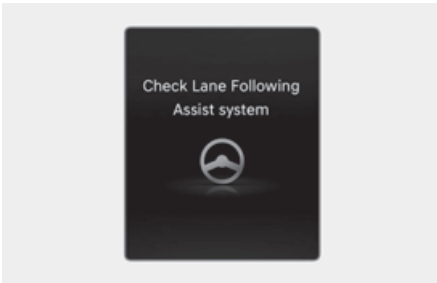

Type B

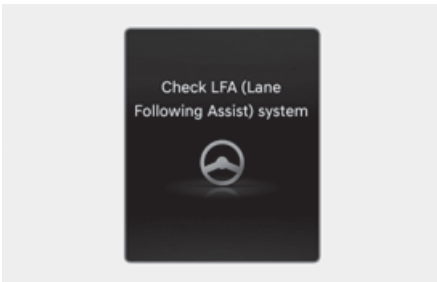

When Lane Following Assist is not working properly, the "**Check Lane Following Assist (LFA) system**" (or "**Check LFA (Lane Following Assist) system**") warning message will appear for several seconds, and the master (⚠) warning light will illuminate on the cluster. If this occurs, we recommend that the vehicle be inspected by an authorized retailer of Genesis Branded products.

Limitations of Lane Following Assist

For more information on Lane Following Assist limitations, refer to the "Lane Keeping Assist malfunction and limitations" section in this chapter.

i Information

For more information on Lane Following Assist precautions, refer to the "Lane Keeping Assist (LKA)" section in this chapter.

Highway Driving Assist (HDA)

+ if equipped

Highway Driving Assist detect lanes and vehicles ahead, and help maintain the distance from the vehicle ahead and the set speed, and center your vehicle in the lane while driving on the highway.

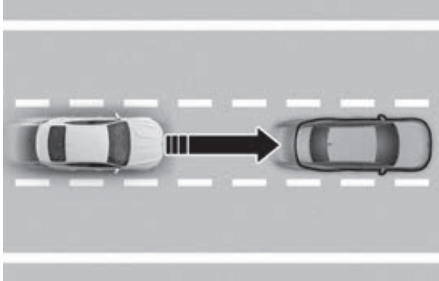

i Information

- Highway Driving Assist is available only on controlled access road of certain highways.
 - Controlled access road indicates roads with limited entrances and exits that allow uninterrupted high speed traffic flow. Only passenger cars and motorcycles are allowed on controlled access roads.
- Additional highways may be expanded by future navigation updates.

i Information

Navigation-based Smart Cruise Control operates on main roads of highways (or motorways), and does not operate on interchanges or junctions.

Detecting sensor



- (1) Front view camera
- (2) Front radar

Refer to the illustration above for the detailed location of the detecting sensors.

! CAUTION

For more information on the precautions of the detecting sensors, refer to the “Forward Collision-Avoidance Assist (FCA) (Sensor fusion)” section in this chapter.

Highway Driving Assist settings

Setting features

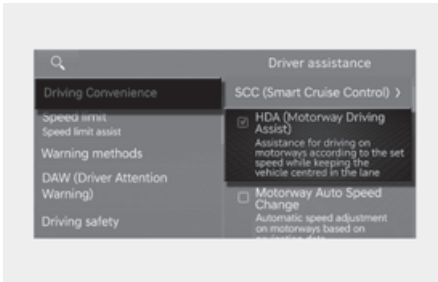

Basic function

With the vehicle on.

HDA (Motorway driving Assist): Select **Setup (Settings) > Vehicle > Driver assistance > Driving Convenience > HDA (Motorway driving Assist)**. From the Settings menu to set whether to use each function.

- If **HDA (Motorway driving Assist)** is selected, it helps maintain distance from the vehicle ahead, maintain the set speed, and helps center the vehicle in the lane.

i Information

- If there is a problem with the function(s), the settings cannot be changed. We recommend that the vehicle be inspected by an authorized retailer of Genesis Branded products.
- If the engine is restarted, the function(s) will maintain the last setting.
- The infotainment system may change after software updates. For more information, refer to the manual provided in the infotainment system and the quick reference guide.

WARNING

For your safety, change the Settings after parking the vehicle at a safe location.

Warning methods



The Warning Methods can be set with the engine on.

- **Warning volume:** Select **Setup (Settings) > Vehicle > Driver assistance > Warning methods > Warning volume** from the settings menu in the infotainment system to change the warning volume.

If you turn off the **Warning volume**, for your safety, the function may warn you with a low volume. (if equipped)

- **Driving safety priority:** Select **Setup (Settings) > Vehicle > Driver assistance > Warning methods > Driving safety priority** from the settings menu in the infotainment system.

If **Driving Safety Priority** is selected, the vehicle lowers all other audio volumes when the warning sounds for safe driving.

i Information

- If you change the Warning Methods, the Warning Methods of other Driver Assistance systems may change.
- If the engine is restarted, Warning Methods will maintain the last setting.
- The setting menu may not exist based on vehicle specification.
- The infotainment system may change after software updates. For more information, refer to the manual provided in the infotainment system and the quick reference guide.

Highway Driving Assist operation

Basic function

Displaying operating status

You can see the status of the Highway Driving Assist operation in the Driving Assist view on the instrument cluster. Refer to the “Cluster display (Type A), Cluster display (Type B)” section in chapter 4.

Highway Driving Assist appears as below depending on the status of the function.

Sedan - Operating state



Shooting Brake - Operating state



Sedan - Standby state



Shooting Brake - Standby state



1. Highway Driving Assist indicator, whether there is a vehicle ahead and the selected distance level appear.

- Highway Driving Assist indicator (HDA)
 - Green HDA: Operating state
 - Grey HDA: Standby state
 - White HDA blink: Accelerator depressed state

2. Set speed

3. Lane Following Assist indicator

4. Whether there is a vehicle ahead and the selected headway

5. Whether the lane is detected or not

i Information

- For more information on the display, refer to the “Lane Following Assist (LFA)” and “Smart Cruise Control (SCC)” sections in this chapter.
- The images and colors in the instrument cluster may differ depending on the instrument cluster type or theme selected from the settings menu.

Highway Driving Assist operation

Highway Driving Assist operates when:

- Driving on the main road of highways, and turning on Highway Driving Assist by pressing the Driving Assist button
- Entering the main road of highways while Lane Following assist and Smart Cruise Control are operating

Restarting after stopping

When Highway Driving Assist is operating, your vehicle will stop if the vehicle ahead of you stops. Also, if the vehicle ahead of you starts moving within 30 seconds after the stop, your vehicle will start as well. In addition, after the vehicle has stopped and 30 seconds have passed, the **"Use switch or pedal to accelerate"** message will appear on the instrument cluster. Depress the accelerator pedal or operate the + switch, - switch or  switch to start driving.



Hands-off warning

Type A

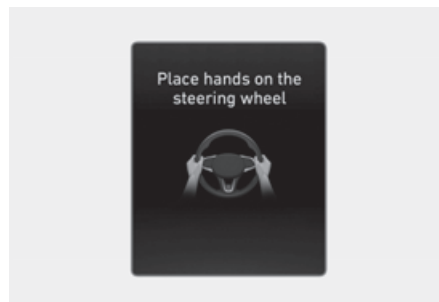

Type B

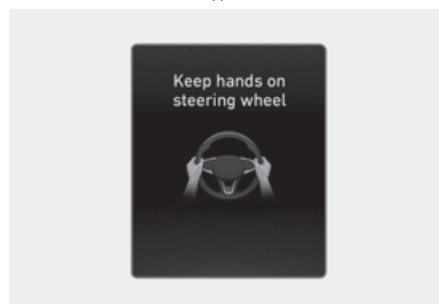

If the driver takes their hands off the steering wheel for several seconds, the **"Keep hands on steering wheel or Place hands on the steering wheel"** warning message will appear and an audible warning will sound in stages.

First stage: Warning message

Second stage: Warning message (red steering wheel) and audible warning

Type A

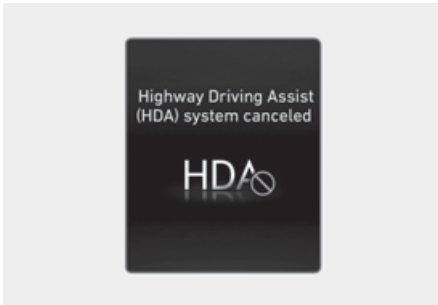

Type B



If the driver still does not have their hands on the steering wheel after the hands-off warning, "**Highway Driving Assist (HDA) system canceled**" or **HDA (Motorway Driving Assist) sys. cancelled** warning message will appear and Highway Driving Assist and Lane Change Assist will be automatically canceled.

Driving speed limit

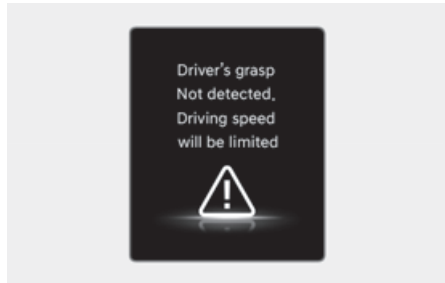

When Highway Driving Assist is canceled by the hands-off warning, The driving speed will be limited.

While Driving Speed Limit function is operating, the "**Driver's grasp not detected. Driving speed will be limited**" warning message will appear on the instrument cluster, and an audible warning will sound continuously.

Highway Driving Assist standby

When the Smart Cruise Control is temporarily canceled while Highway Driving Assist is operating, Highway Driving Assist will be in the standby state. At this time, Lane Following Assist will operate properly.

i Information

- Driving Speed Limit helps you drive below 60 km/h (40 mph). At this time, the vehicle decelerates due to the vehicle ahead. After the vehicle has decelerated, it cannot automatically accelerate.
- Driving Speed Limit will cancel in the following circumstances:
 - When the driver grabs the steering wheel again
 - When the driver turns on Lane Following Assist by pressing the Lane Driving Assist button (LDA)
 - When +, -, ||⏏ switch or ⏏ button is operated, or the accelerator pedal or the brake pedal is depressed

Highway Driving Assist malfunction and limitations

Highway Driving Assist malfunction

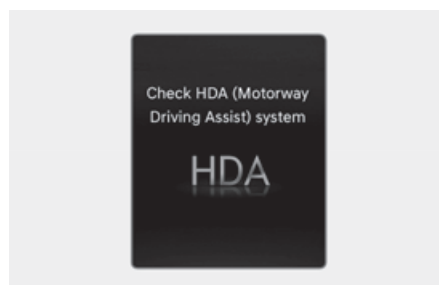
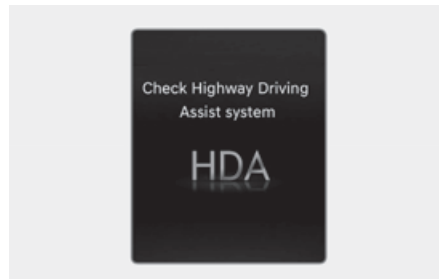

When Highway Driving Assist or Highway Lane Change function is not working properly, the "**Check Highway Driving Assist (HDA) system**" or "**Check HDA (Motorway Driving Assist)**" warning message will appear, and the  warning light will illuminate on the cluster. We recommend that the vehicle be inspected by an authorized retailer of Genesis Branded products

 **WARNING**

- The driver is responsible for controlling the vehicle for safe driving.
- Always have your hands on the steering wheel while driving.
- Highway Driving Assist is a supplemental function that assists the driver in driving the vehicle and is not a complete autonomous driving system. Always check road conditions, and if necessary, take appropriate actions to drive safely.
- Always have your eyes on the road, and it is the responsibility of the driver to avoid violating traffic laws. The vehicle manufacturer is not responsible for any traffic violation or accidents caused by the driver.
- Highway Driving Assist may not be able to recognize all traffic situations. Highway Driving Assist may not detect possible collisions due to limitations of the function. Always be aware of the limitations of the function. Obstacles such as vehicles, motorcycles, bicycles, pedestrians, or unspecified objects or structures such as guardrails, tollgate, etc., that may collide with the vehicle may not be detected.
- Highway Driving Assist will turn off automatically under the following situations:
 - Driving on roads that Highway Driving Assist does not operate, such as a rest area, intersection, junction, etc.
 - The navigation does not operate properly such as when the navigation is being updated or restarted
- Highway Driving Assist may inadvertently operate or turn off depending on road conditions (navigation information) and surroundings.
- Lane Following Assist function may be temporarily disabled when the front view camera cannot detect lanes properly or the hands-off warning is on.
- You may not hear the warning sound of Highway Driving Assist if the surrounding is noisy.
- If the vehicle is driven at high speed above a certain speed at a curve, your vehicle may drive to one side or may depart from the driving lane.
- When you are towing a trailer or another vehicle, turn off Highway Driving Assist for safety reasons.
- The hands-off warning message may appear early or late depending on how the steering wheel is held or road conditions. Always have your hands on the steering wheel while driving.
- For your safety, please read the owner's manual before using Highway Driving Assist.
- Highway Driving Assist will not operate when the vehicle is started, or when the detecting sensors or navigation is being initialized.

Limitations of Highway Driving Assist

Highway Driving Assist and Highway Lane Change Assist function may not operate properly, or it may not operate under the following circumstances:

- The map information and the actual road is different because the navigation is not updated
- The map information and the actual road is different because of real-time GPS data or map information error
- The infotainment system is overloaded by simultaneously performing functions such as route search, video playback, voice recognition, etc.
- GPS signals are blocked in areas such as a tunnel

- The driver goes off course or the route to the destination is changed or cancelled by resetting the navigation
- The vehicle enters a service station or rest area
- Android Auto or Car Play is operating
- The navigation cannot detect the current vehicle position (for example, elevated roads including overpass adjacent to general roads or nearby roads exist in a parallel way)
- White single dotted lane line or road edge cannot be detected
- The road is temporarily controlled due to construction, etc.
- There is no structure, such as a medium strip, guardrails, etc., on the road
- There is a changeable lane in the direction of lane change
- Rear wheel steering system (if equipped) is disabled

i Information

For more information on the limitations of the front view camera, front radar, front corner radar and rear corner radar, refer to the “Forward Collision-Avoidance Assist (FCA) (Sensor fusion)” section in this chapter.

Rear View Monitor (RVM)

+ if equipped

Rear View Monitor displays the area behind your vehicle to help with safe parking or driving.

Detecting sensor

Sedan



Shooting Brake



(1) Wide-rear view camera

Refer to the illustration above for the detailed location of the detecting sensor.

Rear View Monitor settings

Warning methods

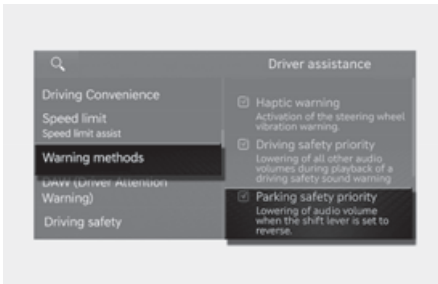

The Warning methods can be set with the engine on.

- **Parking safety priority:** Select **Setup (Settings) > Vehicle > Driver assistance > Warning methods > Parking safety priority** in the infotainment system.

If **Parking safety priority** is enabled, the vehicle lowers all other audio volumes when Rear View Monitor is operating.

i Information

- If you change the Warning methods, the Warning methods of other Driver Assistance systems may change.
- If the vehicle is restarted, Warning methods will maintain the last setting.
- The setting menu may not exist based on vehicle specification.
- The infotainment system may change after software updates. For more information, refer to the manual provided in the infotainment system and the quick reference guide.

Camera settings

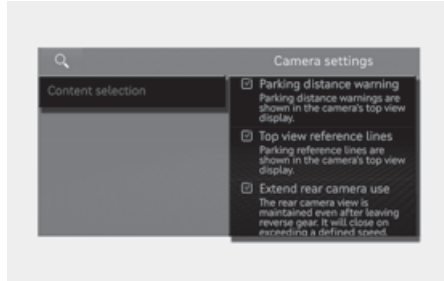

You can change Rear View Monitor **Content selection** by touching the setup icon (ⓘ) on the screen while Rear View Monitor is operating, select **Setup (Settings) > Vehicle > Driver assistance > Parking safety > Camera settings** from the Settings menu in the infotainment system while the engine is on.

In the **Content selection**, you can change settings for **Extended rear camera use**, **Top view reference lines** and **Rear view reference lines (Rear View Parking Lines)**.

Extended rear camera use

Keeps displaying the rear view when shifting from R (Reverse) to N (Neutral) or D (Drive). When exceeding a certain speed, the rear view stops displaying.

Rear View Parking Lines



If **Rear view reference lines (Rear View Parking Lines)** is selected, the rear view parking guide lines and rear top view guide lines appear on the Rear View Monitor screen.

i Information

The infotainment system may change after software updates. For more information, refer to the manual provided in the infotainment system and the quick reference guide.

i Information

- The horizontal guideline of the Rear View Parking Guidance shows the distance of 0.5 m (1.6 ft), 1 m (3.3 ft) and 2.3 m (7.6 ft) from the vehicle.
- The horizontal guideline of the Rear Top View Parking Guidance shows the distance of 0.5 m (1.6 ft.) and 1.5 m (4.9 ft.) from the vehicle for sedan, or shows the tailgate opening distance and 1.5 m (4.9 ft.) from the vehicle for shooting brake.

Rear View Monitor operation

Parking/View button



Press the Parking/View button (1) to turn on Rear View Monitor.

Press the button again to turn off the function.

Rear view



Rear top view



Operating conditions

- Shift the gear to R (Reverse), the rear view will turn on.
- Press the Parking/View button (1) while the gear is in P (Park), the rear view will turn on.
- select view button (2), the rear view will turn on.

Off conditions

- Press the Parking/View button (1) again while the gear is in P (Park) with the rear view on the screen, the rear view will turn off.
- Shift the gear from R (Reverse) to P (Park), the rear view will turn off.

i Information

When the gear is in R (Reverse), the rear view does not turn off.

When you touch the  icon, the top view appears on the screen and shows the distance from the vehicle in the back of your vehicle while parking.

Extended Rear View Monitor

The rear view will maintain showing on the screen to help you when parking.

Operating conditions

The gear is shifted from R (Reverse) to N (Neutral) or D (Drive), and vehicle speed is 10 km/h (6 mph) or less.

Off conditions

- When vehicle speed is above 10 km/h (6 mph), the rear view will turn off.
- Press the Parking/View button (1), the rear view will turn off.
- Shift the gear to P (Park), the rear view will turn off.
- Press the Infotainment system button (2), the rear view will turn off.
- press the home button, the rear view will turn off.

Rear View while driving



The driver is able to check the rear view on the screen while driving, it is to assist with backing up.

Operating conditions

Press the Parking/View button (1) while the gear is in D (Drive) or N (Neutral), the driving rear view will appear on the screen.

Off conditions

- Press the Parking/View button (1) again, the driving rear view will turn off.
- Press one of the infotainment system button (2), the driving rear view will turn off.
- Shift the gear to P (Park), the driving rear view will turn off.

When operating

If the gear is shifted to R (Reverse), when rear view while driving appears on the screen, the screen will change to rear view.

i Information

- The rear view does not turn off regardless of the mode when the gear is in R (Reverse).
- When the rear view is activated, the latest used view mode appears.
- The rear parking guidelines appear in rear view and rear top view mode. (When pressing the **SETUP** button, and then selecting **Vehicle > Driver assistance > Parking Safety > Camera Settings > Content selection > Rear view reference lines (Rear View Parking Lines)** in the infotainment system) However, rear parking guidelines are not displayed in the rear view while driving.
- The infotainment system may change after software updates. For more information, refer to the manual provided in the infotainment system and the quick reference guide.
- The rear view while driving does not turn off even when the vehicle speed is lower than 10 km/h (6 mph) once it is on.
- When the rear view while driving is on, the rear top view will be deactivated.

Rear View Monitor malfunction and limitations

Rear View Monitor malfunction

When Rear View Monitor is not working properly, or the screen flickers, or the camera image does not display properly, we recommend that the vehicle be inspected by an authorized retailer of Genesis Branded products.

Limitations of Rear View Monitor

When the vehicle is stopped for a long time in winter or when the vehicle is parked in an indoor parking lot, the exhaust fumes may temporarily blur the image.

WARNING

- The wide-rear view camera does not cover the complete area behind the vehicle. The driver should always check the rear area directly through the inside and outside rearview mirror before parking or backing up.
 - The image shown on the screen may differ from the actual distance of the object. Make sure to directly check the vehicle's surroundings for safety.
 - Always keep the wide-rear view camera lens clean. If the lens is covered with foreign material, it may adversely affect camera performance and Rear View Monitor may not operate properly. However, do not use chemical solvents such as strong detergents containing high alkaline or volatile organic solvents (gasoline, acetone etc.). This may damage the camera lens.
-

Surround View Monitor (SVM)

 If equipped

Surround View Monitor uses the wide view cameras and displays images around your vehicle through the infotainment system to help with safe parking or driving.

Detecting sensor



Sedan



Shooting Brake



- (1) Wide-front view camera
- (2) Wide-side view camera (under the outside rearview mirror)
- (3) Wide-side view camera (under the outside rearview mirror)
- (4) : Wide-rear view camera

Refer to the illustration above for the detailed location of the detecting sensors.

Surround View Monitor settings

Warning methods

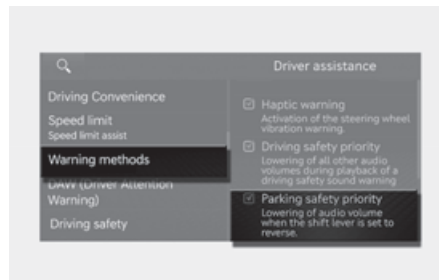

The Warning methods can be set with the engine on.

- **Parking safety priority:** Select **Setup (Settings) > Vehicle > Driver assistance > Warning methods > Parking safety priority** in the infotainment system.

If **Parking safety priority** is enabled, the vehicle lowers all other audio volumes when Surround View Monitor is operating.

i Information

- If you change the Warning methods, the Warning methods of other Driver Assistance systems may change.
- If the engine is restarted, Warning methods will maintain the last setting.
- The setting menu may not exist based on vehicle specification.
- The infotainment system may change after software updates. For more information, refer to the manual provided in the infotainment system and the quick reference guide.

Camera settings

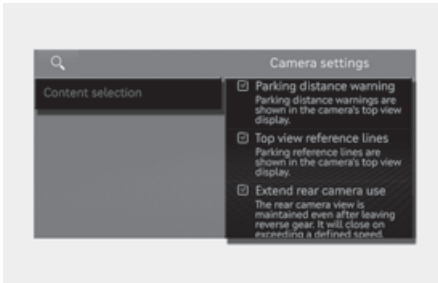

You can change Surround View Monitor **Content selection** by touching the setup icon (⚙️) on the screen while Surround View Monitor is operating, or selecting **Setup (Settings) > Vehicle > Driver assistance > Parking safety > Camera settings** from the Settings menu in the infotainment system while the engine is on.

- In the **Content selection**, you can change settings for **Parking distance warning, Top view parking lines, Extend rear camera use** and **Rear view reference lines (Rear View Parking Lines)**.

i Information

- The setting menu may not exist based on vehicle specification.
- The infotainment system may change after software updates. For more information, refer to the manual provided in the infotainment system and the quick reference guide.

Parking distance warning

When the **Parking distance warning** is selected, parking distance warning appears on the right side of the Surround View Monitor screen.

Top view reference lines

When the **Top view reference lines** is selected, parking guidance appears on the right side of the Surround View Monitor screen.

i Information

The horizontal guideline of the Rear Top View Parking Guidance shows the distance of 0.5 m (1.6 ft.) and 2 m (6.6 ft.) from the vehicle for sedan or shows the tailgate opening distance and 2 m (6.6 ft.) from the vehicle for shooting brake.

Rear view reference lines

When the **Rear view reference lines** is selected, parking guidance appears in the rear view.

i Information

The horizontal guideline shows the distance of 0.5 m (1.6 ft.), 1 m (3.3 ft.) and 2.3 m (7.6 ft.).

Surround View Monitor Auto On

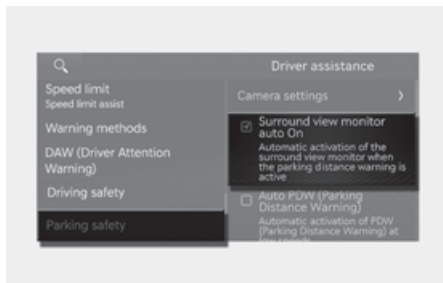

With the engine on, select **Setup (Settings) > Vehicle > Driver assistance > Parking safety > Surround view monitor auto On** from the Settings menu in the infotainment system to use the function.

i Information

- For more information on Surround View Monitor auto On, refer to the “Surround View Monitor operation” in this chapter.
- The infotainment system may change after software updates. For more information, refer to the manual provided in the infotainment system and the quick reference guide.

Surround View Monitor operation

Parking/View button



Press the Parking/View button (1) to turn on Surround View Monitor.

Press the Parking/View button (1) again to turn off the function.

Front view



The front view appears on the screen when the gear is in N (Neutral) or D (Drive) to assist in parking.

You may select top view, front view, side view and wide view using the change view button (2).

Operating conditions

- The gear is shifted to N (Neutral) or D (Drive) from R (Reverse) and the vehicle speed is 10 km/h (6 mph) or less.
- The Parking/View button (1) is pressed, while the gear is in P (Park), N (Neutral) or D (Drive), and vehicle speed is 10 km/h (6 mph) or less.
- The Parking Distance Warning occurs while the gear is in D (Drive).
- **Surround view monitor auto On** function is operated.

When **Driver assistance > Parking safety > Surround view monitor auto On** is selected from the Settings menu, the front view while parking appears.

i Information

- When the front view is activated, the latest used view mode appears.
- The infotainment system may change after software updates. For more information, refer to the manual provided in the infotainment system and the quick reference guide.

Off conditions

- The gear is shifted from N (Neutral) or D (Drive) to P (Park) or R (Reverse).
- The Parking/View button (1) or the Infotainment system button (3) is Pressed.
- Vehicle speed is above 10 km/h (6 mph).

i Information

Surround View Monitor may turn off when vehicle speed is above 10 km/h (6 mph). However, Surround View Monitor may not turn on again although vehicle speed drops below 10 km/h (6 mph).

Rear view

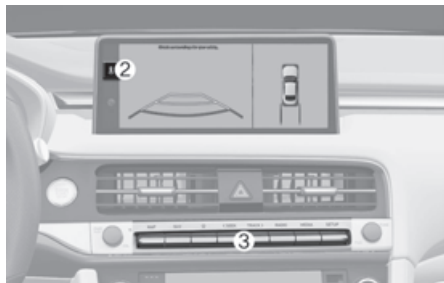

The rear view appears on the screen to assist in parking.

You may select rear top view, rear view, rear side view and rear wide view using the change view button (2).

Operating conditions

- The gear is shifted to R (Reverse).
- The rear view is selected by pressing the change view button (2) after pressing the Parking/View button (1), while the gear is in P (Park), N (Neutral) or D (Drive), and vehicle speed is 10 km/h (6 mph) or less.

Off conditions

- The gear is shifted to R (Reverse).
- The Parking/View button (1) is pressed, while the gear is in P (Park).

i Information

When the gear is in R (Reverse), the rear view does not turn off even if the infotainment system button (3) is Pressed.

Rear View while driving

The driver is able to check the rear view on the screen while driving, it is to assist with backing up.

Operating conditions

- The rear view is selected by pressing the change view button (2) after pressing the Parking/View button (1), while the gear is in N (Neutral) or D (Drive), and vehicle speed is above 10 km/h (6 mph).

You may select rear view or rear wide view using the change view button (2).

Off conditions

- The gear is shifted to P (Park).
- The Parking/View button (1) or the Infotainment system button (3) is Pressed.

i Information

- When the rear view while driving is activated, the latest used view mode appears.
- The Rear View Parking Lines does not operate on the rear view while driving.
- The rear view while driving does not turn off even when the vehicle speed is lower than 10 km/h (6 mph) once it is on.
- When the rear view while driving is on, the rear top view and rear side view are deactivated in all speed.

Surround View Monitor malfunction and limitations

Surround View Monitor malfunction

When Surround View Monitor is not working properly, or the screen flickers, or the camera image does not display properly, we recommend that the vehicle be inspected by an authorized retailer of Genesis Branded products.

Limitations of Surround View Monitor

- When the vehicle is stopped for a long time in winter or when the vehicle is parked in an indoor parking lot, the exhaust fumes may temporarily blur the image.
- The screen may appear abnormally, and an icon will appear at the top left side of the screen under the following circumstances:
 - The trunk (or tailgate) is opened
 - The driver or front passenger door is opened
 - The outside rearview mirror is folded

WARNING

- Always look around your vehicle to make sure there are no objects or obstacles before moving the vehicle. What you see on the screen may differ from the actual vehicle's location.
- The image shown on the screen may differ from the actual distance of the object. Make sure to directly check the vehicle's surroundings for safety.
- Surround View Monitor is designed to be used on a flat surface. Therefore, if used on roads with different heights such as curbs and speed bumps, the image in the screen may not look correct.
- Always keep the camera lens clean. If the lens is covered with foreign material, it may adversely affect camera performance and Surround View Monitor may not operate properly. However, do not use chemical solvents such as strong detergents containing high alkaline or volatile organic solvents (gasoline, acetone etc.). This may damage the camera lens.

Information

Surround View Monitor uses the cameras installed on the vehicle to show images around the vehicle through the infotainment system. The image shown on the screen may look unnatural depending on the surroundings.

Rear Cross-Traffic Collision-Avoidance Assist (RCCA)

 if equipped

Rear Cross-Traffic Collision-Avoidance Assist detects vehicles approaching from the rear left or right while your vehicle is reversing and warns you of a possible collision with a warning message and a warning sound. Also, Rear Cross-Traffic Collision-Avoidance Assist may assist with braking your vehicle to help avoid a collision.

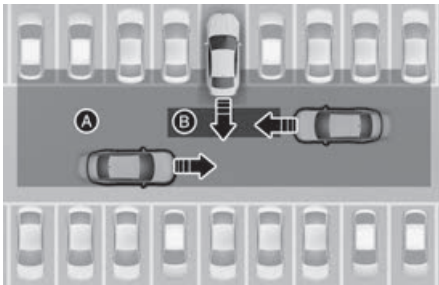

- [A] Rear Cross-Traffic Collision Warning operating range
- [B] Rear Cross-Traffic Collision-Avoidance Assist operating range

CAUTION

Warning timing may vary depending on the speed of the approaching vehicle.

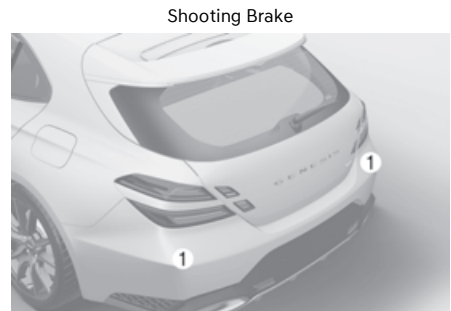
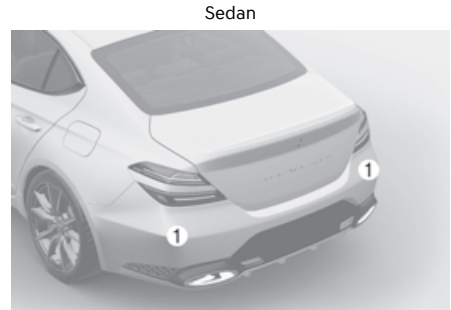

(1) Rear corner radar

See the illustration above for the detailed location of the detecting sensors.

i Information

For more information on the precautions of the rear corner radar, refer to the “Blind-Spot Collision-Avoidance Assist (BCA)” section in this chapter.

Rear Cross-Traffic Collision-Avoidance Assist settings

Rear Cross-Traffic Safety

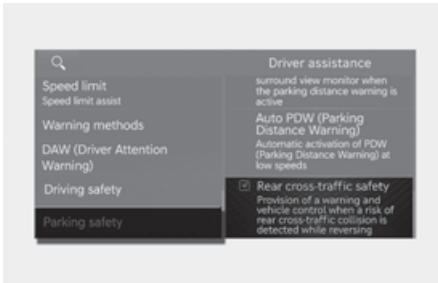

With the engine on, select **Setup (Settings) > Vehicle > Driver assistance > Parking safety > Rear cross-traffic safety** in the infotainment system to turn on Rear Cross-Traffic Collision-Avoidance Assist and deselect to turn off the function.

i Information

The infotainment system may change after software updates. For more information, refer to the manual provided in the infotainment system and the quick reference guide.

! WARNING

When the engine is restarted, Rear Cross-Traffic Collision-Avoidance Assist will always turn on. However, if “Off” is selected after the engine is restarted, the driver should always be aware of the surroundings and drive safely.

Warning methods



The Warning methods can be set with the engine on.

- **Warning volume:** Select **Setup (Settings) > Vehicle > Driver assistance > Warning methods > Warning volume** from the settings menu in the infotainment system to change the warning volume. (if equipped)
- **Haptic warning:** Select **Setup (Settings) > Vehicle > Driver assistance > Warning methods > Haptic warning** from the Settings menu in the infotainment system to set haptic warning. (if equipped)

i Information

The infotainment system may change after software updates. For more information, refer to the manual provided in the infotainment system and the quick reference guide.

i Information

- If you change the Warning Methods, the Warning Methods of other Driver Assistance systems may change.
- The **Warning volume** and **Haptic warning** cannot be turned off at the same time. When one of the warning is turned off the other is activated. (if equipped)
- If the engine is restarted, Warning Methods will maintain the last setting.
- The setting menu may not exist based on vehicle specification.

Rear Cross-Traffic Collision-Avoidance Assist operation

Collision Warning

Rear Cross-Traffic Collision-Avoidance Assist will warn and help control the vehicle depending on collision risk level: “Collision Warning”, “Emergency Braking” and “Stopping vehicle and ending brake control”.



Sedan

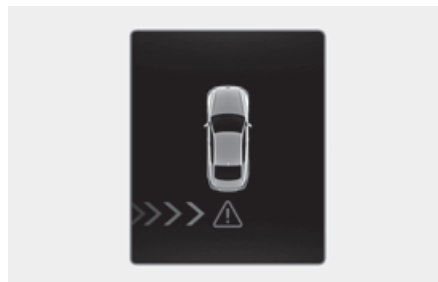

Shooting Brake

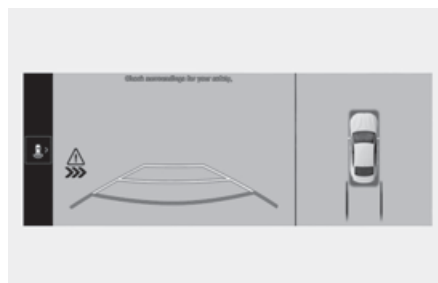
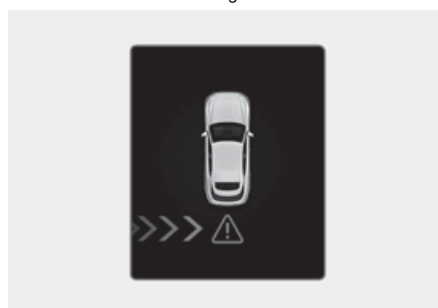

To warn the driver of an approaching vehicle from the rear left/right side of your vehicle, the warning light on the outside rearview mirror will blink and a warning will appear on the cluster. At the same time, an audible warning will sound and the steering wheel will vibrate. Rear View Monitor is operating, a warning will also appear on the infotainment system.

Rear Cross-Traffic Collision-Avoidance Assist will operate when all the following conditions are satisfied:

- The gear is shifted to R (Reverse)
- Vehicle speed is below 8 km/h (5 mph)
- The approaching vehicle is within about 25 m (82 ft) from the left and right side of your vehicle
- The speed of the vehicle approaching from the left and right is above 5 km/h (3 mph)

i Information

- If the operating conditions are satisfied, there will be a warning whenever the vehicle approaches from the left or right side even though your vehicle speed is 0 km/h (0 mph).
- The images and colors in the cluster may differ depending on the cluster type or theme selected from the cluster.

Emergency Braking

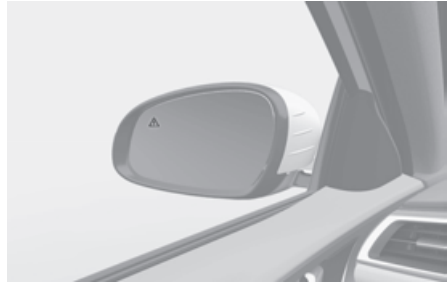

Sedan

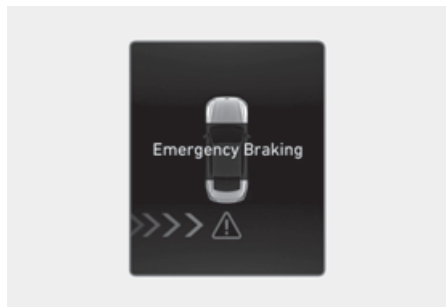

Shooting Brake

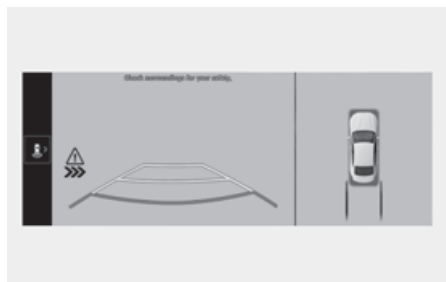
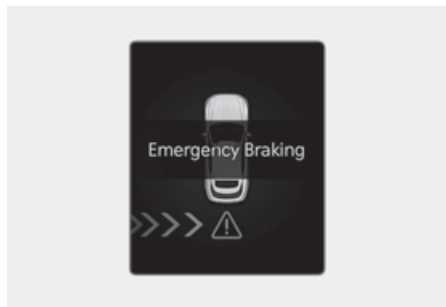

To warn the driver of an approaching vehicle from the rear left/right side of your vehicle, the warning light on the outside rearview mirror will blink and a warning message will appear on the instrument cluster. At the same time, an audible warning will sound. A warning will also appear on the infotainment system.

Rear Cross-Traffic Collision-Avoidance Assist will operate when all the following conditions are satisfied:

- The gear is shifted to R (Reverse)
- Vehicle speed is below 8 km/h (5 mph)
- The approaching vehicle is within about 1.5 m (5 ft) from the left and right side of your vehicle
- The speed of the vehicle approaching from the left and right is above 5 km/h (3 mph)
- Emergency braking will be assisted to help prevent collision with approaching vehicles from the left and right.

WARNING

Brake control will end when:

- The approaching vehicle is out of the detecting range
- The approaching vehicle passes behind your vehicle
- The approaching vehicle does not drive toward your vehicle
- The approaching vehicle speed slows down
- The driver depresses the brake pedal with sufficient power

Stopping vehicle and ending brake control

Sedan

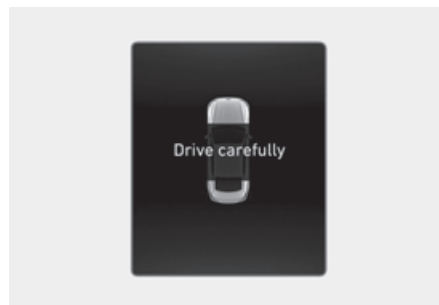

Shooting Brake

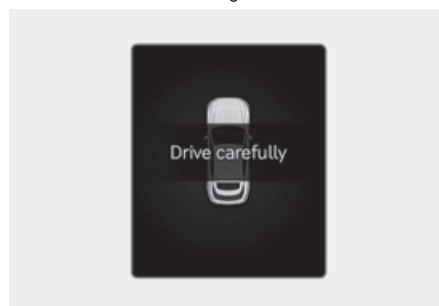

When the vehicle is stopped due to emergency braking, the **"Drive carefully"** warning message will appear on the cluster.

For your safety, the driver should depress the brake pedal immediately and check the surroundings.

- Brake control will end after the vehicle is stopped by emergency braking for about 2 seconds.
- During emergency braking, braking control by Rear Cross-Traffic Collision-Avoidance Assist will automatically cancel when the driver excessively depresses the brake pedal.

WARNING

Take the following precautions when using Rear Cross-Traffic Collision-Avoidance Assist:

- For your safety, only change the Settings after parking the vehicle at a safe location.
- If any other system's warning message appears or audible warning is generated, Rear Cross-Traffic Collision-Avoidance Assist warning message may not be displayed and audible warning may not be generated.
- You may not hear the warning sound of Rear Cross-Traffic Collision-Avoidance Assist if the surrounding is noisy.
- Rear Cross-Traffic Collision-Avoidance Assist may not operate if the driver applies the brake pedal to avoid collision.
- During Rear Cross-Traffic Collision-Avoidance Assist operation, the vehicle may stop suddenly injuring passengers and shifting loose objects. Always have the seat belt on and keep loose objects secured.
- Even if there is a problem with Rear Cross-Traffic Collision-Avoidance Assist, the vehicle's basic braking performance will operate properly.
- When Rear Cross-Traffic Collision-Avoidance Assist is operating, braking control by the function will automatically cancel when the driver excessively depresses the accelerator pedal.
- Rear Cross-Traffic Collision-Avoidance Assist does not operate in all situations or cannot avoid all collisions.
- Rear Cross-Traffic Collision-Avoidance Assist may warn the driver late or may not warn the driver depending on the road and driving conditions.
- The driver has the responsibility to control the vehicle. Do not solely depend on Rear Cross-Traffic

Collision-Avoidance Assist. Rather, maintain a safe braking distance, and if necessary, depress the brake pedal to reduce driving speed or to stop the vehicle.

- Never deliberately operate Rear Cross-Traffic Collision-Avoidance Assist on people, animal, objects, etc. It may cause serious injury or death.
-

CAUTION

The brake control may not operate properly depending on the status of ESC (Electronic Stability Control).

There will only be a warning when:

- The ESC (Electronic Stability Control) warning light is on
 - ESC (Electronic Stability Control) is engaged in a different function
-

Information

If braking is assisted by Rear Cross-Traffic Collision-Avoidance Assist, the driver must immediately depress the brake pedal and check vehicle surroundings.

- Brake control will end when the driver depresses the brake pedal with sufficient power.
 - After shifting the gear to R (Reverse), braking control will operate once for left and right vehicle approach.
-

Rear Cross-Traffic Collision-Avoidance Assist malfunction and limitations

Rear Cross-Traffic Collision-Avoidance Assist malfunction

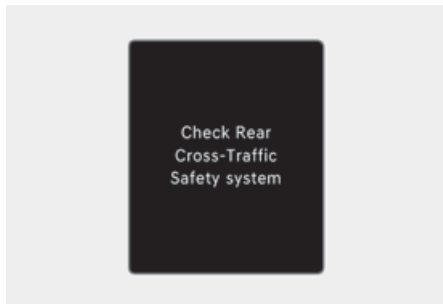

When Rear Cross-Traffic Collision-Avoidance Assist is not working properly, the "**Check Rear Cross-Traffic Safety system(s)**" warning message will appear on the cluster for several seconds, and the master (⚠) warning light will illuminate on the cluster. If this occurs, we recommend that the vehicle be inspected by an authorized retailer of Genesis Branded products.

Type A

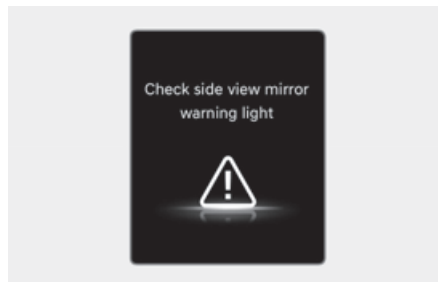

Type B

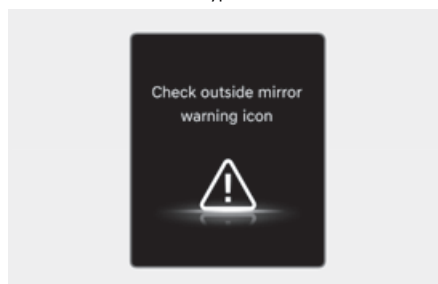

When the outside rearview mirror warning light is not working properly, the "**Check side view mirror warning light**" (or "**Check outside mirror warning icon**") warning message will appear on the cluster for several seconds, and the master (⚠) warning light will illuminate on the cluster. If this occurs, we recommend that the vehicle be inspected by an authorized retailer of Genesis Branded products.

Rear Cross-Traffic Collision-Avoidance Assist disabled

Type A

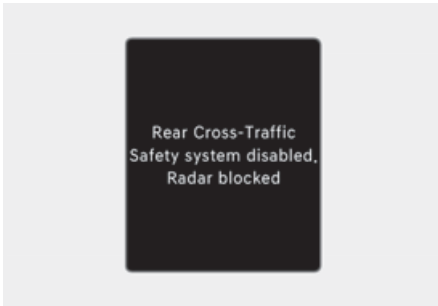

Type B

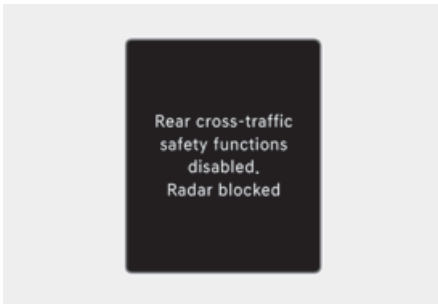

When the rear bumper around the rear-side radar or sensor is covered with foreign material, such as snow or rain, or installing a trailer or carrier, it can reduce the detecting performance and temporarily limit or disable Rear Cross-Traffic Collision-Avoidance Assist.

If this occurs, the "**Rear Cross-Traffic Collision-Avoidance Assist disabled. Radar blocked**" (or "**Rear cross-traffic safety functions disabled. Radar blocked**") warning message will appear on the cluster.

Rear Cross-Traffic Collision-Avoidance Assist will operate properly when such foreign material or trailer, etc., is removed.

If Rear Cross-Traffic Collision-Avoidance Assist does not operate properly after it is removed, we recommend that the vehicle be inspected by an authorized retailer of Genesis Branded products.

! WARNING

- Even though the warning message does not appear on the cluster, Rear Cross-Traffic Collision-Avoidance Assist may not operate properly.
- Rear Cross-Traffic Collision-Avoidance Assist may not operate properly in an area (for example, open terrain), where any substance are not detected after turning ON the vehicle.

! CAUTION

Turn off Rear Cross-Traffic Collision-Avoidance Assist to install or remove a trailer, carrier, or another attachment. Turn on Rear Cross-Traffic Collision-Avoidance Assist when finished.

Limitations of Rear Cross-Traffic Collision-Avoidance Assist

Rear Cross-Traffic Collision-Avoidance Assist may not operate properly, or it may operate unexpectedly under the following circumstances:

- Departing from where trees or grass are overgrown
- Departing from where roads are wet
- Speed of the approaching vehicle is fast or slow

Braking control may not work, driver's attention is required in the following circumstances:

- The vehicle severely vibrates while driving over a bumpy road, uneven road or concrete patch
- Driving on a slippery surface due to snow, water puddle, ice, etc.
- The tire pressure is low or a tire is damaged
- The brake is tuned
- Remote Smart Parking Assist is operating (if equipped)

i Information

For more information on the limitations of the rear corner radar, refer to the "Blind-Spot Collision-Avoidance Assist (BCA)" section in this chapter.

WARNING

- **Driving near a vehicle or structure**

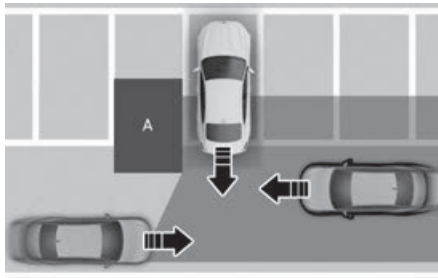

[A] Structure

Rear Cross-Traffic Collision-Avoidance Assist may be limited when driving near a vehicle or structure, and may not detect the vehicle approaching from the left or right. If this occurs, the function may not warn the driver or control the brakes when necessary.

Always check your surroundings while backing up.

- **When the vehicle is in a complex parking environment**

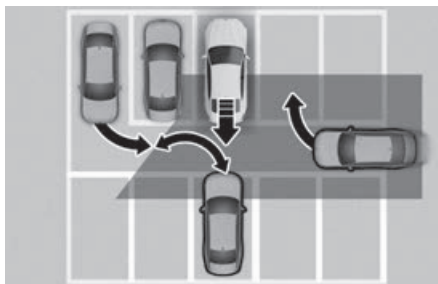

Rear Cross-Traffic Collision-Avoidance Assist may detect vehicles which are parking or pulling out near your vehicle (example, a vehicle leaving beside your vehicle, a vehicle parking or pulling out in the rear area, a vehicle approaching your vehicle making a turn, etc.). If this occurs, the function may unnecessarily warn the driver and control the brake.

Always check your surroundings while backing up.

- **When the vehicle is parked diagonally**

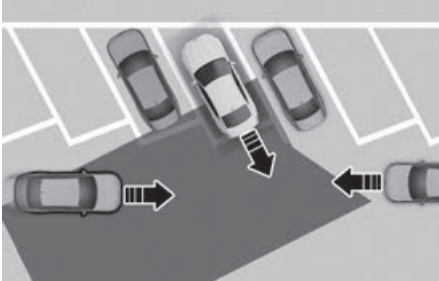

Rear Cross-Traffic Collision-Avoidance Assist may be limited when backing up diagonally, and may not detect the vehicle approaching from the left or right. If this occurs, the function may not warn the driver or control the brakes when necessary.

Always check your surroundings while backing up.

- **When the vehicle is on or near a slope**

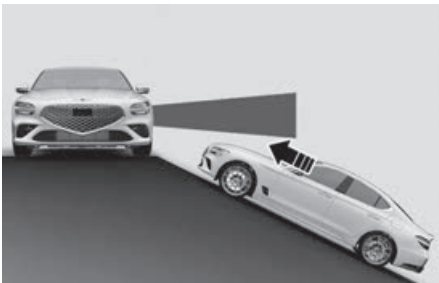

Rear Cross-Traffic Collision-Avoidance Assist may be limited when the vehicle is on an uphill or downhill slope, or near it, and may not detect the vehicle approaching from the left or right. If this occurs, the function may not warn the driver or control the brakes when necessary.

Always check your surroundings while backing up.

- **Pulling into the parking space where there is a structure**

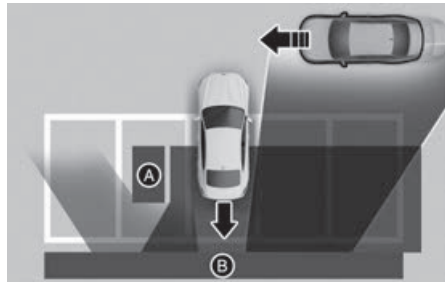

[A] Structure
[B] Wall

Rear Cross-Traffic Collision-Avoidance Assist may detect vehicles passing by in front of you when parking in reverse into a parking space with a wall or structure in the rear or side area. If this occurs, the function may unnecessarily warn the driver and control the brake.

Always check your surroundings while backing up.

- **When the vehicle is parked rearward**

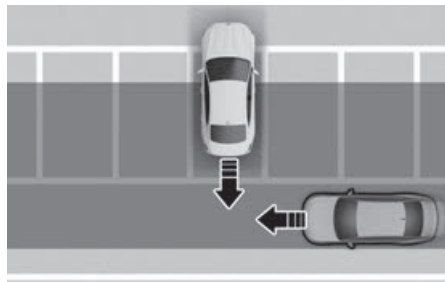

Rear Cross-Traffic Collision-Avoidance Assist may detect vehicles passing by behind you when parking in reverse into a parking space. If this occurs, the function may unnecessarily warn the driver and control the brake.

Always check your surroundings while backing up.

WARNING

- When you are towing a trailer or another vehicle, turn off Rear Cross-Traffic Collision-Avoidance Assist for safety reasons.
- Rear Cross-Traffic Collision-Avoidance Assist may not operate properly if interfered by strong electromagnetic waves.
- Rear Cross-Traffic Collision-Avoidance Assist may not operate for 3 seconds after the vehicle is started, or the rear corner radars are initialized.

Reverse Parking Distance Warning (PDW)

 if equipped

Reverse Parking Distance Warning uses the rear ultrasonic sensors to detect and warns you if a person, animal, or object is within a certain distance when your vehicle is stopped or driving at low speed.

Detecting sensor

Sedan



Shooting Brake



(1) Rear ultrasonic sensors

See the illustration above for the detailed location of the detecting sensors.

Reverse Parking Distance Warning settings

Warning methods

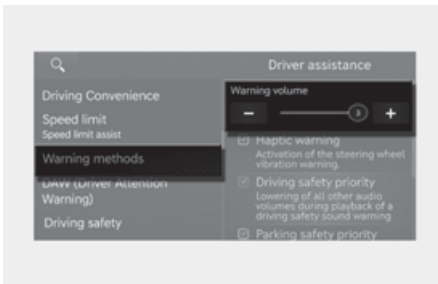

The Warning methods can be set with the engine on.

- **Warning volume:** Select **Setup (Settings) > Vehicle > Driver assistance > Warning methods > Warning volume** from the settings menu in the infotainment system to change the warning volume.

If you turn off the **Warning volume**, Parking Distance Warning will not turn off but the volume will sound as "Low".

i Information

- If you change the Warning methods, the Warning methods of other Driver assistance systems may change.
- If the engine is restarted, Warning methods will maintain the last setting.
- The setting menu may not exist depending on the vehicle specification.
- The infotainment system may change after software updates. For more information, refer to the manual provided in the infotainment system and the quick reference guide.

Reverse Parking Distance Warning operation

- Reverse Parking Distance Warning will activate when backing up with the Engine Start/Stop button in the ON position. However, if vehicle speed exceeds 5 km/h (3 mph), Reverse Parking Distance Warning may not detect objects.
- If vehicle speed exceeds 10 km/h (6 mph), Reverse Parking Distance Warning will not warn you even though objects are detected.
- When more than two objects are sensed at the same time, the closest one will be recognized first.



Reverse Parking Distance Warning

Reverse Parking Distance Warning will operate under the following conditions.

- The gear is shifted to R (Reverse).

i Information

Reverse Parking Distance Warning will operate when the vehicle's reverse speed is below 10 km/h (6 mph).

Distance from object	Warning indicator when driving rearward	Warning sound
	Cluster	
60-120 cm (24-48 in.)		Buzzer beeps intermittently
30-60 cm (12-24 in.)		Buzzer beeps frequently
within 30 cm (12 in.)		Beeps continuously

- The corresponding indicator will illuminate whenever each ultrasonic sensor detects a person, animal or object in its sensing range. Also an audible warning will sound.
- When more than two objects are detected at the same time, the closest one will be warned with an audible warning.
- The shape of the indicator in the illustration may differ from the actual vehicle.

Reverse Parking Distance Warning malfunction and limitations

Reverse Parking Distance Warning malfunction

After starting the vehicle, a beep will sound when the gear is shifted to R (Reverse) to indicate Parking Distance Warning is operating properly.

However, if one or more of the following occurs, first check whether the ultrasonic sensor is damaged or blocked with foreign material. If it still does not work properly, we recommend that the vehicle be inspected by an authorized retailer of Genesis Branded products.

- The audible warning does not sound.
- The buzzer sounds intermittently.
- The "**Parking sensor Error or blockage**" warning message appears on the cluster.

Sedan

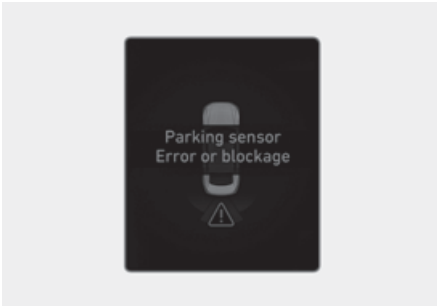

Shooting Brake



Limitations of Reverse Parking Distance Warning

- Forward/Reverse Parking Distance Warning may not operate properly when:
 - Moisture is frozen to the sensor
 - Sensor is covered with foreign substance, such as snow or water (Forward/Reverse Parking Distance Warning will operate properly when such substance is removed.)
 - The weather is extremely hot or cold
 - The sensor or sensor assembly is disassembled
 - The surface of the sensor is pressed hard or hit with a hard object
 - The surface of the sensor is scratched with a sharp object
 - The sensors or its surrounding area is directly sprayed with high pressure washer
- Forward/Reverse Parking Distance Warning may malfunction when:
 - Heavy rain or water spray is present
 - Water flows on the surface of the sensor
 - Affected by another vehicle's sensors
 - The sensor is covered with snow or ice
 - Driving on uneven road, gravel roads or bushes
 - Objects that generates ultrasonic waves are near the sensor
 - License plate is installed in a different spot from the original location
 - The vehicle bumper height or ultrasonic sensor installation has been modified
 - Attaching equipment or accessories next to the ultrasonic sensors

- The following objects may not be detected:
 - Sharp or slim objects, such as ropes, chains or small poles.
 - Narrow objects, such as corners of a square pillar
 - Objects, which tend to absorb sensor frequency, such as clothes, spongy material or snow.
 - Objects smaller than 100 cm (40 in.) in length and narrower than 14 cm (6 in.) in diameter.
 - Pedestrians, animals or objects that are very close to the ultrasonic sensors
- Parking Distance Warning Indicators may appear differently from the actual detected location when the obstacle is located between the sensors.
- Parking Distance Warning indicator may not occur sequentially depending on vehicle speed or obstacle shape.
- If Forward/Reverse Parking Distance Warning needs repair, we recommend that the vehicle be inspected by an authorized retailer of Genesis Branded products.

WARNING

- Parking Distance Warning is a supplemental function. The operation of Parking Distance Warning can be affected by several factors (including environmental conditions). It is the responsibility of the driver to always check the front and rear views before and while parking.
- Your new vehicle warranty does not cover any accidents or damage to the vehicle due to the malfunction of Parking Distance Warning.
- Pay close attention when driving near objects, pedestrians, and especially children. Some objects may not be detected by the ultrasonic sensors, due to the objects distance, size or material, all of which can limit the effectiveness of the sensor.
- Parking Distance Warning does not warn you in the order of detection. It varies depending on the speed of the vehicle or the shape of a person, animal, or object.
- If the Parking Distance Warning does not operate properly, we recommend that your vehicle be inspected by an authorized retailer of Genesis Branded products.

Forward/Reverse Parking Distance Warning (PDW)

 If equipped

Forward/Reverse Parking Distance Warning uses the front and rear ultrasonic sensors to detect and warns you if a person, animal, or object is within a certain distance when your vehicle is stopped or driving at low speed.

Detecting sensor



Sedan



Shooting Brake

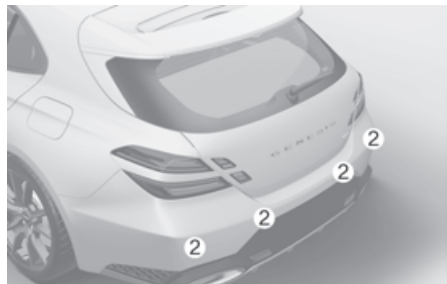

- (1) Front ultrasonic sensors
- (2) Rear ultrasonic sensors

See the illustration above for the detailed location of the detecting sensors.

Forward/Reverse Parking Distance Warning settings

Warning methods



The Warning methods can be set with the engine on.

- **Warning volume:** Select **Setup (Settings) > Vehicle > Driver assistance > Warning methods > Warning volume** from the settings menu in the infotainment system to change the warning volume.

If you turn off the **Warning volume**, Parking Distance Warning will not turn off but the volume will sound as **Low**.

i Information

- If you change the Warning methods, the Warning methods of other Driver assistance systems may change.
- If the engine is restarted, Warning methods will maintain the last setting.
- The setting menu may not exist depending on the vehicle specification.
- The infotainment system may change after software updates. For more information, refer to the manual provided in the infotainment system and the quick reference guide.

Forward/Reverse Parking Distance Warning operation

Parking Safety button



- Press the Parking Safety (P) button to turn on Forward/Reverse Parking Distance Warning. Press the button again to turn off the function.
- When the gear is shift to R (Reverse), Parking Distance Warning will automatically turn on (Parking Safety button indicator on).
- When Forward/Reverse Parking Distance Warning turns on, the button indicator light will turn on. If the vehicle speed is above 30 km/h (18 mph), Forward/Reverse Parking Distance Warning will turn off (button indicator light off).

Auto PDW (Parking Distance Warning)

To use **Auto PDW (Parking Distance Warning)** function, select **Setup (Settings) > Vehicle > Driver assistance > Parking safety > Auto PDW (Parking Distance Warning)** from the settings menu in the infotainment system.

i Information

- When **Auto PDW (Parking Distance Warning)** is selected, the Parking Safety button indicator (P⁺) stays on.
- The infotainment system may change after software updates. For more information, refer to the manual provided in the infotainment system and the quick reference guide.

Forward Parking Distance Warning



Forward Parking Distance Warning will operate when one of the condition is satisfied.

- The gear is shifted from R (Reverse) to D (Drive) with Reverse Parking Distance Warning on
- The gear is in D (Drive) and the Parking Safety button indicator light is on
- Shift to D (Drive) when the function is off (Only when **Setup (Settings) > Vehicle > Driver assistance > Parking safety > Auto PDW (Parking Distance Warning)** is selected from the settings menu in the infotainment system.)

i Information

- Forward Parking Distance Warning will operate only when the vehicle's forward speed is below 10 km/h (6 mph).
- The front outer side warnings turn on when the gear is in R (Reverse).

- Forward Parking Distance Warning is deactivated if the vehicle speed reaches above 30 km/h (18 mph). It will not reactivate although the vehicle speed drops below 10 km/h (6 mph). (Only when **Setup (Settings) > Vehicle > Driver assistance > Parking safety > Auto PDW (Parking Distance Warning)** is not selected from the settings menu in the infotainment system.)

Distance from object	Warning indicator when driving forward	Warning sound
	Cluster Infotainment	
60-100 cm (24-40 in.)		Buzzer beeps intermittently (Only when detected in the front center area)
30-60 cm (12-24 in.)		Beeps more frequently
within 30 cm (12 in.)		Beeps continuously

- The corresponding indicator will illuminate whenever each ultrasonic sensor detects a person, animal or object in its sensing range. Also an audible warning will sound.

- When more than two objects are detected at the same time, the closest one will be warned with an audible warning.
- The shape of the indicator in the illustration may differ from the actual vehicle.

i Information

The infotainment system may change after software updates. For more information, refer to the manual provided in the infotainment system and the quick reference guide.



Reverse Parking Distance Warning

Reverse Parking Distance Warning will operate under the following conditions.

- The gear is shifted to R (Reverse).
- When the vehicle's rearward speed is below 10 km/h (6 mph), both the front and rear ultrasonic sensors will help detect objects. However, the front ultrasonic sensors can help detect a person, animal or object when it is within 60 cm (24 in.) from the sensors.

i Information

Reverse Parking Distance Warning will operate when the vehicle's reverse speed is below 10 km/h (6 mph).

Distance from object	Warning indicator when driving rearward	Warning sound
	Cluster	
60-120 cm (24-48 in.)		Buzzer beeps intermittently
30-60 cm (12-24 in.)		Buzzer beeps frequently
within 30 cm (12 in.)		Beeps continuously

- The corresponding indicator will illuminate whenever each ultrasonic sensor detects a person, animal or object in its sensing range. Also an audible warning will sound.
- When more than two objects are detected at the same time, the closest one will be warned with an audible warning.
- The shape of the indicator in the illustration may differ from the actual vehicle.

Forward/Reverse Parking Distance Warning malfunction and limitations

Forward/Reverse Parking Distance Warning malfunction

After starting the vehicle, a beep will sound when the gear is shifted to R (Reverse) to indicate Forward/Reverse Parking Distance Warning is operating properly.

However, if one or more of the following occurs, first check whether the ultrasonic sensor is damaged or blocked with foreign material. If it still does not work properly, we recommend that the vehicle be inspected by an authorized retailer of Genesis Branded products.

- The audible warning does not sound.
- The buzzer sounds intermittently.
- The "**Parking sensor Error or blockage**" warning message appears on the cluster.

Sedan

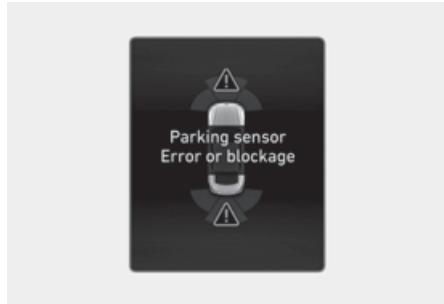

Shooting Brake

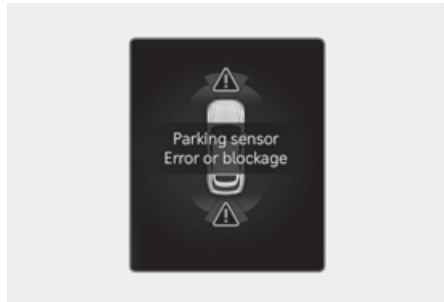

Limitations of Forward/Reverse Parking Distance Warning

- Forward/Reverse Parking Distance Warning may not operate properly when:
 - Moisture is frozen to the sensor
 - Sensor is covered with foreign substance, such as snow or water (Forward/Reverse Parking Distance Warning will operate properly when such substance is removed.)
 - The weather is extremely hot or cold
 - The sensor or sensor assembly is disassembled
 - The surface of the sensor is pressed hard or hit with a hard object
 - The surface of the sensor is scratched with a sharp object
 - The sensors or its surrounding area is directly sprayed with high pressure washer
- Forward/Reverse Parking Distance Warning may malfunction when:
 - Heavy rain or water spray is present
 - Water flows on the surface of the sensor
 - Affected by another vehicle's sensors
 - The sensor is covered with snow or ice
 - Driving on uneven road, gravel roads or bushes
 - Objects that generates ultrasonic waves are near the sensor
 - License plate is installed in a different spot from the original location
 - The vehicle bumper height or ultrasonic sensor installation has been modified
 - Attaching equipment or accessories next to the ultrasonic sensors
- The following objects may not be detected:
 - Sharp or slim objects, such as ropes, chains or small poles.
 - Narrow objects, such as corners of a square pillar
 - Objects, which tend to absorb sensor frequency, such as clothes, spongy material or snow.
 - Objects smaller than 100 cm (40 in.) in length and narrower than 14 cm (6 in.) in diameter.
 - Pedestrians, animals or objects that are very close to the ultrasonic sensors
- Parking Distance Warning Indicators may appear differently from the actual detected location when the obstacle is located between the sensors.
- Parking Distance Warning indicator may not occur sequentially depending on vehicle speed or obstacle shape.
- If Forward/Reverse Parking Distance Warning needs repair, we recommend that the vehicle be inspected by an authorized retailer of Genesis Branded products.



WARNING

- Parking Distance Warning is a supplemental function. The operation of Parking Distance Warning can be affected by several factors (including environmental conditions). It is the responsibility of the driver to always check the front and rear views before and while parking.
 - Your new vehicle warranty does not cover any accidents or damage to the vehicle due to the malfunction of Parking Distance Warning.
 - Pay close attention when driving near objects, pedestrians, and especially children. Some objects may not be detected by the ultrasonic sensors, due to the objects distance, size or material, all of which can limit the effectiveness of the sensor.
 - Parking Distance Warning does not warn you in the order of detection. It varies depending on the speed of the vehicle or the shape of a person, animal, or object.
 - If the Parking Distance Warning does not operate properly, we recommend that your vehicle be inspected by an authorized retailer of Genesis Branded products.
-

Declaration of conformity

 if equipped

Front radar

The radio frequency components complies:

- For Europe and CE certified countries



- For China

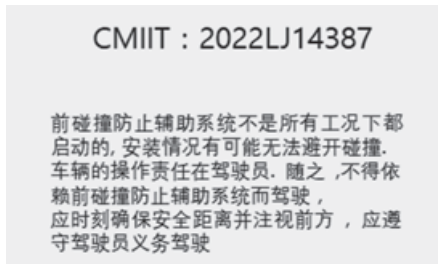

- For Taiwan



- For Japan

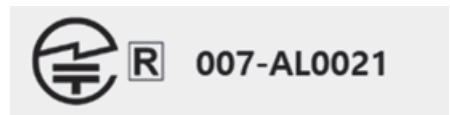

- For United Kingdom



- For Uzbekistan



- For Korea



- For UAE



- For Brazil



- For Oman

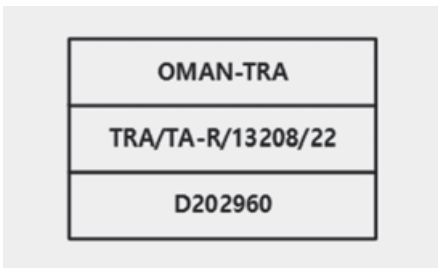

- For Singapore



- For Jordan

TRC/31/9733/2022

- For Mexico

IFT : RCPHLMR22-2322

- For Israel

תדירות דרוש מעט המאה רישוי רפסמ : 55-11765
 לש תדירות ותוספת תא תגשיל ידכ קרב שיש רישומב תולוע ענבל חסיא לה
 זה ללכב, רישומה
 אלב, תגשיל תגטאל רוביחל תרשפא תפסות או תירוקמ תגטוא תפלה, תגבס יוניש
 רישוי תלבק
 תדירותל תגטרול שטחה לשב, תדירותה דרוש.

- For Republic of South Africa

TA-2021/3154

APPROVED

Rear corner radar

The radio frequency components complies:

- For Taiwan

 **CCAE16LP0330T1**

電信法第 48 條. 低功率電波輻射性電機管理辦法

第十二條

經型式認證合格之低功率射頻電機，非經許可，公司、商號或使用者均不得擅自變更頻率、加大功率或變更原設計之特性及功能。

第十四條

低功率射頻電機之使用不得影響飛航安全及干擾合法通信；經發現有干擾現象時，應立即停用，並改善至無干擾時方得繼續使用。前項合法通信，指依電信法規定作業之無線電通信。低功率射頻電機須忍受合法通信或工業、科學及醫療用電波輻射性電機設備之干擾。

Article 12

Without permission, any company, firm or user shall not alter the frequency, increase the power, or change the characteristics and functions of the original design of the certified lower power frequency electric machinery.

Article 14

The application of low power frequency electric machineries shall not affect the navigation safety nor interface a legal communication, if an interference is found, the service will be suspended until improvement is made and the interference no longer exist.

- For Malaysia



- For Singapore



- For Mongolia

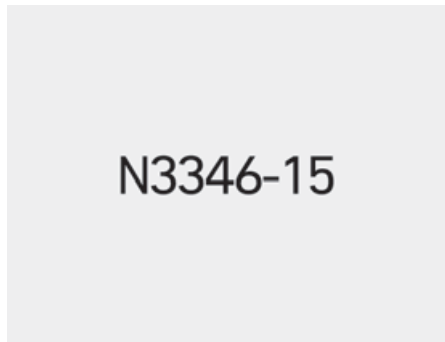

- For Philippine



- For Vietnam



- For Brazil



01924-16-08884

Este equipamento opera em caráter secundário, isto é, não tem direito à proteção contra interferência prejudicial, mesmo de estações do mesmo tipo, e não pode causar interferência a sistemas operando em caráter primário.

- For Mexico

IFETEL: RLWAMB15-2026

“La operación de este equipo está sujeta a las siguientes dos condiciones:
 (1) es posible que este equipo o dispositivo no cause interferencia perjudicial y (2) este equipo o dispositivo debe aceptar cualquier interferencia, incluyendo la que pueda causar su operación no deseada.”

- For Paraguay

PARAGUAY



CONATEL

NR:2016-12-1-000337

- For Ukraine



Valeo Schalter und Sensoren GmbH заявляє, що тип радіообладнання MBHL2 відповідає технічним регламентам радіотехнічного обладнання; повний текст декларації від відповідності доступна на веб-сайті за адресою: <https://valeo.com/declaration-of-conformity/files/MBHL2_DoC_TR-RED_WUE.PDF>

- For Moldova

Valeo Schalter si Sensoren GmbH declară că tipul de echipament radio MBHL2 este conform cu reglementările tehnice ale echipamentului radio.
 Textul complet al declarației de conformitate este disponibil pe site-ul:
[https://valeo.com/declaration-of-conformity/files/MBHL2_EU_DoC_\(RED_200811\)_ \(MD_Anexa1_210301\).pdf](https://valeo.com/declaration-of-conformity/files/MBHL2_EU_DoC_(RED_200811)_ (MD_Anexa1_210301).pdf)

- For Uzbekistan



- For Algeria

Agréé par l'ARPT:
<1248/1-LG409/DTDG/ARPT/18>

- For Jordan

TRC No. TRC/LPD/2015/365

- For Oman

OMAN-TRA
TRA/TA-032279
D080134

- For UAE

TRA REGISTERED No: ER44274/16
DEALER No: DA45088/15

- For Indonesia

57467/SDPPI/2018 1437

- For Mozambique

Approval No : N 2/R/SRS/2018
Valeo MBHL 2 Radar

- For Zambia

 ZICTA ZMB/ZICTA/TA/2018/4/24

- For Argentina



CNC ID : C-202016

- For Jamaica

This product contains a Type Approved Module by Jamaica: SMA – "MBHL2"

- For Europe and CE certified countries

Declaration of Conformity
Radiocontrolled Vehicle components



The radio frequency components of the vehicle comply with requirements and other relevant provisions of Directive 1995/5/EC.

Further information including the manufacturer's declaration of conformity is available on as follow ;
<https://valeo.com/declaration-of-conformity>

- For United Kingdom

Frequency : 24.05-24.25GHz
Max ERP(Peak) : 16.85 dBm

Simplified UK Declaration of Conformity

Hereby, Valeo Schalter & Sensoren GmbH declares that the radio equipment type MBHL2 is in compliance with the Radio Equipment Regulation 2017. The full text of the UK declaration of conformity is available at the following internet address :

https://www.valeo.com/declaration-of-conformity/files/MBHL2_UK_Doc_7_7_2021_parsif_FSD_11_8_2020.pdf

- For Korea

- 1.상호 : 발레오오토모티브코리아(주)
- 2.기기명칭 및 모델명 : 특정소출력 무선기기 (차량 충돌방지용 레이더 무선기기) / MHBL2
- 3.제조사 및 제조국가: 발레오오토모티브코리아/ 한국

8. Emergency situations

Hazard warning flasher	8-3
In case of an emergency while driving	8-3
If the engine stalls while driving	8-3
If the engine stalls at a crossroad or crossing	8-3
If you have a flat tire while driving	8-4
If the engine will not start	8-4
Jump starting	8-5
If the engine overheats	8-8
Tire Pressure Monitoring System (TPMS)	8-9
Check tire pressure	8-10
Tire pressure monitoring system	8-10
Low tire pressure warning light	8-11
Low tire pressure position and tire pressure telltale	8-11
TPMS (Tire Pressure Monitoring System) malfunction indicator	8-12
Changing a tire with TPMS	8-13
If you have a flat tire (with spare tire)	8-14
Jack and tools	8-14
Changing tires	8-16
Jack label	8-20
EC declaration of conformity for jack	8-21
If you have a flat tire (with Tire Mobility Kit)	8-22
Introduction	8-23
Notes on the safe use of the Tire Mobility Kit	8-23
Components of the Tire Mobility Kit	8-25
Using the Tire Mobility Kit When a tire is flat	8-26
How to adjust tire pressure	8-29
Towing	8-30
Towing service	8-30
Removable towing hook	8-31
Emergency towing	8-32
Emergency commodity	8-34
Fire extinguisher	8-34
First aid kit	8-34
Triangle reflector	8-34
Tire pressure gauge	8-35

Pan-European E-Call system (For Europe) 8-36
Information on data processing 8-39
Pan-European E-Call system 8-40

Hazard warning flasher

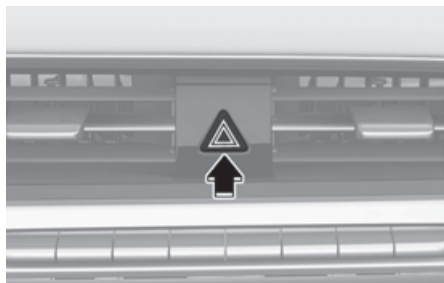

The hazard warning flasher serves as a warning to other drivers to exercise extreme caution when approaching, overtaking, or passing your vehicle.

It should be used whenever emergency repairs are being made or when the vehicle is stopped near the edge of a roadway.

To turn the hazard warning flasher on or off, press the hazard warning flasher button with the Engine Start/Stop button in any position. The hazard warning flasher button is located in the center fascia panel. All turn signal lights will flash simultaneously.

- The hazard warning flasher operates regardless of whether your vehicle is running or not.
- The turn signals do not work when the hazard flasher is on.

In case of an emergency while driving

If the engine stalls while driving

- Reduce your speed gradually, keeping a straight line. Move cautiously off the road to a safe place.
- Turn on your hazard warning flasher.
- Try to start the engine again. If your vehicle will not start, we recommend that you contact an authorized retailer of Genesis Branded products or seek other qualified assistance.

If the engine stalls at a crossroad or crossing

If the engine stalls at a crossroads or crossing, if safe to do so, shift the gear to N (Neutral) and then push the vehicle to a safe location.

To stay N (Neutral) while the vehicle is off, refer to the "To stay in N (Neutral) when vehicle is OFF" section in chapter 6.

If you have a flat tire while driving

If a tire goes flat while you are driving:

- Take your foot off the accelerator pedal and let the vehicle slow down while driving straight ahead. Do not apply the brakes immediately or attempt to pull off the road as this may cause loss of vehicle control resulting in an accident. When the vehicle has slowed to such a speed that it is safe to do so, brake carefully and pull off the road. Drive off the road as far as possible and park on firm, level ground. If you are on a divided highway, do not park in the median area between the two traffic lanes.
- When the vehicle is stopped, press the hazard warning flasher button, shift the gear to P (Park), apply the parking brake, and press the Engine Start/Stop button to the OFF position.
- Have all passengers get out of the vehicle. Be sure they all get out on the side of the vehicle that is away from traffic.
- When changing a flat tire, follow the instructions provided later in this chapter.

If the engine will not start

- Be sure to shift the gear to N (Neutral) or P (Park). The engine starts only when the gear is in N (Neutral) or P (Park).
- Turn on the interior light. If the light dims or goes out when you operate the starter, the battery is drained.

Refer to the instructions in the “Jump starting” section in this chapter.

- Check the fuel level and add fuel if necessary.

If the vehicle still does not start, we recommend that you call an authorized retailer of Genesis Branded products for assistance.

NOTICE

Starting the vehicle by pushing or pulling may cause the catalytic converter to overload and damage the emission control system.

Jump starting

Jump starting can be dangerous if done incorrectly. Follow the jump starting procedure in this section to avoid serious injury or damage to your vehicle. If in doubt about how to properly jump start your vehicle, we strongly recommend that you have a service technician or towing service do it for you.

WARNING

To prevent **SERIOUS INJURY** or **DEATH** to you or bystanders, always follow these precautions when working near or handling the battery:



Always read and follow instructions carefully when handling a battery.



Wear eye protection designed to protect the eyes from acid splashes.



Keep all flames, sparks, or smoking materials away from the battery.



Hydrogen is always present in battery cells, is highly combustible, and may explode if ignited.



Keep batteries out of reach of children.



Batteries contain sulfuric acid which is highly corrosive. Do not allow acid to contact your eyes, skin or clothing.

If acid gets into your eyes, flush your eyes with clean water for at least 15 minutes and get immediate medical attention. If acid gets on your skin, thoroughly wash the area. If you feel pain or a burning sensation, get medical attention immediately.

- When lifting a plastic-cased battery, excessive pressure on the case may cause battery acid to leak. Lift with a battery carrier or with your hands on opposite corners.
- Do not attempt to jump start your vehicle if your battery is frozen.
- Never attempt to recharge the battery when the vehicle's battery cables are connected to the battery.
- The electrical ignition system works with high voltage.
Never touch these components with the engine running or when the Engine Start/Stop button is in the ON position.
- Do not allow the positive (+) and negative (-) jumper cables to touch. It may cause sparks.

Jump starting procedure

i Information

Your vehicle has a battery in the luggage compartment, but when you jump start your vehicle, use the jumper terminal in the engine compartment.

1. Position the vehicles close enough that the jumper cables will reach, but do not allow the vehicles to touch.
2. Avoid fans or any moving parts in the engine compartment at all times, even when the vehicles are turned off.
3. Turn off all electrical devices such as radios, lights, air conditioning, etc. Put the vehicles in P (Park), and apply the parking brake. Turn both vehicles OFF.
4. Open the engine hood.
5. Remove the engine compartment fuse box cover.

! CAUTION

Before jump starting, make sure to correctly identify the positive (+) and negative (-) terminals to avoid reverse polarity connections.

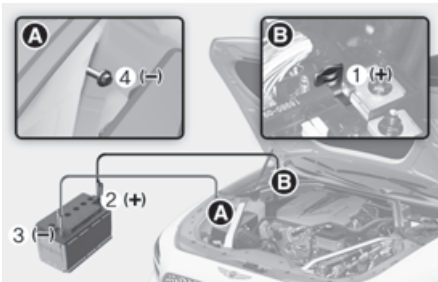

6. Connect the jumper cables in the exact sequence shown in the illustration. First connect one jumper cable to the red, positive (+) jumper terminal of your vehicle (1).
7. Connect the other end of the jumper cable to the red, positive (+) battery/jumper terminal of the assisting vehicle (2).
8. Connect the second jumper cable to the black, negative (-) battery/jumper terminal of the assisting vehicle (3).
9. Connect the other end of the second jumper cable to the black, negative (-) chassis ground of your vehicle (4).

Do not allow the jumper cables to contact anything except the correct battery or jumper terminals or the correct ground. Do not lean over the battery when making connections.

! WARNING

Do not connect the jumper cable to the negative (-) jumper terminal of the discharged battery. A spark could cause the battery to explode and lead to a personal injury or vehicle damage.

10. Start the engine of the assisting vehicle and let it run at about 2,000 rpm for a few minutes. Then start your vehicle.
11. Keep your vehicle operating for at least 30 minutes at idle or driving to assure your battery receives enough charge to be able to start on its own after the vehicle is shut off. A completely discharged battery may require as long as 60 minutes runtime to fully recharge it. If the vehicle has run for less, the vehicle may not restart.

If your vehicle will not start after a few attempts, it probably requires servicing. In this event please seek qualified assistance. If the cause of your battery discharging is not apparent, we recommend that you have your vehicle checked by an authorized retailer of Genesis Branded products.

Disconnect the jumper cables in the exact reverse order you connected them:

1. Disconnect the jumper cable from the black, negative (-) chassis ground of your vehicle (4).
2. Disconnect the other end of the jumper cable from the black, negative (-) battery/chassis ground of the assisting vehicle (3).
3. Disconnect the second jumper cable from the red, positive (+) battery/jumper terminal of the assisting vehicle (2).
4. Disconnect the other end of the jumper cable from the red, positive (+) jumper terminal of your vehicle (1).

i Information



An inappropriately disposed battery can be harmful to the environment and human health. Always dispose of a used battery according to your local law(s) or regulations.

NOTICE

To prevent damage to your vehicle:

- Only use a 12 V power supply (battery or jumper system) to jump start your vehicle.
- Do not attempt to jump start your vehicle by push-starting.

If the engine overheats

If your temperature gauge indicates overheating, you experience a loss of power, or hear loud pinging or knocking, the engine may be overheating. If this happens, you should:

1. Pull off the road and stop as soon as it is safe to do so.
2. Shift the gear to P (Park) and set the parking brake. If the air conditioning is ON, turn it OFF.
3. If engine coolant is running out under the vehicle or steam is coming out from the hood, stop the engine. Do not open the hood until the coolant has stopped running or the steaming has stopped. If there is no visible loss of engine coolant and no steam, leave the engine running and check to be sure the engine cooling fan is operating. If the fan is not running, turn the engine off.

WARNING



While the engine is running, keep hands, clothing and tools away from the moving parts such as the cooling fan and drive belt to prevent serious injury.

4. Check for coolant leaking from the radiator, hoses or under the vehicle. (If the air conditioning had been in use, it is normal for cold water to be draining from it when you stop.)
5. If engine coolant is leaking out, we recommend that you stop the engine immediately and call the nearest authorized retailer of Genesis Branded products for assistance.

WARNING



Never remove the engine coolant cap or the drain plug while the engine and radiator are hot.

Hot coolant and steam may blow out under pressure, causing serious injury. Turn the engine off and wait until the engine cools down. Use extreme care when removing the coolant cap. Wrap a thick towel around it, and turn it counterclockwise slowly to the first stop. Step back while the pressure is released from the cooling system. When you are sure all the pressure has been released, press down on the cap, using a thick towel, and continue turning counterclockwise to remove it.

6. If you cannot find the cause of the overheating, wait until the engine temperature has returned to normal. Then, if coolant has been lost, carefully add coolant to the reservoir to bring the fluid level in the reservoir up to the halfway mark.
7. Proceed with caution, keeping alert for further signs of overheating. If overheating happens again, we recommend that you call an authorized retailer of Genesis Branded products for assistance.

⚠ CAUTION

- Serious loss of coolant indicates a leak in the cooling system and we recommend the system be checked by an authorized retailer of Genesis Branded products.
- When the engine overheats from low engine coolant, suddenly adding engine coolant may cause cracks in the engine. To prevent damage, add engine coolant slowly in small quantities.

It may require several refilling cycles to properly fill the engine cooling system. If necessary, we recommend that you contact an authorized retailer of Genesis Branded products for assistance.

Tire Pressure Monitoring System (TPMS)



- (1) Low Tire Pressure Telltale/TPMS Malfunction Indicator
- (2) Low Tire Pressure Position Telltale and Tire Pressure Telltale (Shown on the cluster display)

Check tire pressure



- You can check the tire pressure on the cluster.
Refer to the “Cluster display (Type A)”, “Cluster display (Type B)” section in chapter 4.
- Tire pressure appears after a few minutes of driving after initial vehicle start up.
- If tire pressure is not displayed when the vehicle is stopped, **“Drive to display”** message will appear. After driving, check the tire pressure.
- The displayed tire pressure values may differ from those measured with a tire pressure gauge.
- You can change the tire pressure unit from the Settings menu in the infotainment system. Select:
 - **Setup (Settings) > General > Units > Tire Air Pressure Unit (Tyre pressure unit) > psi/kPa/bar**

i Information

The infotainment system may change after software updates. For more information, refer to the manual provided in the infotainment system and the quick reference guide.

Tire pressure monitoring system

WARNING

Over-inflation or under-inflation can reduce tire life, adversely affect vehicle handling, and lead to sudden tire failure that may cause loss of vehicle control resulting in an accident.

Each tire, including the spare (if provided), should be checked monthly when cold and inflated to the inflation pressure recommended by the vehicle manufacturer on the vehicle placard or tire inflation pressure label. (If your vehicle has tires of a different size than the size indicated on the vehicle placard or tire inflation pressure label, you should determine the proper tire inflation pressure for those tires.)

As an added safety feature, your vehicle has been equipped with a tire pressure monitoring system (TPMS) that illuminates a low tire pressure telltale when one or more of your tires is significantly under-inflated. Accordingly, when the low tire pressure telltale illuminates, you should stop and check your tires as soon as possible, and inflate them to the proper pressure. Driving on a significantly under-inflated tire causes the tire to overheat and can lead to tire failure.

Under-inflation also reduces fuel efficiency and tire tread life, and may affect the vehicle’s handling and stopping ability.

Please note that the TPMS is not a substitute for proper tire maintenance, and it is the driver’s responsibility to maintain correct tire pressure, even if under-inflation has not reached the level to trigger illumination of the TPMS low tire pressure telltale.

Your vehicle has also been equipped with a TPMS malfunction indicator to indicate when the system is not operating properly. The TPMS malfunction indicator is combined with the low tire pressure telltale. When the system detects a malfunction, the telltale will flash for about one minute and then remain continuously illuminated. This sequence will continue upon subsequent vehicle start-ups as long as the malfunction exists.

When the malfunction indicator is illuminated, the system may not be able to detect or signal low tire pressure as intended. TPMS malfunctions may occur for a variety of reasons, including the installation of replacement or alternate tires or wheels on the vehicle that prevent the TPMS from functioning properly.

Always check the TPMS malfunction telltale after replacing one or more tires or wheels on your vehicle to ensure that the replacement or alternate tires and wheels allow the TPMS to continue to function properly.

NOTICE

If any of the below happens, we recommend that you have the system checked by an authorized retailer of Genesis Branded products.

1. The Low Tire Pressure Telltale/ TPMS Malfunction Indicator does not illuminate for 3 seconds when the Engine Start/Stop button is pressed to the ON position or when the engine is running.
2. The TPMS Malfunction Indicator remains illuminated after blinking for about 1 minute.
3. The Low Tire Pressure Position Telltale remains illuminated.

Low tire pressure warning light



Low tire pressure position and tire pressure telltale



When the tire pressure monitoring system warning indicators illuminate and the warning message displayed on the cluster display, one or more of your tires is significantly under-inflated. The Low Tire Pressure Position Telltale will indicate which tire is significantly under-inflated by illuminating the corresponding position light.

If either telltale illuminates, immediately reduce your speed, avoid hard cornering and anticipate increased stopping distances. You should stop and check your tires as soon as possible. Inflate the tires to the proper pressure as indicated on the vehicle's placard or tire inflation pressure label located on the driver's side center pillar outer panel.

If you cannot reach a service station or if the tire cannot hold the newly added air, replace the low pressure tire with the spare tire.

The Low Tire Pressure Telltale will remain on and the TPMS Malfunction Indicator may blink for one minute and then remain illuminated (when the vehicle is driven about 10 minutes at speed above 25 km/h (15.5 mph)) until you have the low pressure tire repaired and replaced on the vehicle.

CAUTION

In winter or cold weather, the Low Tire Pressure Telltale may be illuminated if the tire pressure was adjusted to the recommended tire inflation pressure in warm weather. It does not mean your TPMS is malfunctioning because the decreased temperature may lead to a proportional lowering of tire pressure.

When you drive your vehicle from a warm area to a cold area or from a cold area to a warm area, or the outside temperature is greatly higher or lower, you should check the tire inflation pressure and adjust the tires to the recommended tire inflation pressure.

WARNING

Low pressure damage

Significantly low tire pressure makes the vehicle unstable and can contribute to loss of vehicle control and increased braking distances.

Continued driving on low pressure tires can cause the tires to overheat and fail.

TPMS (Tire Pressure Monitoring System) malfunction indicator



The TPMS Malfunction Indicator will illuminate after it blinks for about one minute when there is a problem with the Tire Pressure Monitoring System.

We recommend that the system be checked by an authorized retailer of Genesis Branded products as soon as possible.

NOTICE

If there is a malfunction with the TPMS, the Low Tire Pressure Position Telltale will not be displayed even though the vehicle has an under-inflated tire.

NOTICE

The TPMS Malfunction Indicator may illuminate after blinking for one minute if the vehicle is near electric power supply cables or radio transmitters such as police stations, government and public offices, broadcasting stations, military installations, airports, transmitting towers, etc.

Additionally, the TPMS Malfunction Indicator may illuminate if snow chains are used or electronic devices such as computers, chargers, remote starters, navigation, etc. This may interfere with normal operation of the TPMS.

Changing a tire with TPMS

If you have a flat tire, the Low Tire Pressure and Position telltales will come on. We recommend that the flat tire be repaired by an authorized retailer of Genesis Branded products as soon as possible or replace the flat tire with the spare tire.

NOTICE

It is recommended that you do not use a puncture-repairing agent not approved by an authorized retailer of Genesis Branded products or the equivalent specified for your vehicle to repair and/or inflate a low pressure tire. Tire sealant not approved by an authorized retailer of Genesis Branded or the equivalent specified for your vehicle may damage the tire pressure sensor.

The spare tire (if equipped) does not come with a tire pressure monitoring sensor. When the low pressure tire or the flat tire is replaced with the spare tire, the Low Tire Pressure Telltale will remain on. Also, the TPMS Malfunction Indicator will illuminate after blinking for one minute if the vehicle is driven at speed above 25 km/h (15.5 mph) for about 10 minutes.

Once the original tire equipped with a tire pressure monitoring sensor is reinflated to the recommended pressure and reinstalled on the vehicle, the Low Tire Pressure Telltale and TPMS Malfunction Indicator will go off within a few minutes of driving.

If the indicators do not extinguish after a few minutes, please visit an authorized retailer of Genesis Branded products.

Each wheel is equipped with a tire pressure sensor mounted inside the tire behind the valve stem (except for the spare tire). You must use TPMS specific wheels. It is recommended that you always have your tires serviced by an authorized retailer of Genesis Branded products.

You may not be able to identify a tire with low pressure by simply looking at it. Always use a good quality tire pressure gauge to measure. Please note that a tire that is hot (from being driven) will have a higher pressure measurement than a tire that is cold.

A cold tire means the vehicle has been sitting for 3 hours and driven for less than 1.6 km (1 mile) in that 3 hour period.

Allow the tire to cool before measuring the inflation pressure. Always be sure the tire is cold before inflating to the recommended pressure.

WARNING

- The TPMS cannot alert you to severe and sudden tire damage caused by external factors such as nails or road debris.
- If you feel any vehicle instability, immediately take your foot off the accelerator, apply the brakes gradually with light force, and slowly move to a safe position off the road.

⚠ WARNING

Tampering with, modifying, or disabling the Tire Pressure Monitoring System (TPMS) components may interfere with the system's ability to warn the driver of low tire pressure conditions and/or TPMS malfunctions. Tampering with, modifying, or disabling the Tire Pressure Monitoring System (TPMS) components may void the warranty for that portion of the vehicle.

⚠ WARNING

For Europe

- Do not modify the vehicle; it may interfere with the TPMS function.
- The wheels on the market do not have a TPMS sensor.

For your safety, we recommend that you use parts for replacement from an authorized retailer of Genesis Branded products.

- If you use the wheels on the market, use a TPMS sensor approved by an authorized retailer of Genesis Branded products or the equivalent approved for your vehicle. If your vehicle is not equipped with a TPMS sensor or TPMS does not work properly, you may fail the periodic vehicle inspection conducted in your country.

If you have a flat tire (with spare tire)

+ If equipped

⚠ WARNING

Changing a tire can be dangerous. Follow the instructions in this section when changing a tire to reduce the risk of serious injury or death.

⚠ CAUTION

Be careful as you use the jack handle to stay clear of the flat end. The flat end has sharp edges that could cause cuts.

Jack and tools

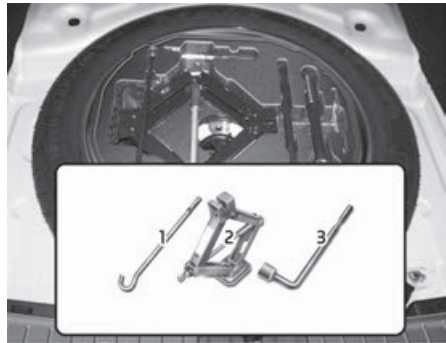

- (1) Jack handle
- (2) Jack
- (3) Wheel lug wrench

The jack, jack handle, and wheel nut wrench are stored in the luggage compartment under the luggage box cover.

The jack is provided for emergency tire changing only.



Turn the winged hold down bolt counterclockwise to remove the spare tire.

Store the spare tire in the same compartment by turning the winged hold down bolt clockwise.

To prevent the spare tire and tools from “rattling”, store them in their proper location.



If it is hard to loosen the tire hold-down wing bolt by hand, you can loosen it easily using the jack handle.

1. Put the jack handle (1) inside of the tire hold-down wing bolt.
2. Turn the tire hold-down wing bolt counterclockwise with the jack handle.

WARNING



Do not touch luggage room metal surface while the engine is operating or hot.

Doing so could result in serious personal injury.

Turn the engine off and wait until it cools down or wear gloves to remove the spare tire from the luggage room.

Changing tires

WARNING

A vehicle can slip or roll off of a jack causing serious injury or death to you or those nearby. Take the following safety precautions:

- Do not get under a vehicle that is supported by a jack.
- Never attempt to change a tire in the lane of traffic. Always move the vehicle completely off the road on level, firm ground away from traffic before trying to change a tire. If you cannot find a level, firm place off the road, call a towing service for assistance.
- Be sure to use the jack provided with the vehicle.
- Always place the jack on the designated jacking positions on the vehicle and Never on the bumpers or any other part of the vehicle for jacking support.
- Do not start or run the engine while the vehicle is on the jack.
- Do not allow anyone to remain in the vehicle while it is on the jack.
- Keep children away from the road and the vehicle.

Follow these steps to change your vehicle's tire:

1. Park on a level, firm surface.
2. Shift the gear to P (Park), apply the parking brake, and press the Engine Start/Stop button to the OFF position.
3. Press the hazard warning flasher button.
4. Remove the wheel lug wrench, jack, jack handle, and spare tire from the vehicle.
5. Block both the front and rear of the tire diagonally opposite of the tire you are changing.

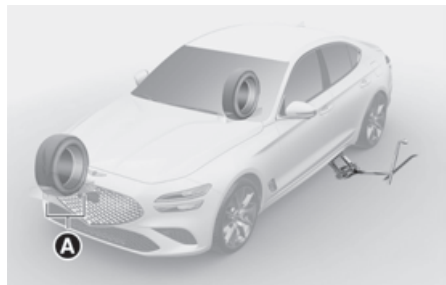

[A] Block

6. Loosen the wheel lug nuts counterclockwise one turn each in the order shown below, but do not remove any wheel lug nuts until the tire has been raised off of the ground.



7. Place the jack at the designated jacking position under the frame closest to the tire you are changing. The jacking positions are plates welded to the frame with two notches. Never jack at any other position or part of the vehicle. Doing so may damage the side seal molding or other parts of the vehicle.

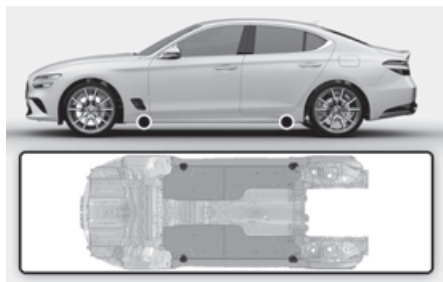

8. Insert the jack handle into the jack and turn it clockwise, raising the vehicle until the tire clears the ground. Make sure the vehicle is stable on the jack.



9. Loosen the lug nuts with the wheel lug nut wrench and remove them with your fingers. Remove the wheel from the studs and lay it flat on the ground out of the way. Remove any dirt or debris from the studs, mounting surfaces, and wheel.
10. Install the spare tire onto the studs of the hub.
11. Tighten the lug nuts with your fingers onto the studs with the smaller end of the lug nuts closest to the wheel.

12. Lower the vehicle to the ground by turning the jack handle counterclockwise.
13. Use the wheel lug nut wrench to tighten the lug nuts in the order shown. Double-check each lug nut until they are tight. After changing tires, we recommend that an authorized retailer of Genesis Branded products tighten the lug nuts to their proper torque as soon as possible. The wheel lug nut should be tightened to 11-13 kgf·m (79-94 lbf·ft).



Check the tire pressure after installing the compact spare tire. The compact spare tire should be inflated to 420 kPa (60 psi).

If you have a tire gauge, check the tire pressure (see “Tires and wheels” section in chapter 2 for tire pressure instructions.). If the pressure is lower or higher than recommended, drive slowly to the nearest service station and adjust it to the recommended pressure. Always reinstall the valve cap after checking or adjusting tire pressure. If the cap is not replaced, air may leak from the tire. If you lose a valve cap, buy another and install it as soon as possible. After changing tires, secure the flat tire and return the jack and tools to their proper storage locations.

NOTICE

Check the tire pressure as soon as possible after installing a spare tire. Adjust it to the recommended pressure.

CAUTION

Your vehicle has metric threads on the studs and wheel lug nuts. Make certain during tire changing that the same nuts that were removed are reinstalled. If you have to replace your wheel lug nuts make sure they have metric threads to avoid damaging the studs and ensure the wheel is properly secured to the hub. We recommend that you consult an authorized retailer of Genesis Branded products for assistance.

If any of the equipment such as the jack, wheel lug nuts, studs, or other equipment is damaged or in poor condition, do not attempt to change the tire and call for assistance.

Use of compact spare tires

 If equipped

Compact spare tires are designed for emergency use only. Drive carefully on the compact spare tire and always follow the safety precautions.

WARNING

To prevent compact spare tire failure and loss of control possibly resulting in an accident:

- Use the compact spare tire only in an emergency.
 - Never operate your vehicle over 80 km/h (50 mph).
 - Do not exceed the vehicle's maximum load rating or the load carrying capacity shown on the sidewall of the compact spare tire.
 - Do not use the compact spare tire continuously. Repair or replace the original tire as soon as possible to avoid failure of the compact spare tire.
-

When driving with the compact spare tire mounted to your vehicle:

- Check the tire pressure after installing the compact spare tire. The compact spare tire should be inflated to 420 kPa (60 psi).
- Do not take this vehicle through an automatic car wash while the compact spare tire is installed.
- Do not use the compact spare tire on any other vehicle because this tire has been designed especially for your vehicle.
- The compact spare tire's tread life is shorter than a regular tire. Inspect your compact spare tire regularly and replace worn compact spare tires with the same size and design, mounted on the same wheel.
- Do not use more than one compact spare tire at a time.
- Do not tow a trailer while the compact spare tire is installed.

i Information

When the original tire and wheel are repaired and reinstalled on the vehicle, the wheel lug nuts torque must be set correctly. The correct wheel lug nuts tightening torque is 11-13 kgf·m (79-94 lbf·ft).

NOTICE

To prevent damaging the compact spare tire and your vehicle:

- Drive slowly enough for the road conditions to avoid all hazards, such as a potholes or debris.
- Avoid driving over obstacles. The compact spare tire diameter is smaller than the diameter of a conventional tire and reduces the ground clearance about 25 mm (1 in.).
- Do not use tire chains on the compact spare tire. Because of the smaller size, a tire chain will not fit properly.
- Do not use the compact spare tire on any other wheels, nor should standard tires, snow tires, wheel covers or trim rings be used with the compact spare wheel.
- Do not suddenly accelerate or decelerate (0-40 km/h) (0-25 mph) in any driving mode. It may cause leakage of transfer oil.

Jack label

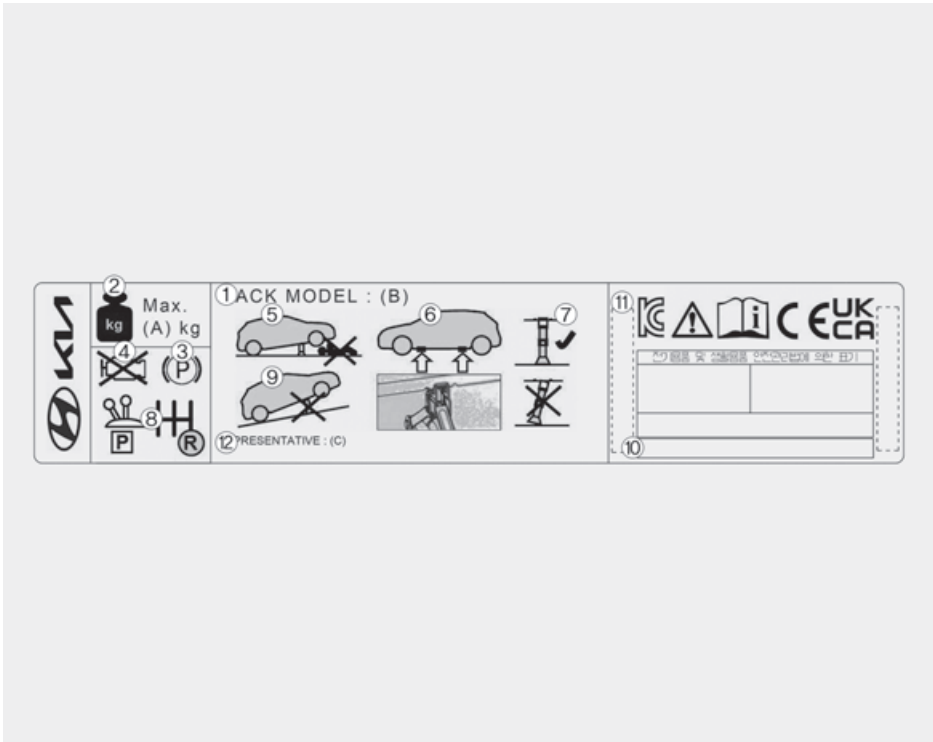

The actual Jack label in the vehicle may differ from the illustration.

- (1) Model Name
- (2) Maximum allowable load
- (3) When using the jack, set your parking brake.
- (4) When using the jack, stop the engine.
- (5) Do not get under a vehicle that is supported by a jack.
- (6) The designated locations under the frame
- (7) When supporting the vehicle, the base plate of jack must be vertical under the lifting point.
- (8) Shift into Reverse gear on vehicles with manual transmission or shift the gear to the P position on vehicles with automatic transmission.
- (9) The jack should be used on firm level ground.
- (10) Jack manufacture
- (11) Production date
- (12) Representative company and address

For more detailed specifications, refer to the label attached to the jack.

EC declaration of conformity for jack

ATTESTATION		
	Attestation of Conformity	
	<i>according to Machinery directive (2006/42/EC)</i>	
	Certificate No. CAZZP2092	
	Owner of Certificate	FRONTEC CO., LTD. 64 Huiyanggongwon-ro, Siheung-si, Gyeonggi-do, Korea
	Manufacturer	FRONTEC CO., LTD. 64 Huiyanggongwon-ro, Siheung-si, Gyeonggi-do, Korea
	Trademark	 Frontec Co.,Ltd.
	Product	JACK-ASSY
	Type/Model	1200KG, 1000KG, 800KG, 700KG, 500KG
	Reference Document	Technical construction file (Document No.: FTCE-130610-001 rev.4 / 22-04-2022)
<p>The product described above complies with the requirements of the Machinery Directive (2006/42/EC). The details about the product conformity and applied standards are mentioned in the technical file referenced above. This certificate is subject to Kiwa Korea Ltd. regulations and it is valid only for the above mentioned equipment.</p>		
Issue date	13-10-2022	
Last revised date	N/A	
Expiry date	12-10-2027	
Revision	0	
	<i>Kiwa Korea Lead Auditor</i> 	<i>Kiwa Korea General Manager</i> 
<p>Kiwa Korea Ltd. 411, SJ Technoville, 278, Beokko-ro, Gumcheon-gu, Seoul, Korea Tel: +82.2.3397.0101, Fax: + 82.2.3397.0105 E-mail: info@kiwa.kr, Web: www.kiwa.kr</p>		
		
<p>The CE marking may be used if all relevant and effective EC directives are complied with.</p>		

If you have a flat tire (with Tire Mobility Kit)

 If equipped

Sedan



Shooting Brake



- (1) Compressor
- (2) Sealant bottle

For safe operation, carefully read and follow the instructions in this manual before use.

The Tire Mobility Kit is a temporary fix to the tire and the tire should be inspected by an authorized retailer of Genesis Branded products or the equivalent approved for your vehicle as soon as possible.

CAUTION

When two or more tires are flat, do not use the tire mobility kit because the sealant provided with the Tire Mobility Kit must be used for only one flat tire.

WARNING

- Do not use the Tire Mobility Kit to repair punctures in the tire walls. This can result in an accident due to tire failure.
- Have your tire repaired as soon as possible. The tire may lose air pressure at any time after inflating with the Tire Mobility Kit.

Introduction

With the Tire Mobility Kit, you can keep the mobile even after experiencing a tire puncture.

The compressor and sealing compound system effectively and comfortably seals most punctures in a passenger car tire caused by nails or similar objects and reinflates the tire.

After you ensure that the tire is properly sealed, you can drive cautiously (distance up to 200 km (120 miles)) at a max. speed of 80 km/h (50 mph) in order to reach a service station or tire dealer for the tire replacement.

It is possible that some tires, especially with larger punctures or damage to the sidewall, cannot be sealed completely.

Air pressure loss in the tire may adversely affect tire performance.

For this reason, you should avoid abrupt steering or other driving maneuvers, especially if the vehicle is heavily loaded or if a trailer is in use. The Tire Mobility Kit is not designed or intended as a permanent tire repair method and is to be used for one tire only.

This instruction shows you how to temporarily seal the puncture simply and reliably. Read the section "Notes on the safe use of the Tire Mobility Kit".

Notes on the safe use of the Tire Mobility Kit

- Park your car at the side of the road so that you can work with the Tire Mobility Kit away from moving traffic.
- To be sure your vehicle will not move, even when you're on fairly level ground, always set your parking brake.
- Only use the Tire Mobility Kit for sealing/inflation passenger car tires. Only punctured areas located within the tread region of the tire can be sealed using the tire mobility kit.
- Do not use on motorcycles, bicycles or any other type of tires.
- When the tire and wheel are damaged, do not use Tire Mobility Kit for your safety.
- Use of the Tire Mobility Kit may not be effective for tire damage larger than about 4mm (0.16in.)

We recommend that you contact an authorized retailer of Genesis Branded products if the tire cannot be made roadworthy with the Tire Mobility Kit.

- Do not use the Tire Mobility Kit if a tire is severely damaged by driving run flat or with insufficient air pressure.
- Do not remove any foreign objects such as nails or screws that have penetrated the tire.

Emergency situations

- Provided the car is outdoors, leave the engine running. Otherwise operating the compressor may eventually drain the car battery.
- Never leave the Tire Mobility Kit unattended while it is being used.
- Do not leave the compressor running for more than 10 minutes at a time or it may overheat.
- Do not use the Tire Mobility Kit if the ambient temperature is below -30°C (-22°F).
- In case of skin contact with the sealant, wash the area thoroughly with plenty of water. If the irritation persists, seek medical attention.
- In case of eye contact with the sealant, flush your eyes for at least 15 minutes. If the irritation persists, seek medical attention.
- In case of swallowing the sealant, rinse the mouth and drink plenty of water. However, never give anything to an unconscious person and seek medical attention immediately.
- Long time exposure to the sealant may cause damage to bodily tissue such as kidney, etc.
- Only punctured areas located within the tread region of the tire can be sealed using the Tire Mobility Kit.

Components of the Tire Mobility Kit

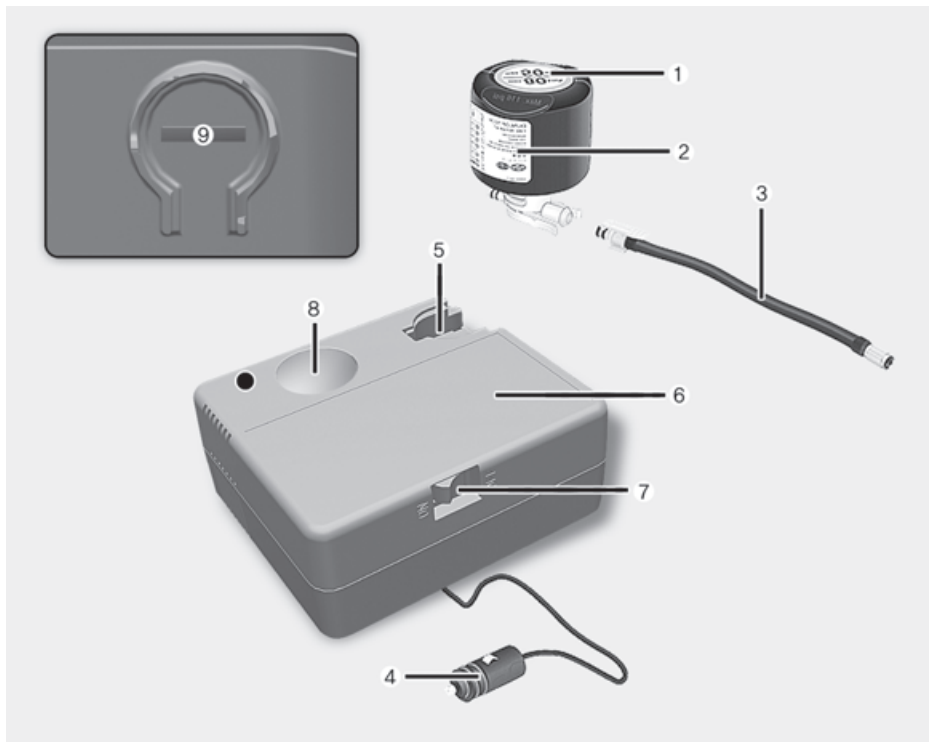

- (1) Speed restriction label
- (2) Sealant bottle and label with speed restriction
- (3) Filling hose
- (4) Connectors and cable for power outlet direct connection
- (5) Holder for the sealant bottle
- (6) Compressor
- (7) ON/OFF switch
- (8) Pressure gauge for displaying the tire inflation pressure
- (9) Button for reducing the tire inflation pressure

Connectors, cable and connection hose are stored in the compressor housing.

Strictly follow the specified sequence, otherwise the sealant may escape under high pressure.

⚠ WARNING

Do not use the tire sealant after the sealant has expired (i.e. expiration date on the sealant container). This can increase the risk of tire failure.

⚠ WARNING

Sealant

- Keep out of reach of children.
- Avoid contact with eyes.
- Do not swallow.

**Using the Tire Mobility Kit
When a tire is flat**

⚠ CAUTION



Detach the speed restriction label (1) from the sealant bottle (2), and place it in a highly visible place inside the vehicle such as on the steering wheel to remind the driver not to drive too fast.

⚠ CAUTION

If only the tire pressure needs to be adjusted, refer to the “How to adjust tire pressure” in this chapter.

Before using the Tire Mobility Kit, be fully aware of the explanation on the sealant.

1. Shake the sealant bottle.



2. Connect the filling hose (3) to the sealant bottle (2) in the direction of (A) and connect the sealant bottle to the holder for the sealant bottle (5) in the direction of (B).

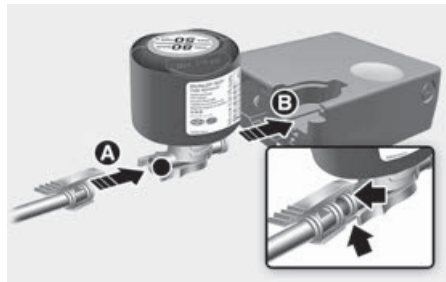

3. Ensure that the compressor is switched OFF.

4. Unscrew the valve cap from the valve of the defective wheel and screw the filling hose (3) of the sealant bottle onto the valve.



⚠ CAUTION

Securely install the sealant filling hose to the valve. If not, sealant may flow backward, possibly clogging the filling hose.

5. Plug the compressor power cord (4) into the vehicle power outlet.

**NOTICE**

Only use the front passenger side power outlet when connecting the power cord.

6. With the engine ON, switch on the compressor and let it run for about 5-7 minutes to fill the sealant up to proper pressure. (refer to the "Tires and wheels" section in chapter 2). The inflation pressure of the tire after filling is unimportant and will be checked/corrected later.

Be careful not to overinflate the tire and stay away from the tire when filling it.

⚠ CAUTION

Tire pressure

Do not attempt to drive your vehicle if the tire pressure is below 200 kPa (29 psi). This could result in an accident due to sudden tire failure.

7. Switch off the compressor.
8. Detach the hoses from the sealant bottle connector and from the tire valve.

Return the Tire Mobility Kit to its storage location in the vehicle.

⚠ WARNING

Carbon monoxide

Do not leave your vehicle running in a poorly ventilated area for extended periods of time. Carbon monoxide poisoning and suffocation can occur.

9. Immediately drive about 7-10 km (4-6 miles or, about 10min) to evenly distribute the sealant in the tire.

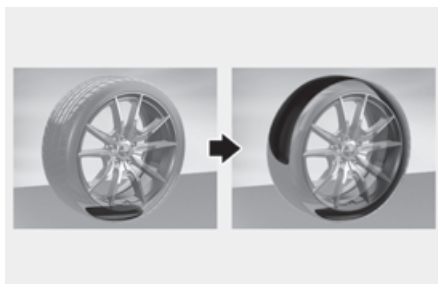

Do not exceed a speed of 80 km/h (50 mph). If possible, do not fall below a speed of 20 km/h (12 mph).

While driving, if you experience any unusual vibration, ride disturbance or noise, reduce your speed and drive with caution until you can safely pull off of the vehicle on the side of the road.

Call for road side service or towing.

10. After driving about 7-10 km (4-6 miles or about 10 min), stop at a safety location.
11. Connect the filling hose (3) of the compressor directly to the tire valve.



12. Plug the compressor power cord into the vehicle power outlet.
13. Adjust the tire inflation pressure to the recommended tire inflation.

With the engine running, proceed as follows.

- To increase the inflation pressure :
Switch on the compressor. To check the current inflation pressure setting, briefly switch off the compressor.
- To reduce the inflation pressure:
Press the button (9) on the compressor.

NOTICE

Do not let the compressor run for more than 10 minutes, otherwise the device will overheat and may be damaged.

***i* Information**

The pressure gauge may show higher than actual reading when the compressor is running. To get an accurate tire reading, the compressor needs to be turned off.

! CAUTION

- If the inflation pressure is not maintained, drive the vehicle a second time, refer to the step 9. Then repeat step 10-13.
- Use of the TMK may be ineffectual for tire damage larger than about 4 mm (0.16 in).

We recommend that you contact an authorized retailer of Genesis Branded products if the tire cannot be made roadworthy with the Tire Mobility Kit.

! WARNING

The tire inflation pressure must be at least 220 kPa (32 psi). If it is not, do not continue driving.

Call for road side service or towing.

! CAUTION

Tire pressure sensor

The sealant on the tire pressure sensor and wheel should be removed when you replace the tire with a new one and inspect the tire pressure sensors at an authorized dealer.

***i* Information**

When reinstalling the repaired or replaced tire and wheel on the vehicle, tighten the wheel lug nut to 11-13 kgf·m (79-94 lbf·ft).

How to adjust tire pressure



1. Park your vehicle in a safe location.
2. Connect the filling hose (3) of the compressor directly to the tire valve.
3. Plug the compressor power cord into the vehicle power outlet.
4. Adjust the tire inflation pressure to the recommended tire inflation.

With the engine Start/Stop button position on, proceed as follows.

- To increase the inflation pressure :
Switch on the compressor. To check the current inflation pressure setting, briefly switch off the compressor.
- To reduce the inflation pressure:
Press the button (9) on the compressor.

NOTICE

Do not let the compressor run for more than 10 minutes, otherwise the device will overheat and may be damaged.

i Information

The pressure gauge may show higher than actual reading when the compressor is running. To get an accurate tire reading, the compressor needs to be turned off.

CAUTION

Do not use the sealant when the tire pressure only needs to be adjusted.

WARNING

The tire inflation pressure must be inflated to the proper pressure, refer to the "Tires and wheels" section in chapter 2. If it is not inflated, do not continue to drive.

Call for road side service or towing.

Towing

Towing service

Flatbed Towing

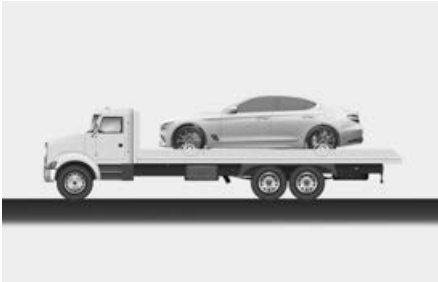

Wheel lift Towing

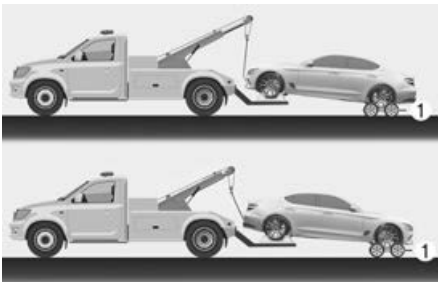

(1) Dollies

If emergency towing is necessary, we recommend having it done by an authorized retailer of Genesis Branded products or a commercial tow-truck service.

Proper lifting and towing procedures are necessary to prevent damage to the vehicle. The use of wheel dollies or flatbed is recommended.

For 2WD vehicles, it is acceptable to tow the vehicle with the front wheels on the ground (without dollies) and the rear wheels off the ground.

If any of the loaded wheels or suspension components are damaged or the vehicle is being towed with the rear wheels on the ground, use a towing dolly under the rear wheels.

When being towed by a commercial tow truck and wheel dollies are not used, the rear of the vehicle should always be lifted, not the front.

For AWD vehicles, it must be towed with a wheel lift and dollies or flatbed equipment with all the wheels off the ground.

NOTICE

Do not lift the vehicle by the tow fitting or body and chassis parts. Otherwise the vehicle may be damaged.

CAUTION

- Do not tow the vehicle with the rear wheels on the ground as this may cause damage to the vehicle.

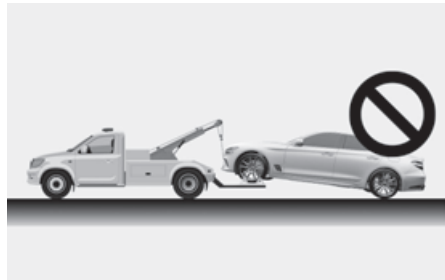

- Do not tow with sling-type equipment. Use wheel lift or flatbed equipment.

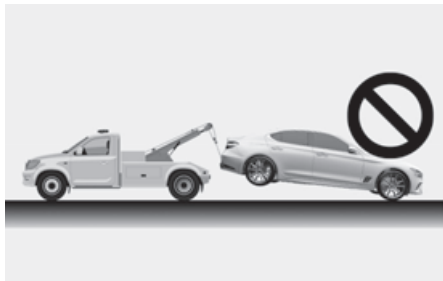

⚠ WARNING

If your vehicle is equipped with a rollover sensor, press the Engine Start/Stop button to the OFF or ACC position when the vehicle is being towed. The side impact and curtain airbag may deploy if the sensor detects the situation as a rollover.

When towing your vehicle in an emergency without wheel dollies:

1. Place the shift lever in N (Neutral).
2. Release the parking brake.

NOTICE

Failure to place the shift lever in N (Neutral) when being towed with the front wheels on the ground can cause internal damage to the transmission.

Removable towing hook

1. Open the trunk (or tailgate), and remove the towing hook from the tool case.

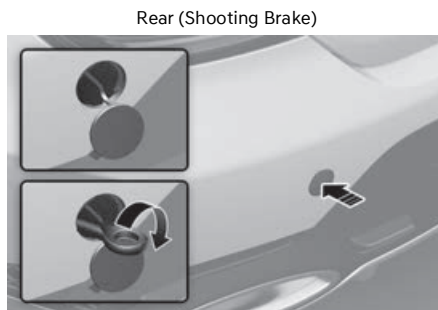
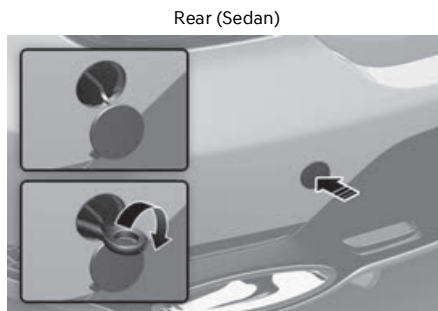
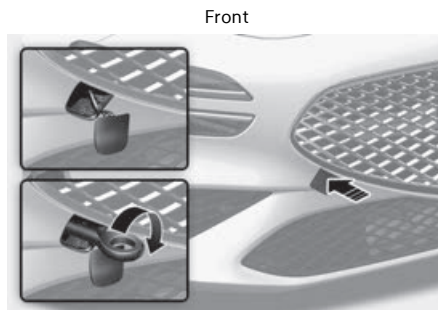

2. Remove the hole cover by pressing the lower part of the cover on the bumper.
3. Install the towing hook by turning it clockwise into the hole until it is fully secured.
4. Remove the towing hook and install the cover after use.

Emergency towing

Front

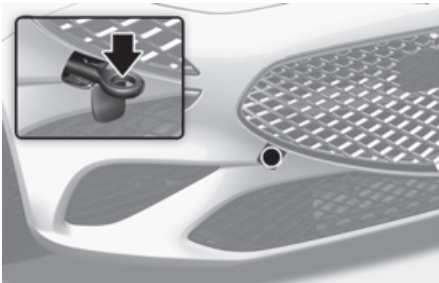

Rear (Sedan)



Rear (Shooting Brake)



If towing is necessary, we recommend you have it done by an authorized retailer of Genesis Branded products or a commercial tow truck service.

If a towing service is not available in an emergency, your vehicle may be temporarily towed using a cable or chain secured to the emergency towing hook at the front (or rear) of the vehicle.

Use extreme caution when towing the vehicle with a cable or chain. A driver must be in the vehicle to steer it and operate the brakes.

Towing in this manner may be done only on hard-surfaced roads for a short distance and at low speeds. Also, the wheels, axles, power train, steering and brakes must all be in good condition.

CAUTION

The driver must be in the vehicle for steering and braking operations when the vehicle is being towed. Passengers other than the driver must not be in the vehicle.

Always follow these emergency towing precautions:

- Press the Engine Start/Stop button to the ACC position so the steering wheel is not locked.
- Shift the gear to N (Neutral).
- Release the parking brake.
- Depress the brake pedal with more force than normal as you will have reduced braking performance.
- More steering effort will be required because the power steering system will be disabled.
- Use a vehicle heavier than your own to tow your vehicle.
- The drivers of both vehicles should communicate with each other frequently.
- Before emergency towing, check that the hook is not broken or damaged.
- Fasten the towing cable or chain securely to the hook.
- Do not jerk the hook. Apply steady and even force.

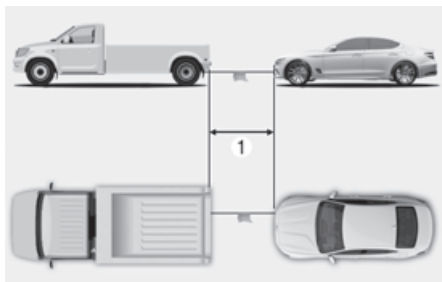

(1) 5 m

- Use a towing cable or chain less than 5 m (16 ft.) long. Attach a white or red cloth (about 30cm (12 inches) in width) in the middle of the cable or chain for easy visibility.
- Drive carefully so the towing cable or chain remains tight during towing.
- Before towing, check the automatic transmission for fluid leaks under your vehicle. If the automatic transmission fluid is leaking, flatbed equipment or a towing dolly must be used.

NOTICE

Accelerate or decelerate the vehicle in a slow and gradual manner while maintaining tension on the tow rope or chain to start or drive the vehicle, otherwise tow hooks and the vehicle may be damaged.

NOTICE

To avoid damage to your vehicle and vehicle components when towing:

- Always pull straight ahead when using the towing hooks. Do not pull from the side or at a vertical angle.
- Do not use the towing hooks to pull a vehicle out of mud, sand or other conditions from which the vehicle cannot be driven out under its own power.
- Limit the vehicle speed to 15 km/h (10 mph) and drive less than 1.5 km (1 mile) when towing to avoid serious damage to the automatic transmission.

Emergency commodity

 If equipped

Your vehicle is equipped with emergency commodities to help you respond to emergency situation.

Fire extinguisher

 If equipped

If there is small fire and you know how to use the fire extinguisher, follow these steps carefully.

1. Pull out the safety pin at the top of the extinguisher that keeps the handle from being accidentally pressed.
2. Aim the nozzle towards the base of the fire.
3. Stand about 2.5 m (8 ft) away from the fire and squeeze the handle to discharge the extinguisher. If you release the handle, the discharge will stop.
4. Sweep the nozzle back and forth at the base of the fire. After the fire appears to be out, watch carefully since it may re-ignite.

First aid kit

Supplies for use in giving first aid such as scissors, bandage and adhesive tape, etc. are provided.

Triangle reflector

 If equipped

Sedan



Shooting Brake

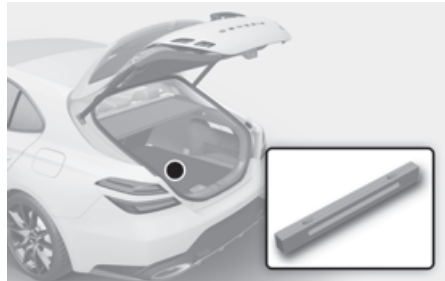

Place the triangle reflector on the road to warn oncoming vehicles during emergencies, such as when the vehicle is parked by the roadside due to problems.

Tire pressure gauge

 if equipped

Tires normally lose some air in day-to-day use, and you may have to add a air periodically and usually it is not a sign of a leaking tire, but of normal wear. Always check tire pressure when the tires are cold because tire pressure increases with temperature.

To check the tire pressure, take the following steps:

1. Unscrew the inflation valve cap that is located on the rim of the tire.
2. Press and hold the gauge against the tire valve. Some air will leak as you begin and more will leak if you don't press the gauge firmly.
3. A firm non-leaking push will activate the gauge.
4. Read the tire pressure on the gauge to see whether the tire pressure is low or high.
5. Adjust the tire pressure to the specified pressure. Refer to the "Tires and wheels" section in chapter 2.
6. Reinstall the inflation valve cap.

Pan-European E-Call system (For Europe)

 If equipped

The vehicle is equipped with a device* connected with the Pan-European E-Call system for making emergency call to response teams. The Pan-European E-Call system is an automatic emergency call service made in event of a traffic accident or other** accidents on the roads of Europe. (only in countries with regulation on this system)

The system allows contacting with an officer of the single duty dispatch service in case of accidents on the roads of Europe. (only in countries with regulation on this system)

The Pan-European E-Call system given conditions, stated in the Owner's Manual as well as Warranty and Service book transmits data to the Public Safety Answering Point (PSAP) including such information as vehicle location, vehicle type, VIN (vehicle identification number of the vehicle).

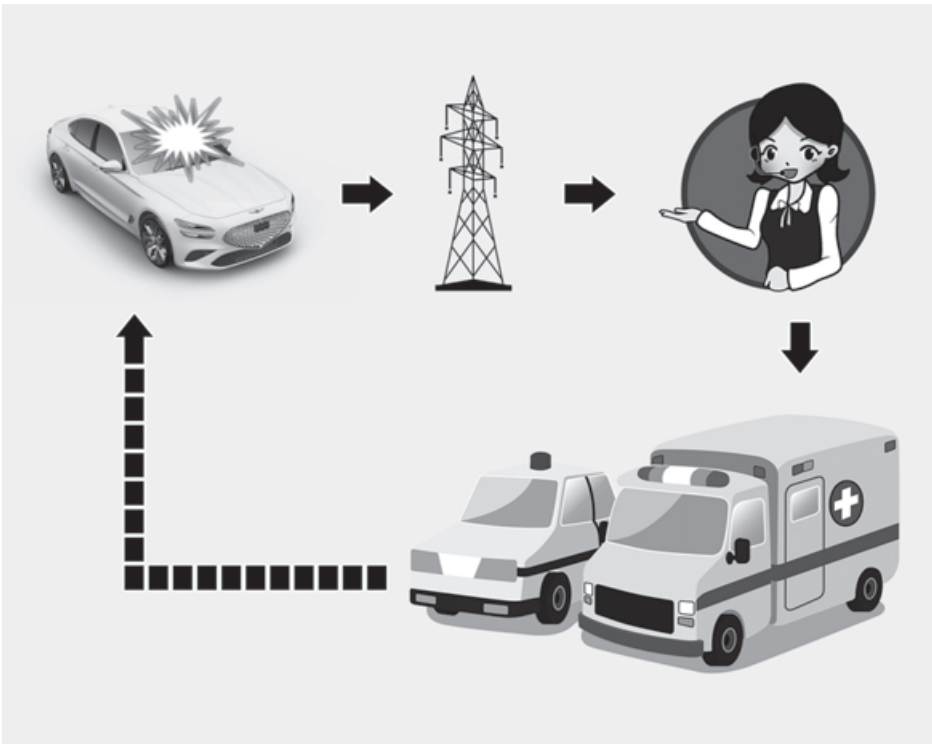

1. Road accident
2. Wireless network
3. Public Safety Answering Point (PSAP)
4. Rescue

i Information

Pan-European E-Call device in the Owner's Manual means equipment, installed in the vehicle, which provides connection with the Pan-European E-Call system.

"Other accidents" mean any accidents on the roads of Europe (only in countries with regulation on this system) resulted in injured people and/or necessity of provision of assistance. In case of registration of any accident, it is necessary to stop a vehicle, press button SOS (location of the button is specified on the picture in the chapter "Pan-European E-Call (if equipped)") of the Owner's Manual. When making a call, the system gathers information about the vehicle (from which a call was made), after which connects the car with an officer of the Public Safety Answering Point (PSAP) to tell about the reason of the emergency call.

Once the data which is stored in the Pan-European E-Call system is delivered to the rescue center to assist the driver and passengers with proper rescue operations, the data will be deleted after rescue operation is completed.

Description of the E-Call in-vehicle system (For Europe)

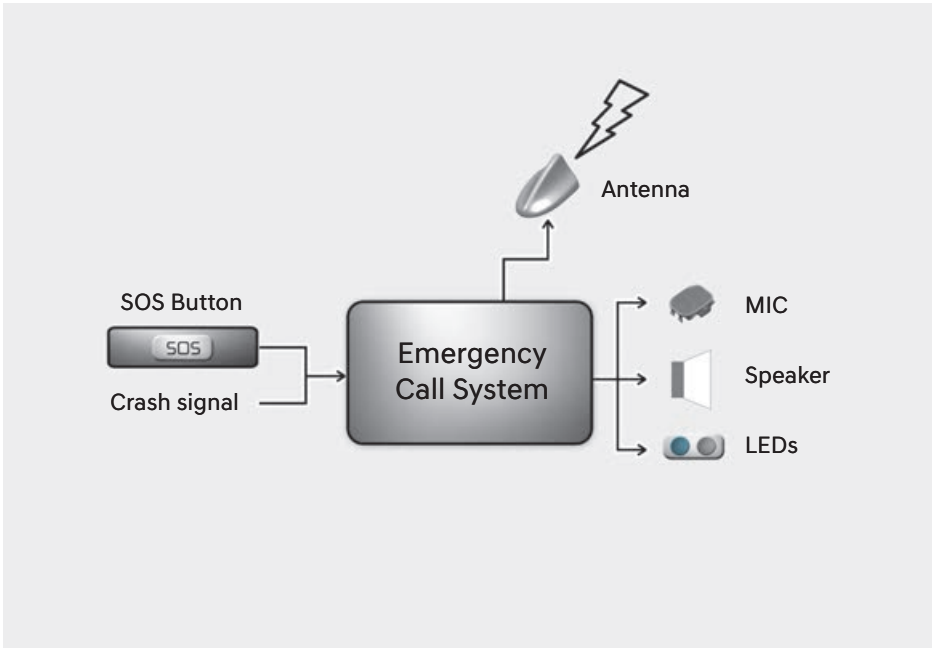

Overview of the 112-based eCall in-vehicle system, its operation and functionalities: refer to this section. The 112-based eCall service is a public service of general interest and is accessible free of charge.

The 112-based eCall in-vehicle system is activated by default. It is activated automatically by means of invehicle sensors in the event of a severe accident.

It will also be triggered automatically when the vehicle is equipped with a TPS system which does not function in the event of a severe accident.

The 112-based eCall in-vehicle system can also be triggered manually, if needed. Instructions for manual activation of the system: refer to this section.

In the event of a critical system failure that would disable the 112-based eCall in-vehicle system, the following warning will be given to the occupants of the vehicle: refer to this section.

Information on data processing

Any processing of personal data through the 112-based eCall in-vehicle system shall comply with the personal data protection rules provided for in Directives 95/46/EC (1) and 2002/58/EC (2) of the European Parliament and of the Council, and in particular, shall be based on the necessity to protect the vital interests of the individuals in accordance with Article 7(d) of Directive 95/46/EC (3).

Processing of such data is strictly limited to the purpose of handling the emergency eCall to the single European emergency number 112.

Types of data and its recipients

The 112-based eCall in-vehicle system may collect and process only the following data:

- Vehicle Identification Number
- Vehicle type (passenger vehicle or light commercial vehicle)
- Vehicle propulsion storage type (gasoline/diesel/CNG/LPG/electric/hydrogen)
- Vehicle recent locations and direction of travel
- Log file of the automatic activation of the system and its time stamp
- Any additional data (if applicable): Not applicable

Recipients of data processed by the 112-based eCall in-vehicle system are the relevant public safety answering points designated by the respective public authorities of the country on which territory they are located, to first receive and handle eCalls to the single European emergency number 112. Additional information (if available): Not applicable

- (1) Directive 95/46/EC of the European Parliament and of the Council of 24 October 1995 on the protection of individuals with regard to the processing of personal data and on the free movement of such data (OJ L 281, 23.11.1995, p. 31).
- (2) Directive 2002/58/EC of the European Parliament and of the Council of 12 July 2002 concerning the processing of personal data and the protection of privacy in the electronic communications sector (Directive on privacy and electronic communications) (OJ L 201, 31.7.2002, p. 37).
- (3) Directive 95/46/EC is repealed by Regulation (EU) 2016/679 of the European Parliament and of the Council of 27 April 2016 on the protection of natural persons with regard to the processing of personal data and on the free movement of such data (General Data Protection Regulation) (OJ L 119, 4.5.2016, p. 1). The Regulation applies from 25 May 2018.

Arrangements for data processing

The 112-based eCall in-vehicle system is designed in such a way as to ensure that the data contained in the system memory is not available outside the system before an eCall is triggered. Additional remarks (if any): Not applicable

The 112-based eCall in-vehicle system is designed in such a way as to ensure that it is not traceable and not subject to any constant tracking in its normal operation status. Additional remarks (if any): Not applicable

The 112-based eCall in-vehicle system is designed in such a way as to ensure that data in the system internal memory is automatically and continuously removed.

The vehicle location data is constantly overwritten in the internal memory of the system so as always to keep maximum of the last three up-to-date locations of the vehicle necessary for the normal functioning of the system.

The log of activity data in the 112-based eCall in-vehicle system is kept for no longer than necessary for attaining the purpose of handling the emergency eCall and in any case not beyond 13 hours from the moment an emergency eCall was initiated. Additional remarks (if any): Not applicable

Modalities for exercising data subject's rights

The data subject (the vehicle's owner) has a right of access to data and as appropriate to request the rectification, erasure or blocking of data, concerning him or her, the processing of which does not comply with the provisions of Directive 95/46/EC. Any third parties to whom the data have been disclosed have to be notified of such rectification, erasure or blocking carried out in compliance with this Directive, unless it proves impossible or involves a disproportionate effort.

The data subject has a right to complain to the competent data protection authority if he or she considers that his or her rights have been infringed as a result of the processing of his or her personal data.

Contact service responsible for handling access requests (if any): Not applicable

Pan-European E-Call system



- (1) SOS button
- (2) LED

Elements of the Pan-European E-Call system, installed in passenger compartment:

SOS button: the driver/passenger makes an emergency call to the single duty dispatch service by pressing the button.

LED: The LED illuminates for 3 seconds when the Engine Start/Stop button is in the ON position. After that they will switch off at normal operation of the system.

If there are some problems in the system, the SOS indicator light illuminates in the instrument cluster.

Automatic accident reporting

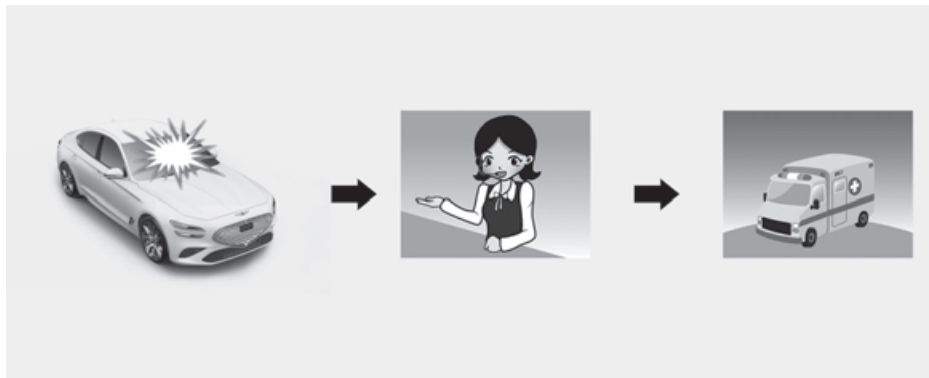

The Pan-European eCall device automatically makes an emergency call to the Public Safety Answering Point (PSAP) for proper rescuing operations in the event of vehicle accident.

For proper emergency services and support, the Pan-European E-Call system automatically transmits the accident data to the Public Safety Answering Point (PSAP) when a traffic accident is detected.

In this case, the emergency call cannot be hung up by pressing the SOS button and the Pan-European E-Call system remains connected until the emergency service officer, receiving the call, disconnects the emergency call.

In minor traffic accidents, the Pan-European E-Call system may not execute an emergency call. However, an emergency call may be made manually by pressing the SOS button.

⚠ CAUTION

Operation of the system is impossible in case of absence of mobile transmission and GPS and Galileo signals.

Manual accident reporting

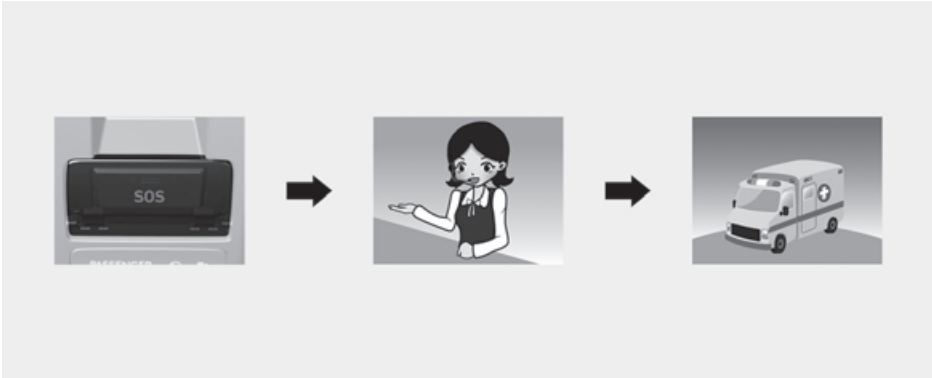

The driver or passenger manually can make an emergency call in the Public Safety Answering Point (PSAP), by pressing SOS button to call the necessary emergency services.

A call to the emergency services through the Pan-European E-Call system can be cancelled by pressing the SOS button again only before the call connection.

After activation of emergency call in the manual mode (for proper emergency services and support), the Pan-European E-Call system automatically transmits the road accident data/or data on other accident to the officer of the Public Safety Answering Point (PSAP) (during emergency call) by pressing the SOS button.

- If the driver or passenger accidentally presses the SOS button, it can be canceled by pressing the button again. (For Russia)
- It can be canceled by pressing the button again in 3 seconds. It can't be canceled after that. (Except Russia)

In case of road accident or other accidents for activation of emergency call in manual mode it is necessary:

1. Stop the vehicle in accordance with traffic rules to ensure safety to yourself and other participants of road traffic;
2. Press the SOS button, when pressing the button SOS registration of the device in the wireless telephonic communication networks is carried out, minimum data set about vehicle and its location is collected in accordance with of the technical requirements of the device. After that connection with the officer of the Pan-European E-Call system is made for clearing up reasons (conditions) of the emergency call.
3. After clearing up reasons of the emergency call, the officer of the Public Safety Answering Point (PSAP) sends emergency services and completes the emergency call.

If the emergency call is not carried out in accordance with the procedure, mentioned above, the emergency call will be considered as erroneous.

⚠ WARNING

Emergency power supply of the Pan-European E-Call system from the battery

- The Pan-European E-Call system battery supplies power during 1 hour in case the main power source of the vehicle is cut off due to the collision during the emergency situations.
- The Pan-European E-Call system battery should be replaced every 4 years. For more information refer to the “Scheduled maintenance services” in chapter 9.

The SOS indicator light in the instrument cluster (system malfunction)

If the SOS indicator light illuminates in normal driving conditions, this can indicate malfunction of the Pan-European E-Call system. We recommend that the Pan-European E-Call system be checked at an authorized retailer of Genesis Branded products immediately. Otherwise correct operation of the Pan-European E-Call system device, installed in your vehicle is not guaranteed. Owner of the vehicle incurs liability for consequences, occurred as a result of nonobservance of conditions, mentioned above.

Arbitrary Removal or Modification

The Pan-European E-Call system calls emergency services for assistance. Thus, any arbitrary removal or changes to the Pan-European E-Call system settings may affect your driving safety. Also, it may even make an erroneous emergency call to the Public Safety Answering Point (PSAP). Thereby, we kindly ask you not to make any changes by yourself or by the third parties in the settings of the equipment of the Pan-European E-Call system, installed in your vehicle.

9. Maintenance

Engine compartment	9-4
Maintenance services	9-7
Owner's responsibility	9-7
Owner maintenance precautions	9-7
Owner maintenance	9-8
Owner maintenance schedule	9-9
Scheduled maintenance services.....	9-10
Normal maintenance schedule (except Europe, but including Russia).....	9-11
Maintenance under severe usage conditions (except Europe, but including Russia)	
.....	9-15
Normal maintenance schedule (for Europe, except Russia)	9-17
Maintenance under severe usage conditions (for Europe, except Russia)	9-22
Explanation of scheduled maintenance items	9-24
Engine oil and filter	9-24
Drive belts.....	9-24
Fuel lines, fuel hoses and connections.....	9-24
Fuel filter (for gasoline engine).....	9-24
Fuel filter (cartridge)(for diesel engine)	9-24
Vapor hose and fuel filler cap	9-24
Vacuum crankcase ventilation hoses (if equipped)	9-24
Air cleaner filter	9-25
Spark plugs (for gasoline engine)	9-25
Cooling system.....	9-25
Engine coolant	9-25
Automatic transmission fluid	9-25
Brake hoses and lines	9-26
Brake fluid.....	9-26
Brake discs, pads, calipers and rotors	9-26
Exhaust pipe and muffler	9-26
Suspension mounting bolts.....	9-26
Steering gear box, linkage & boots/lower arm ball joint.....	9-26
Drive shafts and boots.....	9-26
Air conditioning refrigerant.....	9-26
Engine oil.....	9-27
Checking the engine oil level	9-27
Checking the engine oil and filter.....	9-30

Engine coolant	9-31
Checking the coolant level	9-31
Changing coolant	9-33
Brake fluid.....	9-34
Checking the brake fluid level	9-34
Washer fluid.....	9-35
Checking the washer fluid level	9-35
Fuel filter (for diesel engine)	9-36
Draining water from fuel filter	9-36
Fuel filter cartridge replacement	9-36
Air cleaner.....	9-37
Filter replacement	9-37
Cabin air filter	9-38
Filter inspection	9-38
Filter replacement	9-38
Wiper blades.....	9-39
Blade inspection	9-39
Blade replacement	9-39
Battery	9-41
For best battery service	9-42
Battery Replacement	9-43
Battery capacity label	9-44
Battery recharging	9-44
Reset items	9-45
Tires and wheels.....	9-46
Tire care	9-46
Recommended cold tire inflation pressures	9-46
Check tire inflation pressure.....	9-47
Tire rotation	9-48
Wheel alignment and tire balance	9-49
Tire replacement	9-49
Wheel replacement	9-50
Tire traction.....	9-50
Tire maintenance.....	9-50
Tire sidewall labeling.....	9-51

9. Maintenance

Low aspect ratio tires	9-54
Fuses.....	9-55
Instrument panel fuse replacement	9-56
Engine compartment panel fuse replacement.....	9-57
Fuse/relay panel description.....	9-58
Light bulbs.....	9-76
Headlight, Position light, Turn signal light, Daytime running light (DRL) replacement	9-77
Headlight aiming.....	9-78
Side repeater light replacement	9-81
Puddle light replacement	9-81
Rear combination light replacement.....	9-82
Rear fog light replacement	9-82
High mounted stop light replacement.....	9-83
License plate light replacement	9-83
Interior light replacement	9-84
Appearance care.....	9-85
Exterior care	9-85
Interior care.....	9-91
Emission control system	9-94
Crankcase emission control system.....	9-95
Evaporative emission control system.....	9-95
Exhaust emission control system	9-95
Gasoline Particulate Filter (GPF).....	9-96
Diesel Particulate Filter (DPF)	9-97
Lean NOx Trap (for diesel engine)	9-98
Selective Catalytic Reduction (SCR) (for diesel engine).....	9-98

Engine compartment

2.0L T-GDI

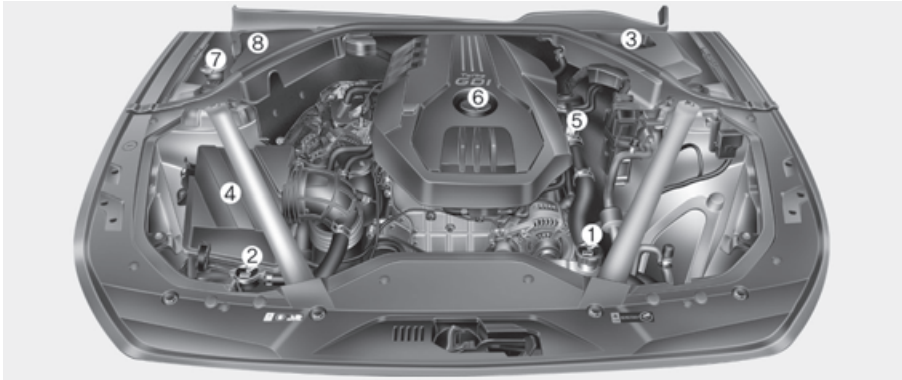

The actual engine compartment in the vehicle may differ from the illustration.

- (1) Engine coolant reservoir
 - (2) Radiator cap
 - (3) Brake fluid reservoir
 - (4) Air cleaner
 - (5) Engine oil dipstick
 - (6) Engine oil filler cap
 - (7) Windshield washer fluid reservoir
 - (8) Fuse box
- * Battery is in the trunk (or tailgate)

3.3L T-GDI

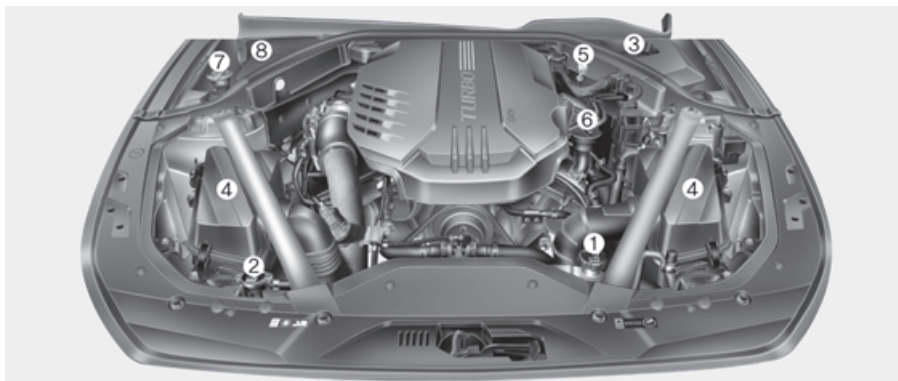

The actual engine compartment in the vehicle may differ from the illustration.

- (1) Engine coolant reservoir
 - (2) Radiator cap
 - (3) Brake fluid reservoir
 - (4) Air cleaner
 - (5) Engine oil dipstick
 - (6) Engine oil filler cap
 - (7) Windshield washer fluid reservoir
 - (8) Fuse box
- * Battery is in the trunk (or tailgate)

2.2L TCI

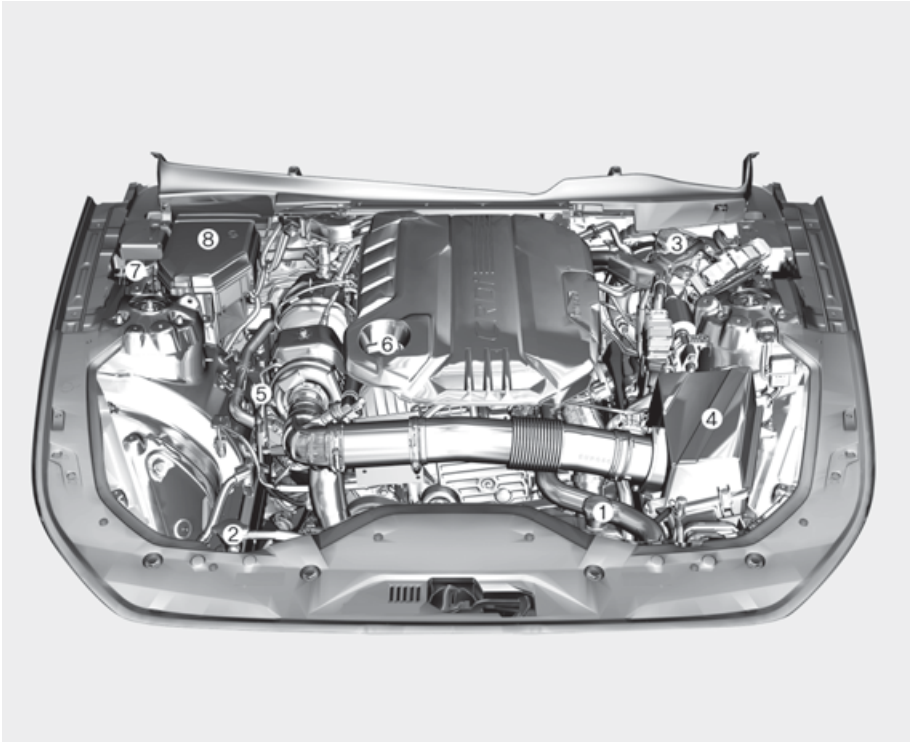

The actual engine compartment in the vehicle may differ from the illustration.

- (1) Engine coolant reservoir
- (2) Radiator cap
- (3) Brake fluid reservoir
- (4) Air cleaner
- (5) Engine oil dipstick
- (6) Engine oil filler cap
- (7) Windshield washer fluid reservoir
- (8) Fuse box

*Battery is in the trunk (or tailgate)

Maintenance services

You should exercise the utmost care to prevent damage to your vehicle and injury to yourself whenever performing any maintenance or inspection procedures.

We recommend you have your vehicle maintained and repaired by an authorized retailer of Genesis Branded products. An authorized retailer of Genesis Branded products meets Genesis Branded Vehicle's high service quality standards and receives technical support from Genesis Branded Vehicle in order to provide you with a high level of service satisfaction.

Owner's responsibility

Maintenance service and record retention are the owner's responsibility.

You should retain documents that show proper maintenance has been performed on your vehicle in accordance with the scheduled maintenance service charts shown on the following pages. You need this information to establish your compliance with the servicing and maintenance requirements of your vehicle warranties.

Detailed warranty information is provided in your Service Passport.

Repairs and adjustments required as a result of improper maintenance or a lack of required maintenance are not covered.

Owner maintenance precautions

Inadequate, incomplete or insufficient servicing may result in operational problems with your vehicle that could lead to vehicle damage, an accident, or personal injury. This chapter provides instructions only for the maintenance items that are easy to perform.

Your vehicle should not be modified in any way. Such modifications may adversely affect the performance, safety or durability of your vehicle and may, in addition, violate conditions of the limited warranties covering the vehicle.

NOTICE

Improper owner maintenance during the warranty period may affect warranty coverage. For details, read the separate Service Passport provided with the vehicle. If you're unsure about any service or maintenance procedure, have it done by an authorized retailer of Genesis Branded products.

Owner maintenance

WARNING

Performing maintenance work on a vehicle can be dangerous. If you lack sufficient knowledge and experience or the proper tools and equipment to do the work, have it done by an authorized retailer of Genesis Branded products. Always follow these precautions for performing maintenance work:

- Park your vehicle on level ground. Shift the vehicle to P (Park), apply the parking brake, and press the Engine Start/Stop button to the OFF position.
 - Block the tires (front and back) to prevent the vehicle from moving. Remove loose clothing or jewelry that can become entangled in moving parts.
 - If you must run the engine during maintenance, do so in an outdoor area or in an area with plenty of ventilation.
 - Keep flames, sparks, or smoking materials away from the battery and fuel-related parts.
-

WARNING

Touching metal parts



Do not touch metal parts (including strut bars) while the engine is operating or hot. Doing so could result in serious personal injury. Turn the engine off and wait until the metal parts cool down to perform maintenance work on the vehicle.

The following lists are vehicle checks and inspections that should be performed by the owner or an authorized retailer of Genesis Branded products at the frequencies indicated to help ensure safe, dependable operation of your vehicle.

Any adverse conditions should be brought to the attention of your dealer as soon as possible.

These Owner Maintenance vehicle checks are generally not covered by warranties and you may be charged for labor, parts and lubricants used.

WARNING

Diesel Engine

Never manipulate or modify the injection system while running the diesel engine or within 30 seconds after turning OFF the diesel engine. The high-pressure pump, high-pressure pipes, rail, and injectors are still subject to high pressure immediately after stopping the diesel engine.

When the fuel leakage vents out, it may cause serious body injury. Any people, who are implanted with the artificial cardiac pacemaker, should remain away from the ECU or the wiring harness by at least 30 cm (12 in.), while running the diesel engine. The high currents of the electronic engine control system produce a considerable amount of magnetic fields.

Owner maintenance schedule

When you stop for fuel:

- Check the coolant level in the engine coolant reservoir.
- Check the windshield washer fluid level.
- Check for low or under-inflated tires.

WARNING

Be careful when checking your coolant level when the engine is hot. This may result in coolant being blown out of the opening and cause serious burns and other injuries.

While operating your vehicle:

- Note any changes in the sound of the exhaust or any smell of exhaust fumes in the vehicle.
- Check for vibrations in the steering wheel. Notice if there is any increased steering effort or looseness in the steering wheel, or change in its straight-ahead position.
- Notice if your vehicle constantly turns slightly or “pulls” to one side when traveling on smooth, level road.
- When stopping, listen and check for unusual sounds, pulling to one side, increased brake pedal travel or “hard-to-push” brake pedal.
- If any slipping or changes in the operation of your transmission occurs, check the transmission fluid level.
- Check the automatic transmission P (Park) function.
- Check the parking brake.
- Check for fluid leaks under your vehicle (water dripping from the air conditioning system during or after use is normal).

At least monthly:

- Check coolant level in the engine coolant reservoir.
- Check the operation of all exterior lights, including the stoplights, turn signals and hazard warning flashers.
- Check the inflation pressures of all tires including the spare for tires that are worn, show uneven wear, or are damaged.
- Check for loose wheel lug nuts.

At least twice a year: (for example, every Spring and Autumn)

- Check radiator, heater and air conditioning hoses for leaks or damage.
- Check windshield washer spray and wiper operation. Clean wiper blades with a clean cloth dampened with washer fluid.
- Check headlight alignment.
- Check muffler, exhaust pipes, shields and clamps.
- Check the seat belts for wear and function.

At least once a year:

- Clean body and door drain holes.
- Lubricate door hinges and hood hinges.
- Lubricate door and hood locks and latches.
- Lubricate door rubber weather strips.
- Check the air conditioning system.
- Inspect and lubricate automatic transmission linkage and controls.
- Clean the battery and terminals.
- Check the brake fluid level.

Scheduled maintenance services

Follow Normal Maintenance Schedule if the vehicle is usually operated where none of the following conditions apply. If any of the following conditions apply, you must follow the Maintenance Under Severe Usage Conditions.

- Repeated driving short distance of less than 8 km (5 miles) in normal temperature or less than 16 km (10miles) in freezing temperature
- Extensive engine idling or low speed driving for long distances
- Driving on rough, dusty, muddy, unpaved, graveled or salt-spread roads
- Driving in areas using salt or other corrosive materials or in very cold weather
- Driving in heavy dust conditions
- Driving in heavy traffic area
- Driving on uphill, downhill, or mountain road repeatedly
- Using for towing or camping, and driving with loads on the roof
- Driving as a patrol car, taxi, other commercial use of vehicle towing
- Frequently driving under high speed or rapid acceleration/deceleration
- Frequently driving in stop-and-go condition
- Engine oil usage which is not recommended (Mineral type, Semi-synthetic, Lower grade spec, etc.)

If your vehicle is operated under the above conditions, you should inspect, replace or refill more frequently than the following Normal Maintenance Schedule. After the periods or distance shown in the chart, continue to follow the prescribed maintenance intervals.

i Information

- As it is normal for engine oil to be consumed during driving, the engine oil level should be checked on regular basis.
 - The engine oil change interval for normal operating conditions is based on the use of the recommended engine specification. If the recommended engine oil specification is not used, then replace the engine oil according to the maintenance schedule under severe operating conditions.
-

Normal maintenance schedule (except Europe, but including Russia)

I : Inspect and if necessary, adjust, correct, clean or replace.

R : Replace or change.

MAINTENANCE INTERVALS	Number of months or driving distance, whichever comes first									
	Months	12	24	36	48	60	72	84	96	
	Miles×1,000	10	20	30	40	50	60	70	80	
	Km×1,000	15	30	45	60	75	90	105	120	
MAINTENANCE ITEM										
Engine oil and engine oil filter ^{*1*2*5}		Replace every 10,000 km (6,500 miles) or 12 months								
Drive belts ^{*3}		I			I		I		I	
Fuel additives ^{*4}		Add every 10,000 km (6,500 miles)								
Intercooler, in/out hose, air intake hose		At first, Inspect at 10,000km (6,500 miles) or 6 months After that, Inspect every 30,000 km (20,000 miles) or 24 months								

*1 The engine oil level should be checked regularly and maintained properly. Operating with an insufficient amount of oil can damage the engine, and such damage is not covered by warranty.

*2 Check the engine oil level and leak every 500 km (350 miles) or before starting a long trip.

*3 Inspect drive belt tensioner, idler and alternator pulley and if necessary correct or replace.

*4 If good quality gasolines meet Europe Fuel standards (EN228) or equivalents including fuel additives is not available, one bottle of additive is recommended. Additives are available from your an authorized retailer of Genesis Branded products along with information on how to use them. Do not mix other additives.

*5 Never add any additives to the engine oil. Engine oil additives can change the properties of engine oil and may cause serious engine failure.

I : Inspect and if necessary, adjust, correct, clean or replace.

R : Replace or change.

MAINTENANCE INTERVALS	Number of months or driving distance, whichever comes first								
	Months	12	24	36	48	60	72	84	96
	Miles×1,000	10	20	30	40	50	60	70	80
	Km×1,000	15	30	45	60	75	90	105	120
MAINTENANCE ITEM									
Air cleaner filter	Except Middle East	I	I	R	I	I	R	I	I
	For Middle East	R	R	R	R	R	R	R	R
Valve clearance ^{*1*2}		Inspect every 90,000 km (60,000 miles) or 72 months							
Spark plugs ^{*1}		Replace every 70,000 km (45,500 miles)							
Vapor hose and fuel filler cap					I				I
Vacuum hose and crankcase ventilation hoses		I	I	I	I	I	I	I	I
Fuel tank air filter			I		R		I		R
Fuel lines, hoses and connections					I				I

*1 For your convenience, it can be replaced prior to it's interval when you do maintenance of other items.

*2 Inspect for excessive valve noise and/or engine vibration and adjust if necessary. We recommend that the system be checked by an authorized retailer of Genesis Branded products.

i Information

The fuel filter is considered to be maintenance free but the quality of fuel used may impact the frequency of maintenance needed. If there are some important safety matters like fuel flow restriction, surging, loss of power, hard starting problem, etc. replace the fuel filter immediately regardless of maintenance schedule and consult an authorized retailer of Genesis Branded products for details.

I : Inspect and if necessary, adjust, correct, clean or replace.

R : Replace or change.

MAINTENANCE INTERVALS	Number of months or driving distance, whichever comes first									
	Months	12	24	36	48	60	72	84	96	
	Miles×1,000	10	20	30	40	50	60	70	80	
	Km×1,000	15	30	45	60	75	90	105	120	
MAINTENANCE ITEM										
Cooling system		I	I	I	I	I	I	I	I	
Engine coolant *1		At first, replace at 195,000 km (120,000 miles) or 120 months : after that, replace every 30,000 km (25,000 miles) or 24 months								
Battery condition	Except Middle East	I	I	I	I	I	I	I	I	
	For Middle East	Inspect every 10,000 km (6,500 miles) or 6 months								
All electrical system		I	I	I	I	I	I	I	I	
Pan-European eCall system battery/ERA-GLONASS system battery		Replace every 4 years								
Brake lines, hoses and connections		I	I	I	I	I	I	I	I	
Brake pedal			I		I		I		I	
Parking brake			I		I		I		I	
Brake fluid		I	I	R	I	I	R	I	I	

*1 When adding coolant, use only deionized water or soft water for your vehicle and never mix hard water in the coolant filled at the factory. An improper coolant mixture can result in serious malfunction or engine damage. For your convenience, it can be replaced prior to it's interval when you do maintenance of other items.

Maintenance

I : Inspect and if necessary, adjust, correct, clean or replace.

R : Replace or change.

MAINTENANCE INTERVALS	Number of months or driving distance, whichever comes first									
	Months	12	24	36	48	60	72	84	96	
	Miles×1,000	10	20	30	40	50	60	70	80	
	Km×1,000	15	30	45	60	75	90	105	120	
MAINTENANCE ITEM										
Disc brakes and pads		I	I	I	I	I	I	I	I	
Steering gear rack, linkage and boots		I	I	I	I	I	I	I	I	
Driveshaft and boots			I		I		I		I	
Tire (pressure & tread wear)		I	I	I	I	I	I	I	I	
Front suspension ball joints		I	I	I	I	I	I	I	I	
Air conditioner refrigerant		I	I	I	I	I	I	I	I	
Air conditioner compressor		I	I	I	I	I	I	I	I	
Cabin air filter		R	R	R	R	R	R	R	R	
Automatic transmission fluid		No check, No service required								
Exhaust system			I		I		I		I	
Front differential oil (AWD) ^{*1}					I				I	
Rear differential oil ^{*1*2}	Without LSD				I				I	
	With LSD				R				R	
Propeller shaft			I		I		I		I	
Transfer case oil (AWD)		No check, No service required								

*1 Front/Rear differential oil should be changed anytime they have been submerged in water.

*2 When replacing differential oil with LSD (Limited Slip Differential), use only specified LSD oil.

Maintenance under severe usage conditions (except Europe, but including Russia)

The following items must be serviced more frequently on cars mainly used under severe driving conditions. Refer to the chart below for the appropriate maintenance intervals.

R : Replace

I : Inspect and if necessary, adjust, correct, clean or replace

Maintenance item		Maintenance operation	Maintenance intervals	Driving condition
Engine oil and engine oil filter		R	Replace every 5,000 km (3,000 miles) or 6 months	A, B, C, D, E, F, G, H, I, J, K, L
Air cleaner filter		R	Replace more frequently depending on the condition	C, E
Spark plugs		R	Replace more frequently depending on the condition	A, B, F, G, H, I, K
Steering gear rack, linkage and boots		I	Inspect more frequently depending on the condition	C, D, E, F, G
Front suspension ball joints		I	Inspect more frequently depending on the condition	C, D, E, F, G
Disc brakes and pads, calipers and rotors		I	Inspect more frequently depending on the condition	C, D, E, G, H
Parking brake		I	Inspect more frequently depending on the condition	C, D, G, H
Driveshaft and boots		I	Inspect more frequently depending on the condition	C, D, E, F, G, H, I, J
Cabin air filter		R	Replace more frequently depending on the condition	C, E, G
Automatic transmission fluid		R	Replace every 100,000 km (60,000 miles)	A, C, F, G, H, I, K
Front differential oil (AWD)		R	Replace every 120,000 km (80,000 miles)	C, E, G, H, I, J
Rear differential oil	Without LSD	R	Replace every 120,000 km (80,000 miles)	C, E, G, H, I, J
	With LSD		Replace every 60,000 km (40,000 miles)	
Propeller shaft		I	Inspect more frequently depending on the condition	C, D, E, F, G, H, I, J

Maintenance item	Maintenance operation	Maintenance intervals	Driving condition
Transfer case oil (AWD)		No check, No service required	

Severe driving conditions

- A. Repeatedly driving short distance of less than 8 km (5 miles) in normal temperature or less than 16 km (10 miles) in freezing temperature
- B. Extensive engine idling or low speed driving for long distances
- C. Driving on rough, dusty, muddy, unpaved, graveled or saltspread roads
- D. Driving in areas using salt or other corrosive materials or in very cold weather
- E. Driving in the condition of inflowing sand or dust into engine
- F. Driving in heavy traffic area
- G. Driving on uphill, downhill, or mountain roads
- H. Using for towing or camping, and driving with loads on the roof
- I. Driving for patrol car, taxi, other commercial use of vehicle towing
- J. Frequently driving under high speed or rapid acceleration/deceleration
- K. Frequently driving in stop-and-go conditions
- L. Engine oil usage which is not recommended (Mineral type, Semi-synthetic, Lower grade spec, etc.)

Normal maintenance schedule (for Europe, except Russia)

Gasoline engine items

I : Inspect and if necessary, adjust, correct, clean or replace.

R : Replace or change.

MAINTENANCE INTERVALS	Number of months or driving distance, whichever comes first								
	Months	24	48	72	96	120	144	168	192
	Miles× 1,000	20	40	60	80	100	120	140	160
	Km× 1,000	30	60	90	120	150	180	210	240
MAINTENANCE ITEM									
Engine oil and engine oil filter ^{*1*2*3}	Replace every 10,000 km (6,500 miles) or 12 months								
Drive belts *4	At first, inspect at 90,000 km (60,000 miles) or 72 months, after that, every 30,000 km (20,000 miles) or 24 months								
Fuel additives *5	Replace every 10,000 km (6,500 miles) or 12 months								
Valve clearance*6*7			I				I		
Air cleaner filter	I	R	I	R	I	R	I	R	
Spark plugs *6	Replace every 80,000 km (53,000 miles)								
Vacuum hose and crankcase ventilation hoses	I	I	I	I	I	I	I	I	I
Vapor hose and fuel filler cap		I		I		I		I	
Fuel tank air filter		I		I		I		I	
Fuel lines, hoses and connections		I		I		I		I	

*1 The engine oil level should be checked regularly and maintained properly. Operating with an insufficient amount of oil can damage the engine, and such damage is not covered by warranty.

*2 Check the engine oil level and leak every 500 km (350 miles) or before starting a long trip.

*3 Never add any additives to the engine oil. Engine oil additives can change the properties of engine oil and may cause serious engine failure.

*4 Inspect drive belt tensioner, idler and alternator pulley and if necessary correct or replace.

*5 If good quality gasolines meet Europe Fuel standards (EN228) or equivalents including fuel additives is not available, one bottle of additive is recommended. Additives are available from your authorized retailer of Genesis Branded products along with information on how to use them. Do not mix other additives.

*6 For your convenience, it can be replaced prior to it's interval when you do maintenance of other items.

*7 Inspect for excessive valve noise and/or engine vibration and adjust if necessary. We recommend that the system be checked by an authorized retailer of Genesis Branded products.

i Information

The fuel filter is considered to be maintenance free but periodic inspection is recommended for this maintenance schedule depending on fuel quality. If there are some important safety matters like fuel flow restriction, surging, loss of power, hard starting problem etc, replace the fuel filter immediately regardless of maintenance schedule and consult an authorized retailer of Genesis Branded products for details.

Diesel engine items

I : Inspect and if necessary, adjust, correct, clean or replace.

R : Replace or change.

MAINTENANCE INTERVALS	Number of months or driving distance, whichever comes first									
	Months	24	48	72	96	120	144	168	192	
	Miles× 1,000	20	40	60	80	100	120	140	160	
	Km× 1,000	30	60	90	120	150	180	210	240	
MAINTENANCE ITEM										
Engine oil and engine oil filter *1*2*3 *4*5	2WD	Replace every 20,000 km (13,000 miles) or 12 months								
	AWD	R	R	R	R	R	R	R	R	R
Drive belts *6	At first, inspect at 90,000 km (60,000 miles) or 48 months, after that, every 30,000 km (20,000 miles) or 24 months									
Timing belt system (Timing belt, Water pump, Tensioner, Idler)	Inspect Timing belt every 120,000km (80,000miles) Replace Timing belt system(Timing belt, Water pump, Tensioner, Idler) every 240,000km (160,000miles)									
Air cleaner filter	I	R	I	R	I	R	I	R	I	
Fuel lines, hoses and connections	I	I	I	I	I	I	I	I	I	
Fuel filter cartridge *7	I	R	I	R	I	R	I	R	I	
Fuel filler cap		I		I		I		I		

*1 The engine oil level should be checked regularly and maintained properly. Operating with an insufficient amount of oil can damage the engine, and such damage is not covered by warranty.

*2 Check the engine oil level and leak every 500 km (350 miles) or before starting a long trip.

*3 This maintenance schedule depends on fuel quality. It is applicable only when using a qualified fuel <"EN590 or equivalent">. If the diesel fuel specifications don't meet the EN590, it must be replaced according to the severe maintenance schedule.

*4 If the recommended oil is not available, replace engine oil and engine oil filter every 20,000 km or 12 months.

*5 Never add any additives to the engine oil. Engine oil additives can change the properties of engine oil and may cause serious engine failure.

*6 Inspect drive belt tensioner, idler and alternator pulley and if necessary correct or replace.

*7 This maintenance schedule depends on fuel quality. It is applicable only when using a qualified fuel <"EN590 or equivalent">. If the diesel fuel specifications don't meet the EN590, it must be replaced more frequently. If there are some important safety matters like fuel flow restriction, surging, loss of power, hard starting problem etc., replace the fuel filter immediately regardless of maintenance schedule. We recommend that you consult an authorized retailer of Genesis Branded products for details.

General items - for both Gasoline and Diesel engine

I : Inspect and if necessary, adjust, correct, clean or replace.

R : Replace or change.

MAINTENANCE INTERVALS	Number of months or driving distance, whichever comes first									
	Months	24	48	72	96	120	144	168	192	
	Miles× 1,000	20	40	60	80	100	120	140	160	
	Km× 1,000	30	60	90	120	150	180	210	240	
MAINTENANCE ITEM										
Cooling system		I	I	I	I	I	I	I	I	
Engine coolant *1		At first, replace at 180,000 km (120,000 miles) or 10 years : after that, replace every 30,000 km (20,000 miles) or 24 months *2								
All electrical system		I	I	I	I	I	I	I	I	
Battery condition		I	I	I	I	I	I	I	I	
Pan-European eCall system battery		Replace every 4 years								
Brake lines, hoses and connections		I	I	I	I	I	I	I	I	
Parking brake		I	I	I	I	I	I	I	I	
Brake fluid		R	R	R	R	R	R	R	R	
Disc brakes and pads		I	I	I	I	I	I	I	I	

*1 : When adding coolant, use only deionized water or soft water for your vehicle and never mix hard water in the coolant filled at the factory. An improper coolant mixture can result in serious malfunction or engine damage.

*2 : For your convenience, it can be replaced prior to it's interval when you do maintenance of other items.

General items - for both Gasoline and Diesel engine

I : Inspect and if necessary, adjust, correct, clean or replace.

R : Replace or change.

MAINTENANCE INTERVALS	Number of months or driving distance, whichever comes first								
	Months	24	48	72	96	120	144	168	192
	Miles× 1,000	20	40	60	80	100	120	140	160
	Km× 1,000	30	60	90	120	150	180	210	240
MAINTENANCE ITEM									
Steering gear rack, linkage and boots									
Driveshaft and boots									
Tire (pressure & tread wear)									
Front suspension ball joints									
Air conditioner refrigerant									
Air conditioner compressor									
Cabin air filter									
Automatic transmission fluid									
Exhaust system									
Front differential oil (AWD) *1									
Rear differential oil *1*2									
Propeller shaft									
Transfer case oil (AWD)									

*1 : Front/Rear differential oil should be changed anytime they have been submerged in water.

*2 : When replacing differential oil with LSD (Limited Slip Differential), use only specified LSD oil.

Maintenance under severe usage conditions (for Europe, except Russia)

The following items must be serviced more frequently on cars mainly used under severe and low mileage driving conditions. Refer to the chart below for the appropriate maintenance intervals.

R : Replace

I : Inspect and if necessary, adjust, correct, clean or replace

Maintenance item		Maintenance operation	Maintenance Intervals	Driving condition
Engine oil and engine oil filter	Gasoline engine	R	Replace every 5,000 km (3,000 miles) or 6 months	A, B, C, D, E, F, G, H, I, J, K, L
	Diesel engine	R	Replace every 15,000 km (10,000 miles) or 12 months	
	Diesel engine (2WD)	R	Replace every 10,000 km (6,500 miles) or 6 months	
Air cleaner filter		R	Replace more frequently depending on the condition	C, E
Spark plugs		R	Replace more frequently depending on the condition	A, B, F, H, I, K
Steering gear rack, linkage and boots		I	Inspect more frequently depending on the condition	C, D, E, F, G
Front suspension ball joints		I	Inspect more frequently depending on the condition	C, D, E, F, G
Disc brakes and pads, calipers and rotors		I	Inspect more frequently depending on the condition	C, D, E, G, H
Parking brake		I	Inspect more frequently depending on the condition	C, D, G, H
Driveshaft and boots		I	Inspect more frequently depending on the condition	C, D, E, F, G, H, I, J
Cabin air filter		R	Replace more frequently depending on the condition	C, E, G
Automatic transmission fluid		R	Replace every 90,000 km (56,000 miles)	A, C, F, G, H, I, K
Front differential oil (AWD)/Rear differential oil		R	Replace every 120,000 km (80,000 miles)	C, D, E, G, H, I, J

Maintenance item		Maintenance operation	Maintenance Intervals	Driving condition
Rear differential oil	Without LSD	R	Replace every 120,000 km (80,000 miles)	C, D, E, G, H, I, J
	With LSD		Replace every 60,000 km (40,000 miles)	
Propeller shaft		I	Inspect more frequently depending on the condition	C, D, E, F, G, H, I, J
Transfer case oil (AWD)		No check, No service required		

Severe driving conditions

- A. Repeatedly driving short distance of less than 8 km (5 miles) in normal temperature or less than 16 km (10 miles) in freezing temperature
- B. Extensive engine idling or low speed driving for long distances
- C. Driving on rough, dusty, muddy, unpaved, graveled or salt spread roads
- D. Driving in areas using salt or other corrosive materials or in very cold weather
- E. Driving in the heavy dust condition
- F. Driving in heavy traffic area
- G. Driving on uphill, downhill, or mountain roads repeatedly
- H. Using for towing or camping, and driving with loads on the roof
- I. Driving for patrol car, taxi, other commercial use of vehicle towing
- J. Frequently driving under high speed or rapid acceleration/deceleration
- K. Frequently driving in stop-and-go conditions and under 15,000 km per year.
- L. Engine oil usage which is not recommended (Mineral type, Semi-synthetic, Lower grade spec, etc.)

Explanation of scheduled maintenance items

Engine oil and filter

The engine oil and filter should be changed at the intervals specified in the maintenance schedule. If the vehicle is being driven in severe conditions, more frequent oil and filter changes are required.

Drive belts

Inspect all drive belts for evidence of cuts, cracks, excessive wear or oil saturation and replace if necessary.

Drive belts should be checked periodically for proper tension and adjusted as necessary.

i Information

When you are inspecting the belt, turn the engine off.

Fuel lines, fuel hoses and connections

Check the fuel lines, fuel hoses and connections for leakage and damage. We recommend an authorized retailer of Genesis Branded products replace any damaged or leaking parts immediately.

Fuel filter (for gasoline engine)

The fuel filter is considered to be maintenance free but periodic inspection is recommended for this maintenance depends on fuel quality. If there are some important matters like fuel flow restriction, surging, loss of power, hard starting problem etc., replace the fuel filter immediately. We recommend that you consult an authorized retailer of Genesis Branded products for details.

Fuel filter (cartridge)(for diesel engine)

A clogged filter can limit the speed at which the vehicle may be driven, damage the emission system and cause multiple issues such as hard starting. If an excessive amount of foreign matter accumulates in the fuel tank, the filter may require replacement more frequently. After installing a new filter, run the engine for several minutes, and check for leaks at the connections. We recommend that the fuel filter be installed by an authorized retailer of Genesis Branded products.

Vapor hose and fuel filler cap

The vapor hose and fuel filler cap should be inspected at those intervals specified in the maintenance schedule. Make sure a new vapor hose or fuel filler cap is correctly replaced.

Vacuum crankcase ventilation hoses (if equipped)

Inspect the surface of hoses for evidence of heat and/or mechanical damage. Hard and brittle rubber, cracking, tears, cuts, abrasions, and excessive swelling indicate deterioration. Particular attention should be paid to examine those hose surfaces nearest to high heat sources, such as the exhaust manifold.

Inspect the hose routing to ensure that the hoses do not come in contact with any heat source, sharp edges or moving component which might cause heat damage or mechanical wear. Inspect all hose connections, such as clamps and couplings, to make sure they are secure, and that no leaks are present. Hoses should be replaced immediately if there is any evidence of deterioration or damage.

Air cleaner filter

We recommend that the air cleaner filter be replaced by an authorized retailer of Genesis Branded products.

Spark plugs (for gasoline engine)

Make sure to install new spark plugs of the correct heat range.

When assembling parts, be sure to wipe out foreign substances inside and outside of the boot bottom of the ignition coil and the insulator of the spark plug with a soft cloth to prevent contamination of the spark plug insulator.

Cooling system

Check cooling system components, such as radiator, coolant reservoir, hoses and connections for leakage and damage. Replace any damaged parts.

Engine coolant

The coolant should be changed at the intervals specified in the maintenance schedule.

Automatic transmission fluid

Automatic transmission fluid should not be checked under normal usage conditions.

We recommend that the automatic transmission fluid be changed by an authorized retailer of Genesis Branded products according to the maintenance schedule.

i Information

Automatic transmission fluid color is red when new.

As the vehicle is driven, the automatic transmission fluid will begin to look darker.

This is a normal condition. It does not need to be replaced based on the color change.

NOTICE

The use of a non-specified fluid could result in transmission malfunction and failure.

Use only specified automatic transmission fluid. (Refer to the "Recommended lubricants and capacities" section in chapter 2.)

Brake hoses and lines

Visually check for proper installation, chafing, cracks, deterioration and any leakage. Replace any deteriorated or damaged parts immediately.

Brake fluid

Check the brake fluid level in the brake fluid reservoir. The level should be between the MIN and the MAX marks on the side of the reservoir. Use only hydraulic brake fluid conforming to DOT 4 specification.

Brake discs, pads, calipers and rotors

Check the pads, the disc, and the rotor for any excessive wear-out. Inspect calipers for any fluid leakage.

For more information on checking the pads or lining wear limit, refer to the Genesis Branded Vehicle web site.

(<http://service.hyundai-motor.com>)

Exhaust pipe and muffler

Visually inspect the exhaust pipes, muffler and hangers for cracks, deterioration, or damage. Start the engine and listen carefully for any exhaust gas leakage. Tighten connections or replace parts as necessary.

Suspension mounting bolts

Check the suspension connections for looseness or damage. Retighten to the specified torque.

Steering gear box, linkage & boots/lower arm ball joint

With the vehicle stopped and the engine off, check for excessive free-play in the steering wheel. Check the linkage for bends or damage. Check the dust boots and ball joints for deterioration, cracks, or damage.

Replace any damaged parts.

Drive shafts and boots

Check the drive shafts, boots and clamps for cracks, deterioration, or damage. Replace any damaged parts and, if necessary, repack the grease.

Air conditioning refrigerant

Check the air conditioning lines and connections for leakage and damage.

Engine oil

Checking the engine oil level

Engine oil is used for lubricating, cooling, and operating various hydraulic components in the engine. Engine oil consumption while driving is normal, and it is necessary to check and refill the engine oil regularly. Also, check and refill the oil level within the recommended maintenance schedule to prevent deterioration of oil performance.

Check the engine oil following the below procedure.

Gasoline engine

1. Follow all of the oil manufacturer's precautions.
2. Be sure the vehicle is on the level ground in P (Park) with the parking brake set and the wheels blocked.
3. Turn the engine on and warm the engine up until the coolant temperature reaches a constant normal temperature.
4. Turn the engine off, remove the oil filler cap and pull the dipstick out. Wait for 15 minutes for the oil to return to the oil pan.
5. Wipe the dipstick clean and re-insert it fully.
6. Pull the dipstick out again and check the level. The level should be between F (Full) and L (Low).

2.0L T-GDI

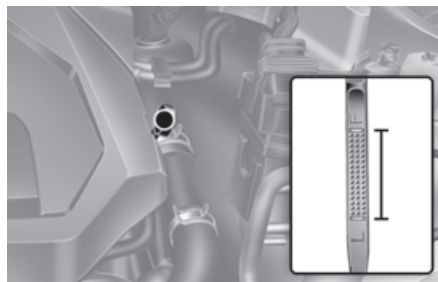

3.3L T-GDI

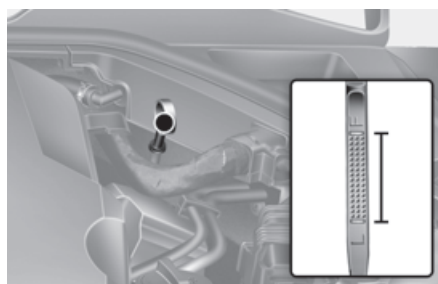

7. If the oil level is below L, add enough oil to bring the level to F.

2.0L T-GDI

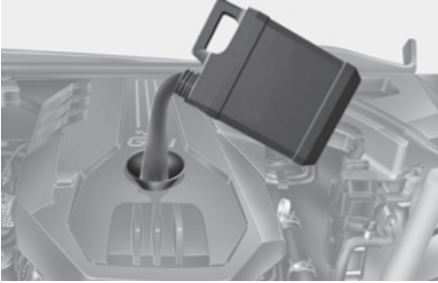

3.3L T-GDI

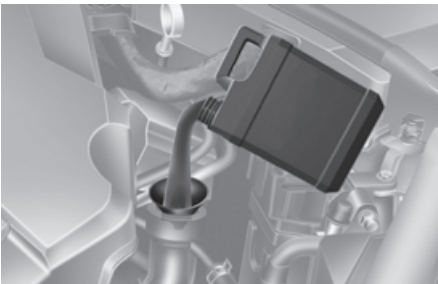

Use only the specified engine oil (Refer to the “Recommended lubricants and capacities” section in chapter 2).

NOTICE

To prevent damage to your engine:

- Do not spill engine oil when adding or changing engine oil. Wipe off spilled oil immediately.
- The engine oil consumption may increase while you break in a new vehicle and it will be stabilized after driving 6,000 km (4,000 miles).
- The engine oil consumption can be affected by driving habits, climate conditions, traffic conditions, oil quality, etc. Therefore, it is recommended that you inspect the engine oil level regularly and refill it if necessary.

Diesel engine

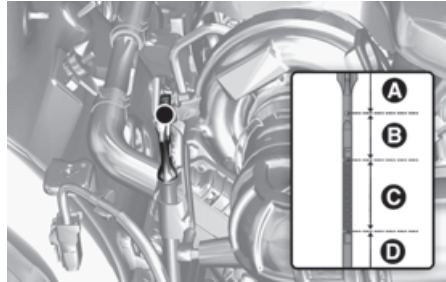

Range	Required action
A	Recommended to contact an authorized retailer of Genesis Branded products.
B	Do not refill engine oil.
C	You may add engine oil as long as the oil level does not go above the C range.
D	You must add oil and make sure that the oil level is in the C Range.

1. Follow all of the oil manufacturer’s precautions.
2. Be sure the vehicle is on the level ground in P (Park) with the parking brake set and the wheels blocked.
3. Turn the engine on and allow the engine to reach normal operating temperature.
4. Turn the engine off, remove the oil filler cap and pull the dipstick out. Wait for 15 minutes for the oil to return to the oil pan.
5. Wipe the dipstick clean and re-insert it fully.
6. Pull out the dipstick out again and check the level. The level should be in the C range.

7. If the level is in the D range, add enough engine oil to bring the level up to the C range.

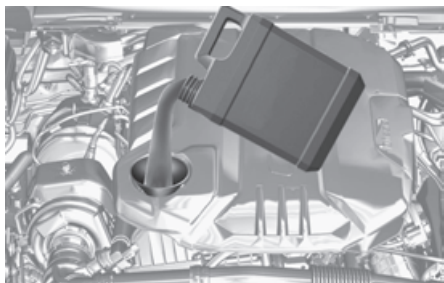

Use only the specified engine oil (Refer to the “Recommended lubricants and capacities” section in chapter 2).

NOTICE

To prevent damage to your engine:

- Do not spill engine oil when adding or changing engine oil. Wipe off spilled oil immediately.
 - The engine oil consumption may increase while you break in a new vehicle and it will be stabilized after driving 6,000 km (4,000 miles).
 - The engine oil consumption can be affected by driving habits, climate conditions, traffic conditions, oil quality, etc. Therefore, it is recommended that you inspect the engine oil level regularly and refill it if necessary.
-

Checking the engine oil and filter

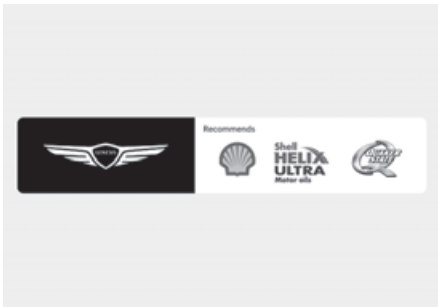

- We recommend that the engine oil and filter be changed by an authorized retailer of Genesis Branded products according to the Maintenance Schedule at the beginning of this chapter.
- If the maintenance schedule to replace engine oil is exceeded, the engine oil performance may deteriorate, and the engine condition may be affected. Therefore, replace the engine oil according to the maintenance schedule.
- To keep the engine in optimal condition, use the recommended engine oil and filter. If the recommended engine oil and filter are not used, replace it according to the maintenance schedule under severe usage conditions.
- The purpose of the maintenance schedule for engine oil replacement is to prevent oil deterioration and it is irrelevant to oil consumption. Check and refill engine oil regularly.

CAUTION

The engine oil is very hot immediately after the vehicle has been driven and can cause burns during replacement. Replace the engine oil after the engine oil has cooled down.

WARNING

Used engine oil may cause irritation or cancer of the skin if left in contact with the skin for prolonged periods of time. Used engine oil contains chemicals that have caused cancer in laboratory animals. Always protect your skin by washing your hands thoroughly with soap and warm water as soon as possible after handling used oil.

NOTICE

Never add any additives to the engine oil. Engine oil additives can change the properties of engine oil and may cause serious engine failure.

Engine coolant

The high-pressure cooling system has a reservoir filled with year-round antifreeze coolant. The reservoir is filled at the factory.

Check the antifreeze protection and coolant level at least once a year, at the beginning of the winter season and before traveling to a colder climate.

Checking the coolant level

2.0L T-GDI

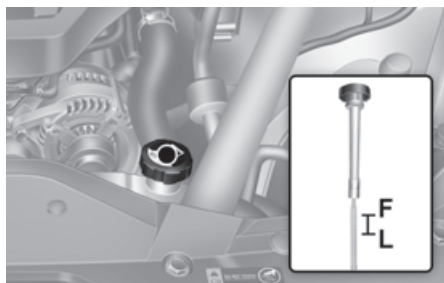

3.3L T-GDI

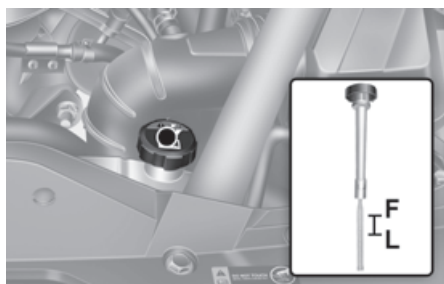

2.2L TCI

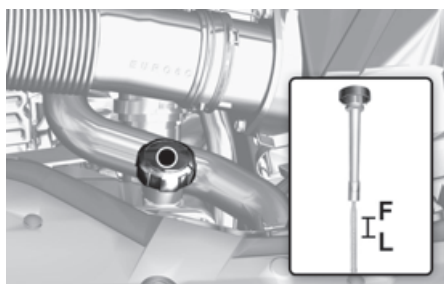

Check the condition and connections of all cooling system hoses and heater hoses. Replace any swollen or deteriorated hoses.

The coolant level should be filled between the MAX and the MIN marks on the side of the coolant reservoir when the engine is cool.

If the coolant level is low, add enough distilled (deionized) water to bring the level to the MAX mark, but do not overfill. If frequent additions are required, we recommend that you see an authorized retailer of Genesis Branded products for a cooling system inspection.

⚠ WARNING



Never remove the engine coolant cap or the drain plug while the engine and radiator are hot. Hot coolant and steam may blow out under pressure, causing serious injury.

Turn the vehicle off and wait until the engine cools down. Use extreme care when removing the engine coolant cap. Wrap a thick towel around it, and turn it counterclockwise slowly to the first stop. Step back while the pressure is released from the cooling system. When you are sure all the pressure has been released, press down on the cap, using a thick towel, and continue turning counterclockwise to remove it.

i Information

The coolant level is influenced by the engine temperature. Before checking or refilling the coolant, turn the engine off.

! WARNING



The electric motor for the cooling fan may continue to operate or start up when the engine is not running and can cause serious injury. Keep hands, clothing and tools away from the rotating fan blades of the cooling fan.

Always turn off the vehicle unless the vehicle has to be inspected with the engine on. Be cautious as the cooling fan may operate if the negative (-) battery terminal is not disconnected.

! WARNING

Make sure the coolant cap is properly closed after refilling coolant. Otherwise the engine could be overheated while driving.

1. Check if the coolant cap label is straight in front.

Engine compartment front view



2. Make sure that the tiny protrusions inside the coolant cap are securely interlocked.



Recommended coolant

- When adding coolant, use only deionized water, distilled water or soft water for your vehicle and never mix hard water in the coolant filled at the factory.
- An incorrect coolant mixture can result in severe malfunction or engine damage.
- The engine in your vehicle has aluminum engine parts and must be protected by an phosphate-based ethylene glycol coolant to prevent corrosion and freezing.
- Do not use alcohol or methanol coolant or mix them with the specified coolant.
- Do not use a solution that contains more than 60% antifreeze or less than 35% antifreeze, which would reduce the effectiveness of the solution.

For mixing percentage, refer to the following table:

Ambient Temperature	Mixture Percentage (volume)	
	Antifreeze	Water
-15°C (5°F)	35	65
-25°C (-13°F)	40	60
-35°C (-31°F)	50	50
-45°C (-49°F)	60	40

i Information

If in doubt about the mix ratio, a 50% water and 50% antifreeze mix is the easiest to mix together as it will be the same quantity of each. It is suitable to use for most temperature ranges of -35°C (-31°F) and higher.

Changing coolant

We recommend that coolant be changed by an authorized retailer of Genesis Branded products according to the Maintenance Schedule at the beginning of this chapter.

WARNING

Do not use engine coolant or antifreeze in the washer fluid reservoir.

Engine coolant can severely obscure visibility when sprayed on the windshield and may cause loss of vehicle control resulting in an accident.

Engine coolant may also cause damage to paint and body trim.

NOTICE

To prevent damage to engine parts, put a thick towel around the engine coolant cap before refilling the coolant to prevent the coolant from overflowing into engine parts, such as the alternator.

Brake fluid

Checking the brake fluid level

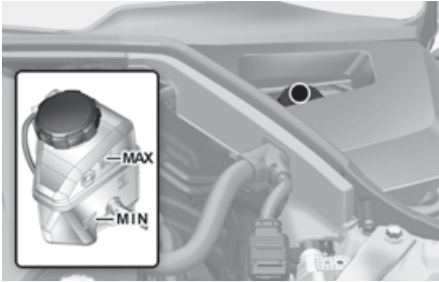

Check the fluid level in the reservoir periodically. The fluid level should be between MAX and MIN marks on the side of the reservoir.

Before removing the reservoir cap and adding brake fluid, clean the area around the reservoir cap thoroughly to prevent brake fluid contamination.

If the level is low, add the specified brake fluid to the MAX level. The level will fall with accumulated mileage. This is a normal condition associated with the wear of the brake linings. If the fluid level is excessively low, we recommend that the brake system be checked by an authorized retailer of Genesis Branded products.

WARNING

If the brake system requires frequent additions of fluid this could indicate a leak in the brake system. We recommend that the vehicle be inspected by an authorized retailer of Genesis Branded products.

WARNING

Do not let brake fluid enter into your eyes. If brake fluid gets in your eyes, flush your eyes with clean water for at least 15 minutes and get immediate medical attention.

NOTICE

- Do not allow brake fluid to contact the vehicle's body paint, as paint damage will result.
 - Never use brake fluid which has been exposed to open air for an extended time, as its quality cannot be guaranteed.
 - Do not use the wrong type of brake fluid. A few drops of mineral based oil, such as engine oil in your brake system can damage brake system parts.
-

Information

Use only the specified brake fluid (refer to the "Recommended lubricants and capacities" section in chapter 2).

Washer fluid

Checking the washer fluid level

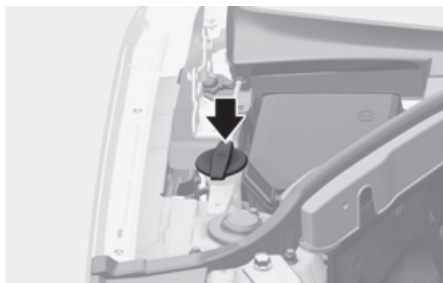

Check the fluid level in the washer fluid reservoir and add fluid if necessary. Plain water may be used if washer fluid is not available. However, use washer solvent with antifreeze characteristics in cold climates to prevent freezing.

WARNING

To prevent serious injury or death, take the following safety precautions when using washer fluid:

- Do not use engine coolant or antifreeze in the washer fluid reservoir. Engine coolant can severely obscure visibility when sprayed on the windshield and may cause loss of vehicle control resulting in an accident or damage to paint and body trim.
 - Do not allow sparks or flame to contact the washer fluid or the washer fluid reservoir. Washer fluid may contain alcohol and can be flammable.
 - Do not drink washer fluid and avoid contact with skin. Washer fluid is harmful to humans and animals.
 - Keep washer fluid away from children and animals.
-

Fuel filter (for diesel engine)

Draining water from fuel filter

The fuel filter in the diesel engine separates water from fuel and prevents water from accumulating.

When water is accumulated inside the fuel filter, the fuel filter () warning light illuminates with the engine on.

If this occurs, we recommend that you have the system checked by an authorized retailer of Genesis Branded products.

NOTICE

When accumulated water is not drained at the proper timing, water may permeate in the fuel filter, damaging the major vehicle components, such as the fuel system.

Fuel filter cartridge replacement

We recommend the fuel filter cartridge be replaced by an authorized retailer of Genesis Branded products according to the Maintenance Schedule at the beginning of this chapter.

Air cleaner

Filter replacement

2.0L T-GDI

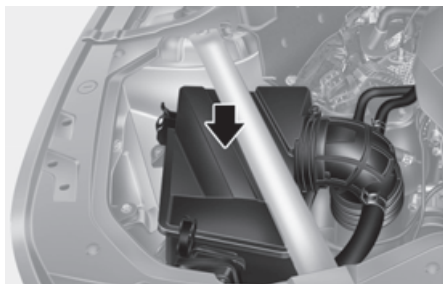

3.3L T-GDI (Passenger side)

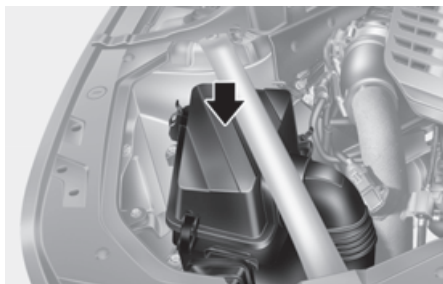

3.3 T-GDI (Driver side)

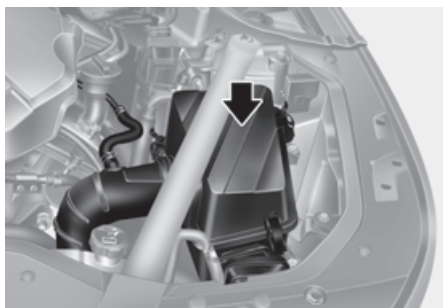

2.2L TCI

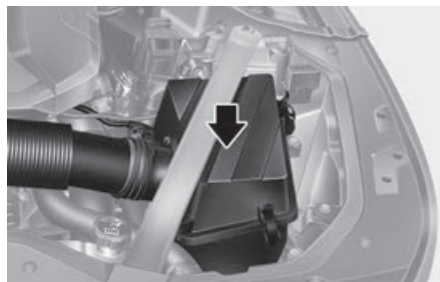

Do not attempt to wash or to rinse it, as water will damage the filter.

If soiled, the air cleaner filter must be replaced.

We recommend that you visit an authorized retailer of Genesis Branded products to replace air cleaner filter.

Replace the filter according to the Maintenance Schedule.

i Information

If the vehicle is operated in extremely dusty or sandy areas, replace the air cleaner filter more often than the usual recommended intervals (Refer to the “Maintenance under severe usage conditions (for Europe, except Russia)” section in this chapter).

NOTICE

- Do not drive with the air cleaner filter removed. This will result in excessive engine wear.
- When removing the air cleaner filter, be careful that dust or dirt does not enter the air intake, or damage may result.
- We recommend that you use parts for replacement from an authorized retailer of Genesis Branded products.

Cabin air filter

Filter inspection

The cabin air filter should be replaced according to the Maintenance Schedule. If the vehicle is operated in severely air-polluted cities or on dusty rough roads for a long period, it should be inspected more frequently and replaced sooner. Replace the cabin air filter by following the procedure below and be careful to avoid damaging other components.

Filter replacement

1. Open the glove box and remove the support rod (1).

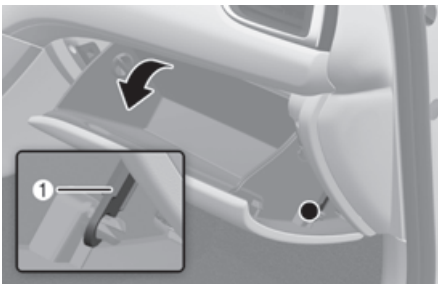

2. Remove the stoppers on both sides to allow the glove box to hang freely on the hinges.

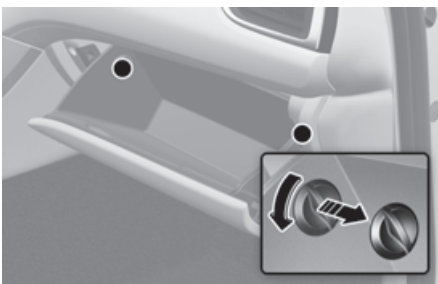

3. Pull out the cover while Pressing and holding the lock on the left side of the cover.



4. Replace the cabin air filter.
5. Reassemble in the reverse order of disassembly.

NOTICE



Install a new cabin air filter in the correct direction with the arrow symbol (↴) facing downwards, to prevent noise and reduce effectiveness.

Wiper blades

Blade inspection

Contamination of either the windshield or the wiper blades with foreign matter can reduce the effectiveness of the windshield wipers.

Common sources of contamination are insects, tree sap, and hot wax treatments used by some commercial car washes. If the blades are not wiping properly, clean both the window and the blades with a good cleaner or mild detergent, and rinse thoroughly with clean water.

NOTICE

To prevent damage to the wiper blades, arms or other components, do not:

- Use gasoline, kerosene, paint thinner, or other solvents on or near them.
- Attempt to move the wipers manually.
- Use non-specified wiper blades.

***i* Information**

Commercial hot waxes applied by automatic car washes have been known to make the windshield difficult to clean.

***i* Information**

Wiper blades are consumable items. Normal wear of the wipers may not be covered by your vehicle warranty.

Blade replacement

When the wipers no longer clean adequately, the blades may be worn or cracked, and require replacement.

NOTICE

- In order to prevent damage to the hood and the wiper arms, the wiper arms should only be lifted when in the top wiping position.
- Always return the wiper arms to the windshield before driving.

Front windshield wiper blade replacement

1. Within 20 seconds of turning off the engine, lift up (or push down) and hold the wiper lever to the MIST (or 1x) position for about 2 seconds until the wipers move to the top wipe position.

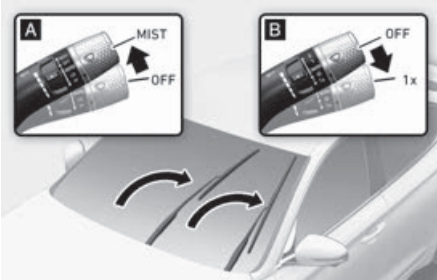

[A] Type A
[B] Type B

2. Lift up the wiper blade clip (1). Then pull down the wiper blade (2). Remove the wiper blade from the wiper arm.

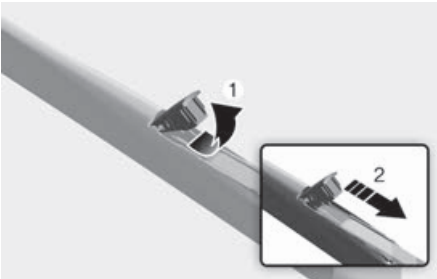

3. Install a new wiper blade assembly in the reverse order of removal (3).



4. With the engine on, turn the wiper switch to MIST/LOW/HIGH position to return the wipers to the bottom resting position.

NOTICE

- Avoid the wipers from touching the windshield when the wiper blade is disassembled to prevent windshield damage.
- The wiper may not operate for about 10 seconds if the wiper is operated without washer fluid or the blades are frozen to prevent damage to the motor.

Rear window wiper blade replacement

 if equipped

1. Raise the wiper arm and then rotate the wiper blade assembly (1).
2. Pull out the wiper blade assembly (2).

Shooting Brake

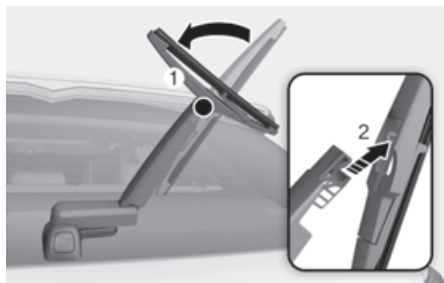

3. Install the new blade assembly by inserting the center part into the slot in the wiper arm until it clicks into place (3).

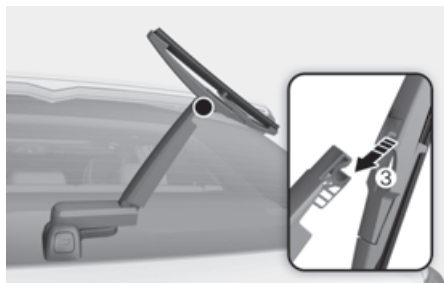

4. Make sure the blade assembly is installed firmly by trying to pull it slightly.
5. Rotate back the blade assembly so that it aligns with the wiper arm.

To prevent damage to the wiper arms or other components, we recommend that you have the wiper blades replaced by an authorized retailer of Genesis Branded products.

Battery

WARNING

To prevent **SERIOUS INJURY** or **DEATH** to you or bystanders, always follow these precautions when working near or handling the battery:



Always read and follow instructions carefully when handling a battery.



Wear eye protection designed to protect the eyes from acid splashes.



Keep all flames, sparks, or smoking materials away from the battery.



Hydrogen is always present in battery cells, is highly combustible, and may explode if ignited.



Keep batteries out of reach of children.



Batteries contain sulfuric acid which is highly corrosive. Do not allow acid to contact your eyes, skin or clothing.

If acid gets into your eyes, flush your eyes with clean water for at least 15 minutes and get immediate medical attention. If acid gets on your skin, thoroughly wash the area. If you feel pain or a burning sensation, get medical attention immediately.

- When lifting a plastic-cased battery, excessive pressure on the case may cause battery acid to leak. Lift with a battery carrier or with your hands on opposite corners.
 - Do not attempt to jump start your vehicle if your battery is frozen.
 - Never attempt to recharge the battery when the vehicle's battery cables are connected to the battery.
 - The electrical ignition system works with high voltage. Never touch these components with the engine running or when the Engine Start/Stop button is in the ON position.
-

NOTICE

Always follow these instructions when handling your vehicle's battery to prevent damage to your battery:

- When you do not use the vehicle for a long time in a low temperature area, disconnect the battery and keep it indoors.
 - Always charge the battery fully to prevent battery case damage in low temperature areas.
 - Prevent liquid from wetting the battery terminals. The performance of the battery may be degraded, and may cause injury. Be cautious when loading liquid in the trunk (or tailgate).
 - Do not tilt the battery.
 - If you connect unauthorized electronic devices to the battery, the battery may be discharged. Never use unauthorized devices.
-

For best battery service

- Keep the battery securely mounted.
- Keep the battery top clean and dry.
- Keep the terminals and connections clean, tight, and coated with petroleum jelly or terminal grease.
- Rinse any spilled electrolyte from the battery immediately with a solution of water and baking soda.
- If the vehicle is not going to be used for an extended time, disconnect the battery cables.

Battery Replacement



When replacing the battery, disconnect the negative (-) cable (1) and remove the positive (+) battery fuse box (2). Remove the trunk (or tailgate) panel and spare wheel. Place the spare wheel on the floor with the finished side up so as not to damage. Then remove the spare wheel bracket (3) followed by the battery hold down mounting bracket (4).

i Information

For vehicles with power trunk (or tailgate), note that the power trunk (or tailgate) needs to be reset after the battery has been replaced. For more information, refer to the “Resetting the power trunk” or “Resetting the power tailgate” section in chapter 5.

NOTICE

Make sure the battery is installed securely when it is replaced. If the battery vibrates while driving, the case and electrode plate can be damaged.

i Information

For batteries marked with UPPER and LOWER

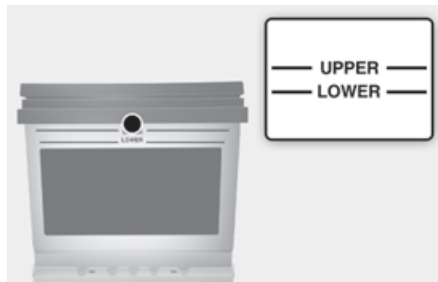

If your vehicle is equipped with a battery marked with LOWER (MIN) and UPPER (MAX) on the side, you should check the electrolyte level.

The electrolyte level should be between LOWER (MIN) and UPPER (MAX). When the electrolyte level is low, add distilled (or de-mineralized) water. (Never add sulfuric acids or other electrolyte).

Be careful not to spill distilled (or demineralized) water over the battery surface or other adjacent components.

Also, do not overfill the battery cells.

If not, it may corrode the battery or other components. Finally, securely close the cell cap. However, we recommend you to contact an authorized retailer of Genesis Branded products for better battery service.

Battery capacity label

Type A



- (1) AGM80-DIN: The Genesis Branded Vehicle model name of battery
- (2) 12V: The nominal voltage
- (3) 80Ah (20HR): The nominal capacity (in Ampere hours)
- (4) CCA 850A: The cold-test current in amperes by SAE/EN
- (5) RC 155min: The nominal reserve capacity (in min.)

The actual battery label in the vehicle may differ from the illustration.

Type B

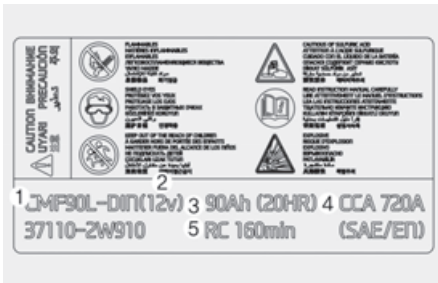

- (1) CMF90L-DIN: The Genesis Branded Vehicle model name of battery
- (2) 12V: The nominal voltage
- (3) 90Ah (20HR): The nominal capacity (in Ampere hours)
- (4) CCA 720A: The cold-test current in amperes by SAE/EN
- (5) RC 160min: The nominal reserve capacity (in min.)

Battery recharging

By battery charger

Your vehicle has a maintenance-free, calcium-based battery.

- If the battery becomes discharged over a short time (because, for example, the headlights or interior lights were left on while the vehicle was not in use), recharge it by slow charging (trickle) for 10 hours.
- If the battery gradually discharges because of high electrical load while the vehicle is being used, recharge it at 20-30A for two hours.

⚠ WARNING

Always follow these instructions when recharging your vehicle's battery to avoid the risk of **SERIOUS INJURY** or **DEATH** from explosions or acid burns:

- Before performing maintenance or recharging the battery, turn off all accessories and stop the engine.
- Keep all flames, sparks, or smoking materials away from the battery.
- Always work outdoors or in an area with plenty of ventilation.
- Wear eye protection when checking the battery during charging.
- The battery must be removed from the vehicle and placed in a well ventilated area.
- Watch the battery during charging, and stop or reduce the charging rate if the battery cells begin boiling violently.

- The negative battery cable must be removed first and installed last when the battery is disconnected. Disconnect the battery charger in the following order:
 1. Turn off the battery charger main switch.
 2. Unhook the negative clamp from the negative battery terminal.
 3. Unhook the positive clamp from the positive battery terminal.
- We recommend that you use batteries for replacement from an authorized retailer of Genesis Branded products.

NOTICE

AGM battery

- Absorbent Glass Mat (AGM) batteries are maintenance-free and we recommend that the AGM battery be serviced by an authorized retailer of Genesis Branded products. For charging your AGM battery, use only fully automatic battery chargers that are specially developed for AGM batteries.
- When replacing the AGM battery, we recommend that you use parts for replacement from an authorized retailer of Genesis Branded products.
- Do not open or remove the cap on top of the battery. This may cause leaks of internal electrolyte that could result in severe injury.

By jump starting

After a jump start from a good battery, drive the vehicle for 20-30 minutes before it is shutoff. The vehicle may not restart if you shut it off before the battery had a chance to adequately recharge. Refer to the “Jump starting” in chapter 8 for more information on jump starting procedures.

i Information



An inappropriately disposed battery can be harmful to the environment and human health. Dispose of the battery according to your local law(s) or regulation.

Reset items

The following items may need to be reset after the battery has been discharged or the battery has been disconnected.

- Fuel economy/Driving info/Since refueling/Accumulated info (refer to the chapter 4)
- Integrated memory system (refer to chapter 5)
- Power window (refer to chapter 5)
- Sunroof (refer to chapter 5)
- Power trunk (or tailgate) (refer to chapter 5)
- Climate control system (refer to chapter 5)
- Clock (refer to Infotainment system manual)
- Infotainment system (refer to Infotainment system manual)

Tires and wheels

WARNING

Tire failure may cause loss of vehicle control resulting in an accident. To reduce risk of **SERIOUS INJURY** or **DEATH**, take the following precautions:

- Inspect your tires monthly for proper inflation as well as wear and damage.
- The recommended cold tire pressure for your vehicle can be found in this manual and on the tire label located on the driver's side center pillar. Always use a tire pressure gauge to measure tire pressure. Tires with too much or too little pressure wear unevenly causing poor handling.
- Check the pressure of the spare every time you check the pressure of the other tires on your vehicle.
- Replace tires that are worn, show uneven wear, or are damaged. Worn tires can cause loss of braking effectiveness, steering control, or traction.
- Always replace tires with the same size, type, construction and tread pattern as each tire that was originally supplied with this vehicle. Using tires and wheels other than the recommended sizes could cause unusual handling characteristics, poor vehicle control, or negatively affect your vehicle's Anti-Lock Brake System (ABS) resulting in a serious accident.

Tire care

For proper maintenance, safety, and maximum fuel economy, you must always maintain recommended tire inflation pressures and stay within the load limits and weight distribution recommended for your vehicle.



All specifications (sizes and pressures) can be found on a label attached to the driver's side center pillar.

Recommended cold tire inflation pressures

All tire pressures (including the spare) should be checked when the tires are cold. "Cold tires" means the vehicle has not been driven for at least three hours or driven less than one 1.6 km (1 mile).

Warm tires normally exceed recommended cold tire pressures by 28 to 41 kPa (4 to 6 psi). Do not release air from warm tires to adjust the pressure or the tires will be under-inflated. For recommended inflation pressure, refer to the "Tires and wheels" section in chapter 2.

⚠ WARNING

Recommended pressures must be maintained for the best ride, vehicle handling, and minimum tire wear.

Over-inflation or under-inflation can reduce tire life, adversely affect vehicle handling, and lead to sudden tire failure that could result in loss of vehicle control resulting in an accident.

Severe under-inflation can lead to severe heat build-up, causing blowouts, tread separation and other tire failures that can result in the loss of vehicle control resulting in an accident. This risk is much higher on hot days and when driving for long periods at high speeds.

⚠ CAUTION

- Under-inflation results in excessive wear, poor handling and reduced fuel economy. Wheel deformation is also possible. Keep your tire pressures at the proper levels. If a tire frequently needs refilling, we recommend it be checked by an authorized retailer of Genesis Branded products.
 - Over-inflation produces a harsh ride, excessive wear at the center of the tire tread, and a greater possibility of damage from road hazards.
-

Check tire inflation pressure

Check your tires, including the spare tire, once a month or more.

How to check

Use a good quality tire pressure gauge to check tire pressure. You can not tell if your tires are properly inflated simply by looking at them. Radial tires may look properly inflated when they are under-inflated.

Remove the valve cap from the tire valve stem. Press the tire gauge firmly onto the valve to get a pressure measurement. If the cold tire inflation pressure matches the recommended pressure on the tire and loading information label, no further adjustment is necessary. If the pressure is low, add air until you reach the recommended pressure. Make sure to put the valve caps back on the valve stems. Without the valve cap, dirt or moisture could get into the valve core and cause air leakage. If a valve cap is missing, install a new one as soon as possible.

If you overfill the tire, release air by pushing on the metal stem in the center of the tire valve. Recheck the tire pressure with the tire gauge. Be sure to put the valve caps back on the valve stems. Without the valve cap, dirt or moisture could get into the valve core and cause air leakage. If a valve cap is missing, install a new one as soon as possible.

Tire rotation

To equalize tread wear, Genesis Branded Vehicle recommends that the tires rotated according to the maintenance schedule or sooner if irregular wear develops.

During rotation, check the tires for correct balance.

When rotating tires, check for uneven wear and damage. Abnormal wear is usually caused by incorrect tire pressure, improper wheel alignment, out-of-balance wheels, severe braking or severe cornering. Look for bumps or bulges in the tread or side of the tire. Replace the tire if you find any of these conditions. Replace the tire if fabric or cord is visible. After rotation, be sure to bring the front and rear tire pressures to specification and check wheel lug nuts tightness (proper torque is 11-13 kgf.m [79-94 lbf.ft]).

18 inch tire

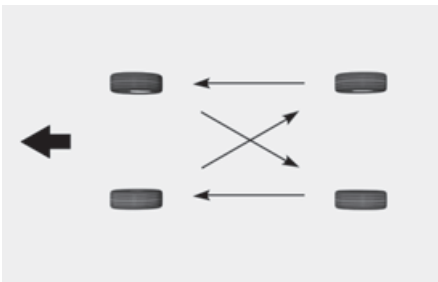

19 inch tire

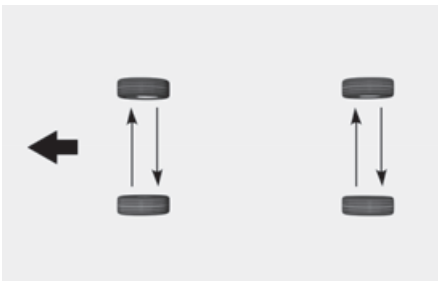

Disc brake pads should be inspected for wear whenever tires are rotated.

i Information

The outside and inside of the unsymmetrical tire is distinguishable. When installing an unsymmetrical tire, be sure to install the side marked “outside” face the outside. If the side marked “inside” is installed on the outside, it will have a negative effect on vehicle performance.

WARNING

- Do not use the compact spare tire for tire rotation.
- Do not mix bias ply and radial ply tires under any circumstances. This may cause unusual handling characteristics that may cause loss of vehicle control resulting in an accident.

Wheel alignment and tire balance

The wheels on your vehicle were aligned and balanced carefully at the factory to give you the longest tire life and best overall performance.

In most cases, you will not need to have your wheels aligned again. However, if you notice unusual tire wear or your vehicle pulling one way or the other, the alignment may need to be reset.

If you notice your vehicle vibrating when driving on a smooth road, your wheels may need to be rebalanced.

NOTICE

Incorrect wheel weights can damage your vehicle's aluminum wheels. Use only approved wheel weights.

Tire replacement



[A] Tread wear indicator

If the tire is worn evenly, a tread wear indicator will appear as a solid band across the tread. This shows there is less than 1.6 mm (1/16 in.) of tread left on the tire. Replace the tire when this happens.

Do not wait for the band to appear across the entire tread before replacing the tire.

⚠ WARNING

To reduce the risk of DEATH or SERIOUS INJURY:

- Replace tires that are worn, show uneven wear, or are damaged. Worn tires can cause loss of braking effectiveness, steering control, and traction.
- Always replace tires with the same size as each tire that was originally supplied with this vehicle. Using tires and wheels other than the recommended sizes could cause unusual handling characteristics, poor vehicle control, or negatively affect your vehicle's Anti-Lock Brake System (ABS) resulting in a serious accident.
- When replacing tires (or wheels), it is recommended to replace the two front or two rear tires (or wheels) as a pair. Replacing just one tire can seriously affect your vehicle's handling.
- Tires degrade over time, even when they are not being used. Regardless of the remaining tread, Genesis Branded Vehicle recommends that tires be replaced after six (6) years of normal service.
- Heat caused by hot climates or frequent high loading conditions can accelerate the aging process. Failure to follow this warning may cause sudden tire failure, which could lead to a loss of vehicle control resulting in an accident.

Compact spare tire replacement

 if equipped

A compact spare tire has a shorter tread life than a regular size tire. Replace it when you can see the tread wear indicator bars on the tire. The replacement compact spare tire should be the same size and design tire as the one provided with your new vehicle and should be mounted on the same compact spare tire wheel. The compact spare tire is not designed to be mounted on a regular size wheel, and the compact spare tire wheel is not designed for mounting a regular size tire.

WARNING

The original tire should be repaired or replaced as soon as possible to avoid failure of the compact spare tire and loss of vehicle control resulting in an accident. The compact spare tire is for emergency use only. Do not operate your vehicle over 80 km/h (50 mph) when using the compact spare tire.

Wheel replacement

When replacing the metal wheels for any reason, make sure the new wheels are equivalent to the original factory units in diameter, rim width and offset.

Tire traction

Tire traction can be reduced if you drive on worn tires, tires that are improperly inflated or on slippery road surfaces. Tires should be replaced when tread wear indicators appear. To reduce the possibility of losing control, slow down whenever there is rain, snow or ice on the road.

Tire maintenance

In addition to proper inflation, correct wheel alignment helps to decrease tire wear. If you find a tire is worn unevenly, have your dealer check the wheel alignment.

When you have new tires installed, make sure they are balanced. This will increase vehicle ride comfort and tire life. Additionally, a tire should always be rebalanced if it is removed from the wheel.

Tire sidewall labeling

This information identifies and describes the fundamental characteristics of the tire and also provides the tire identification number (TIN) for safety standard certification. The TIN can be used to identify the tire in case of a recall.

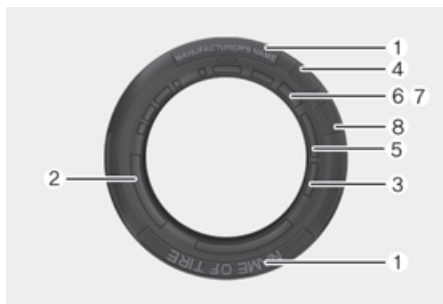

(1) *Manufacturer or brand name*

Manufacturer or brand name is shown.

(2) *Tire size designation*

A tire's sidewall is marked with a tire size designation. You will need this information when selecting replacement tires for your car. The following explains what the letters and numbers in the tire size designation mean.

Example tire size designation:

(These numbers are provided as an example only; your tire size designator could vary depending on your vehicle.)

225/45R18 95Y

225 - Tire width in millimeters.

45 - Aspect ratio. The tire's section height as a percentage of its width.

R - Tire construction code (Radial).

18 - Rim diameter in inches.

95 - Load Index, a numerical code associated with the maximum load the tire can carry.

Y - Speed Rating Symbol. See the speed rating chart in this section for additional information.

Wheel size designation

Wheels are also marked with important information that you need if you ever have to replace one. The following explains what the letters and numbers in the wheel size designation mean.

Example wheel size designation:

8.0J X 18

8.0 - Rim width in inches.

J - Rim contour designation.

18 - Rim diameter in inches.

Tire speed ratings

The chart below lists many of the different speed ratings currently being used for passenger vehicle tires. The speed rating is part of the tire size designation on the sidewall of the tire. This symbol corresponds to that tire’s designed maximum safe operating speed.

Speed Rating Symbol	Maximum Speed
S	180 km/h (112 mph)
T	190 km/h (118 mph)
H	210 km/h (130 mph)
V	240 km/h (149 mph)
W	270 km/h (168 mph)
Y	300 km/h (186 mph)

i Information

For tires above 240 km/h (149 mph), tire manufacturers sometimes use the code “ZR”

(3) Checking tire life (TIN : Tire Identification Number)

Any tires that are over six years old, based on the manufacturing date, (including the spare tire) should be replaced by new ones. You can find the manufacturing date on the tire sidewall (possibly on the inside of the wheel), displaying the DOT Code. The DOT Code is a series of numbers on a tire consisting of numbers and English letters. The manufacturing date is designated by the last four digits (characters) of the DOT code.

DOT : XXXX XXXX OOOO

The front part of the DOT shows a plant code number, tire size and tread pattern and the last four numbers indicate week and year manufactured.

For example:

DOT XXXX XXXX 1523 represents that the tire was produced in the 15th week of 2023.

(4) Genesis exclusive tire

Genesis Branded Vehicle recommends that tires designed specifically for Genesis vehicles be used. You may find the marking “GOE” (Genesis Original Equipment) embossed on the tire sidewall.

(5) Tire ply composition and material

The number of layers or plies of rubber-coated fabric in the tire. Tire manufacturers also must indicate the materials in the tire, which include steel, nylon, polyester, and others. The letter “R” means radial ply construction; the letter “D” means diagonal or bias ply construction; and the letter “B” means belted-bias ply construction.

(6) Maximum permissible inflation pressure

This number is the greatest amount of air pressure that should be put in the tire. Do not exceed the maximum permissible inflation pressure. Refer to the Tire and Loading Information label for recommended inflation pressure.

(7) Maximum load rating

This number indicates the maximum load in kilograms and pounds that can be carried by the tire. When replacing the tires on the vehicle, always use a tire that has the same load rating as the factory installed tire.

(8) Uniform tire quality grading

Quality grades can be found where applicable on the tire sidewall between tread shoulder and maximum section width.

For example:

TREADWEAR 200

TRACTION AA

TEMPERATURE A

Tread wear

The tread wear grade is a comparative rating based on the wear rate of the tire when tested under controlled conditions on a specified government test course. For example, a tire graded 150 would wear one-and-a-half times (1½) as well on the government course as a tire graded 100.

The relative performance of tires depends upon the actual conditions of their use, however, and may depart significantly from the norm due to variations in driving habits, service practices and differences in road characteristics and climate.

These grades are molded on the sidewalls of passenger vehicle tires. The tires available as standard or optional equipment on your vehicle may vary with respect to grade.

Traction - AA, A, B & C

The traction grades, from highest to lowest, are AA, A, B and C. Those grades represent the tire's ability to stop on wet pavement as measured under controlled conditions on specified government test surfaces of asphalt and concrete. A tire marked C may have poor traction performance.

 WARNING

The traction grade assigned to this tire is based on straight ahead braking traction tests, and does not include acceleration, cornering, hydroplaning, or peak traction characteristics.

Temperature - A, B & C

The temperature grades are A (the highest), B and C representing the tire's resistance to the generation of heat and its ability to dissipate heat when tested under controlled conditions on a specified indoor laboratory test wheel.

Sustained high temperature can cause the material of the tire to degenerate and reduce tire life, and excessive temperature can lead to sudden tire failure. Grades B and A represent higher levels of performance on the laboratory test wheel than the minimum required by law.

 **WARNING**

The temperature grade for this tire is established for a tire that is properly inflated and not overloaded. Excessive speed, under-inflation, over-inflation, or excessive loading, either separately or in combination, can cause heat build-up and possible sudden tire failure. This may cause loss of vehicle control resulting in an accident.

Low aspect ratio tires

The aspect ratio is lower than 50 on low aspect ratio tires.

Because low aspect ratio tires are optimized for handling and braking, their sidewall is a little stiffer than a standard tire. Also low aspect ratio tires tend to be wider and consequently have a greater contact patch with the road surface. In some instances they may generate more road noise compared with standard tires.

 **CAUTION**

The side wall of a low aspect ratio tire is shorter than the normal one. Thus, the low-aspect wheel and tire are easily damaged. Follow the below instructions.

- When driving on a rough road or driving off a road, be careful not to damage the tires and wheels. After driving, inspect the tires and wheels.
 - When passing over a pothole, speed bump, manhole, or curb stone, drive the vehicle slowly so as not to damage the tires and wheels.
 - When there is an impact on a tire, inspect the tire condition. Or, you can contact an authorized retailer of Genesis Branded products.
 - Inspect the tire condition and pressure every 3,000 km (1,800 miles) to prevent tire damage.
 - It is difficult to recognize a tire damage only with your eyes. When there is a slight hint of a tire damage, check and replace the tire to prevent the damage caused by air leakage.
 - When a tire is damaged while driving on a rough road, off a road, or over obstacles, such as a pothole, manhole, or curb stone, your warranty does not cover the damage.
 - The tire information is specified on the tire side wall.
-

Fuses

Blade type



Cartridge type



Multi type

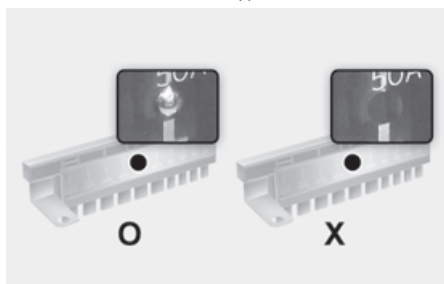

Midi type



A vehicle's electrical system is protected from electrical overload damage by fuses.

This vehicle has 4 fuse panels, Two are located in the driver's side panel bolster and engine compartment, the other two are located in the trunk (or tailgate).

If any of your vehicle's lights, accessories, or controls do not work, check the appropriate circuit fuse. If a fuse has blown, the element inside the fuse will be melted or broken.

If the electrical system does not work, first check the driver's side fuse panel. Before replacing a blown fuse, turn the engine and all switches off, and then disconnect the negative battery cable. Always replace a blown fuse with one of the same rating.

If the replacement fuse blows, this indicates an electrical problem. Avoid using the system involved. We recommend that you immediately consult an authorized retailer of Genesis Branded products.

WARNING

Never replace a fuse with anything but another fuse of the same rating.

- A higher capacity fuse could cause damage and possibly cause a fire.
- Do not install a wire or aluminum foil instead of the proper fuse - even as a temporary repair. It may cause extensive wiring damage and possibly a fire.

NOTICE

Do not use a screwdriver or any other metal object to remove fuses because it may cause a short circuit and damage the system.

Instrument panel fuse replacement

1. Turn the vehicle off.
2. Turn all other switches off.
3. Open the fuse panel cover.

Driver's side



4. Refer to the label on the inside of the fuse panel cover to locate the suspected fuse location.
5. Pull the suspected fuse straight out. Use the removal tool (1) provided in the engine compartment fuse panel.



6. Check the removed fuse; replace it if it is blown. Spare fuses are provided in the instrument panel fuse panels (or in the engine compartment fuse panel).
7. Push in a new fuse of the same rating, and make sure it fits tightly in the clips. If it fits loosely, we recommend that you consult an authorized retailer of Genesis Branded products.

In an emergency, if you do not have a spare fuse, use a fuse of the same rating from a circuit you may not need for operating the vehicle, such as the cigarette lighter fuse.

If the headlights or other electrical components do not work and the fuses are undamaged, check the fuse panel in the engine compartment. If a fuse is blown, it must be replaced with the same rating.

Engine compartment panel fuse replacement

Blade fuse/Cartridge fuse

1. Turn the vehicle off.
2. Turn all other switches off.
3. Remove the fuse panel cover by pressing the tap and pulling up.
4. Check the removed fuse and replace it if it is blown. To remove or insert the fuse, use the removal tool in the engine compartment fuse panel.

Blade type fuse



Cartridge type fuse



5. Push in a new fuse of the same rating, and make sure it fits tightly in the clips. If it does not fit tightly, we recommend that you consult an authorized retailer of Genesis Branded products.

NOTICE

After checking the fuse panel in the engine compartment, securely install the fuse panel cover. You may hear a clicking sound if the cover is securely latched. If it is not securely latched, electrical failure may occur from water contact.

Multi fuse/Midi fuse

Multi type





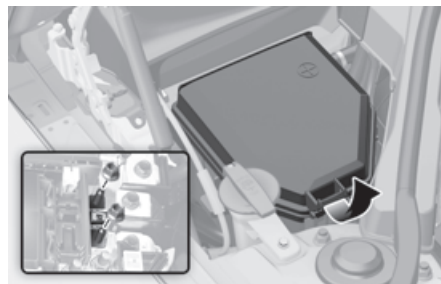









Midi type









If the multi fuse or midi fuse is blown, we recommend that you consult an authorized retailer of Genesis Branded products.







Instrument panel fuse panel (Driver's side fuse panel)

Fuse Name	Symbol	Fuse Rating	Circuit Protected
MULTI MEDIA1	¹ 	20A	[W/O ISG] Fuse - F11, F12 [With ISG] Low DC-DC Converter (Audio)
AIRBAG1	¹ 	15A	SRS Control Module (IG1)
MODULE10	¹⁰ 	10A	Driver Door Module, Driver/Passenger Power Outside Rearview Mirror, Driver IMS Control Module, Driver Air Lumbar Control Unit
STOP LAMP		10A	IBU, Stop Lamp Switch
CLUSTER		10A	Instrument Cluster, Head-Up Display
E-SHIFTER2	² 	10A	Electronic ATM Shift Lever
IBU3	³ 	10A	IBU (IG1)
MULTI MEDIA3	³ 	10A	[With ISG] Instrument Cluster, Head-Up Display, A/C Switch, Front Wireless Charger, Surround View Monitor [W/O ISG] Surround View Monitor
MULTI MEDIA2	² 	15A	A/V & Navigation Head Unit
MEMORY1	¹ 	10A	A/C Control Module, A/C Switch, Security Indicator Head-Up Display, Instrument Cluster (W/O ISG)

Fuse Name	Symbol	Fuse Rating	Circuit Protected
E-SHIFTER1	¹ E-SHIFTER	10A	Electronic ATM Shift Lever
MODULE11	¹¹ MODULE	10A	Multifunction Switch (IG1)
AIRBAG IND.	IND 	10A	Instrument Cluster, Overhead Console Lamp
IBU1	¹ IBU	15A	IBU (B+)
E-CALL	E-CALL	10A	Emergency Call Module
START		7.5A	IBU (B+), PCB Block (P/N Relay)
MODULE2	² MODULE	10A	IBU (IG2)
MODULE3	³ MODULE	10A	Driver Door Module, Stop Lamp Switch (G4KL/G6DP)

Fuse Name	Symbol	Fuse Rating	Circuit Protected
DOOR LOCK		20A	Door Lock Relay, Door Unlock Relay, Dead Lock Relay
SEAT HEATER		25A	Front Air Ventilation Seat Control Module Front Seat Warmer Control Module
TRUNK		10A	Trunk Lid Relay, Fuel Lid Relay
IBU2	² IBU	10A	Rain Sensor, Driver/Passenger Smart Key Outside Handle, IBU Driver/Passenger Power Outside Rearview Mirror
AIRBAG2	² 	15A	SRS Control Module (B+)
POWER OUTLET	POWER OUTLET	20A	Front Power Outlet
MODULE8	⁸ MODULE	10A	A/C Switch
MODULE7	⁷ MODULE	10A	IBU, Smart Cruise Control Module, AWD ECM, ECS Unit, Console Switch, Crash Pad Switch, Surround View Monitor, Multi-Function Camera Unit, Steering Angle Sensor, Steering Tilt & Telescopic Module, Dosing Control Module, Electronic Control Engine Mounting Module
POWER HANDLE	POWER HANDLE	15A	Steering Tilt & Telescopic Module
MODULE9	⁹ MODULE	10A	Driver Air Lumbar Control Unit
MODULE1	¹ MODULE	10A	Data Link Connector, Hazard Switch, Crash Pad Switch, Console Switch, Electronic Control Engine Mounting Module
CHARGER1	¹ CHARGER	10A	Front/Rear USB Charger, Front Tray USB Charger
MODULE5	⁵ MODULE	10A	A/C Control Module, A/C Switch, Electro Chromic Mirror, Data Link Connector, A/V & Navigation Head Unit, Low DC-DC Converter (Audio/AMP), AMP, IFS Module, Emergency Call (E-CALL) Module, Front Wireless Charger, Driver IMS Control Module, Front Air Ventilation Seat Control Module, Front/Rear Seat Warmer Control Module
SUNROOF		20A	Sunroof Control Unit (Glass)

Fuse Name	Symbol	Fuse Rating	Circuit Protected
PASSENGER P/WINDOW		25A	Rear Power Window Switch RH, Rear Safety Power Window Module RH, [LHD] Passenger Safety Power Window Module, [RHD] Driver Safety Power Window Module
CHARGER2	² 	10A	Rear USB Charger

Fuse Name	Symbol	Fuse Rating	Circuit Protected
WASHER		15A	Multifunction Switch
MDPS	 1	10A	MDPS Unit
DRIVER P/SEAT	 DRV	30A	Driver IMS Control Module, Driver Seat Manual Switch
PASSENGER P/SEAT	 PASS	30A	Passenger Seat Manual Switch, Passenger Walk In Relay Module
DRIVER P/WINDOW		25A	Rear Power Window Switch LH, Rear Safety Power Window Module LH, [LHD] Driver Safety Power Window Module, [RHD] Passenger Safety Power Window Module
MODULE6	⁶ 	10A	Surround View Monitor, Emergency Call (E-CALL) Module, IBU, Electronic ATM Shift Lever, A/V & Navigation Head Unit, AMP, Low DC-DC Converter (Audio/AMP), Overhead Console Lamp, Emergency Call Button, E/R Junction Block (RLY.5 - Power Outlet)
A/CON	A/C	10A	A/C Control Module, A/C Switch, PM Sensor (A/C), Diesel Junction Block (RLY.3/4 - PTC Heater Relay #3/#4)
MODULE4	⁴ 	10A	Head Lamp LH/RH, Auto Head Lamp Leveling Device Module

Engine compartment fuse panel (Engine room junction block)

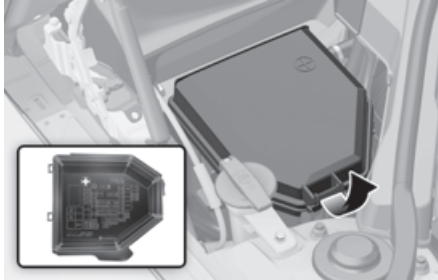

Inside the fuse/relay box cover, you can find the fuse/relay label describing fuse/relay names and ratings.

i Information

Not all fuse panel descriptions in this manual may be applicable to your vehicle; the information is accurate at the time of printing. When you inspect the fuse panel in your vehicle, refer to the fuse panel label.

Left-hand drive

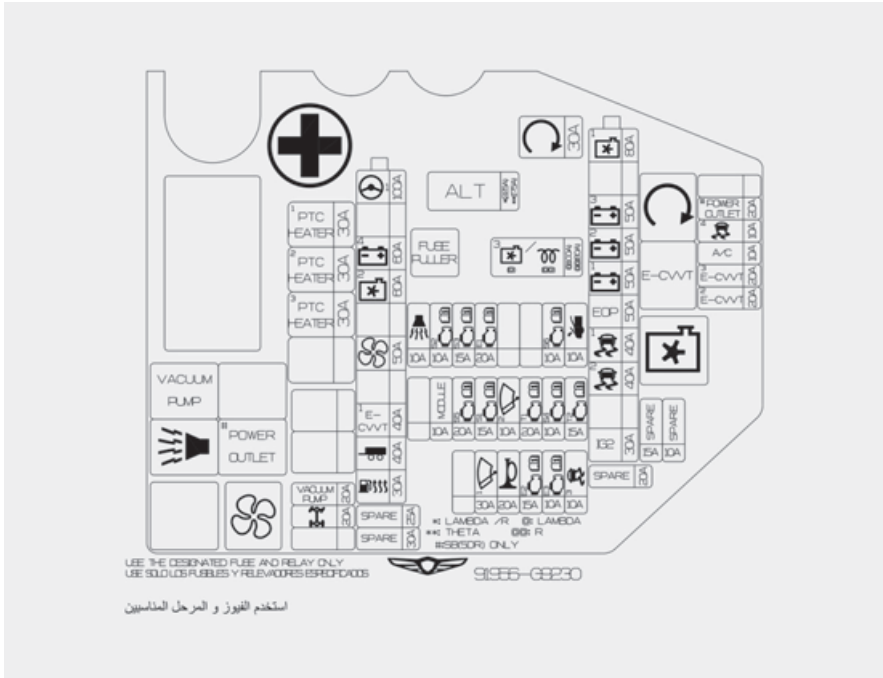



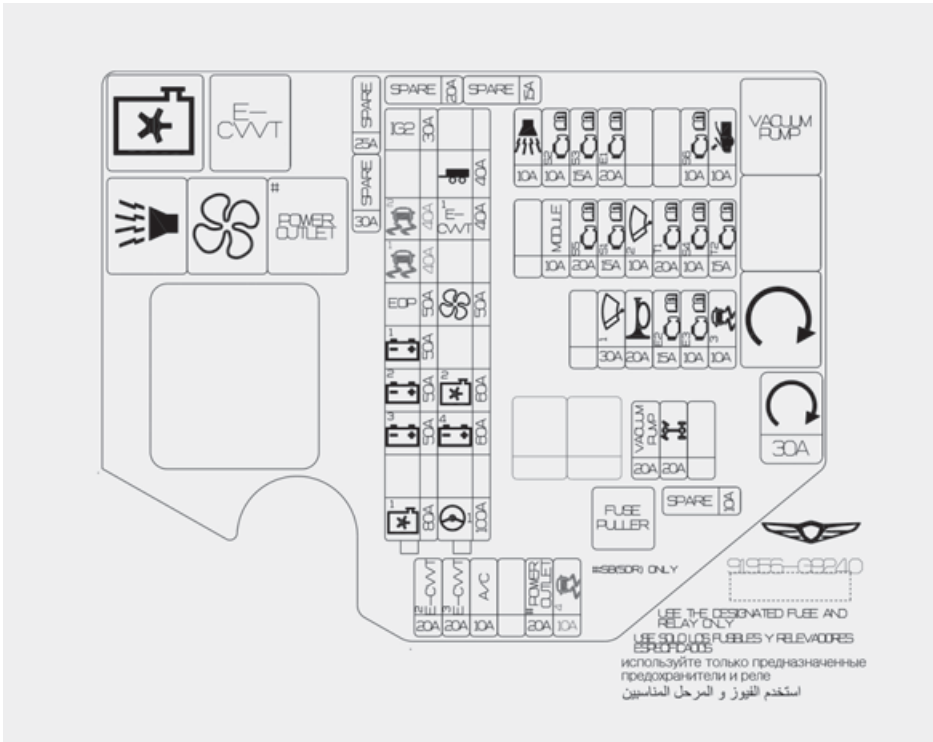













Right-hand drive



Engine compartment fuse panel (Engine compartment junction block)











- Left-hand drive



Fuse Name	Symbol	Fuse Rating	Circuit Protected
ALT	ALT	175A 225A	Alternator, Fuse - F2, Multi Fuse 1 - F4, F6, F7, F8, F9, F10, F11, F13
C/FAN3	³ 	125A	[G6DP - BLDC Motor] Cooling Fan Controller
GLOW			[D4HB] Glow Relay Unit
START		30A	RLY. 7 (Start Relay)
C/FAN1	¹ 	80A	[BLDC Motor] Cooling Fan Controller
B+3	³ 	50A	ICU Junction Block (Fuse - F4/F5, Long Term Load Latch Relay Fuse - F2/F11/F12/F13)
B+2	² 	50A	ICU Junction Block (Fuse - F27/F35/F43/F51/F52)
B+1	¹ 	50A	ICU Junction Block (Fuse - F28/F29/F37/F45/F53)
EOP	EOP	50A	[With ISG] Electric Oil Pump Module
ESP1	¹ 	40A	ESP Control Module
ESP2	² 	40A	ESP Control Module
IG2	IG2	30A	PCB Block (IG2 Relay)
MDPS	 ¹	100A	MDPS Unit
B+4	⁴ 	60A	PCB Block (Engine Control Relay, Fuse - F4, F5, F13, F22)

Fuse Name	Symbol	Fuse Rating	Circuit Protected
C/FAN2	² 	60A	[DC Motor] RLY. 9 (Cooling Fan Relay)
BLOWER		50A	RLY. 6 (Blower Relay)
E-CVVT1	¹ E-CVVT	40A	[G4KL] RLY. 8 (E-CVVT Relay)
TRAILER		40A	Trailer Connector
FUEL HEATER		30A	Diesel Junction Block (RLY.1 Fuel Filter Heater Relay)
PTC HEATER1	¹ PTC HEATER	30A	Diesel Junction Block (RLY.2 PTC Heater #1 Relay)
PTC HEATER2	² PTC HEATER	30A	Diesel Junction Block (RLY.3 PTC Heater #2 Relay)
PTC HEATER3	³ PTC HEATER	30A	Diesel Junction Block (RLY.4 PTC Heater #3 Relay)
VACUUM PUMP	VACUUM PUMP	20A	[G4KL/G6DP] RLY. 1 (Vacuum Pump Relay)
AWD		20A	AWD ECM
POWER OUTLET	# POWER OUTLET	20A	E/R Junction Block (RLY.5 - Power Outlet Relay)
ESP4	⁴ 	10A	ESP Control Module
A/CON	A/C	10A	A/C Control Module
E-CVVT3	³ E-CVVT	20A	[G4KL] ECM
E-CVVT2	² E-CVVT	20A	[G4KL] ECM















Engine compartment fuse panel (Engine compartment junction block)



- Right-hand drive

Fuse Name	Symbol	Fuse Rating	Circuit Protected
START		30A	RLY. 7 (Start Relay)
C/FAN1	¹ 	80A	[BLDC Motor] Cooling Fan Controller
B+3	³ 	50A	ICU Junction Block (Fuse - F4/F5, Long Term Load Latch Relay Fuse - F2/F11/F12/F13)
B+2	² 	50A	ICU Junction Block (Fuse - F27/F35/F43/F51/F52)
B+1	¹ 	50A	ICU Junction Block (Fuse - F28/F29/F37/F45/F53)
EOP	EOP	50A	[With ISG] Electric Oil Pump Module
ESP1	¹ 	40A	ESP Control Module
ESP2	² 	40A	ESP Control Module
IG2	IG2	30A	PCB Block (IG2 Relay)
MDPS	 ¹	100A	MDPS Unit
B+4	⁴ 	60A	PCB Block (Engine Control Relay, Fuse - F4/F5/F13/F22)
C/FAN2	² 	60A	[DC Motor] RLY. 9 (Cooling Fan Relay)
BLOWER		50A	RLY. 6 (Blower Relay)
E-CVVT1	¹ E-CVVT	40A	[G4KL] RLY. 8 (E-CVVT Relay)







Fuse Name	Symbol	Fuse Rating	Circuit Protected
TRAILER		40A	Trailer Connector
VACUUM PUMP	VACUUM PUMP	20A	[G4KL/G6DP] RLY. 1 (Vacuum Pump Relay)
AWD		20A	AWD ECM
POWER OUTLET	# POWER OUTLET	20A	E/R Junction Block (RLY.5 - Power Outlet Relay)
ESP4	⁴ 	10A	ESP Control Module
A/CON	A/C	10A	A/C Control Module
E-CVVT3	³ E-CVVT	20A	[G4KL] ECM
E-CVVT2	² E-CVVT	20A	[G4KL] ECM

Engine compartment fuse panel (PCB block)

Fuse Name	Symbol	Fuse Rating	Circuit Protected
ESC3		10A	ESP Control Module
ECU3		10A	ECM
ECU2		15A	ECM
HORN		20A	Horn Relay
WIPER1		30A	Wiper Power Relay
TCU2		15A	P/N Relay, TCM
SENSOR4		10A	Electronic Oil Pump Module, [G4KL/G6DP] Brake Vacuum Switch, E/R Junction Block (RLY.1 - Brake Vacuum Relay)
TCU1		20A	TCM
WIPER2		10A	IBU, ECM
SENSOR1		15A	Rear Sub Junction Block (Fuel Pump Relay), [D4HB] Rail Pressure Regulating Valve, Diesel Junction Block (RLY.1 Fuel Filter Heater Relay)
SENSOR5		20A	[G4KL] Ignition Coil #1/#2/#3/#4 [G6DP] Ignition Coil #1/#2/#3/#4/#5/#6 [D4HB] Electronic Water Pump
MODULE	MODULE	10A	E/R Junction Block (RLY.6 - Blower Relay)
ACTIVE HOOD		10A	Active Hood Lift Control Module
SENSOR6		10A	[D4HB] Glow Relay Unit, Fuel Heater & Water Separator Sensor
ECU1		20A	ECM
SENSOR3		15A	[G4KL] Oxygen Sensor (Up/Down) [G6DP] Oxygen Sensor #1/#2/#3/#4 [D4HB] Lambda Sensor #1/#2, Electronic VGT Actuator, Fuel Metering Unit, EGR Cooling Bypass Solenoid Valve, PTC Heater, Mid Nox Sensor, PM Sensor, Rear Nox Sensor

Fuse Name	Symbol	Fuse Rating	Circuit Protected
SENSOR2		10A	E/R Junction Block (RLY. 9 - Cooling Fan Relay), [G4KL] Electronic Thermostat, Oil Control Valve, Purge Control Solenoid Valve, Recirculation Control Solenoid Valve, Cooling Fan Controller [G6DP] Electronic Thermostat, Oil Pressure Solenoid Valve, Oil Control Valve #1/#2/#3/#4 (Intake/Exhaust), Recirculation Control Solenoid Valve, Purge Control Solenoid Valve, Cooling Fan Controller, Variable Exhaust Flap Actuator LH, Variable Exhaust Flap Actuator RH [D4HB] Oil Pump Solenoid Valve, Air Flow Sensor, Crankshaft Position Sensor, Front Nox Sensor, Oil Level Sensor, Stop Lamp Switch
B/ALARM		10A	E/R Junction Block (RLY. 2 - Burglar Alarm Horn Relay)

Relay

Type	Relay No.	Symbol	Relay Name
MICRO	RLY. 1		Vacuum Pump Relay
MICRO	RLY. 2		Burglar Alarm Horn Relay
MICRO	RLY. 5		Power Outlet Relay
MICRO	RLY. 6		Blower Relay
MICRO	RLY. 7		Start Relay
MICRO	RLY. 8		E-CVVT Relay (G4KL)
MINI	RLY. 9		Cooling Fan Relay

Trunk (or tailgate) fuse panel (Rear sub junction block)

Sedan



Shooting Brake







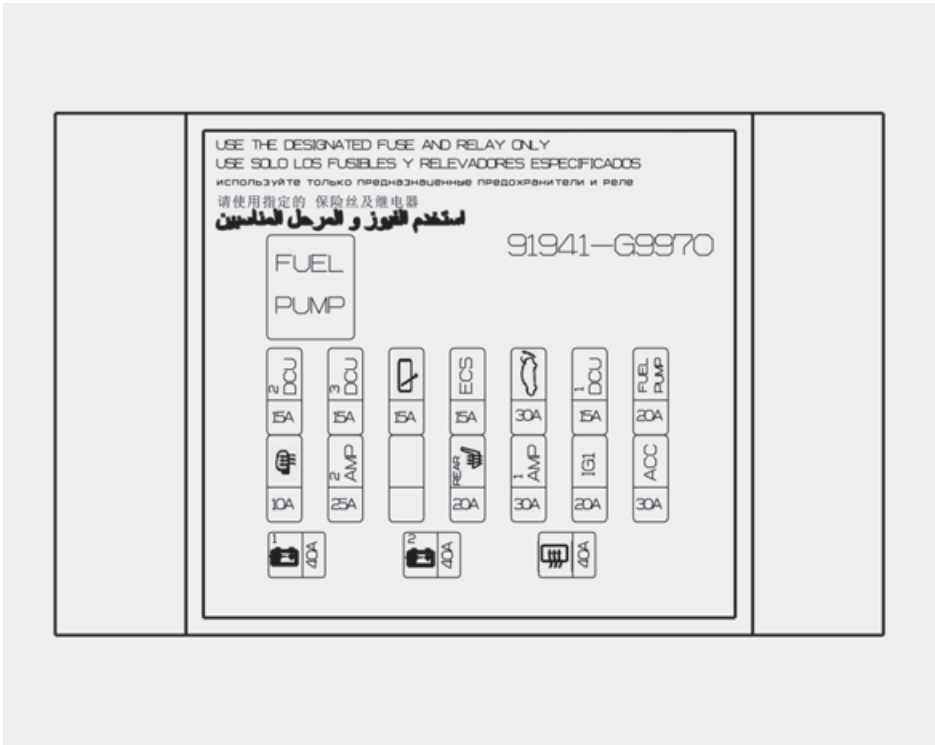

Inside the fuse/relay box cover, you can find the fuse/relay label describing fuse/relay names and ratings.

i Information

Not all fuse panel descriptions in this manual may be applicable to your vehicle; the information is accurate at the time of printing. When you inspect the fuse panel in your vehicle, refer to the fuse panel label.



Rear fuse box panel

Fuse Name	Symbol	Fuse Rating	Circuit Protected
DCU2	² DCU	15A	[D4HB] Dosing Control Module, Urea Pump (Shooting Brake)
DCU3	³ DCU	15A	[D4HB] Dosing Control Module, Urea Sensor (Shooting Brake)
REAR WIPER		15A	Wiper RR Relay, Rear Wiper Motor
ECS	ECS	15A	ECS Unit
POWER TRUNK		30A	Power Trunk Module, Power Tailgate Unit
DCU1	¹ DCU	15A	[D4HB] Dosing Control Module, Urea Pump (Shooting Brake)
FUEL PUMP	FUEL PUMP	20A	Fuel Pump Relay
HEATED MIRROR		10A	[W/O IMS] Driver/Passenger Power Outside Rearview Mirror
AMP2	² AMP	25A	AMP
REAR S/HEAT	^{REAR} 	20A	Rear Seat Warmer Control Module
AMP1	¹ AMP	30A	[W/O ISG] Fuse - F9 [With ISG] Low DC-DC Converter (AMP)
IG1	IG1	20A	IG1 Relay
ACC	ACC	30A	ICU Junction Block (Fuse - F32, F40, F48, F54)
B+1	¹ 	40A	ICU Junction Block (IPS6, IPS7, IPS8, IPS9, IPS10, Fuse - F20, F30)
B+2	² 	40A	ICU Junction Block (IPS1, IPS2, IPS3, IPS4, IPS5, Fuse - F15, F31, F39)
REAR HEATED		40A	Rear Heated Relay

Trunk (or tailgate) fuse panel (Battery junction block)

Sedan



Shooting Brake





Inside the fuse/relay box cover, you can find the fuse/relay label describing fuse/relay names and ratings.

***i* Information**

Not all fuse panel descriptions in this manual may be applicable to your vehicle; the information is accurate at the time of printing. When you inspect the fuse panel in your vehicle, refer to the fuse panel label.



Battery box fuse panel

Fuse Name	Symbol	Fuse Rating	Circuit Protected
B+1		100A	Rear Sub Junction Block (ACC Relay, Fuse - F7, F12, F13, F16, F17)
B+2		100A	Rear Sub Junction Block (DCU Relay, Fuse - F3, F5, F4, F11, F15)
START		40A	E/R Junction Block (Fuse - F3), PCB Block (Fuse - F3, F9)
AMS	AMS	10A	Battery Sensor

Light bulbs

We recommend that you consult an authorized retailer of Genesis Branded products to replace most vehicle light bulbs. It is difficult to replace vehicle light bulbs because other parts of the vehicle must be removed before you can get to the bulb. This is especially true for removing the headlight assembly to get to the bulb(s).

Removing/installing the headlight assembly can result in damage to the vehicle.

WARNING

- Prior to working on a light, depress the foot brake, shift to P (Park), apply the parking brake, press the Engine Start/Stop button to the OFF position and take the key with you when leaving the vehicle to avoid sudden movement of the vehicle and to prevent possible electric shock.
- Be aware the bulbs may be hot and may burn your fingers.

NOTICE

Be sure to replace the burned-out bulb with one of the same wattage to prevent damage to the fuse or electrical wiring system.

NOTICE

To prevent damage, do not clean the headlight lens with chemical solvents or strong detergents.

i Information

- Headlight desiccant (if equipped)

This vehicle is equipped with desiccant to reduce fogging inside the headlight due to moisture. The desiccant is consumable and its performance may change based on the used period or environment. If fogging inside the headlight due to moisture continues for a long time, we recommend that you consult an authorized retailer of Genesis Branded products.

i Information

The headlight and tail light lenses could appear frosty if the vehicle is washed after driving or the vehicle is driven at night in wet weather. This condition is caused by temperature difference between the light inside and outside and, it does not indicate a problem with your vehicle. When moisture condenses in the light, it will be removed after driving with the headlight on. The removable level may differ depending on light size, light position and environmental condition. However, if moisture is not removed, we recommend that your vehicle is inspected by an authorized retailer of Genesis Branded products.

i Information

- A normally functioning light may flicker momentarily to stabilize the vehicle's electrical control system. However, if the light goes out after flickering momentarily, or continues to flicker, we recommend the system be checked by an authorized retailer of Genesis Branded products.
- The position light may not turn on when the position light switch is turned on, but the position light and headlight switch may turn on when the headlight switch is turned on. This may be caused by network failure or vehicle electrical control system malfunction. If this occurs, we recommend the system be checked by an authorized retailer of Genesis Branded products.

i Information

The headlight aiming should be adjusted after an accident or after the headlight assembly is reinstalled.

i Information

Traffic Change

The low beam light distribution is asymmetric. If you go abroad to a country with opposite traffic direction, this asymmetric part will dazzle oncoming car driver. To prevent dazzle, ECE regulation demand several technical solutions (ex. automatic change system, adhesive sheet, down aiming). This headlights are designed not to dazzle opposite drivers. So, you need not change your headlights in a country with opposite traffic direction.

Headlight, Position light, Turn signal light, Daytime running light (DRL) replacement



- (1) Headlight (Low)
- (2) Headlight (High/Sub Low)
- (3) Position light/Daytime running light/Turn signal light

If the LED light does not operate, we recommend that the system be inspected by an authorized retailer of Genesis Branded products.

The LED lights cannot be replaced as a single unit because it is an integrated unit. The LED lights has to be replaced with the unit.

A skilled technician should check or repair the LED light, for it may damage related parts of the vehicle.

Headlight aiming



- (1) Low beam and high beam vertical aiming
 - (2) Low beam and high beam horizontal aiming
1. Inflate the tires to the specified pressure and remove any loads from the vehicle except the driver, spare tire, and tools.
 2. The vehicle should be placed on a flat floor.
 3. Draw vertical lines (Vertical lines passing through respective head light centers) and a horizontal line (Horizontal line passing through center of head lights) on the screen.
 4. With the headlight and battery in normal condition, aim the headlights so the brightest portion falls on the horizontal and vertical lines.
 5. To aim the low beam and high beam left or right, turn the driver clockwise or counterclockwise.

To aim the low beam and high beam up or down, turn the driver clockwise or counterclockwise.

Aiming point

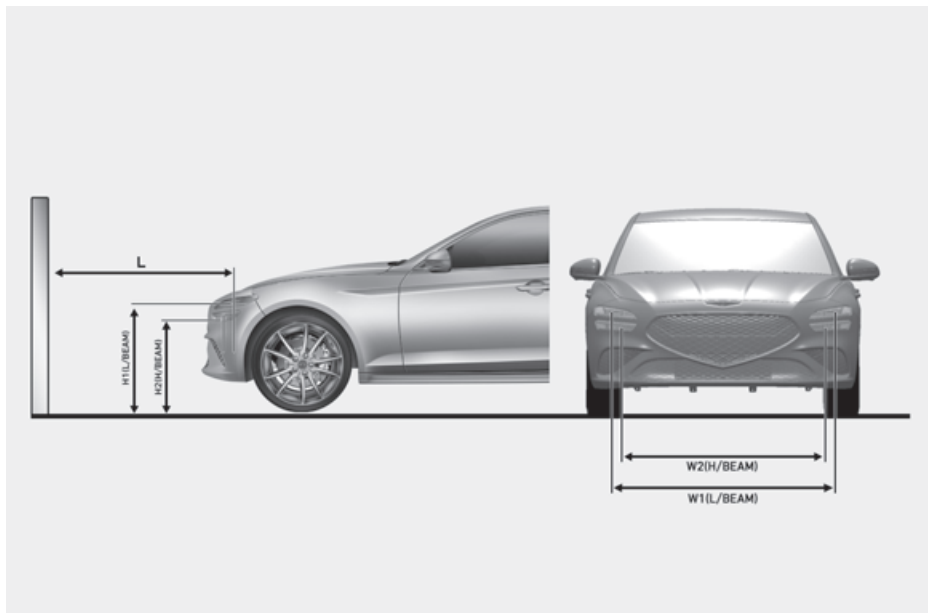

H1 : Height between the head lamp bulb center and ground (Low beam)

H2 : Height between the head lamp bulb center and ground (High beam)

W1 : Distance between the two head lamp bulbs centers (Low beam)

W2 : Distance between the two head lamp bulbs centers (High beam)

Vehicle condition		H1	H2	W1	W2
Without driver mm (in)	Except Russia	682 (26.9)	582 (22.9)	1464 (57.6)	1450 (57.1)
	For Russia	702 (27.6)	602 (23.7)	1464 (57.6)	1450 (57.1)
With driver mm (in)	Except Russia	677 (36.7)	577 (22.7)	1464 (57.6)	1450 (57.1)
	For Russia	697 (27.4)	597 (23.5)	1464 (57.6)	1450 (57.1)

Headlight beam

Based on 10m screen

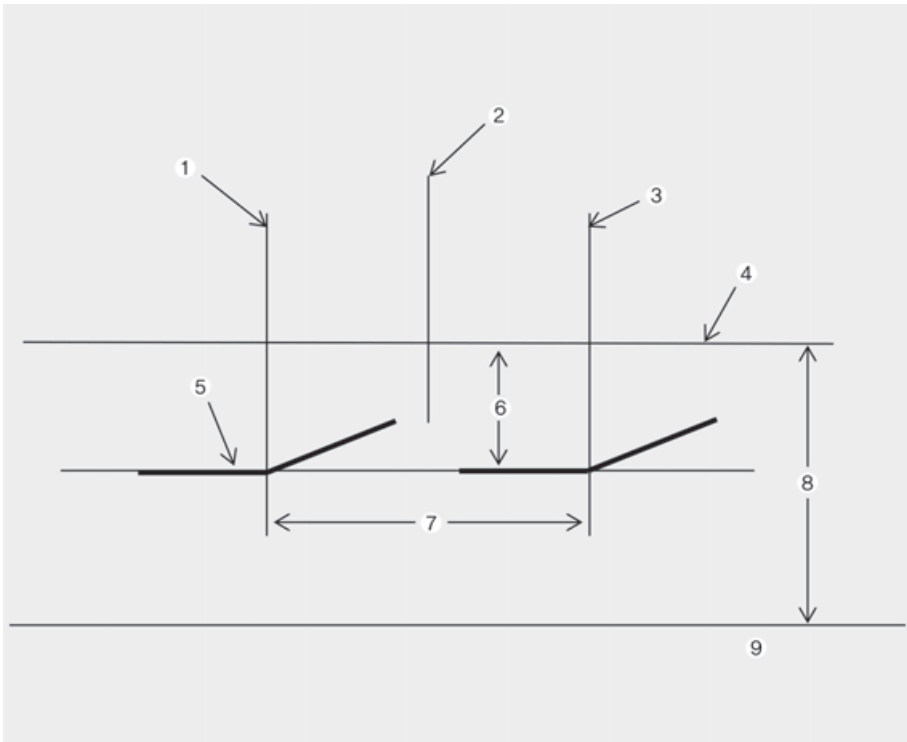

- (1) Vertical line of the left headlight bulb center
- (2) Car axis
- (3) Vertical line of the right headlight bulb center
- (4) Horizontal line of headlight bulb center
- (5) Cut-off line
- (6) 100
- (7) W1 (Low beam)
- (8) H1 (Low beam)
- (9) Ground

1. Turn the low beam on without driver aboard.
2. The cut-off line should be projected in the cut-off line shown in the picture.
3. When aiming the low beam, vertical aiming should be adjusted after adjusting the horizontal aiming.
4. If headlight leveling device is equipped, adjust the head light leveling device switch to "0".

i Information

The high beam is aimed simultaneously when aiming the low beam.

Side repeater light replacement



If the LED light (1) does not operate, we recommend that the system be inspected by an authorized retailer of Genesis Branded products.

The LED lights cannot be replaced as a single unit because it is an integrated unit. The LED lights has to be replaced with the unit.

A skilled technician should check or repair the LED light, for it may damage related parts of the vehicle.

Puddle light replacement

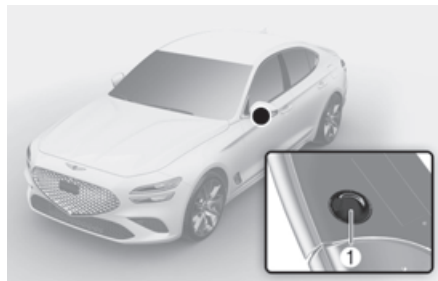

If the LED light (1) does not operate, we recommend that the system be inspected by an authorized retailer of Genesis Branded products.

The LED lights cannot be replaced as a single unit because it is an integrated unit. The LED lights has to be replaced with the unit.

A skilled technician should check or repair the LED light, for it may damage related parts of the vehicle.

Rear combination light replacement

Sedan

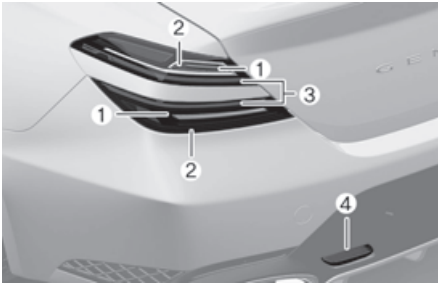

Shooting Brake

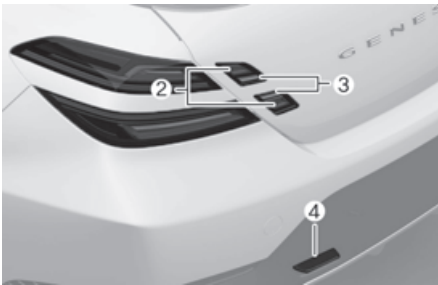

- (1) Stop light
- (2) Stop/Tail light
- (3) Turn signal light
- (4) Back up light

If the LED light does not operate, we recommend that the system be inspected by an authorized retailer of Genesis Branded products.

The LED lights cannot be replaced as a single unit because it is an integrated unit. The LED lights has to be replaced with the unit.

A skilled technician should check or repair the LED light, for it may damage related parts of the vehicle.

Rear fog light replacement

+ If equipped

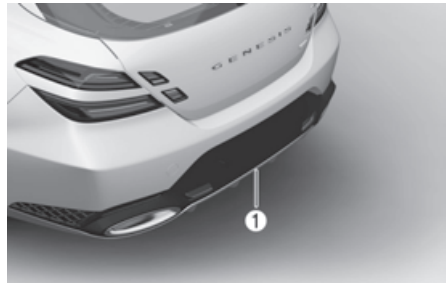

Sedan

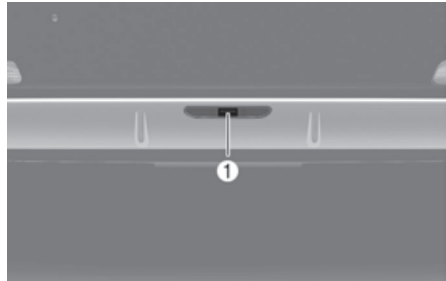

Shooting Brake



If the LED light (1) does not operate, we recommend that the system be inspected by an authorized retailer of Genesis Branded products.

The LED lights cannot be replaced as a single unit because it is an integrated unit. The LED lights has to be replaced with the unit.

A skilled technician should check or repair the LED light, for it may damage related parts of the vehicle.

High mounted stop light replacement

Sedan



Shooting Brake



If the LED light (1) does not operate, we recommend that the system be inspected by an authorized retailer of Genesis Branded products.

The LED lights cannot be replaced as a single unit because it is an integrated unit. The LED lights has to be replaced with the unit.

A skilled technician should check or repair the LED light, for it may damage related parts of the vehicle.

License plate light replacement

Sedan



Shooting Brake

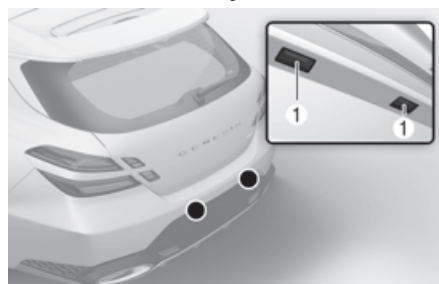

If the LED light (1) does not operate, we recommend that the system be inspected by an authorized retailer of Genesis Branded products.

The LED lights cannot be replaced as a single unit because it is an integrated unit. The LED lights has to be replaced with the unit.

A skilled technician should check or repair the LED light, for it may damage related parts of the vehicle.

Interior light replacement

Front lamps



Rear lamps



Vanity mirror lamp

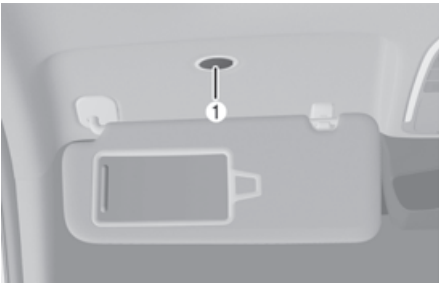

Glove box lamp

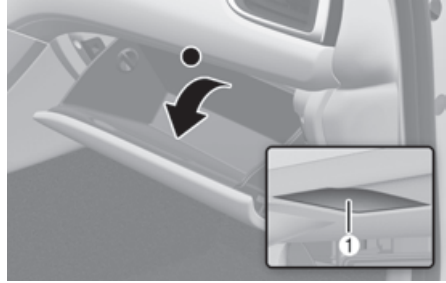

Mood lamp



Foot lamp

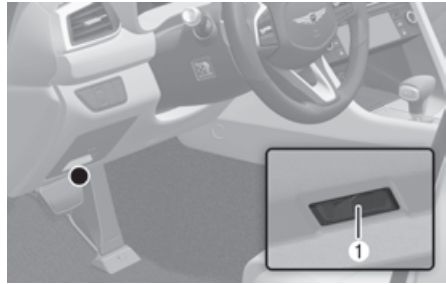

Trunk lamp (Sedan)



Tailgate lamp (Shooting Brake)



If the LED light does not operate, we recommend that the system be inspected by an authorized retailer of Genesis Branded products.

The LED lights cannot be replaced as a single unit because it is an integrated unit. The LED lights has to be replaced with the unit.

A skilled technician should check or repair the LED light, for it may damage related parts of the vehicle.

Appearance care

Exterior care

NOTICE

If you park your vehicle near a stainless steel sign or glass facade building, the vehicle's exterior plastic parts such as a bumper, spoiler, garnish, lamp or outside rearview mirror might be damaged due to sunlight reflected from the sign or building. To prevent damage of the exterior plastic parts, you should avoid parking in areas where light may be reflected or use a car cover. (The exterior plastic parts applied to your vehicle may vary.)

Exterior general caution

It is very important to follow the label directions when using any chemical cleaner or polish. Read all warning and caution statements that appear on the label.

Finish maintenance

Washing

To help protect your vehicle's finish from rust and deterioration, wash it thoroughly and frequently at least once a month with lukewarm or cold water.

If you use your vehicle for off-road driving, you should wash it after each off-road trip. Pay special attention to the removal of any accumulation of salt, dirt, mud, and other foreign materials. Make sure the drain holes in the lower edges of the doors and rocker panels are kept clear and clean.

Insects, tar, tree sap, bird droppings, industrial pollution and similar deposits can damage your vehicle's finish if not removed immediately.

Even prompt washing with plain water may not completely remove all these deposits. A mild soap, safe for use on painted surfaces, should be used.

After washing, rinse the vehicle thoroughly with lukewarm or cold water. Do not allow soap to dry on the finish.

High-pressure washing

- When using high-pressure washers, make sure to maintain sufficient distance from the vehicle. Insufficient clearance or excessive pressure can lead to component damage or water penetration.
- Do not spray the camera, sensors or its surrounding area directly with a high pressure washer. Shock applied from high pressure water may cause the device to not operate normally.
- Do not bring the nozzle tip close to boots (rubber or plastic covers) or connectors as they may be damaged if they come into contact with high pressure water.
- Do not remove snow or ice using high pressure washing.
- Noise may occur when operating the window after washing. We recommend operating the window after removing moisture from the rubber parts around the window.

WARNING

After washing the vehicle, test the brakes while driving slowly to see if they have been affected by water before getting on the road. If braking performance is impaired, dry the brakes by applying them lightly while maintaining a slow forward speed.

NOTICE

- Do not use strong soap, chemical detergents or hot water, and do not wash the vehicle in direct sunlight or when the body of the vehicle is warm.
 - Be careful when washing the side windows of your vehicle.
 - Especially, with high-pressure water, water may leak through the windows and wet the interior.
 - To prevent damage to the plastic parts, do not clean with chemical solvents or strong detergents.
-

NOTICE



- Water washing in the engine compartment including high pressure water washing may cause the failure of electrical circuits located in the engine compartment.
 - Never allow water or other liquids to come in contact with electrical/electronic components inside the vehicle as this may damage them.
-

NOTICE

Matte paint finish vehicle (if equipped)
Automatic car wash which uses rotating brushes should not be used as this can damage the surface of your vehicle. A steam cleaner which washes the vehicle surface at high temperature may result the oil to adhere and leave stains that is difficult to remove.

Use a soft cloth (e.g. microfiber towel or sponge) when washing your vehicle and dry with a microfiber towel. When you hand wash your vehicle, you should not use a cleaner that finishes with wax. If the vehicle surface is too dirty (sand, dirt, dust, contaminant, etc.), clean the surface with water before washing the car.

Waxing

A good coat of wax is a barrier between your paint and contaminate. Keeping a good coat of wax on your vehicle will help protect it.

Wax the vehicle when water will no longer bead on the paint.

Always wash and dry the vehicle before waxing. Use a good quality liquid or paste wax, and follow the manufacturer's instructions. Wax all metal trim to protect it and to maintain its luster.

Removing oil, tar, and similar materials with a spot remover will usually strip the wax from the finish. Be sure to re-wax these areas even if the rest of the vehicle does not yet need waxing.

NOTICE

- Wiping dust or dirt off the body with a dry cloth will scratch the finish.
 - Do not use steel wool, abrasive cleaners, or strong detergents containing highly alkaline or caustic agents on chrome-plated or anodized aluminum parts. This may result in damage to the protective coating and cause discoloration or paint deterioration.
-

NOTICE

Matte paint finish vehicle (if equipped)
Do not use any polish protector such as a detergent, an abrasive and a polish. In case wax is applied, remove the wax immediately using a silicon remover and if any tar or tar contaminant is on the surface use a tar remover to clean. However, be careful not to apply too much pressure on the painted area.

Finish damage repair

Deep scratches or stone chips in the painted surface must be repaired promptly. Exposed metal will quickly rust and may develop into a major repair expense.

NOTICE

If your vehicle is damaged and requires any metal repair or replacement, be sure the body shop applies anti-corrosion materials to the parts repaired or replaced.

NOTICE

Matte paint finish vehicle (if equipped)

In case of matte paint finish vehicles, it is impossible to modify only the damaged area and repair of the whole part is necessary. If the vehicle is damaged and painting is required, we recommend that you have your vehicle maintained and repaired by an authorized retailer of Genesis Branded products. Take extreme care, as it is difficult to restore the quality after the repair.

Bright-metal maintenance

- To remove road tar and insects, use a tar remover, not a scraper or other sharp object.
- To protect the surfaces of bright metal parts from corrosion, apply a coating of wax or chrome preservative and rub to a high luster.
- During winter weather or in coastal areas, cover the bright metal parts with a heavier coating of wax or preservative. If necessary, coat the parts with non-corrosive petroleum jelly or other protective compound.

Underbody maintenance

Corrosive materials used for ice and snow removal and dust control may collect on the underbody. If these materials are not removed, accelerated rusting can occur on underbody parts such as the fuel lines, frame, floor pan and exhaust system, even though they have been treated with rust protection.

Thoroughly flush the vehicle underbody and wheel openings with lukewarm or cold water once a month, after off-road driving and at the end of each winter. Pay special attention to these areas because it is difficult to see all the mud and dirt. It will do more harm than good to wet down the road grime without removing it. The lower edges of doors, rocker panels, and frame members have drain holes that should not be allowed to clog with dirt; trapped water in these areas can cause rusting.

⚠ WARNING

After washing the vehicle, test the brakes while driving slowly to see if they have been affected by water. If braking performance is impaired, dry the brakes by applying them lightly while maintaining a slow forward speed.

Aluminum wheel maintenance

The aluminum wheels are coated with a clear protective finish.

- Do not use abrasive cleaner, polishing compound, solvent, or wire brushes on aluminum wheels.
- Clean the wheel when it has cooled.
- Use only a mild soap or neutral detergent, and rinse thoroughly with water. Also, clean the wheels after driving on salted roads.
- Do not wash the wheels with high-speed car wash brushes.
- Do not use any cleaners containing acid or alkaline detergents.

Corrosion protection**Protecting your vehicle from corrosion**

By using the most advanced design and construction practices to combat corrosion, Genesis Branded Vehicle produces vehicles of the highest quality. However, this is only part of the job. To achieve the long-term corrosion resistance your vehicle can deliver, the owner's cooperation and assistance is also required.

Common causes of corrosion

The most common causes of corrosion on your vehicle are:

- Road salt, dirt and moisture that is allowed to accumulate underneath the vehicle.
- Removal of paint or protective coatings by stones, gravel, abrasion or minor scrapes and dents which leave unprotected metal exposed to corrosion.

High-corrosion areas

If you live in an area where your vehicle is regularly exposed to corrosive materials, corrosion protection is particularly important. Some of the common causes of accelerated corrosion are road salts, dust control chemicals, ocean air and industrial pollution.

Moisture breeds corrosion

Moisture creates the conditions in which corrosion is most likely to occur. For example, corrosion is accelerated by high humidity, particularly when temperatures are just above freezing. In such conditions, the corrosive material is kept in contact with the vehicle surfaces by moisture that is slow to evaporate.

Mud is particularly corrosive because it is slow to dry and holds moisture in contact with the vehicle. Although the mud appears to be dry, it can still retain moisture and promote corrosion.

High temperatures can also accelerate corrosion of parts that are not properly ventilated so the moisture can be dispersed. For all these reasons, it is particularly important to keep your vehicle clean and free of mud or accumulations of other materials. This applies not only to the visible surfaces but particularly to the underside of the vehicle.

To help prevent corrosion

Keep your vehicle clean

The best way to prevent corrosion is to keep your vehicle clean and free of corrosive materials. Attention to the underside of the vehicle is particularly important.

- If you live in a high-corrosion area - where road salts are used, near the ocean, areas with industrial pollution, acid rain, etc.-, you should take extra care to prevent corrosion. In winter, hose off the underside of your vehicle at least once a month and be sure to clean the underside thoroughly when winter is over.
- When cleaning underneath the vehicle, pay particular attention to the components under the fenders and other areas that are hidden from view. Do a thorough job; just dampening the accumulated mud rather than washing it away will accelerate corrosion rather than prevent it. Water under high pressure and steam are particularly effective in removing accumulated mud and corrosive materials.
- When cleaning lower door panels, rocker panels and frame members, be sure that drain holes are kept open so that moisture can escape and not be trapped inside to accelerate corrosion.

Keep your garage dry

Don't park your vehicle in a damp, poorly ventilated garage. This creates a favorable environment for corrosion. This is particularly true if you wash your vehicle in the garage or drive it into the garage when it is still wet or covered with snow, ice or mud. Even a heated garage can contribute to corrosion unless it is well ventilated so moisture is dispersed.

Keep paint and trim in good condition

Scratches or chips in the finish should be covered with "touch-up" paint as soon as possible to reduce the possibility of corrosion. If bare metal is showing through, the attention of a qualified body and paint shop is recommended.

Bird droppings are highly corrosive and may damage painted surfaces in just a few hours. Always remove bird droppings as soon as possible.

Interior care

Interior general precautions

Prevent caustic solutions such as perfume and cosmetic oil, from contacting the interior parts because they may cause damage or discoloration. If they do contact the interior parts, wipe them off immediately. See the instructions for the proper way to clean vehicle interior surfaces.

NOTICE

- Never allow water or other liquids to come in contact with electrical/electronic components inside the vehicle as this may damage them.
- When cleaning leather products (steering wheel, seats etc.), use neutral detergents or low alcohol content solutions. If you use high alcohol content solutions or acid/alkaline detergents, the color of the leather may fade or the surface may get stripped off.

Cleaning the upholstery and interior trim

Vehicle interior surfaces

Remove dust and loose dirt from interior surfaces with a whisk broom or a vacuum cleaner.

If necessary, clean interior surfaces with a mixture of warm water and mild non-detergent cleaner (test all cleaners on a concealed area before use).

Fabric

Remove dust and loose dirt from fabric with a whisk broom or vacuum cleaner. Clean with a mild soap solution recommended for upholstery or carpets. Remove fresh spots immediately with a fabric spot cleaner. If fresh spots do not receive immediate attention, the fabric can be stained and its color can be affected. Also, its fire-resistant properties can be reduced if the material is not properly maintained.

NOTICE

Using anything but recommended cleaners and procedures may affect the fabric's appearance and fire-resistant properties.

Leather

- Features of seat leather
 - Leather is made from the outer skin of an animal, which goes through a special process to be available for use. Since it is a natural product, each part differs in thickness or density. Wrinkles may appear as a natural result of stretching and shrinking depending on the temperature and humidity.
 - The seat is made of stretchable fabric to improve comfort.
 - The parts contacting the body are curved and the side supporting area is high which provides driving comfort and stability.
 - Wrinkles may appear naturally from usage. It is not a fault of the products.

NOTICE

- Wrinkles or abrasions which appear naturally from usage are not covered by warranty.
 - Belts with metallic accessories, zippers or keys inside the back pocket may damage the seat fabric.
 - Make sure not to wet the seat. It may change the nature of natural leather.
 - Jeans or clothes which could bleach may contaminate the surface of the seat covering fabric.
-

- Caring for the leather seats
 - Vacuum the seat periodically to remove dust and sand on the seat. It will prevent abrasion or damage of the leather and maintain its quality.
 - Wipe the natural leather seat cover often with dry or soft cloth.
 - Use of proper leather protector may prevent abrasion of the cover and helps maintain the color. Be sure to read the instructions and consult a specialist when using leather coating or protective agent.
 - Light colored (beige, cream beige) leather is easily contaminated and the stain is noticeable. Clean the seats frequently.
 - Avoid wiping with wet cloth. It may cause the surface to crack.

- Cleaning the leather seats

- Remove all contaminations instantly. Refer to the instructions below for removal of each contaminant.
- Cosmetic products (sunscreen, foundation, etc.)

Apply cleansing cream on a cloth and wipe the contaminated spot. Wipe off the cream with a wet cloth and remove water with a dry cloth.

- Beverages (coffee, soft drink, etc.)

Apply a small amount of neutral detergent and wipe until contaminations do not smear.

- Oil

Remove oil instantly with absorbable cloth and wipe with stain remover used only for natural leather.

- Chewing gum

Harden the gum with ice and remove gradually.

- Handling prime napa leather

Try to avoid excessive sunlight and heat exposure. Excessive sunlight and heat exposure naturally fades and dries out napa leather, causing wrinkles and discoloration. If the napa leather is wet with liquid, immediately clean it with lint-free cloth to minimize damage. Do not scratch the napa leather surface with a sharp object. If your napa leather seat is bright colored, it may be contaminated or stained from dyed materials such as jeans.

Interior wooden trim

- Use a wooden furniture protector (for example, wax, coating compound) to clean the interior wooden trim.
- Often wipe the interior wooden trim with a lint-free, clean cloth to maintain the unique wooden textures for a longer period of time.
- If you spill beverage (for example, water, coffee) over the interior wooden trim, immediately wipe it with clean, dry cloth.
- Sharp objects (for example, driver, knife), adhesive materials, or tapes may damage the interior wooden trim.
- Any strong impacts may damage the interior wooden trim.
- If the coating finish over the interior wooden trim is removed, moisture may damage or change wood traits.
- If the interior wooden trim is damaged, you may get a splinter from the wood surface. Therefore, you should immediately have replaced the damaged interior wooden trim. We recommend that you contact an authorized Retailer of Genesis Branded Products.

Cleaning the seat belt webbing

Clean the belt webbing with any mild soap solution recommended for cleaning upholstery or carpet. Follow the instructions provided with the soap. Do not bleach or re-dye the webbing because this may weaken the seat belt.

Cleaning the interior window glass

If the interior glass surfaces of the vehicle become fogged (that is, covered with an oily, greasy or waxy film), they should be cleaned with glass cleaner. Follow the directions on the glass cleaner container.

NOTICE

Do not scrape or scratch the inside of the rear window. This may result in damage to the rear window defroster grid.

Emission control system

The emission control system of your vehicle is covered by a written limited warranty. Please see the warranty information contained in the Service Passport in your vehicle.

Your vehicle is equipped with an emission control system to meet all applicable emission regulations. There are three emission control systems, as follows.

- Crankcase emission control system
- Evaporative emission control system
- Exhaust emission control system

In order to ensure the proper function of the emission control systems, it is recommended that you have your vehicle inspected and maintained by an authorized retailer of Genesis Branded products in accordance with the maintenance schedule in this manual.

NOTICE

For the Inspection and Maintenance Test (with Electronic Stability Control (ESC) system)

- To prevent the vehicle from misfiring during dynamometer testing, turn the Electronic Stability Control (ESC) system off by pressing the ESC switch (ESC OFF light illuminated).
 - After dynamometer testing is completed, turn the ESC system back on by pressing the ESC switch again.
-

Crankcase emission control system

The positive crankcase ventilation system is employed to prevent air pollution caused by blow-by gases being emitted from the crankcase. This system supplies fresh filtered air to the crankcase through the air intake hose. Inside the crankcase, the fresh air mixes with blow-by gases, which then pass through the PCV valve into the induction system.

Evaporative emission control system

The Evaporative Emission Control System is designed to prevent fuel vapors from escaping into the atmosphere.

Canister

Fuel vapors generated inside the fuel tank are absorbed and stored in the onboard canister. When the engine is running, the fuel vapors absorbed in the canister are drawn into the surge tank through the purge control solenoid valve.

Purge Control Solenoid Valve (PCSV)

The purge control solenoid valve is controlled by the Engine Control Module (ECM); when the engine coolant temperature is low during idling, the PCSV closes so that evaporated fuel is not taken into the engine. After the engine warms-up during ordinary driving, the PCSV opens to introduce evaporated fuel to the engine.

Exhaust emission control system

The Exhaust Emission Control System is a highly effective system which controls exhaust emissions while maintaining good vehicle performance.

When the engine starts or fails to start, excessive attempts to restart the engine may cause damage to the emission system.

Engine exhaust (carbon monoxide) precautions

- Carbon monoxide can be present with other exhaust fumes. If you smell exhaust fumes of any kind in your vehicle, drive with all the windows fully open. Have your vehicle checked and repaired immediately.

WARNING

Engine exhaust gases contain carbon monoxide (CO). Though colorless and odorless, it is dangerous and could be lethal if inhaled. Follow the instructions on this page to avoid CO poisoning.

- Do not operate the engine in confined or closed areas (such as garages) any more than what is necessary to move the vehicle in or out of the area.
- When the vehicle is stopped in an open area for more than a short time with the engine running, adjust the ventilation system (as needed) to draw outside air into the vehicle.
- Never sit in a parked or stopped vehicle for any extended time with the engine running.
- When the engine stalls or fails to start, excessive attempts to restart the engine may cause damage to the emission control system.

Operating precautions for catalytic converters

WARNING

The exhaust system and catalytic converter are very hot during and immediately after the engine has been running. To avoid SERIOUS INJURY or DEATH:

- Do not park, idle, or drive the vehicle over or near flammable objects, such as grass, vegetation, paper, leaves, etc. A hot exhaust system can ignite flammable items under your vehicle.
- Keep away from the exhaust system and catalytic converter or you may get burned.

Also, do not remove the heat sink around the exhaust system, do not seal the bottom of the vehicle, and do not coat the vehicle for corrosion control. It may present a fire risk under certain conditions.

Your vehicle is equipped with a catalytic converter emission control device. To prevent damage to the catalytic converter and to your vehicle, take the following precautions:

- Use only UNLEADED FUEL for gasoline engines.
- Do not operate the vehicle when there are signs of engine malfunction, such as misfire or a noticeable loss of performance.
- Do not misuse or abuse the engine. Examples of misuse are coasting with the engine off and descending steep grades in gear with the engine off.
- Do not operate the engine at high idle speed for extended periods (5 minutes or more).

- Do not modify or tamper with any part of the engine or emission control system. We recommend that all inspections and adjustments must be made by an authorized retailer of Genesis Branded products.
- Avoid driving with an extremely low fuel level.

Running out of fuel could cause the engine to misfire, damaging the catalytic converter.

Gasoline Particulate Filter (GPF)

 if equipped

Gasoline Particulate Filter (GPF) system removes the soot in the exhaust gas.

The GPF system automatically burns (or oxidizes) the accumulated soot in accordance with driving situations, unlike a disposable air filter.

In other words, the accumulated soot is automatically purged out by the engine control system and by the high exhaust-gas temperature at normal/high driving speeds.

However, when the vehicle is continually driven at repeated short distances or driven at low speed for a long time, the accumulated soot may not be automatically removed because of low exhaust gas temperature. In this case, the accumulated soot may reach a certain amount regardless of the soot oxidization process, then the GPF lamp () will illuminate.

The Gasoline Particulate Filter (GPF) lamp stops illuminating, when the driving speed exceeds 80 km/h (50 mph) with engine rpm 1,500 - 4,000 and the gear in the 3rd position or above for about 30 minutes.

When the GPF lamp starts to blink or the warning message “Check exhaust system” pops up even though the vehicle was driven as mentioned above, we recommend that you have the GPF system checked by an authorized retailer of Genesis Branded products.

With GPF lamp blinking for an extended period of time, it may damage the GPF system and lower the fuel economy.

CAUTION

We recommend you to use only the regulated gasoline fuels, when your vehicle is equipped with the GPF system. When you use other gasoline fuels which contain unspecified additives, they may damage the GPF system and cause exhaust emission problems.

Diesel Particulate Filter (DPF)

 if equipped

Diesel Particulate Filter (DPF) system removes the soot in the exhaust gas.

The DPF system automatically burns (or oxidizes) the accumulated soot in accordance with driving situations, unlike a disposable air filter. In other words, the accumulated soot is automatically purged out by the engine control system and by the high exhaust-gas temperature at normal/high driving speeds.

However, when the vehicle is continually driven at repeated short distances or driven at low speed for a long time, the accumulated soot may not be automatically removed because of low exhaust gas temperature.

If this occurs, the accumulated soot is out of the detection range, the soot oxidization process does not occur, and the Diesel Particulate Filter (DPF) lamp () illuminates.

The Diesel Particulate Filter (DPF) lamp stops illuminating, when the driving speed exceeds 60 km/h (37 mph), or when the engine rpm is between 1,500 and 2,500 with the gear in the 2nd position or above for about 25 minutes.

When the DPF lamp continuously blinks or the warning message “Check exhaust system” pops up even though the vehicle was driven as mentioned above, we recommend that you have the DPF system checked by an authorized retailer of Genesis Branded products.

When the vehicle is continuously driven with the DPF lamp blinking for an extended period of time, it may damage the DPF system and lower the fuel economy.

CAUTION

We recommend you to use only the regulated diesel fuels, when your vehicle is equipped with the DPF system.

When you use other diesel fuels which are high in sulfurs (above 50 ppm) or that contain unspecified additives, they may damage the DPF system and cause white smoke emissions.

Lean NOx Trap (for diesel engine)

If equipped

Lean NOx Trap (LNT) system removes nitrogen oxide from the exhaust gas. A smell can occur in the exhaust gas depending on the quality of the fuel, and it can degrade NOx reduction performance. Please use regulated automotive diesel fuel.

Selective Catalytic Reduction (SCR) (for diesel engine)

Selective Catalytic Reduction system catalytically converts NOx to nitrogen and water by using reduction agent, urea solution.

DEF level/Urea level

Type A

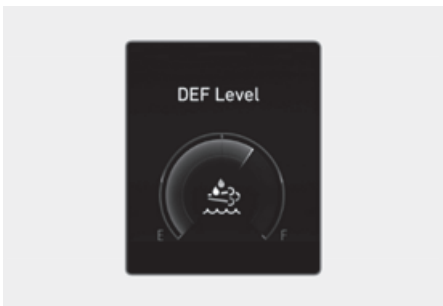

Type B

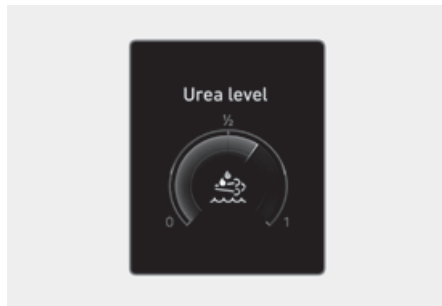

Type C



Type D



DEF (Diesel Exhaust Fluid) level gauge display shows the approximate amount of remaining urea solution inside the urea solution tank.

You can check the DEF level in the Utility view on the cluster.

Refer to the “Cluster display (Type A), Cluster display (Type B)” section in chapter 4.

Low urea warning message

Warning message will appear in four steps on the cluster according to urea solution level in the tank.

First warning

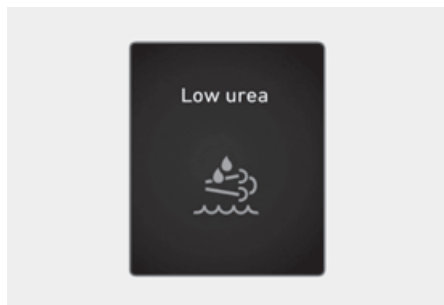

The SCR () warning light and "**Low urea**" warning message appears on the instrument cluster when urea level is low. Refill as soon as possible.

Second warning

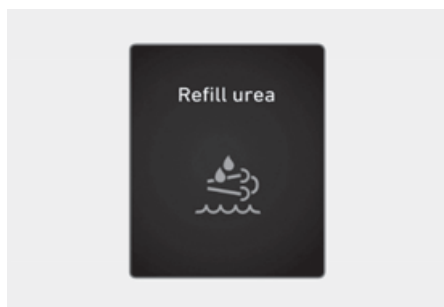

If urea is not refilled after the first warning, the SCR () warning light and "**Refill urea**" warning message appears on the instrument cluster when urea level is low. Refill as soon as possible.

Third warning

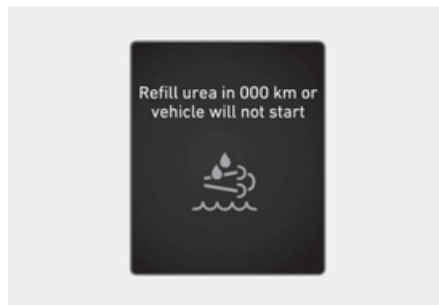

The SCR () warning light and "**Refill urea in 000 km or vehicle will not start/Refill urea in 000 km. Otherwise vehicle will not start**" warning message appears on the instrument cluster when urea solution tank is nearly empty. Refill immediately.

The displayed driving distance (000 km) and actual driving distance may vary depending on driving habits and driving conditions.

Fourth warning



The SCR () warning light and "**Refill urea tank or vehicle will not start/Refill urea tank. Otherwise vehicle will not start**" warning message appears on the instrument cluster when urea solution tank is empty. The vehicle cannot be restarted once the engine is turned off. Refill immediately.

Selective Catalytic Reduction system malfunction

When there is a problem with the Selective Catalytic Reduction system such as disconnected electrical components, use of incorrect urea, etc. the following warning message will appear on the instrument cluster. If this occurs, we recommend that the system be inspected by an authorized retailer of Genesis Branded products.

If you continue to drive without the problem solved, it may adversely effect system performance or the vehicle cannot be restarted once the engine is turned off.

	Malfunction	Driving 50 km after malfunction
Urea system failure (= no urea injection)	Diesel Exhaust Fluid (DEF) system failure/Urea dosing system error	Check urea system
Incorrect urea detected (= abnormal urea)	Incorrect urea detected	Refill with correct urea in 000 km or vehicle will not start/Refill correct urea in 000 km. Otherwise vehicle will not start
Abnormal urea consumption (= post treatment failure)	Check urea system	Service urea system in 000 km or vehicle will not start/Service urea system in 000 km. Otherwise vehicle will not start

Restarting the vehicle

Vehicle restart restriction	
Low urea level	Refill urea tank or vehicle will not start/Refill urea tank. Otherwise vehicle will not start
Urea system failure (= no urea injection)	Service urea system in 000 km or vehicle will not start/Service urea system in 000 km. Otherwise vehicle will not start
Incorrect urea detected (= abnormal urea)	Refill with correct urea in 000 km or vehicle will not start/Refill with correct urea in 000 km. Otherwise vehicle will not start
Abnormal urea consumption (= post treatment failure)	Service urea system in 000 km or vehicle will not start/Service urea system in 000 km. Otherwise vehicle will not start

The vehicle can be restarted after the problem is solved. If the 'Refill urea tank or vehicle will not start/Refill urea tank. Otherwise vehicle will not start' warning message appears, refill the urea solution tank. After refilling the tank, press the Engine Start/Stop button to the ON position and wait until the message disappears. If the vehicle cannot be restarted after refilling urea, we recommend that the system be inspected by an authorized retailer of Genesis Branded products.

Adding urea solution

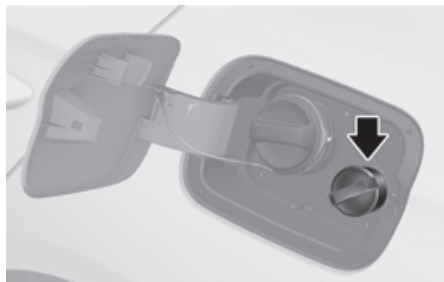

Refilling urea with a refill hose

1. Turn the vehicle off.
2. To open the urea solution tank cap, turn it counterclockwise.
3. Fully insert the refill hose and add urea. Do not overfill.
4. To close the urea solution tank cap, turn it clockwise.

Refilling urea from a refill bottle

1. Turn the vehicle off.
2. To open the urea solution tank cap, turn it counterclockwise.
3. Add urea. Do not overfill.
4. To close the urea solution tank cap, turn it clockwise.

Use only specified urea solution (Refer to the “Recommended lubricants and capacities” section in chapter 2).

NOTICE

To prevent damage to your vehicle:

- Use only specified urea solution. Never add any other urea solution than what has been specified.
- Be careful not to add urea solution into the fuel tank.
- While adding urea, be careful not to allow foreign substances to enter into the urea solution tank.
- Do not mix water or additives with the urea solution.
- Do not over fill the urea solution tank. In cold weather, the tank will expand if the urea freezes.

Storing urea solution

- Store urea solution only in containers made with the following materials.
 - DIN EN 10 088-1-/2-/3-specified CR-Ni steel
 - Mo-Cr-Ni steel
 - Polypropylene
 - Polyethylene
- Do not store urea solution in containers made with the following materials.
 - Aluminum, copper, copper alloy, non-alloyed still, and galvanized steel

Urea solution dissolves the metal materials, severely damaging the exhaust purification system.

i Information

Urea solution is a water-soluble substance, which is inflammable, non-toxic, colorless and odorless.

NOTICE

- The following situations may damage the DPF system.
 - Fuels or any unauthorized liquids are added to the urea solution tank
 - Additives are mixed in the urea solution
 - Water is mixed in the urea solution
 - Use only specified urea solution.
When any unauthorized urea solution is added to the tank, we recommend that you contact an authorized retailer of Genesis Branded products.
 - When any foreign substances enter the urea solution tank, the following problems may occur.
 - Increased emission
 - DPF system malfunction
 - Engine failure
 - Never add used urea solution as its quality cannot be guaranteed. Always add new urea solution.
-

WARNING

- Do not apply any external impact on the DPF system. It may damage the catalyst, which is equipped inside the DPF system.
- Do not modify the DPF system by redirecting or lengthening the exhaust pipe. It may adversely effect the DPF system.
- Avoid contact with the drained water from the exhaust pipe. The water is slightly acid and harmful to skin. If contacted, thoroughly wash it off.
- Any modification of the DPF system may cause system malfunction. The DPF system is controlled by a complex device.

- Wait for the DPF system to cool down before maintenance, as it is hot due to heat generation. Otherwise, it may cause skin burn.
 - The Selective Catalytic Reduction system (i.e. urea solution nozzle, urea solution pump, and DCU) operates for about 2 minutes more to eliminate the remaining urea solution inside, even after the engine is turned OFF. Before working on the vehicle, make sure that the Selective Catalytic Reduction system is completely turned OFF.
 - Poor urea solution or unauthorized liquids may damage vehicle components, including the DPF system. Any unverified additives in the urea solution may clog the SCR catalyst and cause other malfunctions, which require the expensive DPF system to be replaced.
-

⚠ WARNING

- When the urea solution contacts with the eyes or the skin, you should thoroughly wash the contaminated skin area.
- When you swallow the urea solution, thoroughly rinse your mouth and drink a lot of fresh water. Then, immediately consult a doctor.
- When your cloth is contaminated with the urea solution, immediately change your cloth.
- When you have an allergic reaction to the urea solution, immediately consult a doctor.
- Keep children away from urea solution.
- When opening the urea solution tank cap at high outside temperatures, ammonia vapors may escape. Ammonia vapors have a pungent smell and primarily cause irritation of the:
 - Skin
 - Mucous membranes
 - Eyes

You may experience a burning sensation in your eyes, nose and throat, as well as coughing and watering of the eyes. Do not inhale ammonia vapors. Do not allow urea solution to come in direct contact with your skin. It is hazardous to your health. Wash any affected areas off with plenty of clean water. If necessary, consult a doctor.
- When handling urea solution in closed space, ensure good ventilation. When the bottle of urea solution container is opened, pungent smelling fumes may escape

NOTICE

- Wipe off any urea solution spillage with water or dampened cloth. When the urea solution is crystalized, wipe it off with sponge or cloth, which is dampened in cold water.

When the urea solution spillage is exposed in the air for an extended period of time, it is crystalized in white, damaging the vehicle surface.
- When urea solution overflows onto vehicle surface, wash out vehicle surface with clean water to prohibit corrosion from occurring.
- Store the urea solution tank only in well ventilated locations. When urea solution is exposed to hot temperature at about 50°C (122°F) for an extended period of time (for example, under direct sunlight), chemical decomposition may occur, emitting ammonia vapor.
- In case the vehicle was parked at very low ambient temperature (below - 11 °C (12 °F) for a long time, the urea solution will be frozen in the urea solution tank. With frozen urea, the tank level may not be detected correctly until the urea solution melts. Incorrect urea or diluted urea may increase the freezing point, so only use specified urea solution.

The time for the urea solution to melt varies in accordance with driving conditions and outside temperatures.

Index

A

Accessing your vehicle	5-5
Immobilizer system	5-12
Smart key	5-5
Active air flap	6-60
Malfunction	6-61
Active hood lift system	3-67
System activation	3-67
System limitation	3-68
System malfunction	3-69
Air cleaner	9-37
Filter replacement	9-37
Air conditioner compressor label	2-29
Air conditioning system	2-21
Airbag - supplemental restraint system	3-48
Additional safety precautions	3-66
Airbag warning labels	3-66
How does the airbags system operate?	3-56
SRS care	3-65
What to expect after an airbag inflates	3-59
Where are the air bags?	3-51
Why didn't my airbag go off in a collision?	3-60
All Wheel Drive (AWD)	6-43
All Wheel Drive (AWD) operation	6-44
Emergency precautions	6-45
Appearance care	9-85
Exterior care	9-85
Interior care	9-91
Automatic climate control system	5-93
Automatic temperature control mode	5-95
Clean air system	5-104
Manual temperature control mode	5-96
System maintenance	5-109
System operation	5-107
Automatic transmission	6-10
Automatic transmission operation	6-11
Cluster display messages (cluster)	6-16
Good driving practices	6-22
Paddle shifter (Manual shift mode)	6-16

B

Battery	9-41
Battery capacity label	9-44
Battery recharging	9-44
Battery Replacement	9-43
For best battery service	9-42
Reset items	9-45
Before driving	6-3
Before entering the vehicle	6-4

Before starting	6-4
Blind-Spot Collision-Avoidance Assist (BCA)	7-30
Blind-Spot Collision-Avoidance Assist malfunction and limitations	7-36
Blind-Spot Collision-Avoidance Assist operation	7-34
Blind-Spot Collision-Avoidance Assist settings	7-32
Blind-Spot View Monitor (BVM)	7-62
Blind-Spot View Monitor malfunction	7-63
Blind-Spot View Monitor operation	7-63
Blind-Spot View Monitor settings	7-62
Brake fluid	9-34
Checking the brake fluid level	9-34
Braking system	6-23
Anti-lock Brake System (ABS)	6-35
Auto Hold	6-31
Brake assistant system (BAS)	6-42
Disc brakes wear indicator	6-24, 6-25
Electronic Parking Brake (EPB)	6-25
Electronic Stability Control (ESC)	6-36
Emergency Stop Signal (ESS)	6-40
Good braking practices	6-42
Hill-Start Assist Control (HAC)	6-40
Multi-Collision Brake (MCB)	6-41
Power brakes	6-23
Vehicle Stability Management (VSM)	6-39
Bulb wattage	2-18

C

Cabin air filter	9-38
Filter inspection	9-38
Filter replacement	9-38
Center Console Overview (I)	2-8
Center Console Overview (II)	2-10
Child Restraint System (CRS)	3-33
Installing a Child Restraint System (CRS)	3-36
Our recommendation: Children always in the rear	3-33
Selecting a Child Restraint System (CRS)	3-34
Climate control additional features	5-114
Air conditioning auto-drying	5-114
Auto defogging system	5-114
Auto dehumidify	5-116
Climate touchscreen haptic intensity	5-117
Recirculating air when washer fluid is used	5-116
Sunroof inside air recirculation	5-117
Warmer/ventilation based on climate settings (for driver's seat)	5-117
Cluster display (Type A)	4-35
Cluster display control	4-35
Option menu	4-41
View modes	4-35
Cluster display (Type B)	4-43
3D instrument cluster (for 12.3-inch 3D cluster)	4-50

Cluster display control	4-43
Trip computer	4-47
View modes	4-44
Coasting	6-54
Coasting operating conditions	6-54
Coasting release conditions	6-55
Coasting setting	6-54
Cruise Control (CC)	7-64
Cruise Control operation	7-64

D

Declaration of conformity	2-29, 7-139
Front radar	7-139
Rear corner radar	7-141
Dimensions	2-16
Door locks	5-13
Automatic door lock and unlock features	5-17
Child-protector rear door locks	5-17
Impact sensing door unlock system	5-16
Operating door locks from inside the vehicle	5-14
Operating door locks from outside the vehicle	5-13
Speed sensing door lock system	5-16
Drive mode integrated control system	6-56
Drive mode	6-56
Vehicle characteristic	6-59
Driver assistance system notice	7-4
Driver Attention Warning (DAW)	7-56
Driver Attention Warning malfunction and limitations	7-59
Driver Attention Warning operation	7-57
Driver Attention Warning settings	7-56

E

Electronic control suspension	6-47
System malfunction	6-47
Emergency commodity	8-34
Fire extinguisher	8-34
First aid kit	8-34
Tire pressure gauge	8-35
Triangle reflector	8-34
Emission control system	9-94
Crankcase emission control system	9-95
Diesel Particulate Filter (DPF)	9-97
Evaporative emission control system	9-95
Exhaust emission control system	9-95
Gasoline Particulate Filter (GPF)	9-96
Lean NOx Trap (for diesel engine)	9-98
Selective Catalytic Reduction (SCR) (for diesel engine)	9-98
Engine	2-17
Engine compartment	9-4

Engine Compartment Overview	2-14
Engine coolant	9-31
Changing coolant	9-33
Checking the coolant level	9-31
Engine number	2-28
Engine oil	9-27
Checking the engine oil and filter	9-30
Checking the engine oil level	9-27
Engine Start/Stop button	6-5
Engine Stop/Start button positions	6-6
Remote start	6-9
Starting the engine	6-7
Turning off the engine	6-8
Explanation of scheduled maintenance items	9-24
Air cleaner filter	9-25
Air conditioning refrigerant	9-26
Automatic transmission fluid	9-25
Brake discs, pads, calipers and rotors	9-26
Brake fluid	9-26
Brake hoses and lines	9-26
Cooling system	9-25
Drive belts	9-24
Drive shafts and boots	9-26
Engine coolant	9-25
Engine oil and filter	9-24
Exhaust pipe and muffler	9-26
Fuel filter (cartridge)(for diesel engine)	9-24
Fuel filter (for gasoline engine)	9-24
Fuel lines, fuel hoses and connections	9-24
Spark plugs (for gasoline engine)	9-25
Steering gear box, linkage & boots/lower arm ball joint	9-26
Suspension mounting bolts	9-26
Vapor hose and fuel filler cap	9-24
Exterior lights	5-72
Battery saver function	5-74
Daytime Running Light (DRL)	5-75
Headlight delay function	5-75
Headlight leveling device	5-75
Headlight moisture removal function	5-76
High beam operation	5-73
Lighting control	5-72
Puddle light	5-77
Rear fog light	5-74
Reverse guide light	5-75
Turn signals and lane change signals	5-74
Welcome system	5-76
Exterior overview (Front View)	2-2
Exterior overview (Rear View)	2-4

F

Foreword 1-2

Forward Collision-Avoidance Assist (FCA) (Sensor fusion) 7-4

Forward Collision-Avoidance Assist malfunction and limitations 7-15

Forward Collision-Avoidance Assist operation 7-9

Forward Collision-Avoidance Assist settings 7-6

Forward/Reverse Parking Distance Warning (PDW) 7-132

Forward/Reverse Parking Distance Warning malfunction and limitations 7-136

Forward/Reverse Parking Distance Warning operation 7-133

Forward/Reverse Parking Distance Warning settings 7-133

Fuel filler door 5-67

Closing the fuel filler door 5-68

Emergency fuel filler lid release 5-69

Opening the fuel filler door 5-67

Fuel filter (for diesel engine) 9-36

Draining water from fuel filter 9-36

Fuel filter cartridge replacement 9-36

Fuel label 2-30

Diesel engine 2-31

Gasoline engine 2-30

Fuel requirements 1-5

Diesel engine 1-8

Gasoline engine 1-5

Fuses 9-55

Engine compartment panel fuse replacement 9-57

Fuse/relay panel description 9-58

Instrument panel fuse replacement 9-56

G

Genesis brand motor company 1-2

H

Hazard warning flasher 8-3

Head-UP display (HUD) 5-70

Head-UP display information 5-70

Head-UP display settings 5-70

Precautions while using the Head-UP display 5-71

High Beam Assist (HBA) 5-81

High Beam Assist malfunction and limitations 5-82

High Beam Assist operation 5-82

High Beam Assist setting 5-81

Highway Driving Assist (HDA) 7-97

Highway Driving Assist malfunction and limitations 7-103

Highway Driving Assist operation 7-100

Highway Driving Assist settings 7-98

Hood 5-49

Closing the hood 5-50

Opening the hood 5-49

How to use this manual 1-3

Idle Stop and Go (ISG)	6-50
Calibrating the Battery Sensor	6-53
Forced to restart engine	6-52
ISG malfunction	6-53
ISG system off	6-52
ISG system operation	6-50
If the engine overheats	8-8
If the engine will not start	8-4
If you have a flat tire (with spare tire)	8-14
Changing tires	8-16
EC declaration of conformity for jack	8-21
Jack and tools	8-14
Jack label	8-20
If you have a flat tire (with Tire Mobility Kit)	8-22
Components of the Tire Mobility Kit	8-25
How to adjust tire pressure	8-29
Introduction	8-23
Notes on the safe use of the Tire Mobility Kit	8-23
Using the Tire Mobility Kit When a tire is flat	8-26
Important safety precautions	3-3
Airbag hazards	3-3
Always wear your seat belt	3-3
Control your speed	3-4
Driver distraction	3-3
Keep your vehicle in safe condition	3-4
Never drink or take drugs and drive	3-3
Restrain all children	3-3
In case of an emergency while driving	8-3
If the engine stalls at a crossroad or crossing	8-3
If the engine stalls while driving	8-3
If you have a flat tire while driving	8-4
Infotainment system	5-128
Antenna	5-129
Bluetooth® Wireless Technology	5-131
Infotainment system	5-130
Lexicon premium sound system	5-131
Steering wheel remote controls	5-130
USB Port	5-128
Voice recognition	5-131
Instrument cluster	4-2
Cluster display messages	4-29
Gauges and meters	4-4
Instrument cluster control	4-3
Transmission shift indicator	4-10
Warning and indicator lights	4-11
Integrated memory system	5-20
Recalling memory positions	5-21
Resetting the system	5-21
Seat easy access	5-22

Storing memory positions	5-20
Intelligent Front-Lighting System (IFS)	5-77
System malfunction and limitations	5-79
System operation	5-78
System setting	5-77
Intelligent Speed Limit Assist (ISLA)	7-49
Intelligent Speed Limit Assist malfunction and limitations	7-54
Intelligent Speed Limit Assist operation	7-52
Intelligent Speed Limit Assist settings	7-50
Interior features	5-120
Ashtray	5-121
Clock	5-126
Coat hook	5-126
Cup holder	5-120
Floor mat anchor(s)	5-126
Luggage net holder	5-127
Power outlet	5-122
Shopping holder	5-128
Sunvisor	5-121
USB charger	5-123
Wireless smartphone charging system	5-124
Interior lights	5-84
Front lamps	5-84
Glove box lamp	5-85
Interior lamp AUTO cut	5-84
Mood lamp/foot lamp	5-86
Rear lamps	5-85
Tailgate lamp (Shooting Brake)	5-87
Trunk lamp (Sedan)	5-87
Vanity mirror lamp	5-85
Interior overview (I)	2-6
Interior overview (II)	2-7

J

Jump starting	8-5
----------------------------	-----

L

Lane Following Assist (LFA)	7-91
Lane Following Assist malfunction and limitations	7-96
Lane Following Assist operation	7-92
Lane Following Assist settings	7-91
Lane Keeping Assist (LKA)	7-23
Lane Keeping Assist malfunction and limitations	7-28
Lane Keeping Assist operation	7-25
Lane Keeping Assist settings	7-23
Launch control	6-48
Launch Control activation	6-48
Limited use of Launch Control	6-49
Prerequisite for activation	6-48

Light bulbs	9-76
Headlight aiming	9-78
Headlight, Position light, Turn signal light, Daytime running light (DRL) replacement	9-77
High mounted stop light replacement	9-83
Interior light replacement	9-84
License plate light replacement	9-83
Puddle light replacement	9-81
Rear combination light replacement	9-82
Rear fog light replacement	9-82
Side repeater light replacement	9-81
Limited Slip Differential	6-47
Load and speed capacity tires (for Europe)	2-20

M

Maintenance services	9-7
Owner maintenance precautions	9-7
Owner's responsibility	9-7
Manual Speed Limit Assist (MSLA)	7-47
Manual Speed Limit Assist operation	7-47
Mirrors	5-27
Inside rearview mirror	5-27
Outside rearview mirrors	5-36
Reverse parking aid	5-38

N

Navigation-based Smart Cruise Control (NSCC)	7-85
Limitations of Navigation-based Smart Cruise Control	7-87
Navigation-based Smart Cruise Control operation	7-86
Navigation-based Smart Cruise Control settings	7-85
Non-Powered Trunk	5-50
Closing the trunk	5-51
Emergency trunk safety release	5-51
Opening the trunk	5-50

O

Open Source Software Notice	2-32
Owner maintenance	9-8
Owner maintenance schedule	9-9

P

Pan-European E-Call system (For Europe)	8-36
Information on data processing	8-39
Pan-European E-Call system	8-40
Power tailgate	5-57
Emergency tailgate safety release	5-63
Operating the power tailgate	5-59
Power tailgate operating conditions	5-57
Power tailgate settings	5-61
Resetting the power tailgate	5-62

Power trunk	5-52
Emergency trunk safety release	5-56
Operating the power trunk	5-54
Power trunk operating conditions	5-52
Resetting the power trunk	5-56
Setting the power trunk	5-56

R

Rear Cross-Traffic Collision-Avoidance Assist (RCCA)	7-117
Rear Cross-Traffic Collision-Avoidance Assist malfunction and limitations	7-123
Rear Cross-Traffic Collision-Avoidance Assist operation	7-119
Rear Cross-Traffic Collision-Avoidance Assist settings	7-118
Rear Occupant Alert (ROA)	5-19
Rear View Monitor (RVM)	7-105
Rear View Monitor malfunction and limitations	7-110
Rear View Monitor operation	7-107
Rear View Monitor settings	7-106
Recommended lubricants and capacities	2-23
Recommended SAE viscosity number	2-25
Returning used vehicles (for europe)	1-10
Reverse Parking Distance Warning (PDW)	7-127
Reverse Parking Distance Warning malfunction and limitations	7-129
Reverse Parking Distance Warning operation	7-128
Reverse Parking Distance Warning settings	7-128

S

Safe Exit Warning (SEW)	7-41
Safe Exit Warning malfunction and limitations	7-45
Safe Exit Warning operation	7-43
Safe Exit Warning settings	7-42
Safety messages	1-4
Scheduled maintenance services	9-10
Maintenance under severe usage conditions	9-22
Maintenance under severe usage conditions (except Europe, but including Russia)	9-15
Normal maintenance schedule (except Europe, but including Russia)	9-11
Normal maintenance schedule (for Europe, except Russia)	9-17
Seat belts	3-24
Additional seat belt safety precautions	3-31
Care of seat belts	3-33
Seat belt restraint system	3-27
Seat belt safety precautions	3-24
Seat belt warning light	3-25
Seats	3-5
Air ventilation seats	3-22
Front seats	3-9
Headrest	3-16
Rear seats	3-13
Safety precautions	3-8
Seat warmers	3-20

Semi active engine mount	6-60
Smart Cruise Control (SCC)	7-68
Smart Cruise Control malfunction and limitations	7-79
Smart Cruise Control operation	7-70
Smart Cruise Control settings	7-68
Smart trunk (or tailgate)	5-63
Deactivating smart trunk (or tailgate)	5-65
Detecting area	5-66
How to use the smart trunk (or tailgate)	5-64
Special driving conditions	6-61
Driving at night	6-63
Driving in flooded areas	6-64
Driving in the rain	6-63
Hazardous driving conditions	6-61
Highway driving	6-64
Rocking the vehicle	6-62
Smooth cornering	6-62
Steering wheel	5-23
Heated steering wheel	5-26
Horn	5-25
Motor Driven Power Steering (MDPS)	5-23
Tilt/Telescopic steering	5-24
Steering Wheel Control Overview	2-12
Storage compartment	5-118
Center console storage	5-118
Glove box	5-119
Sunglass holder	5-119
Surround View Monitor (SVM)	7-110
Surround View Monitor malfunction and limitations	7-116
Surround View Monitor operation	7-113
Surround View Monitor settings	7-111

T

Theft-alarm system	5-18
Tire Pressure Monitoring System (TPMS)	8-9
Changing a tire with TPMS	8-13
Check tire pressure	8-10
Low tire pressure position and tire pressure telltale	8-11
Low tire pressure warning light	8-11
Tire pressure monitoring system	8-10
Tire specification and pressure label	2-28
Tires and wheels	2-19, 9-46
Check tire inflation pressure	9-47
Low aspect ratio tires	9-54
Recommended cold tire inflation pressures	9-46
Tire care	9-46
Tire maintenance	9-50
Tire replacement	9-49
Tire rotation	9-48
Tire sidewall labeling	9-51

Tire traction	9-50
Wheel alignment and tire balance	9-49
Wheel replacement	9-50
Towing	8-30
Emergency towing	8-32
Removable towing hook	8-31
Towing service	8-30
TPMS (Tire Pressure Monitoring System) malfunction indicator	8-12
Trailer towing	6-70

V

Vehicle (infotainment system)	4-53
Setting your vehicle	4-53
Vehicle break-in process	1-10
Vehicle certification label	2-27
Vehicle Identification Number (VIN)	2-27
Vehicle modifications	1-9
Vehicle weight	6-69
Overloading	6-70
Vehicle weight and luggage volume	2-22

W

Washer fluid	9-35
Checking the washer fluid level	9-35
Wide sunroof	5-45
Automatic reversal	5-47
Power sunshade	5-45
Resetting the sunroof	5-48
Slide open/close	5-46
Sunroof open warning	5-49
Tilt open/close	5-46
Windows	5-40
Power windows	5-41
Remote window opening/closing function	5-44
Windshield defrosting and defogging	5-111
Defogging logic	5-112
Rear window defroster	5-113
To defog inside windshield	5-111
To defrost inside windshield	5-112
Winter driving	6-65
Snow or icy conditions	6-65
Winter precautions	6-67
Wiper blades	9-39
Blade inspection	9-39
Blade replacement	9-39
Wipers and washers	5-88
Front windshield washers	5-90
Front windshield wipers	5-89
Rear windshield wipers	5-92